

Source: SA5

Presentation of Specification to TSG SA

Presentation to:	TSG SA Meeting #6
Document for presentation:	3G TS 32.102 V2.0.0 <i>3G Telecom Management architecture</i>
Presented for:	Approval

Abstract of document:

This document identifies and standardises the most important and strategic contexts in the physical architecture for the management of UMTS. It serves as a framework to help define a telecom management physical architecture for a planned UMTS and to adopt standards and provide products that are easy to integrate.

It is applicable to all further Technical Specifications regarding the Telecom Management of UMTS.

Changes since last presentation to TSG-SA Meeting # 5

- Conformance conditions added
-

Outstanding Issues:

See list of outstanding R99 issues on the following page

Contentious Issues:

none identified

Release 1999 Submission form

Work Area / Item:		TS 32.102 - 3G Telecom Management architecture			
Affects:	UE/MS:	CN:	UTRAN:	Compatibility Issues:	Yes: No:
Expected Completion Date:		March 2000 for the outstanding issues mentioned below			
Services impacted:					
Specifications affected:					
Tasks within work which are not complete:			<ol style="list-style-type: none"> 1. Review IRP framework issues; 2. Resolve issue of consistency with TS 32.102 on X.25 as a network layer 		
Consequences if not included in Release 1999:					
Accepted by TSG: SA #6			for late inclusion in Release 1999:		

3G TS 32.102 V2.0.0 (1999-12)

Technical Specification

3rd Generation Partnership Project; Technical Specification Group Services and System Aspects; 3G Telecom Management architecture (3G TS 32.102 version 2.0.0)



The present document has been developed within the 3rd Generation Partnership Project (3GPP™) and may be further elaborated for the purposes of 3GPP. The present document has not been subject to any approval process by the 3GPP Organisational Partners and shall not be implemented. This Specification is provided for future development work within 3GPP only. The Organisational Partners accept no liability for any use of this Specification. Specifications and reports for implementation of the 3GPP™ system should be obtained via the 3GPP Organisational Partners' Publications Offices.

Reference

DTS/TSGS-0532102U

Keywords

TMN, Network Management, Telecom
Management

3GPP

Postal address

3GPP support office address

650 Route des Lucioles - Sophia Antipolis
Valbonne - FRANCE
Tel.: +33 4 92 94 42 00 Fax: +33 4 93 65 47 16

Internet

<http://www.3gpp.org>

Copyright Notification

No part may be reproduced except as authorized by written permission.
The copyright and the foregoing restriction extend to reproduction in all media.

© 1999, 3GPP Organizational Partners (ARIB, CWTS, ETSI, T1, TTA, TTC).
All rights reserved.

Contents

Foreword.....	5
1 Scope.....	6
2 References	6
2.1 Normative references	6
2.2 Informative references	6
3 Definitions, symbols and abbreviations.....	6
3.1 Definitions	6
3.2 Abbreviations.....	8
4 General.....	9
4.1 UMTS	9
4.1.1 UMTS Reference Model	9
4.1.2 UMTS Provisioning Entities	9
4.1.3 UMTS Management Infrastructure	9
4.2 TMN	10
5 General view of UMTS Management Physical architectures	10
6 Basic objectives for a UMTS Physical Architecture.....	11
7 TM Architectural aspects	11
7.1 Architectural relationship.....	11
7.2 Architectural constraints	12
7.3 Interoperability	12
7.3.1 Interfaces	13
7.3.2 Open systems approach.....	15
7.3.3 Level of openness.....	15
7.3.4 Closed interfaces	15
7.4 Data communication networks.....	16
7.5 New technologies.....	16
8 UMTS Management Physical architectures	17
8.1 Compliance Conditions.....	17
8.2 Network elements management architecture.....	17
8.3 Network & Subnetwork Element Management Architecture	19
8.4 Operations Systems interoperability architecture.....	20
8.5 Operations Systems intraoperability architecture.....	20
8.6 Business System interconnection architecture	21
9 TMN applications	22
10 Integration Reference Points	23
10.1 General.....	23
10.2 Integration levels.....	23
10.2.1 Application integration.....	24
10.3 Network infrastructure IRPs	24
10.2 Defining the IRPs.....	25
11 Implementation aspects	26
11.1 Layering of the OS applications.....	26
12 TMN planning and design considerations	26
12.1 Function attributes	27
12.2 Functional characteristics.....	27
12.3 Critical attributes	27
12.4 Protocol selection	28
12.5 Communications considerations	28

13	Mediation/Integration	28
	Annex A: (Informative) Technology considerations.....	30
A.1	TMN building blocks.....	30
A.1.1	Operations System (OS)	30
A.1.2	Mediation Device (MD).....	30
A.1.3	Q Adaptor (QA).....	30
A.1.4	Data Communication Network (DCN).....	30
A.1.5	Network Element (NE)	30
A.1.6	Workstation (WS).....	31
A.2	TMN standard interfaces	32
A.2.1	Q interface	32
A.2.2	F interface	33
A.2.3	X interface	33
	History.....	35

Foreword

This Technical Specification has been produced by the 3GPP.

The contents of the present document are subject to continuing work within the TSG and may change following formal TSG approval. Should the TSG modify the contents of this TS, it will be re-released by the TSG with an identifying change of release date and an increase in version number as follows:

Version x.y.z

where:

- x the first digit:
 - 1 presented to TSG for information;
 - 2 presented to TSG for approval;
 - 3 Indicates TSG approved document under change control.
- y the second digit is incremented for all changes of substance, i.e. technical enhancements, corrections, updates, etc.
- z the third digit is incremented when editorial only changes have been incorporated in the specification;

1 Scope

The present document identifies identify and standardises the most important and strategic contexts in the physical architecture for the management of UMTS. It serves as a framework to help define a telecom management physical architecture for a planned UMTS and to adopt standards and provide products that are easy to integrate.

This present document is applicable to all further Technical Specifications regarding the Telecom Management of UMTS.

2 References

2.1 Normative references

- [1] ITU-T Recommendation M.3010 (1996): "Principles for a telecommunications management network".
- [2] 3G TS 32.101 "3G Telecom Management principles and high level requirements"
- [3] ITU-T Recommendation Q.811 (1993), Lower layer protocol profiles for the Q3 interface.
- [4] ITU-T Recommendation X.200 (1994), Information technology – Open Systems Interconnection – Basic reference model: The basic model.
- [5] CCITT Recommendation M.3400 (1992), TMN management functions.
- [6] TeleManagement Forum, SMART TMN Technology Integration Map, GB909 (1998)

2.2 Informative references

- [20] TMF GB910. Smart TMN Telecom Operations Map (Release 1.1)
- [21] TMF GB909. Smart TMN Technology Integration Map (Issue 1.1)

3 Definitions, symbols and abbreviations

3.1 Definitions

For the purposes of the present document, the following definitions apply:

Architecture: The organisational structure of a system or component, their relationships, and the principles and guidelines governing their design and evolution over time.

Closed interfaces: Privately controlled system/subsystem boundary descriptions that are not disclosed to the public or are unique to a single supplier.

De facto standard: A standard that is widely accepted and used but that lacks formal approval by a recognised standards organisation.

Interface standard: A standard that specifies the physical or functional interface characteristics of systems, subsystems, equipment, assemblies, components, items or parts to permit interchangeability, interconnection, interoperability, compatibility, or communications.

Interoperability: The ability of two or more systems or components to exchange data and use information.

Intraoperability: The ability to interchange and use information, functions and services among components within a

system.

IRP Information Model: An IRP Information Model consists of an IRP Information Service and a Resource Model (see below for definitions of IRP Information Service and Resource Model).

IRP Information Service: An IRP Information Service describes the information flow and support objects for a certain functional area, e.g. the alarm information service in the fault management area. As an example of support objects, for the Alarm IRP there is the alarm record and alarm list.

IRP Solution Set: An IRP Solution Set is a mapping of the IRP Information Service to one of several technologies (CORBA/IDL, SNMP/SMI, CMIP/GDMO, etc.). An IRP Information Service can be mapped to several different IRP Solution Sets. Different technology selections may be done for different IRPs.

Management Infrastructure: The collection of systems (computers and telecommunications) a UMTS Organisation has in order to manage UMTS.

Market Acceptance: Market acceptance means that an item has been accepted in the market as evidenced by annual sales, length of time available for sale, and after-sale support capability.

Modular: Pertaining to the design concept in which interchangeable units are employed to create a functional end product.

Module: An interchangeable item that contains components. In computer programming, a program unit that is discrete and identifiable with respect to compiling, combining with other modules, and loading is called a module.

Open Specifications: Public specifications that are maintained by an open, public consensus process to accommodate new technologies over time and that are consistent with international standards.

Open Standards: Widely accepted and supported standards set by recognised standards organisation or the commercial market place. These standards support interoperability, portability, and scalability and are equally available to the general public at no cost or with a moderate license fee.

Open Systems Architecture (OSA): An architecture produced by an open systems approach and employing open systems specifications and standards to an appropriate level.

Open Systems Strategy: An open systems strategy focuses on fielding superior telecom capability more quickly and more affordably by using multiple suppliers and commercially supported practices, products, specifications, and standards, which are selected based on performance, cost, industry acceptance, long term availability and supportability, and upgrade potential.

Physical Architecture: A minimal set of rules governing the arrangement, interaction, and interdependence of the parts or elements whose purpose is to ensure that a conformant system satisfies a specified set of requirements. The physical architecture identifies the services, interfaces, standards, and their relationships. It provides the technical guidelines for implementation of systems upon which engineering specifications are based and common building blocks are built.

Plug&play: Term for easy integration of HW/SW.

Portability: The ease with which a system, component, data, or user can be transferred from one hardware or software environment to another.

Proprietary Specifications: Specifications which are exclusively owned by a private individual or corporation under a trademark or patent, the use of which would require a license.

Reference Model: A generally accepted abstract representation that allows users to focus on establishing definitions, building common understandings and identifying issues for resolution. For TMN Systems acquisitions, a reference model is necessary to establish a context for understanding how the disparate technologies and standards required to implement TMN relate to each other. A reference model provides a mechanism for identifying the key issues associated with applications portability, modularity, scalability and interoperability. Most importantly, Reference Models will aid in the evaluation and analysis of domain-specific architectures.

Resource Model: A protocol independent model describing managed objects representing network resources, e.g. an RNC or NodeB.

Scalability : The capability to adapt hardware or software to accommodate changing work loads.

Specification: A document that prescribes, in a complete, precise, verifiable manner, the requirements, design, behaviour, or characteristics of a system or system component.

Standard: A document that establishes uniform engineering and technical requirements for processes, procedures, practices, and methods. Standards may also establish requirements for selection, application, and design criteria of material.

Standards Based Architecture: An architecture based on an acceptable set of open standards governing the arrangement, interaction, and interdependence of the parts or elements that together may be used to form a TMN System, and whose purpose is to insure that a conformant system satisfies a specified set of requirements.

System : Any organised assembly of resources and procedures united and regulated by interaction or interdependence to accomplish a set of specific functions.

System Architecture: A description, including graphics, of systems and interconnections providing for or supporting management functions. The SA defines the physical connection, location, and identification of the key nodes, circuits, networks, platforms, etc., and specifies system and component performance parameters. It is constructed to satisfy Operational Architecture requirements per standards defined in the Physical Architecture. The SA shows how multiple systems within a subject area link and interoperate, and may describe the internal construction or operations of particular systems within the architecture.

UMTS Organisation: A legal entity that is involved in the provisioning of UMTS.

3.2 Abbreviations

For the purposes of the present document, the following abbreviations apply:

BG	Border Gateway
BSC	Base Station Controller
BSS	Base Station Subsystem
BTS	Base Transceiver Station
CIM	Common Information Model Specification (from DMTF)
CMIP	Common Management Information Protocol
CMISE	Common Management Information Service
CORBA	Common Object Request Broker Architecture
FM	Fault Management
FTAM	File Transfer, Access and Management
F/W	Firewall
GGSN	Gateway GPRS Support Node
HLR	Home Location Register
HTTP	HyperText Transfer Protocol
IDL	Interface Definition Language
IIOP	Internet Inter-ORB Protocol
IRP	Integration Reference Point
IWU	Inter Working Unit
MD	Mediation Device
MIB	Management Information Base
MIM	Management Information Model
MMI	Man-Machine Interface
MML	Man-Machine Language
MSC	Mobile Service Switching Centre
NE	Network Element
NSS	Network Switching Subsystem
NW	Network
OS	Operations System
OSF	Operations System Functions
PSTN	Public Switched Telephone Network
QA	Q-Adapter
OMG	Object Management Group
QoS	Quality of Service
SGSN	Serving GPRS Support Node

SLA	Service Level Agreement
SMI	Structure of Management Information (RFC 1155)
SNMP	Simple Network Management Protocol
TL1	Transaction Language 1
TM	Telecom Management
TMN	Telecommunications Management Network as defined in ITU-T Recommendation M.3010 [1].
UML	Unified Modelling Language
VLR	Visitor Location Register
WBEM	Web Based Element Management
WS	Workstation

4 General

4.1 UMTS

4.1.1 UMTS Reference Model

A Universal Mobile Telecommunications System is made of the following components:

- 1 or more Access Networks, using different types of access techniques (GSM, UTRA, DECT, PSTN, ISDN, ...) of which at least one is UTRA;
- 1 or more Core Networks;
- 1 or more Intelligent Node Networks, service logic and mobility management, (IN, GSM ...);
- 1 or more transmission networks (PDH, SDH etc) in various topologies (point-to-point, ring, point-to-multipoint etc) and physical means (radio, fiber, copper etc).

The UMTS components have signalling mechanisms among them (V5, A, DSS1, INAP, MAP, #7, RSVP etc).

From the service perspective, the UMTS is defined to offer:

- service support transparent to the location, access technique and core network, within the bearer capabilities available in one particular case;
- user to terminal and user to network interface (MMI) irrespective of the entities supporting the services required (VHE);
- multimedia capabilities.

4.1.2 UMTS Provisioning Entities

UMTS 22.01 – "Service Aspects; Services Principles" identifies two major entities which cover the set of UMTS functionalities involved in the provision of the UMTS services to the user. These are:

Home Environment. This entity holds the functionalities that enable a user to obtain UMTS services in a consistent manner regardless of the user's location or the terminal used.

Serving Network. This entity provides the user with access to the services of the Home Environment

4.1.3 UMTS Management Infrastructure

Every UMTS Organisation has its own Management Infrastructure. Each Management Infrastructure will contain different functionality depending on the role played and the equipment used by that UMTS Entity.

However the core management architecture of the UMTS Organisation is very similar. Every UMTS Organisation:

- provides services to its customers;

- needs an infrastructure to fulfil them (advertise, ordering, creation, provisioning, ...);
- assures them (Operation, Quality of Service, Trouble Reporting and Fixing, ...);
- bills them (Rating, Discounting, ...).

Not every UMTS Organisation will implement the complete Management Architecture and related Processes. Some processes may be missing dependent on the role a particular UMTS Organisation is embodying. Processes not implemented by a particular UMTS Organisation are accessed via interconnections to other UMTS organisations which have implemented these processes (called X-interfaces in the TMN architecture).

The Management architecture itself does not distinguish between external and internal interfaces.

4.2 TMN

TMN (Telecommunications Management Network), as defined in [1], provides:

- an architecture, made of OS (Operations Systems) and NEs (Network Elements), and the interfaces between them (Q3, within one Operator Domain and X, between different Operators)
- the methodology to define those interfaces
- other architectural tools such as LLA (Logical Layered Architecture) that help to further refine and define the Management Architecture of a given management area
- a number of generic and/or common management functions to be specialised/applied to various and specific TMN interfaces

The UMTS Management Architecture is largely based on TMN, and will reuse those functions, methods and interfaces already defined (or being defined) that are suitable to the management needs of UMTS. However, the UMTS Management needs to explore the incorporation of other concepts (other management paradigms widely accepted and deployed) since:

- UMTS incorporates other technologies to which TMN is not applied fully
- UMTS faces new challenges that TMN does not address today

It must be noted, that these concerns are applicable to other telecommunication areas as well as to UMTS, it is expected that the eventual evolution of TMN will cover this ground. Indeed, most of the above concepts are already being taken into account by TMN evolution (protocols and methodologies).

5 General view of UMTS Management Physical architectures

Telecom Management Architectures can vary greatly in scope and detail. The architecture for a large service provider, with a lot of existing legacy systems and applications, upon which many services are based, will be of high complexity. In contrast, the architectural needs of a start-up mobile operator, providing its services to a small group of valueadd Service Providers, will be much less and will probably focus on more short term needs.

A mobile network operator has to manage many different types of networks as radio networks, exchanges, transmission networks, area networks, intelligent nodes and substantial amounts of computer hardware/software. This wide variety of network equipment must be obtained from a variety of equipment vendors. The nature of a mobile radio network will be heterogeneous and will present a number of operational difficulties for the service provider on enabling effective and efficient network management.

The standardisation work for the management of UMTS has adopted the top-down approach and will from business needs identify functional and informational architectures. The physical architecture will have to meet these requirements and as there are many ways to build a UMTS it will vary greatly from one TMN solution to another. There will be many physical implementations as different entities will take different roles in a UMTS.

It is obvious that it will not be meaningful or even possible to fully standardise a common telecom management physical architecture for UMTS. This document will identify and standardise the most important and strategic contexts and serve as a framework to help define a physical architecture for a planned UMTS.

6 Basic objectives for a UMTS Physical Architecture

The management of UMTS will put a lot of new requirements to the management systems compared to the second generation of Mobile telephony. Some of the challenging requirements affecting the physical architecture are

- To be capable of managing equipment supplied by different vendors.
- To enable TM automation in a more cost efficient way - TM optimised for maximum efficiency and effectiveness.
- To provide UMTS configuration capabilities that are flexible enough to allow rapid deployment of services.
- To report events and reactions in a common way in order to allow remote control.
- To allow interoperability between Network Operators/Service Providers for the exchange of management/charging information
- To be scaleable and applicable to both larger and small deployments.
- Accessibility to information
- To profit from advances and standards in IT and datacom industry.

The second generation of mobile networks can from management point of view be characterised as the era of net element vendor dependent NE managers. The different OSs had very low interoperability with other systems and functional blocks could rarely be re-used. The Mobile Telecom Management Networks were far away from the TMN vision where one vendors OS should be able to manage other vendors net elements.

For UMTS Management it is clearly stated the necessity of cost-effective solutions and better time to market focus. Interoperability, scaleability and re-use are keywords for the new generation of management systems.

Many of the new requirements on the management of UMTS can only be solved by defining and establish a suitable physical architecture. Thou it is not possible to standardise the one single UMTS TM physical architecture, it is evidently so that the success of a telecom management network of a UMTS will heavily depend on critical physical architectural issues. This document will identify those architectural critical issues.

7 TM Architectural aspects

7.1 Architectural relationship

The basic aspects of a TM architecture which can be considered when planning and designing a TM network are:

- The functional architecture
- The information architecture
- The physical architecture

The management requirements from the business needs will be the base for the functional architecture which will describe the functions that have to be achieved. The information architecture defines what information that has to be provided so the functions defined in the functional architecture can be achieved. The physical architecture have to meet both the functional architecture and the information architectures. Other constraints from reality will also have impact to the physical architecture as cost, performance, legacy systems and all preferences any operator will have on a big capital investment as a TM network.

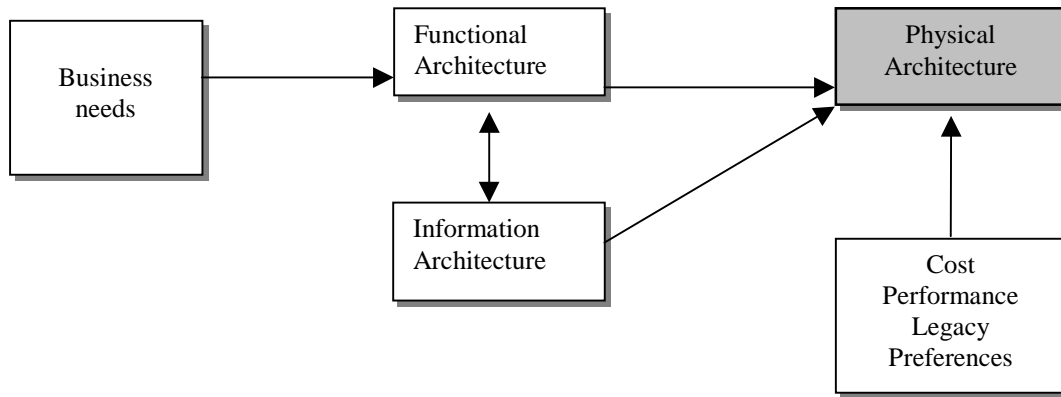

Figure 1: Architectural relationship

7.2 Architectural constraints

Large software systems, such as a network management system, is a capital investment operators cannot afford to scrap every time its requirements change. Network operators are seeking cost-effective solutions to their short term needs. All these reality related issues are vital constraints that must be addressed in the definition of the architecture.

The standardisation of UMTS will bring new and different services that will add new demands on network management. Every UMTS organisation will include different functionality depending on the role played and the equipment used by that UMTS entity. Regulation may force some of the roles that must be taken. The need to link systems across corporate boundaries will be a consequence of this.

The rapid evolution of new services and technologies will also put requirements on the UMTS physical management architecture to accommodate market and technology trends. To future-proof investments and continuously be able to take advantage of new technologies are important constraints to the physical architecture.

A UMTS TMN must also adopt an architecture that will achieve scalability and extensibility of systems and networks so the TMN can grow as the services expands over time. To start with a small TMN and easily be able to expand the TMN after new requirements will be important issues for most UMTS operators.

The telecom management network will be just one part of the overall business of a company. System management, general security issues and development strategies can be the target for company policies. System architectures and technology choices, as well as the availability of off-the-shelf commercial systems and software components that fulfil the requirements established in this specification, may be critical to an operator's implementation of the specified UMTS management architecture.

7.3 Interoperability

The new requirement on a UMTS TMN will imply a focus change from net element management towards management of information "information management". Network providers make use of different information in several different ways which also may vary from network to network and from time to time. Basic information as alarms is of course essential information for localising faults but may also be the key information to be able to set up a service with a service level agreement.

Numerous of different interfaces can be identified in a UMTS network in the areas of network element management, network management and service management. The most important and complex of these interfaces will be standardised but many interfaces of less importance are unlikely to be fully standardised and will be up to the individual operator and vendor to develop. To adopt mainstream computing technologies, re-use widely used protocols, standards and an open system architecture will be essential to secure interworking between all physical entities in a UMTS.

Low-cost and general access to management systems information will be needed. Obviously this is the critical issue and challenging task in the heterogeneous, distributed and complex network of a UMTS.

7.3.1 Interfaces

A UMTS will consist of many different types of components based on different types of technologies. There will be access-, core-, transmission- and intelligent node networks and many of the UMTS components have already been the target for Telecom Management standardisation at different levels. Many of these standards will be reused and the management domain of a UMTS will thereby consist of many TMNs. A architectural requirement for UMTS management must be to support distributed TMN's and TMN-interworking on peer to peer basis.

The Telecom Management Architecture can vary greatly in scope and detail, because of scale of operation and that different organisations may take different roles in a UMTS (see chapter 5). The architecture of UMTS TMN's must provide a high degree of flexibility to meet the various topological conditions as the physical distribution and the number of NEs. Flexibility is also required to allow high degree of centralization of personnel and the administrative practices as well as allowing dispersion to administrative domains (see further chapter 10). The 3G Telecom Management architecture must be such that the NEs will operate in the same way, independently of the OS architecture.

The following common NE Management Domains can be identified in a UMTS

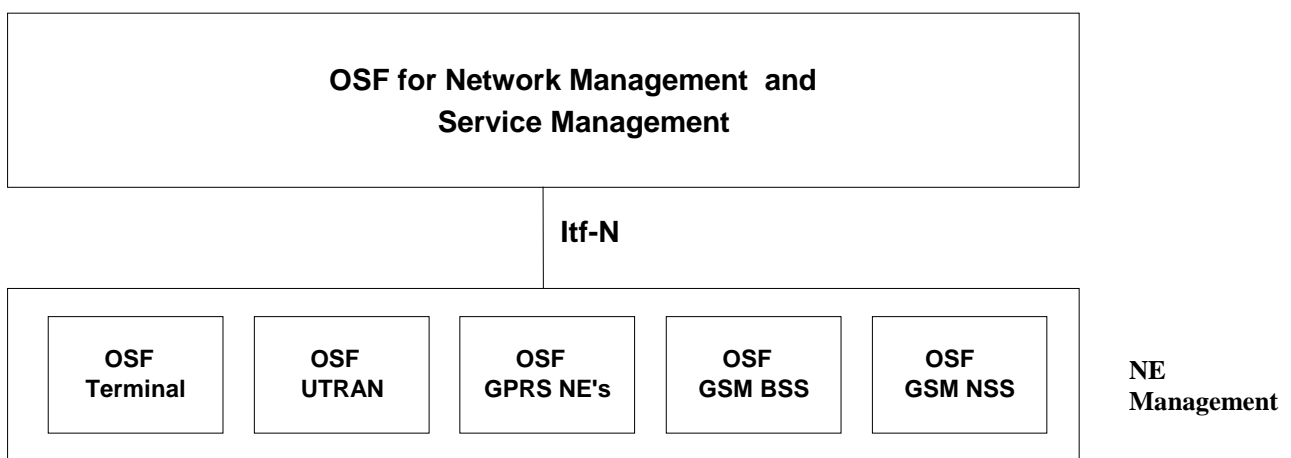

Figure 2: Overview of the UMTS Telecom Management Domains

Itf-N between the NE OSFs and NM/SM OSFs. This could be used by the network- and service management systems to transfer management messages, notifications and service management requests via the NE OSF to the network elements. This interface must be open and the information models standardised.

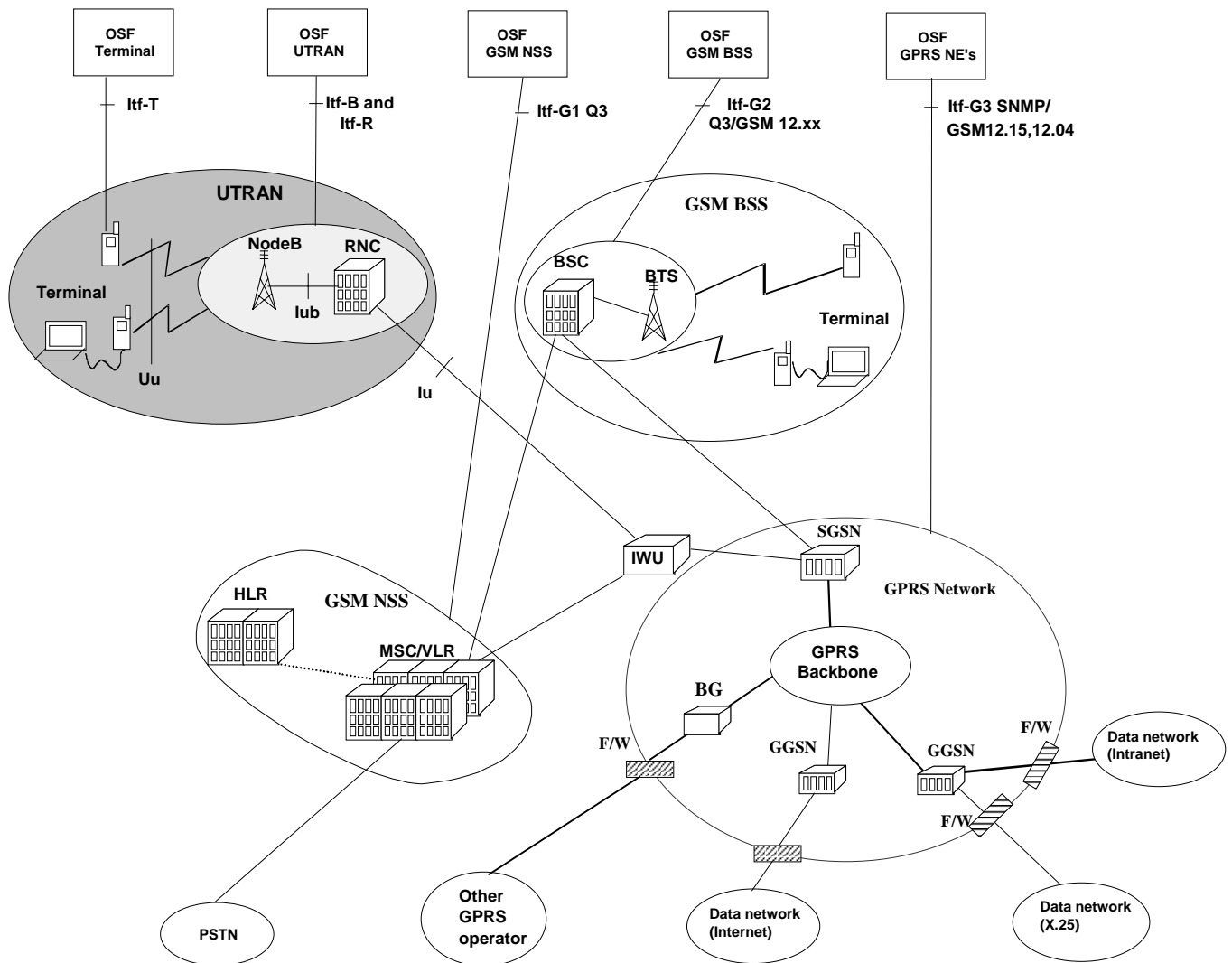

Figure 3: Overview of the UMTS Network Element Management Domains and interfaces

- Itf-T between a terminal and a NE Manager. This interface will in some extent manage the 3G terminal and the USIM of the subscriber. Requirements of this interface are for further study.
- Itf-B and Itf-R between UTRAN and a NE Manager.
- Itf-G1 between GSM NSS and NE Manager.
- Itf-G2 between GSM BSS and NE Manager. This interface is standardised in GSM 12-series specifications.
- Itf-G3 between GPRS NEs and a NE Manager. This interface is based on SNMP, GSM 12.15 (charging) and GSM 12.04 (performance management).

Telecom management interfaces may be considered from two perspectives:

- the management information model
- the management information exchange

The management information models will be standardised in other 3GPP documents but the management information exchange will be further described in this architectural standard.

The management task will vary greatly between different network elements in a UMTS. Some NEs are of high complexity e.g. a RNC, while others e.g. a border gateway is of less complexity. Different application protocols can be chosen to best suite the management requirements of the different Network Elements and the technology used.

Application protocols can be categorised out of many capabilities as:

- Functionality;
- Implementation complexity;
- Processor requirements;
- Cost efficiency;
- Market acceptance, availability of “off the shelf commercial systems and software”.

For each telecom management interface that will be standardised by 3GPP at least one of the accepted protocols will be recommended. Accepted application protocols (e.g. CMIP,SNMP,CORBA IIOP) are defined in [2] , Annex A.

7.3.2 Open systems approach

Even in the second generation of mobile radio networks the operators has to cope with heterogeneous environments in many different ways. No single vendor is likely to deliver all the management systems needed for a mobile operator.

The many different types of network elements, some with very high management complexity as an exchange and some less complex as a repeater system, are generally supported with unique vendor specific management systems with very low interoperability. Duplicated TMN applications is an other obvious reality of this generation of management systems. This will be further discussed under Chapter 9 (TMN Applications).

The new UMTS requirements call for open systems that can be supported by the marketplace, rather than being supported by a single (or limited) set of suppliers, due to the unique aspects of the design chosen. Open systems architectures are achieved by having the design focus on commonly used and widely supported interface standards. This should ensure costs and quality that are controlled by the forces of competition in the marketplace.

The open systems approach is a technical and business strategy to:

- Choose commercially supported specifications and standards for selected system interfaces
- Build systems based on modular hardware and software design

Selection of commercial specifications and standards in the Open systems approach should be based on:

- Those adopted by industry consensus based standards bodies or de facto standards (those successful in the market place)
- Market research that evaluates the short and long term availability of products
- Tradeoffs of performance
- Supportability and upgrade potential within defined cost constraint
- Allowance for continued access to technological innovation supported by many customers and a broad industrial base

7.3.3 Level of openness

The level the interfaces conform to open standards are critical for the overall behaviour. A low level of openness will severely impact on long-term supportability, interoperability, development lead-time, life cycle cost and overall performance.

Interfaces are expensive parts in a TMN and interfaces with low level of openness severely impacts on development lead-time for the introduction of any system, application component or service. Easy implementation (plug & play) is a requirement for UMTS TMN physical entities and requires a high the level of openness .

7.3.4 Closed interfaces

Many second generation mobile network physical management entities have vendor controlled system/subsystem

boundary descriptions that are not disclosed to the public or are unique to this single supplier - closed interfaces.

In a UMTS network, such interfaces will not fulfil the basic requirements and can not be a part of a UMTS TMN.

Closed interfaces can only be used as internal interfaces where no information whatsoever has to be shared to other physical management entities.

7.4 Data communication networks

Within a TMN, the necessary physical connection (e.g. circuit-switched or packet-switched) may be offered by communication paths constructed with all kinds of network components, e.g. dedicated lines, packet-switched data network, ISDN, common channel signalling network, public-switched telephone network, local area networks, terminal controllers, etc. In the extreme case the communication path provides for full connectivity, i.e. each attached system can be physically connected to all others.

The TMN should be designed such that it has the capability to interface with several types of communications paths, to ensure that a framework is provided which is flexible enough to allow the most efficient communications:

- between NE and other elements within the TMN;
- between WS and other elements within the TMN;
- between elements within the TMN;
- between TMNs;
- between TMNs and enterprise.

In this case the term efficiency relates to the cost, reliability and maintainability of the data transported.

Costs are impacted by two aspects. The first is the actual cost to transport data across the network between the TMN and the NE. The second aspect is the design of the interface including the selection of the appropriate communications protocol.

Whatever standardised protocol suite at the networking level that is capable of meeting the functional and operational requirements (including the network addressing aspects) of the Logical and Application Protocol levels of a given UMTS management interface, is a valid Networking Protocol for that interface.

A number of requirements shall be met by the Networking Protocol, as follows:

- Capability to run over any bearer (leased lines, X.25, ATM, Frame Relay, ...)
- Support of existing transport protocols and their applications, such as OSI, TCP/IP family, etc.
- Widely available, cheap and reliable.

The Internet Protocol (IP) is a Networking Protocol that ideally supports these requirements. IP also adds flexibility to how management connectivity is achieved when networks are rolled out, by offering various implementation choices. For instance, these may take the form of:

- Dedicated management intranets.
- Separation from or integration into an operator's enterprise network.
- Utilisation, in one way or another, of capacities of the public Internet and its applications or other resources.

7.5 New technologies

Meeting application requirements in the most affordable manner is together with development lead-time important issues identified in early UMTS management standardisation work. But the TMN functional, information and physical architectures must also keep pace with the introduction of new technologies, services and evolving network infrastructures. Technology is advancing so rapidly today that this must be a fundamental part of the physical architecture – to be able to easily adopt new important technologies.

A UMTS will need to incorporate new successful technologies from the IT-world to which TMN standardisation is not fully applicable. Today distributed computing implementations have matured to a point where the goals of TMN can be realised using commonly available technologies for a reasonable cost.

Widely accepted open standards and new IT-technologies will be indispensable to fulfil the challenging managing requirements of UMTS.

New technologies in the IT business as generic application components together with distributed processing technology are new important drivers upon application design of management systems. The possibility to purchase functional components from the open market are of great importance from many aspects as cost-efficiency and time-to-market.

8 UMTS Management Physical architectures

A UMTS Telecom Management Network will consist of many different management layers and many different building blocks. The complexity will vary greatly in detail because every organisation has different needs. The following chapter will identify the most critical architectural issues and compliance conditions for a given UMTS Management Interface. It should serve as fundamental requirements for any UMTS entity (network element or management system) being a part of a UMTS TMN.

8.1 Compliance Conditions

For a UMTS entity (Management System or NE) to be compliant to a given UMTS Management Interface, all the following conditions must be satisfied:

- 1) It implements the management functionality following the Information Model and flows specified by the relevant 3GPP UMTS Management Interface Specifications applicable to that interface
- 2) It provides at least one of the IRP Solution Sets (were available) related to the valid Application Protocols specified by 3GPP UMTS Application Protocols for that interface,[2] Annex C..
- 3) It provides at least one standard networking protocol
- 4) In case the entity does not offer the management interface on its own, a Q-Adaptor must be provided. This Q-Adaptor must be provided independently of any other UMTS NE and/or UMTS Management System.
- 5) Support for Bulk Transfer Application Protocols (i.e. FTAM, ftp and tftp) [2].

8.2 Network elements management architecture

The following figure demonstrates two possible options for management interface from the OS upper layers to NE. Option 1, provides access to the NE via element manager, and Option 2, provides a direct access. It is sufficient to provide one or the other.

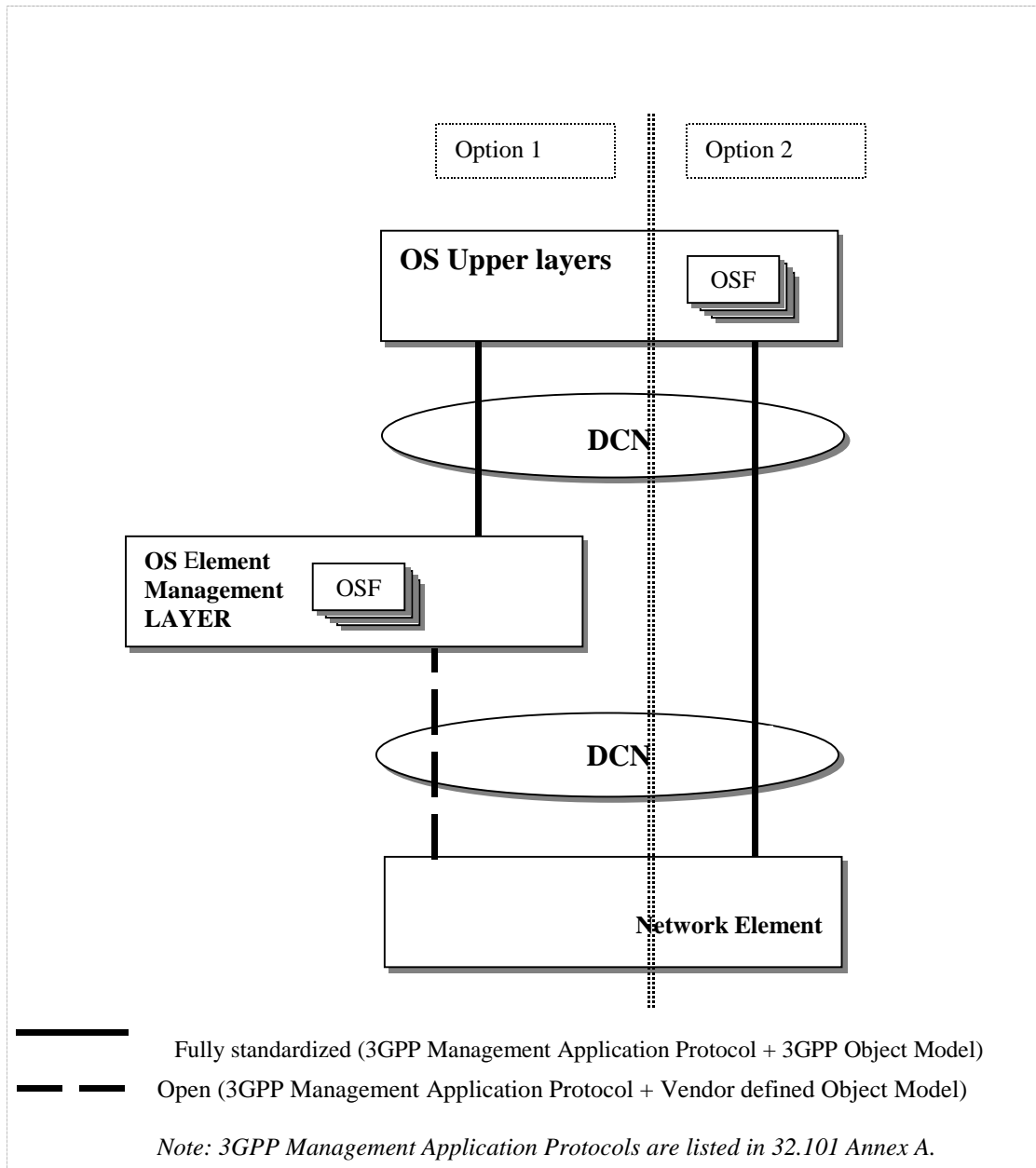

Figure 4: Network Element Management Architecture

For a UMTS entity (network element or management system) to be compliant to a given UMTS Management Interface the following conditions shall all be satisfied.

Item	Compliance conditions
1	Implements relevant 3GPP UMTS Management Information Model and flows
2	Application protocol (e.g. CMIP,SNMP,CORBA IIOP) defined in [2] , Annex A Implements relevant IRP Solution Sets, if available for that application protocol. (Defined in [2], Annex C)
3	Internet Protocol (IP)
4	Lower protocol levels required by Item 1,2 and 3

Any other entity taking part in a UMTS, as an implementation choice, shall satisfy the following condition:

Item	Compliance conditions
1	Not standardised but open

8.3 Network & Subnetwork Element Management Architecture

(Example UMTS RNC / NodeB)

An important special case of the network element management architecture is where one type of network element as the RNC will need management information for coordination of a subnetwork of other types of network elements as NodeB.

This management information shared between the RNC and NodeB will not reach the operators and is not considered to be a part of the UMTS TMN. All other management information related to NodeB will transparently be transferred by the RNC towards the UMTS TMN.

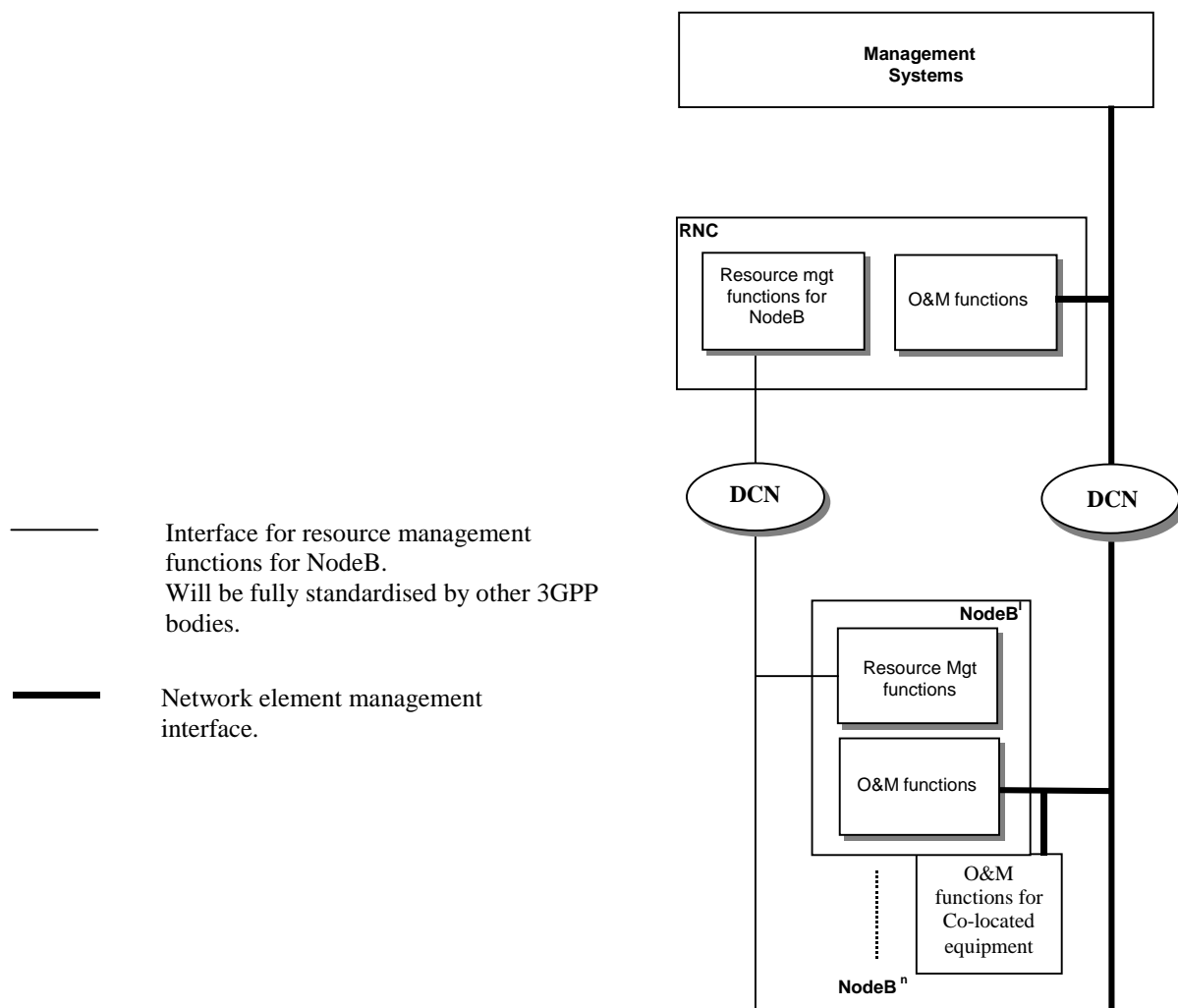

Figure 5: Network and Subnetwork Management Architecture

For a UMTS entity (network element, subnetwork element or management system) to be compliant to a given UMTS Management Interface the following conditions shall be satisfied.

Item	Compliance conditions
1	Implements relevant 3GPP UMTS Management Information Model and flows
2	Application protocol (e.g. CMIP,SNMP,CORBA IIOP) defined in [2] , Annex A Implements relevant IRP Solution Sets, if available for that application protocol. (Defined in [2], Annex C)
3	Internet Protocol (IP)
4	Lower protocol levels required by Item 1,2 and 3

8.4 Operations Systems interoperability architecture.

Interoperability between operations systems is an important issue in a UMTS. Different organisations may take different roles in a UMTS. The need to share information across corporate boundaries will be a consequence of this.

The heterogeneous, distributed and complex network of a UMTS will be a market for many different vendors. All operations systems has to interoperate and must be able to share information. This is a critical issue in the management of third generations systems.

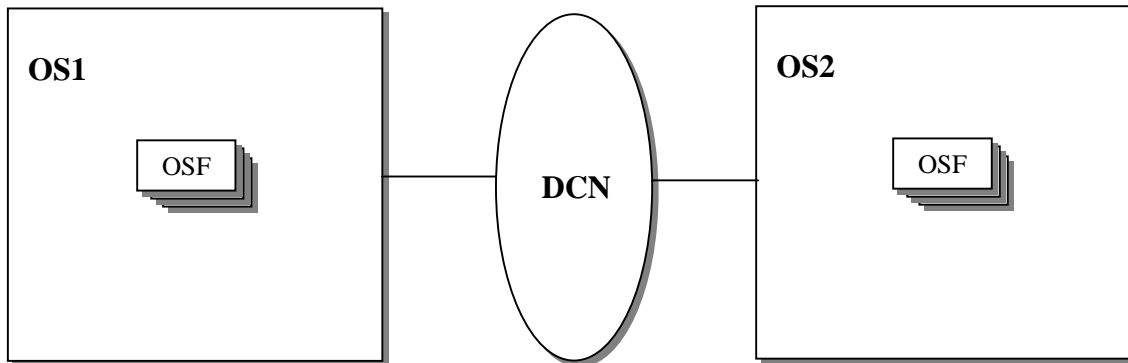

Figure 6: Operations Systems interoperability Architecture

For a Operations System to be UMTS TMN compliant the following conditions shall all be satisfied.

Item	Compliance conditions
1	Implements relevant 3GPP UMTS Management Information Model and flows
2	Application protocol (e.g. CMIP,SNMP,CORBA IIOP) defined in [2] , Annex A Implements relevant IRP Solution Sets, if available for that application protocol. (Defined in [2], Annex C)
3	Internet Protocol (IP)
4	Lower protocol levels required by Item 1,2 and 3

8.5 Operations Systems intraoperability architecture

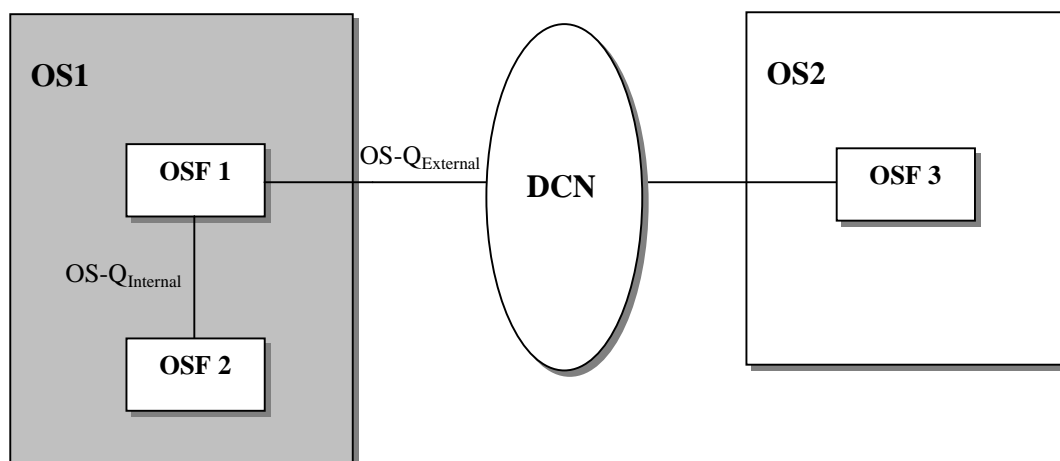

Figure 7: Operations Systems intraoperability Architecture

OS-Q_{Internal} indicates an internal flow and should to be compliant with a given UMTS Management Interface satisfy the following conditions:

Item	Compliance conditions
1	Implements relevant 3GPP UMTS Management Information Model and flows
2	Application protocol (e.g. CMIP,SNMP,CORBA IIOP) defined in [2] , Annex A Implements relevant IRP Solution Sets, if available for that application protocol. (Defined in [2], Annex C)

OS-Q_{External} indicates an external flow and shall to be compliant to a given UMTS Management Interface satisfy the following conditions:

Item	Compliance conditions
1	Implements relevant 3GPP UMTS Management Information Model and flows
2	Application protocol (e.g. CMIP,SNMP,CORBA IIOP) defined in [2] , Annex A Implements relevant IRP Solution Sets, if available for that application protocol. (Defined in [2], Annex C)
3	Internet Protocol (IP)
4	Lower protocol levels required by Item 1,2 and 3

8.6 Business System interconnection architecture

The business management layer has in the second generation systems a very low degree of standardisation. Operators have legacy systems or more IT influenced systems often adopted to every organisations different needs. Business systems is not a part of a UMTS TMN.

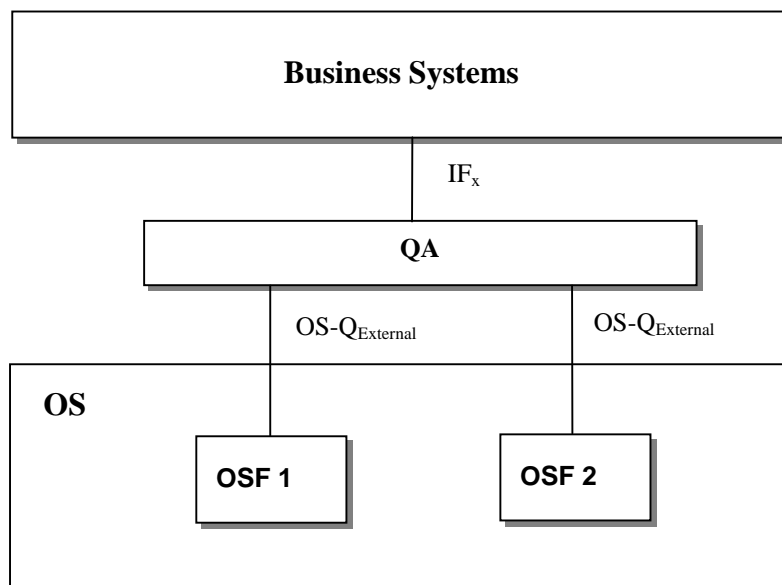

Figure 8: Business Systems interconnection architecture

OS-Q_{External} Indicates an external flow and shall to be compliant to a given UMTS Management Interface satisfy the following conditions:

Item	Compliance conditions
1	Implements relevant 3GPP UMTS Management Information Model and flows
2	Application protocol (e.g. CMIP,SNMP,CORBA IIOP) defined in [2] , Annex A Implements relevant IRP Solution Sets, if available for that application protocol. (Defined in [2], Annex C)
3	Internet Protocol (IP)
4	Lower protocol levels required by Item 1,2 and 3

IF_x indicates an external flow and shall to be compliant to a given UMTS Management Interface satisfy the following condition:

Item	Compliance conditions
1	Not standardised but open

9 TMN applications

Telecom management applications can be implemented in many different ways depending on constraints presented in previous sections of this technical specification. Consistent operational processes are required for the management of the network irrespective of vendor equipment. A mobile operator can because of the very heterogeneous nature of their networks easily end up with dozens of duplicated applications for e.g. alarm surveillance. Most vendors of network equipment offer dedicated network element managers and the ones not built with an open system approach will severely limit the possibility to report and manage the network in a consistent way.

Network element vendors with closed and unique network element managers or operations systems with closed interfaces or interfaces with low level of openness will not fulfil the basic requirements as a part of a UMTS. It will not be possible to design and build the telecom management network to support the operational processes as required. Such physical entities are not under consideration in this technical specification.

Many TM application functions can be identified as generic functions used by all major types of telecom equipment. Alarm surveillance applications and performance analysing applications are generic necessities to manage most network elements. Security and system management applications are also common to many TM components and may be the scope for overall business policies.

To identify and specify the design criteria that will allow re-usable application components to be developed across multiple telecom business scenarios are important issues to fulfil the basic UMTS Management requirement "To minimise the costs of managing a UMTS network such that it is a small component of the overall operating cost".

The implication of the top down approach in the standardising work of UMTS is that consistent operational management processes are required irrespective of vendor equipment.

Generic management applications are required to facilitate:

- Reduced management application development costs
- Simplification of operational processes and associated reduction in costs
- Reduced time to deploy new services as management systems already exist
- Consistent representation of basic information

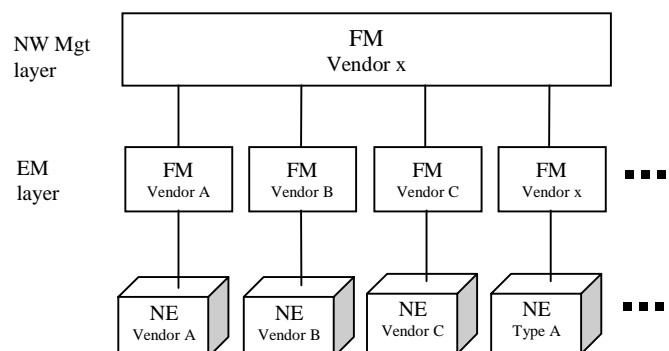

Figure 9: Unique NE fault management

Figure 9 represents a very common situation in the management of second generation of mobile networks. Different vendors supplied their network elements with unique network element managers. The interfaces were mostly proprietary or unique. The information models for generic information as alarms were rarely standardised. All together the consequence for the operators became very complex. Similar information at many levels, repeated acknowledgement of alarms, inconsistent representation of similar information are a few of all the difficulties the operators had to cope with.

Some of the more severe implications of this situation is the difficulty to add more intelligence into the applications to

better support the processes of the network providers. The operators who tried to brake up this situation had to put in a lot of effort into software development and proprietary interfaces. The marketplace did not support the needs of the operators.

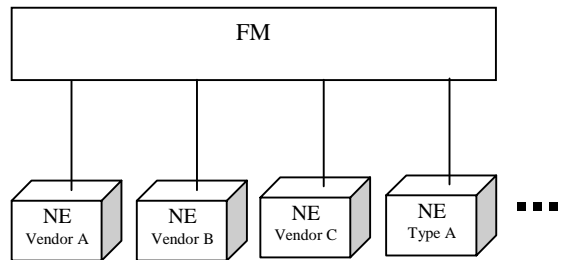

Figure 10: Generic fault management

Figure 10 indicates the situation where the telecom management process alarm surveillance is supported by a generic application for fault management. A common information model and accessibility to all related information will make it possible to add more intelligence to the management systems and to better support the management task.

TMN application functions as billing information collection or configuration management of a specialised network element are examples of application that can be identified as unique applications. Even these applications will need to interoperate with other applications and will also need the open system approach to be a part of a UMTS TMN. With a network with many different types of network elements a common graphical user interface as a web browser for configuration management applications could be an important issue to create consistent operational processes.

The complexity and heterogeneous nature of UMTS calls for easy integration (plug&play) of HW/SW.

10 Integration Reference Points

10.1 General

Relating to the OSI functional areas "FCAPS", IRPs are here introduced addressing parts of "FCAPS" – Fault, Configuration, Performance, and Security management. Comparing with TMF TOM (Telecom Operations Map), the introduced IRPs address process interfaces at the EML-NML (Element Management Layer – Network Management Layer) boundary. In 3GPP/SA5 context, this can also be applied to the "N-interface" between EM-NM and NE-NM.

The three cornerstones of the IRP concept are:

- **Top-down, process-driven modeling approach**
The purpose of each IRP is automation of one specific task, related to TMF TOM. This allows taking a "one step at a time" approach with a focus on the most important tasks.
- **Protocol-independent modeling**
Each IRP consists of a protocol-independent model (the IRP information model) and several protocol-dependent models (IRP solution sets).
- **Standard based protocol dependent modeling**
Models in different IRP solution sets (CMIP, SNMP, WBEM, ...) will be different as existing standard models of the corresponding protocol environment need to be considered. This means that solution sets largely need to be "hand crafted".

10.2 Integration levels

Virtually all types of telecom/datacom networks comprise many different technologies purchased from several different vendors. This implies that the corresponding management solution need to be built by integrating product-specific applications from different vendors with a number of generic applications that each provide some aspect of multi-vendor and/or multi-technology support. A complete management solution is thus composed of several independent

applications.

The following levels of integration are defined:

- **Screen Integration:** Each application provides its own specific graphical user interface (GUI) that need to be accessible from a single, unified screen (a common desktop). A seamless integration between the various GUIs is then required. Screen Integration will not be standardised in this Technical Specification.
- **Application Integration:** Applications need to interwork, on a machine-machine basis, in order to automate various end-to-end processes of a communication provider.

10.2.1 Application integration

Interfaces related to application integration can be divided in the following three categories:

- **High-level generic interfaces** between generic applications on the network and service management layers. The same approach and concepts apply for these as the next category:
- **High-level (technology-independent to the extent possible) interfaces** between product-specific and generic applications are needed in order to automate and streamline frequently occurring tasks applicable to several types of network elements. A top-down approach shall be taken when defining these interfaces, where the main input is (1) business processes of a communication provider, and (2) the types of generic applications that are used to implement the process support. The interfaces need to be stable, open and (preferably) standardised. These IRPs are discussed below under the heading Network Infrastructure IRPs.
- **Detailed (product-specific) interfaces** between product-specific applications and the corresponding network elements are of course also needed. These interfaces are defined using the traditional bottom-up approach, where the actual network infrastructure is modelled. This is the traditional TMN approach to element management. The management information in these interfaces is not further discussed in this document, as it is internal to a specific development organisation and does not need to be open. In fact, by publishing the management information in these interfaces, too much of the internal design may be revealed and it may become impossible to later enhance the systems that are using the interfaces. The management services (operations and notifications) and protocol shall however be open and standardised as long as they are independent of the MIM describing the managed NEs/NRs.

10.3 Network infrastructure IRPs

When providing integrated management solutions for multi-vendor networks, there is a strong requirement that the NEs and the management solutions that go together with them are systems integrable. It is here proposed that the telecom vendors provide a set of Network Infrastructure IRPs.

It should be noted that these IRPs could be provided by either the NE, or the Network Element Manager (EM) or Sub-Network Manager (SNM) that goes together with the type of NE. There is actually not a clear distinction any more between NE and element management applications, mainly due to the increased processing capacity of the equipment platforms. Embedded Element Managers providing a web user interface is a common example of that.

These IRPs are introduced to ensure interoperability between product-specific applications (PSA) and the types of generic applications shown in the figure below. These IRPs are considered to cover the most basic needs of task automation.

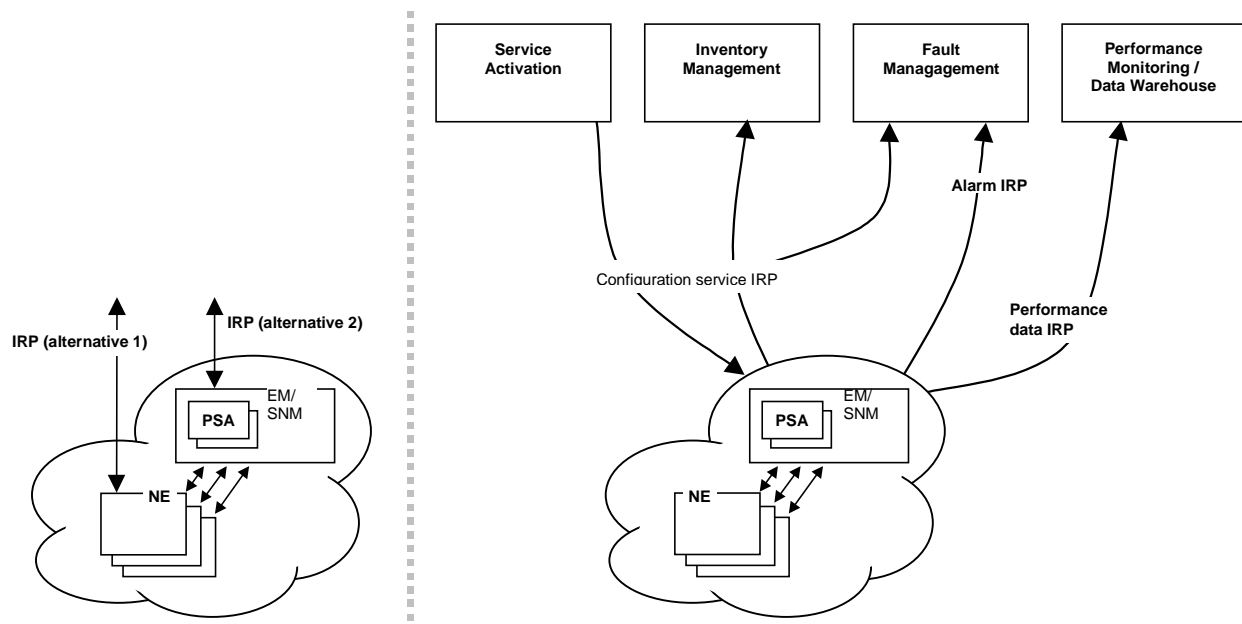

Figure 11: IRPs for application integration

The following gives examples of some basic IRPs:

The most basic need of a fault management (FM) application is to support alarm surveillance. Product-specific applications need to supply an *Alarm IRP* to forward alarms from all kinds of NEs and equipment to the FM application.

A *Configuration Service IRP* is needed for retrieval of the configuration and status of the corresponding network elements. It can also be used by inventory management applications, to track individual pieces of equipment and related data, as well as for all types of Configuration Management e.g. Service Activation applications, as a provisioning interface for frequent configuration activities that require automation.

Performance monitoring (PM) information is made available through the *Performance Data IRP*.

It is realised that the alarm IRP, performance data IRP, and configuration service IRP all have similar needs to use notifications. The corresponding service is formalised as a *Notification IRP*. It specifies: firstly, an interface through which subscriptions to different types of notifications can be set up (or cancelled), and secondly, common attributes among all notifications.

Further, applying a common *Name Convention for Managed Objects* is useful for co-operating applications that require identical interpretation of names assigned to network resources under management.

10.4 Defining the IRPs

It is important to avoid dependency on one specific technology, as the technologies will change over time. Applications need to be future-proof; One fundamental principle for achieving this is to clearly separate information models from protocols for the external interfaces, where the information models are more important than the selection of protocols.

Thus, the detailed IRP specifications are divided into two main parts, following the directives from TMF's SMART TMN:

- *Information models* specified with an implementation neutral modelling language. The Unified Modelling language (UML) has been selected, as it is standardised (by OMG), supported by most object oriented tools and used in several ongoing standardisation efforts (CIM, etc.)
- *Solution sets*, i.e. mappings of the information models to one or several protocols (CORBA/IDL, SNMP/SMI, CMIP/GDMO, COM/IDL, etc.). Different protocol selections may be done for different IRPs.

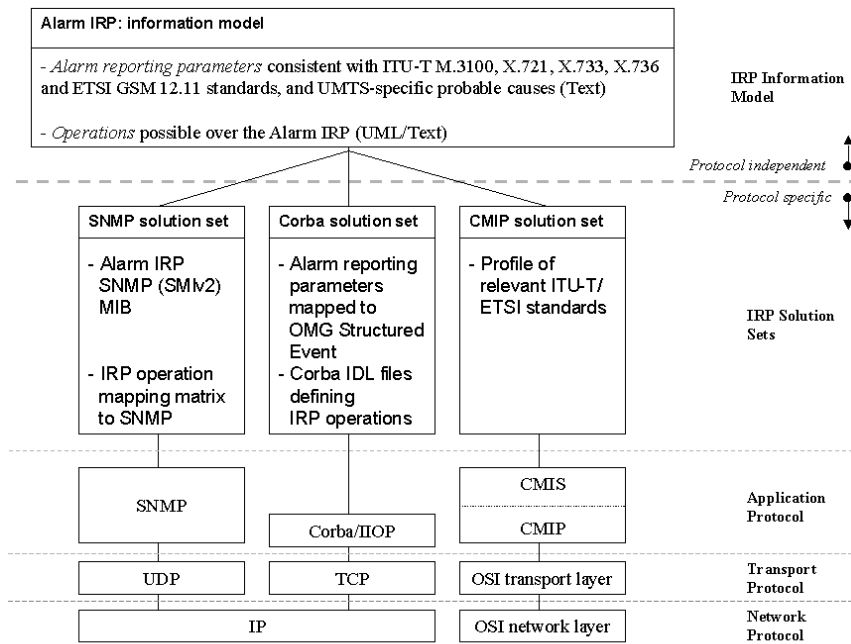

Figure 12: IRP example

11 Implementation aspects

11.1 Layering of the OS applications

UMTS operators might categorise and organise its operation systems in many different ways as:

- A national fault and performance OS
- A national charging, billing and accounting OS
- Regional configuration OS
- Regional fault, performance and configuration OS
- etc

This geographical dependent categorisation may change after time and the growth of the network. A physical architecture based on an open system design and re-usable application components would ease the work to adopt such structural changes. A management system build for a UMTS must provide the possibility of layering the applications.

12 TMN planning and design considerations

A TMN should be designed such that it has the capability to interface with several types of communications paths to ensure that a framework is provided which is flexible enough to allow for the most efficient communications:

- Between one NE and other elements within the TMN;
- Between a WS and other elements within the TMN;
- Between elements within the TMN;
- Between TMNs.

The basis for choosing the appropriate interfaces, however, should be the functions performed by the elements between

which appropriate communications are performed. The interface requirements are specified in terms of function attributes needed to provide the most efficient interface.

12.1 Function attributes

- a) *Reliability* – The capability of the interface to ensure that data and control are transferred such that integrity and security are maintained.
- b) *Frequency* – How often data is transferred across the interface boundary (Normal behaviour)
- c) *Quantity* – The amount of data that is transferred across the interface during any transaction.
- d) *Priority* – Indicates precedence to be given to data in case of competition for network resources with other functions.
- e) *Availability* – Determines the use of redundancy in the design of the communications channels between interfacing elements.
- f) *Delay* – Identifies the amount of buffering that may be tolerable between interfacing elements. This also impacts communications channel designs.

Table 1 suggests a table of possible ranges for these function attributes.

Table 1: Possible ranges for TMN function attributes [1]

Attributes		Requirements	Nature of attributes
Performance or grade of service (P)	Delay (speed)	Short Medium Long	Objective of design and control (acceptable/unacceptable but available/unavailable)
	Reliability (accuracy)	High Medium Low	
	Availability	High Medium Low	
Characteristics of TMN traffic (C)	Quantity	Large Medium Small	Condition or parameter of design
	Frequency	Often continuous Periodic Sparse	
	Priority	High Medium Low	

12.2 Functional characteristics

Each major type of telecommunications equipment has functional characteristic needs that can be used to describe the complexity of the interface.

There are, however, a basic group of TMN application functions that cross all major types of telecommunications equipment. There are also unique TMN application functions that are performed by specific categories of major telecommunications equipment. Alarm surveillance is an example of the former, whereas billing information collection is an example of the latter.

Functional characteristics of the elements within a TMN, e.g. OS, DCN and MD also describe the complexity of interfaces between these elements.

12.3 Critical attributes

Attribute values for a given function are generally consistent across the network elements.

When considering a single interface, it is important to identify the controlling attribute ranges for the design of the interface.

If there are conflicting attribute values for different functions in a given network element, more than one instance of an interface may be needed.

Overall TMN attribute values for the interfacing of elements within the TMN depend on the type and number of functions performed within these elements. In this case the functions are not consistent across TMN elements, but are controlled by the individual TMN design of an Administration.

12.4 Protocol selection

In many cases, more than one protocol suite will meet the requirements for the network element or TMN element under consideration. It is the approach for the 3GPP Telecom management standardisation to concentrate on protocol independent information models, allowing the mapping to several protocol suites.

The rationale behind this is:

- The blurring of Information and Telecommunication technologies in UMTS, it is required to work on a more open approach (acknowledging the market status and foreseen evolutions)
- The life-cycle of information flows is 10 to 20 years, while the protocols is 5 to 10 years
- The developments on automatic conversion allows for a more pragmatic and open approach

The choice of the individual protocol from the recommended family will be left open to the vendors and operators.

To provide the most efficient interface care should be taken to select the protocol suite that optimizes the relationship between the total cost to implement that protocol suite, the functional attributes and the data communications channels that carry the information across the interface.

12.5 Communications considerations

DCN architectures must be planned and designed to ensure that their implementation provides appropriate degrees of availability and network delay while minimizing cost.

One must consider the selection of communications architectures, e.g. star, multipoint, loop, tree.

The communications channels, e.g. dedicated lines, circuit-switched networks and packet networks used in providing the communications paths, also play an important role.

13 Mediation/Integration

The increase in the need to incorporate a hybrid set of technologies, multiple protocols and heterogeneous resources requires the availability of open management interfaces between the management systems and the different network resources. These interfaces require an underlying mechanism to mediate - interpret, translate, and handle data - between the various data representations and protocols. A set of Technology Integration Points [6] can be identified and will need to be supported.

Software components on the open market as automatic conversion applications, gateways, mediation applications will be valuable products to fulfil the challenging task to incorporate multiple protocols and heterogeneous resources.

In the figure below are Technology Integration Points summarised for some technologies:

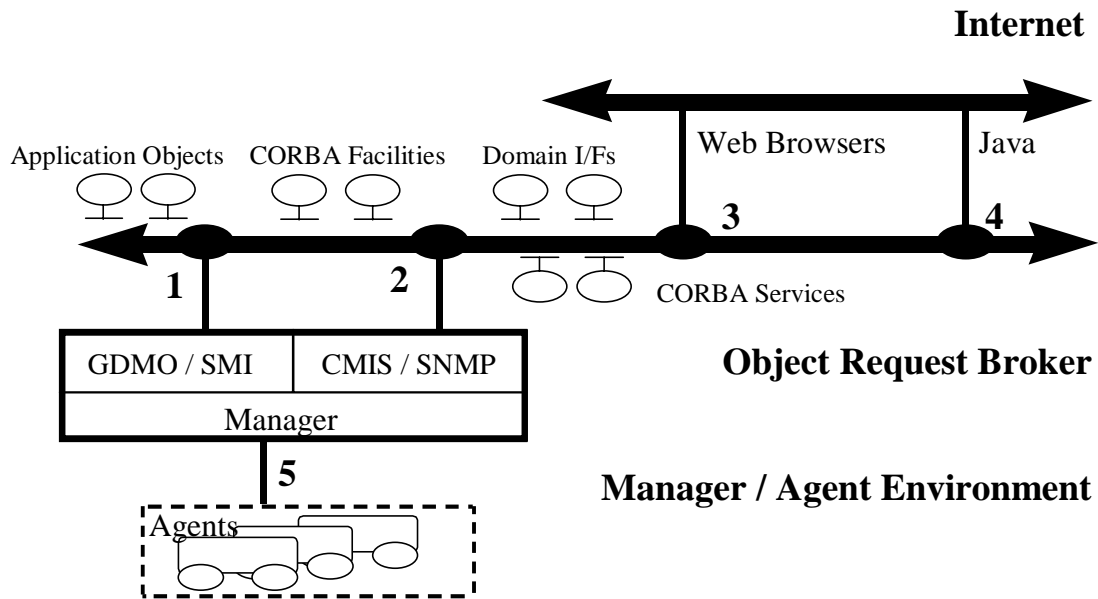

Figure 13: Technology Integration Points [21]

Essentially, this figure indicates that from the technologies selected, three technology areas will need to be integrated. These are:

- Internet/Web based services;
- Object Request Broker (CORBA) based services;
- Telecom based Manager/Agent services (i.e. CMIP/GDMO and SNMP/SMI).

In order to provide adequate points of integration between these areas of technology, five Integration Points (IPs) have been identified - as outlined in the table and in text form below:

Table 2: Technology Integration Points [21]

	Managed Objects (GDMO/SMI)	Management Services (CMISE/SNMP)	Java Objects	Web Browser (HTTP/HTML)	TMN Agent
CORBA Objects	IP1		IP4	IP3	
CORBA Services		IP2			
TMN Manager					IP5
IP1	Provides mapping of objects defined in CORBA/IDL to managed objects defined in GDMO or SMI.				
IP2	Provides mapping of appropriate CORBA Services to CMIS and SNMP services.				
IP3	Provides a mapping of Web Browser technology access to CORBA objects (for situations where this may be needed as an addition to/replacement of Browser access to a database).				
IP4	Provides a mapping between Java based objects and CORBA objects.				
IP5	Provides a high level convenient programming interface for the rapid development of TMN based manager/agent interactions. It also provides a convenient point of integration if it is necessary to separate out the two sides of the manager/agent interface from the point of view of technology selection. For example, allowing the manager role to perhaps be supported in a Web-based environment, but giving a good point of integration with a TMN based agent.				

Annex A: (Informative) Technology considerations

A.1 TMN building blocks

TMN functions can be implemented in a variety of physical configurations [M.3010]. The relationship of the functional blocks to physical equipment is shown in Table 3 which names the TMN building blocks according to the set of function blocks which each is allowed to contain. For each building block there is a function block which is characteristic of it and is mandatory for it to contain. There also exist other functions which are optional for the building blocks to contain. Table 3 does not imply any restriction of possible implementations, but defines those identified within this Recommendation.

The subclauses below give the definitions for consideration in implementation schemes.

A.1.1 Operations System (OS)

The OS is the system which performs OSFs. The OS may optionally provide MFs, QAFs and WSFs.

A.1.2 Mediation Device (MD)

The MD is the device which performs MFs. The MD may also optionally provide OSFs, QAFs and WSFs.

MDs can be implemented as hierarchies of cascaded devices.

A.1.3 Q Adaptor (QA)

The QA is a device which connects NE-like or OS-like with non-TMN compatible interfaces (at m reference points) to Q_x or Q₃ interfaces.

A.1.4 Data Communication Network (DCN)

The DCN is a communication network within a TMN which supports the DCF. The DCN represents an implementation of the OSI layers 1 to 3, which include any relevant ITU-T (formerly CCITT) or ISO standards for layers 1 to 3. The DCN provides no functionality at layers 4 to 7.

The DCN may consist of a number of individual subnetwork(s) of differing types, interconnected together. For example, the DCN may have a backbone subnetwork(s) that provides TMN-wide connectivity between a variety of subnetwork(s) providing local access to the DCN. The various types of subnetworks may include technology specific subnetwork(s) such as the SDH DCC.

A.1.5 Network Element (NE)

The NE is comprised of telecommunication equipment (or groups/parts of telecommunication equipment) and support equipment or any item or groups of items considered belonging to the telecommunications environment that performs NEFs. The NE may optionally contain any of the other TMN function blocks according to its implementation requirements. The NE has one or more standard Q-type interfaces and may optionally have F and X interfaces.

Existing NE-like equipment that does not possess a TMN standard interface will gain access to the TMN via a Q Adaptor Function, which will provide the necessary functionality to convert between a non-standard and standard management interface.

A.1.6 Workstation (WS)

The WS is the system which performs WSFs. The workstation functions translate information at the f reference point to a displayable format at the g reference point, and vice versa.

If equipment incorporates other TMN functionality as well as the WSF, then it is named by one of the other names in Table 3.

Table 3. Relationship of TMN building block names to TMN function blocks

(Notes 2 & 3)	NEF	MF	QAF	OSF	WSF
NE	M	O	O	O	O (Note 3)
MD		M	O	O	O
QA			M		
OS		O	O	M	O
WS					M
M Mandatory O Optional NOTES 1 Within this table, where more than one name is possible, the choice on the building block name is determined by the predominant usage of the block. 2 TMN building blocks may contain additional functionality which allows them to be managed. 3 For the WSF to be present either the MF or OSF must also be present. This means that the WSF must address an OSF or a MF. The local man-machine access is not considered part of the TMN.					

A.2 TMN standard interfaces

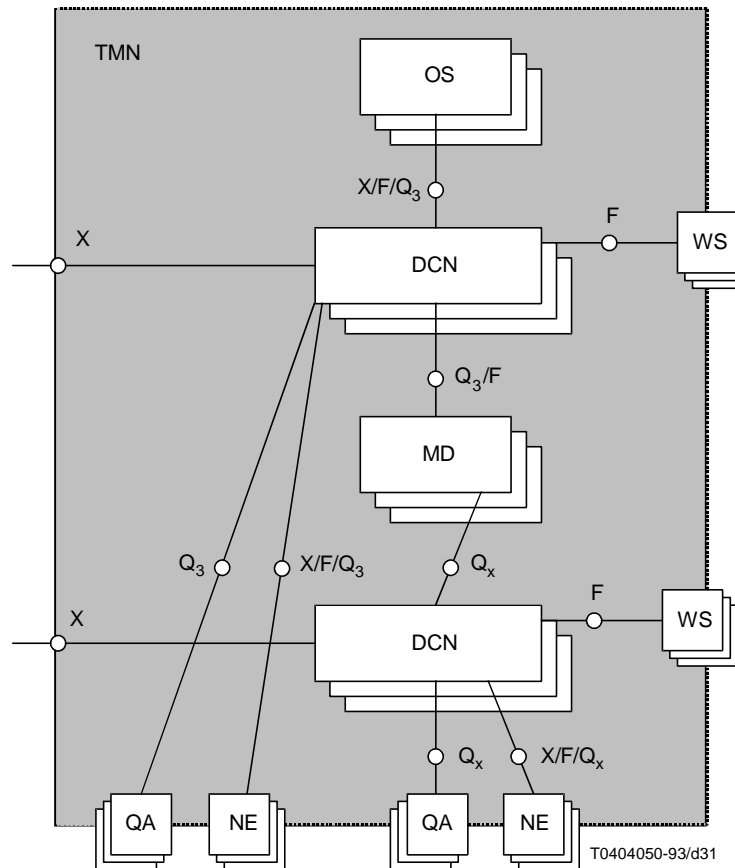

Figure 14. Examples of interfaces for the TMN physical architecture M.3010

Figure 12 shows the interconnection of the various TMN building blocks by a set of standard interoperable interfaces. The allowable interconnections of these standard interfaces within a given TMN may be controlled by both the actual interfaces provided and/or by security and routing restrictions provided within the various building block entities (e.g. passwords, log-ons, DCN routing assignment, etc.).

TMN standard interfaces are defined corresponding to the reference points. They are applied at these reference points when external physical connections to them are required.

There is a family of protocol suites for each of the TMN interfaces; Q₃, Q_x, X and F. The choice of the protocol is dependent on the implementation requirements of the physical configuration.

A.2.1 Q interface

The Q interface is applied at q reference points.

To provide flexibility of implementation, the class of Q interfaces is made up of the following subclasses:

- the interface Q₃ is applied at the q₃ reference point;
- the interface Q_x is applied at the q_x reference point.

The Q₃ interface is characterized by that portion of the information model shared between the OS and those TMN elements to which it directly interfaces.

The q_x reference point represents the requirements derived from the interaction between MF-MAF and other applicable

MAFs. The difference in these requirements from those which a q_3 reference point represents will be clarified using TMN management functions (as defined in Recommendation M.3400 [5]) as well as some definite interface characteristics. The difference between Q_x and Q_3 interfaces are for further study. The Q_x interface is characterized by that portion of the information model that is shared between the MD and those NEs and QAs it supports.

The information models for both types of interfaces can potentially be the same but it can normally be expected that the less functionality there is, that the protocol supports, the less generic the information model will be. Hence, the MF is needed to provide conversion between the information models.

Q_x support non standardised protocols.

A.2.2 F interface

The F interface is applied at f reference points. The F interfaces connecting workstations to the TMN building blocks containing OSFs or MFs through a data communication network are included in this Recommendation. Connections of implementation specific, WS-like entities to OSs or NEs, are not subject of this Recommendation.

A.2.3 X interface

The X interface is applied at the x reference point. It will be used to interconnect two TMNs or to interconnect a TMN with other network or systems which accommodates a TMN-like interface. As such, this interface may require increased security over the level which is required by a Q-type interface. It will therefore be necessary that aspects of security are addressed at the time of agreement between associations, e.g. passwords and access capabilities.

The information model at the X interface will set the limits on the access available from outside the TMN. The set of capabilities made available at the X interface for access to the TMN will be referred to as TMN Access.

Additional protocol requirements may be required to introduce the level of security, non-repudiation, etc. which is required.

Relationship of TMN interfaces to TMN building blocks

Table 4 defines the possible interfaces which each named TMN building block can support. It is based upon the function blocks which Table 3 associates with each building block and the reference points between function blocks.

Table 4: Relationship of TMN interfaces to TMN building blocks

	Q_x	Q_3	X	F
NE	(Note 1)			
	O	O	O	O
OS	(Note 1)			
	O	O	O	O
MD	(Note 1)			
	O	O	O	O
QA	(Note 1)			
	O	O		
WS				(Note 2) M
M	Mandatory			
O	Optional			
NOTE 1: At least one of the interfaces inside the box must be present.				
NOTE 2: This mandatory relationship only to workstations.				

Table 5: Differences between TMN interfaces [1]

Differentiating factors	X interface	F interface	Q ₃ interface
Function blocks	OSF- OSF	OSF – WSF MF – WSF	OSF – NEF/ OSF – MF/ OSF – OSF/ OSF – QAF
Service type	interactive (object oriented)/store and forward file transfer/	interactive (object oriented)	interactive (object oriented)/file transfer
Syntax	machine/machine ASN.1	machine/machine human/machine characters	machine/machine ASN.1
Access control requirement on an activity basis	Mandatory	optional	optional
Other security aspects (e.g. data integrity/ encryption)	Yes	yes	For further study
NOTE: Q _x interface is for further study.			

The application layer (layer 7) of each family is common, and is the basis for ensuring interoperability. Some functionality of layer 7 may not always be required (e.g. file transfer). In certain interfaces, some or all of the other layers may have reduced functionality.

The requirement of the lower layers is to support the upper layers. Several network types have been identified as suitable for the transport of TMN messages such as those detailed in Recommendation Q.811 [3]. Any one or a mixture of networks could be used so long as suitable interworking is made available.

For network equipment that does not have an interoperable interface, there is a need to convert the protocols and messages into an interoperable interface format. This conversion is performed by Message Communications Functions plus Q Adaptor Functions which can reside in Q Adaptors, Network Elements, Mediation Devices or Operations Systems.

History

Document history		
0.0.0	19/04/1999	Initial draft
1.0.0	26/04/1999	Draft as submitted to TSG SA Plenary (minor editorial work done to align styles with 3GPP style sheet, but otherwise identical to version 0.0.0)
1.1.0	06/04/1999	Incorporates changes as agreed at TSG SA5 #3 (Helsinki, 4 - 7 May, 1999)
1.1.1	12/5/1999	Reformatting of figure 2 and renumbering of the specification from 32.002 to 32.102 to align with the new 3GPP specification numbering scheme.
1.1.2	14/6/1999	Changes as a result of Cambridge SA5#4 meeting i.e. <ul style="list-style-type: none"> • Section 8.1 Item 2. Text added about recommended protocol for each interface • Section 8.2 Figure 2 redrawn (Interface between NE and OS EM layer changed). • Section 8.3 Compliance conditions has been added. • Section 8.2 – 8.6 All Compliance conditions Item2: “Annex A” added
1.1.3	25/8/1999	Changes as a result of SanDiego SA5#5 meeting i.e. <ul style="list-style-type: none"> • Section 7.2 Last section from “System architecture..” refrased • Section 7.3.1 New text and two figures introduced • Section 7.4 Rewritten • All figures after figure 2 has been reindexed • Section 3.2 New abbreviations introduced
1.2.0	17/9/1999	Changes as a result of Cork SA5#6 meeting i.e. <ul style="list-style-type: none"> • Section 7.4 Last half rewritten • Section 8. All requirements “OSI lower protocol levels...” changed to “Lower protocol levels...” • Section 8.2 Figure 4 redrawn • Editorial changes in section 7.3.2 / 7.4 / Figure 3
1.2.1	12/11/1999	Changes as a result of Tampere SA5#7 meeting i.e. <ul style="list-style-type: none"> • Section 7.2 “IT-business” changed to “business” • Section 7.5 Last sentence deleted • Section 8.2 Clarifying text above Figure 4 • Section 12 and Section 2 New reference [6] added • Spelling errors corrected

1.3.0	10/12/1999	<p>Changes as a result of Bonn SA5#8 meeting i.e.</p> <p>Note: This is the final R99 version which is to be submitted to SA for approval.</p> <ul style="list-style-type: none">• Section 3.1 New definitions added• Section 4.1.1 Changes made in UMTS Reference Model• Section 8.1 – 8.6 Change in Compliance Conditions caused by introduction of the IRP concept• Section 10. New section “Integration Reference Points” inserted• Section 13. Figure 13 editorial changes.
2.0.0	December 1999	Submitted to TSG SA #6 (15 - 17 December 1999) for approval.