

**TSG-RAN Working Group 2 (Radio layer 2 and Radio layer 3)  
Yokohama 13<sup>th</sup> to 16<sup>th</sup> April 1999**

*TSGR2#3(99)202*

**Agenda Item:** 4.2

**Source:** Editor

**Title:** S2.03 : UE Functions and Interlayer Procedures in Connected Mode

**Document for:** Approval

---

# TS RAN S2.03 V0.10.12 (1999-043)

---

*Technical Specification*

**3<sup>rd</sup> Generation Partnership Project (3GPP);  
Technical Specification Group (TSG) RAN;  
Working Group 2 (WG2);**

**UE Functions and Interlayer Procedures  
in Connected Mode**

---

**3GPP**

Reference

---

<Workitem> (<Shortfilename>.PDF)

Keywords

---

<keyword[, keyword]>

**3GPP**

Postal address

---

Office address

---

Internet

---

secretariat@3gpp.org  
Individual copies of this deliverable  
can be downloaded from  
<http://www.3gpp.org>

---

**Copyright Notification**

---

No part may be reproduced except as authorized by written permission.  
The copyright and the foregoing restriction extend to reproduction in all media.

©  
All rights reserved.

# Contents

1. Scope.....	8
2. References.....	8
3. Symbols.....	9
4. General Description of Connected Mode .....	10
5. Description of UE states and state transitions .....	11
5.1 UE RRC States and State Transitions including GSM (PSTN / ISDN only) .....	11
5.2 UE RRC States and State Transitions including GSM / GPRS (IP only).....	13
5.3 Transition from Idle Mode to Connecting State.....	14
5.4 Connecting State .....	14
5.4.1 Transition to Connected Mode.....	15
5.4.2 Transition to Idle Mode .....	15
5.5 Connected Mode States and Transitions .....	15
5.5.1 Cell Connected State.....	15
5.5.1.1 DCH / DCH and DCH / DCH + DSCH substates .....	17
5.5.1.1.1 Control only substate .....	17
5.5.1.1.2 User data active substate.....	17
5.5.1.1.3 Transition from DCH/DCH to DCH/DCH+DSCH substate .....	18
5.5.1.1.4 Transition from DCH/DCH+DSCH to DCH/DCH substate .....	18
5.5.1.1.5 Transition from DCH/DCH to DCH/DSCH+DSCH Ctrl substate.....	18
5.5.1.1.6 Transition from DCH/DSCH+DSCH Ctrl to DCH/DCH substate.....	18
5.5.1.1.7 Transition from DCH/DCH or DCH/DCH+DSCH or DCH / DSCH + DSCH Ctrl to Idle Mode.....	18
5.5.1.1.8 Transition from DCH/DCH or DCH/DCH+DSCH to RACH / FACH substate .....	18
5.5.1.1.9 Transition from DCH/DCH or DCH/DCH+DSCH to RACH+FAUSCH/FACH substate.....	18
5.5.1.1.10 Transition from DCH/DCH or DCH/DCH+DSCH to RACH/DSCH or RACH+FAUSCH/DSCH substates .....	18
5.5.1.1.11 Transition from DCH/DCH or DCH/DCH+DSCH to PCH substate .....	18
5.5.1.1.12 Transition from DCH/DCH or DCH/DCH+DSCH to URA Connected state .....	19
5.5.1.1.13 Radio Resource Allocation tasks (DCH/DCH and DCH/DCH+DSCH).....	19
5.5.1.1.14 RRC Connection mobility tasks (DCH/DCH and DCH/DCH+DSCH) .....	19
5.5.1.1.14.1 Localised Service Area (LSA) support .....	19
5.5.1.2 RACH/FACH and RACH+FAUSCH/FACH substates .....	20
5.5.1.2.1 Transition from RACH/FACH to RACH+FAUSCH/FACH substate.....	20
5.5.1.2.2 Transition from RACH+FAUSCH/FACH to RACH/FACH substate.....	20
5.5.1.2.3 Transition from RACH/FACH to DCH/DCH or DCH/DCH+DSCH substates.....	20
5.5.1.2.4 Transition from RACH+FAUSCH/FACH to DCH/DCH or DCH/DCH+DSCH substates .....	21
5.5.1.2.5 Transition from RACH/FACH or RACH+FAUSCH/FACH to PCH substate.....	21
5.5.1.2.6 Transition from RACH/FACH or RACH+FAUSCH/FACH to Idle Mode.....	21
5.5.1.2.7 Transition from RACH/FACH or RACH+FAUSCH/FACH to RACH / DSCH state .....	21
5.5.1.2.8 Transition from RACH/FACH or RACH+FAUSCH/FACH to URA Connected State .....	21
5.5.1.2.9 Radio Resource Allocation Tasks (RACH/FACH and RACH+FAUSCH/FACH).....	21
5.5.1.2.10 RRC Connection mobility tasks (RACH/FACH and RACH+FAUSCH/FACH).....	22
5.5.1.3 RACH/DSCH and RACH+FAUSCH/DSCH substates .....	22
5.5.1.4 PCH substate.....	22
5.5.1.4.1 Transition from PCH to URA Connected State .....	22
5.5.1.4.2 Transition from PCH to RACH/FACH substate .....	23
5.5.1.4.3 Transition from PCH to RACH+FAUSCH/FACH substate .....	23
5.5.1.4.4 Transition from PCH to RACH/DSCH or RACH+FAUSCH/DSCH substates .....	23
5.5.1.4.5 Radio Resource Allocation Tasks (PCH).....	23
5.5.1.4.6 RRC Connection mobility tasks (PCH).....	23
5.5.2 URA Connected State .....	23
5.5.2.1 Transition from URA Connected State to Cell Connected State.....	24
5.5.2.2 Radio Resource Allocation Tasks (URA Connected) .....	24
5.5.2.3 RRC Connection mobility tasks (URA Connected) .....	25

6. Radio Access Bearer Control – Overview of Procedures .....	26
6.1 Configurable parameters .....	26
6.2 Typical configuration cases .....	26
6.3 RRC Elementary Procedures.....	27
6.3.1 Category 1: Radio Access Bearer Configuration .....	27
6.3.2 Category 2: Transport Channel Configuration .....	27
6.3.3 Category 3: Physical Channel Configuration .....	28
6.3.4 Category 4: Transport Format Combination Restriction .....	28
7. Examples of procedures.....	29
7.1 RRC Connection Establishment and Release Procedures .....	29
7.1.1 RRC connection establishment - Case A.....	29
7.1.2 RRC connection establishment - Case C.....	33
7.1.3 UE Initiated Signalling Connection Establishment .....	36
7.1.4 Normal RRC Connection Release.....	38
7.1.4.1 RRC Connection Release from Dedicated Physical Channel.....	39
7.1.4.2 RRC Connection Release without Dedicated Physical Channel .....	42
7.2 Radio Access Bearer Procedures .....	45
7.2.1 Radio Access Bearer Configuration.....	45
7.2.1.1 Radio Access Bearer Establishment.....	45
7.2.1.1.1 Radio Access Bearer Establishment with Dedicated Physical Channel Activation.....	46
7.2.1.1.2 Radio Access Bearer Establishment with Unsynchronised Dedicated Physical Channel Modification .....	50
7.2.1.1.3 Radio Access Bearer Establishment with Synchronised Dedicated Physical Channel Modification .....	54
7.2.1.1.4 Radio Access Bearer Establishment without Dedicated Physical Channel .....	58
7.2.1.2 Radio Access Bearer Release.....	61
7.2.1.2.1 Radio Access Bearer Release with Unsynchronised Dedicated Physical Channel Modification .....	61
7.2.1.3 Bearer Reconfiguration.....	64
7.2.1.3.1 Unsynchronised Radio Access Bearer And Signalling Link Reconfiguration .....	64
7.2.2 Transport Channel Reconfiguration .....	66
7.2.2.1 Unsynchronised Transport Format Set Reconfiguration .....	67
7.2.3 Physical Channel Reconfiguration .....	69
7.2.3.1 UE-Originated DCH Activation.....	70
7.2.3.2 UE-terminated synchronised DCH Modify .....	74
7.2.3.3 UE-terminated DCH Release .....	77
7.2.4 Transport Format Combination Control.....	80
7.2.4.1 Transport Format Combination Limitation .....	80
7.3 RRC Connection mobility procedures .....	83
7.3.1 Handover Measurement Reporting .....	84
7.3.2 Cell Update .....	86
7.3.3 URA Update .....	90
7.3.4 Radio Link Addition (FDD soft-add).....	93
7.3.5 Radio Link Removal (FDD soft-drop).....	96
7.3.6 Combined radio link addition and removal.....	99
7.3.7 Hard Handover (FDD and TDD hard).....	103
7.3.8 RRC Connection re-establishment .....	107
7.3.9 Inter-system Handover: GSM/BSS to UTRAN .....	111
7.3.10 Inter-System Handover: UTRAN to GSM/BSS, PSTN/ISDN domain services .....	115
7.4 CN originated paging request in connected mode.....	119
7.4.1 UTRAN coordinated paging using DCCH.....	119
7.4.2 UTRAN coordinated paging using PCCH .....	120
7.4.3 UE coordinated paging .....	120
7.5 UTRAN originated paging request and paging response .....	121
7.6 Other procedures.....	123
7.6.1 UE Capability Information.....	123
8. Traffic volume monitoring.....	124
9. History .....	124

---

# Intellectual Property Rights

[Editor's note: This paragraph has been modified from corresponding ETSI text in anticipation of a new version regarding 3GPP.]

IPRs essential or potentially essential to the present deliverable may have been declared to 3GPP. The information pertaining to these essential IPRs, if any, is publicly available for **3GPP members and non-members, free of charge**. This can be found in the latest version of the 3GPP Technical Report: ETR 314: "Intellectual Property Rights (IPRs); Essential or potentially Essential, IPRs notified to 3GPP in respect of 3GPP standards". The most recent update of ETR 314, is available on the 3GPP web server or on request from the Secretariat.

Pursuant to the 3GPP Interim IPR Policy, no investigation, including IPR searches, has been carried out by 3GPP. No guarantee can be given as to the existence of other IPRs not referenced in the ETR 314, which are, or may be, or may become, essential to the present document.

---

## Foreword

This Technical Specification has been produced by the 3<sup>rd</sup> Generation Partnership Project, Technical Specification Group RAN, working group 2.

The contents of this TS may be subject to continuing work within the 3GPP and may change following TSG RAN WG2 approval. Should the TSG RAN WG2 modify the contents of this TS, it will be re-released with an identifying change of release date and an increase in version number as follows:

Version m.t.e

where:

- m indicates [major version number]
- x the second digit is incremented for all changes of substance, i.e. technical enhancements, corrections, updates, etc.
- y the third digit is incremented when editorial only changes have been incorporated into the specification.

---

## Scope

This document defines the UE States and the principal tasks undertaken by the UE when in Connected Mode. It includes informative interlayer procedures for the UE to perform the required tasks.

This document attempts to provide a comprehensive overview of the different states and transitions within the connected mode of a UMTS terminal. The applicable set of states for a given service may be a subset of the total set of possible states.

In addition to describing the states and related transitions, this document describes all procedures that assign, reconfigure and release radio resources. Included are e.g. procedures for transitions between different states and substates, handovers and measurement reports. The emphasis is on showing the combined usage of both peer-to-peer messages and interlayer primitives to illustrate the functional split between the layers, as well as the combination of elementary procedures for selected examples. The peer-to-peer elementary procedure descriptions are described in the related protocol descriptions /1, 2, 3/ and they are thus not within the scope of this document.

---

## References

The following documents contain provisions which, through reference in this text, constitute provisions of the present document.

- References are either specific (identified by date of publication, edition number, version number, etc.) or non-specific.
- For a specific reference, subsequent revisions do not apply.
- For a non-specific reference, the latest version applies.
- A non-specific reference to an ETS shall also be taken to refer to later versions published as an EN with the same number.

[<seq>]            <doctype> <#>[ ([up to and including]{yyyy[-mm]}V<a[.b[.c]]>){onwards}]: "<Title>".

[1]                S2.21, "MAC Protocol Specification"

[2]                S2.22, "RLC Protocol Specification"

[3]                S2.31, "RRC Protocol Specification"

[4]                S2.04, "UE Procedures in Idle Mode"

[5]                S2.01, "Radio Interface Protocol Architecture"



## Symbols

For the purposes of the present document, the following symbols apply:

- + A “+” in a substate name means that transport channels separated by the symbol can both be used in that substate. The name doesn’t define whether simultaneous multicode transmission is allowed on these channels. E.g. in DCH / DCH + DSCH both downlink transport channels can be actively transmitting at the same time, but in RACH + FAUSCH / FACH simultaneous transmission on RACH and FAUSCH requiring multicode transmission should not be necessary.

---

## General Description of Connected Mode

The connected mode is entered when the RRC connection is established. The UE is assigned a radio network temporary identity (RNTI) to be used as UE identity on common transport channels. Two types of RNTI exist. The Serving RNC allocates an s-RNTI for all UEs having an RRC connection. The combination of s-RNTI and an RNC-ID is unique within a PLMN. c-RNTI is allocated by each Controlling RNC through which UE is able to communicate on DCCH. c-RNTI is always allocated by UTRAN when a new UE context is created to an RNC, but the UE needs its c-RNTI only for communicating on common transport channels.

The UE leaves the connected mode and returns to idle mode when the RRC connection is released or at RRC connection failure.

Within connected mode the level of UE connection to UTRAN is determined by the quality of service requirements of the active radio access bearers and the characteristics of the traffic on those bearers.

The UE-UTRAN interface is designed to support a large number of UE:s using packet data services by providing flexible means to utilize statistical multiplexing. Due to limitations, such as air interface capacity, UE power consumption and network h/w availability, the dedicated resources cannot be allocated to all of the packet service users at all times.

The UE state in the connected mode defines the level of activity associated to the UE. The key parameters of each state are the required activity and resources within the state and the required signalling prior to the data transmission. The state of the UE shall at least be dependent on the application requirement and the period of inactivity.

Packet Services can be supported also using the FAUSCH, by means of which a dedicated transport channel can be allocated for data transmission.

*[Editor's note: The FAUSCH transport channel is still under discussion in the L1 Expert Group. If the corresponding physical channel is not approved, then the FAUSCH Transport Channel will be removed]*

The different levels of UE connection to UTRAN are listed below:

- No signalling connection exists  
The UE is in idle mode and has no relation to UTRAN, only to CN. For data transfer, a signalling connection has to be established.
- Signalling connection exists  
When at least one signalling connection exists, the UE is in connected mode and there is normally an RRC connection between UE and UTRAN. The UE position can be known on different levels:

- UTRAN Registration Area (URA) level  
The UE position is known on URA level. The URA is a set of cells
  
- Cell level  
The UE position is known on cell level. Different transport channel types can be used for data transfer:
  - Common transport channels (RACH/FACH)
  - Dedicated transport channels (DCH) (FAUSCH can be used to allocate a dedicated transport channel for data transmission.)

Assuming that there exists an RRC connection, there are two basic families of RRC connection mobility procedures, URA updating and handover. Different families of RRC connection mobility procedures are used in different levels of UE connection (cell level and URA level):

- URA updating is a family of procedures that updates the UTRAN registration area of a UE when an RRC connection exists and the position of the UE is known on URA level in the UTRAN.
- Handover is a family of procedures that adds or removes one or several radio links between one UE and UTRAN when an RRC connection exists and the position of the UE is known on cell level in the UTRAN.

---

## Description of UE states and state transitions

The proposed state diagram has been based on a few key assumptions. The set of states shall be comprehensive enough in order to satisfy the range of QoS requirements from very fast packet access to optimum saving of the resources (Node B h/w, UE power, air interface capacity). A comprehensive set of states between the two extremes is required for optimization purposes.

### UE RRC States and State Transitions including GSM (PSTN / ISDN only)

Figure 1 shows the main UE RRC states (Cell Connected State and URA Connected State) in Connected Mode. It also shows the transitions between Idle Mode and Connected Mode and further the transitions between Cell Connected and URA Connected States. ~~The different states and transitions are further clarified in following subsections.~~

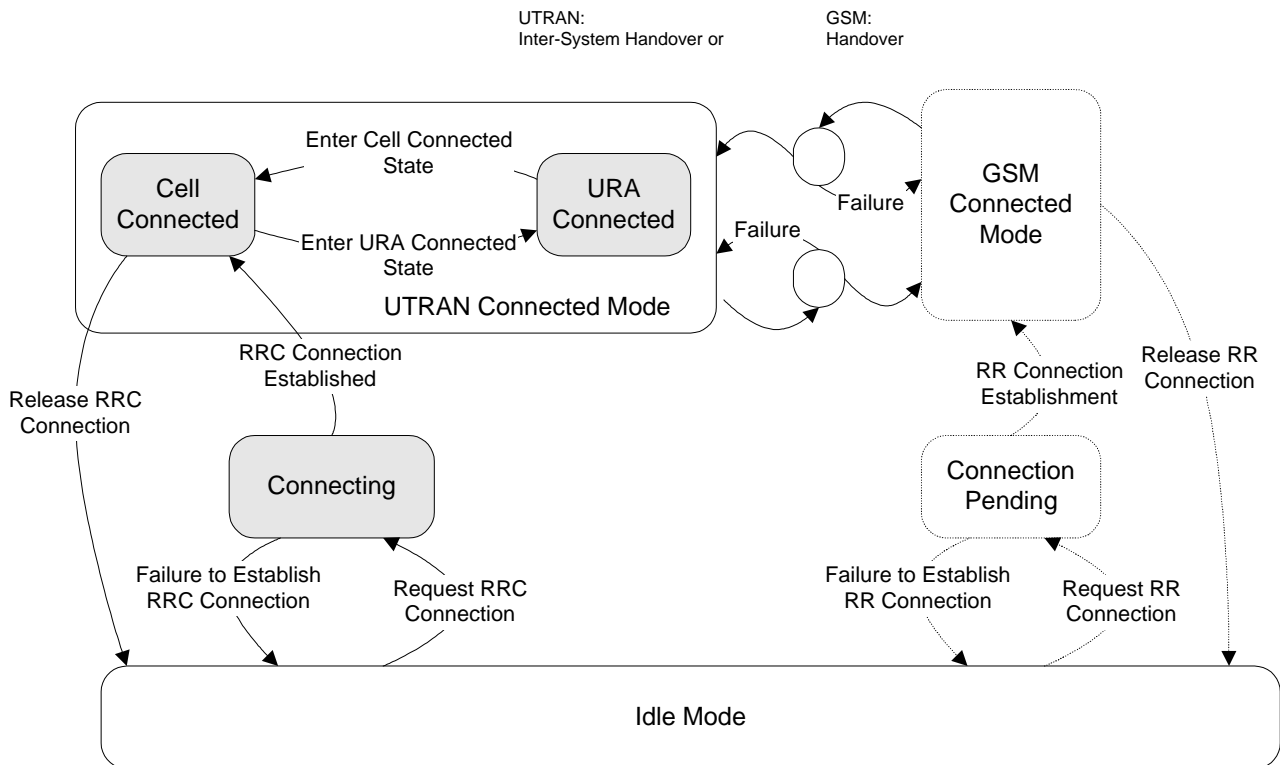

**Figure 1: UE RRC States and State Transitions including GSM (PSTN/ISDN only)**

It shall be noted that not all states may be applicable for all UE connections. For a given QoS requirement on the UE connection, only a subset of the states may be relevant.

After power on, the UE stays in Idle Mode until it transmits a request to establish an RRC Connection. In Idle Mode the connection of the UE is closed on all layers of the UTRAN. In Idle Mode the UE is identified by non-access stratum identities such as IMSI, TMSI and P-TMSI. In addition, the UTRAN has no own information about the individual Idle Mode UE:s, and it can only address e.g. all UE:s in a cell or all UE:s in a paging group. The UE behaviour within this mode is described in /4/.

~~[Editor's note: As "equipment" has no plural form in English, change proposals for the previous section are invited.]~~

The Connected Mode is entered when the RRC Connection is established. This is done via the Connecting State. The UE is assigned a radio network temporary identity (RNTI) to be used as UE identity on common transport channels. *[Note: The exact definition of RRC connection needs further refinement.]* The main RRC states within Connected Mode reflect the level of UE connection.

For inactive stationary data users the UE may fall back to PCH in both Cell Connected and URA Connected States. That is, upon the need for paging, the UTRAN shall check the current level of connection of the given UE, and decide whether the paging message shall be sent within the URA, or should it be sent via a specific cell.

The UE states indicated between UTRAN Connected Mode and GSM Connected Mode are transition states where the UE, in case of failure, has the possibility to re-establish the connection in the mode it originated from.

When using PSTN / ISDN domain services, UTRAN is using an Inter-System Handover Procedure and GSM is using a Handover procedure for the transition from UTRAN Connected Mode to GSM Connected Mode. ~~Behaviour with IP domain services is FFS.~~

## UE RRC States and State Transitions including GSM / GPRS (IP only)

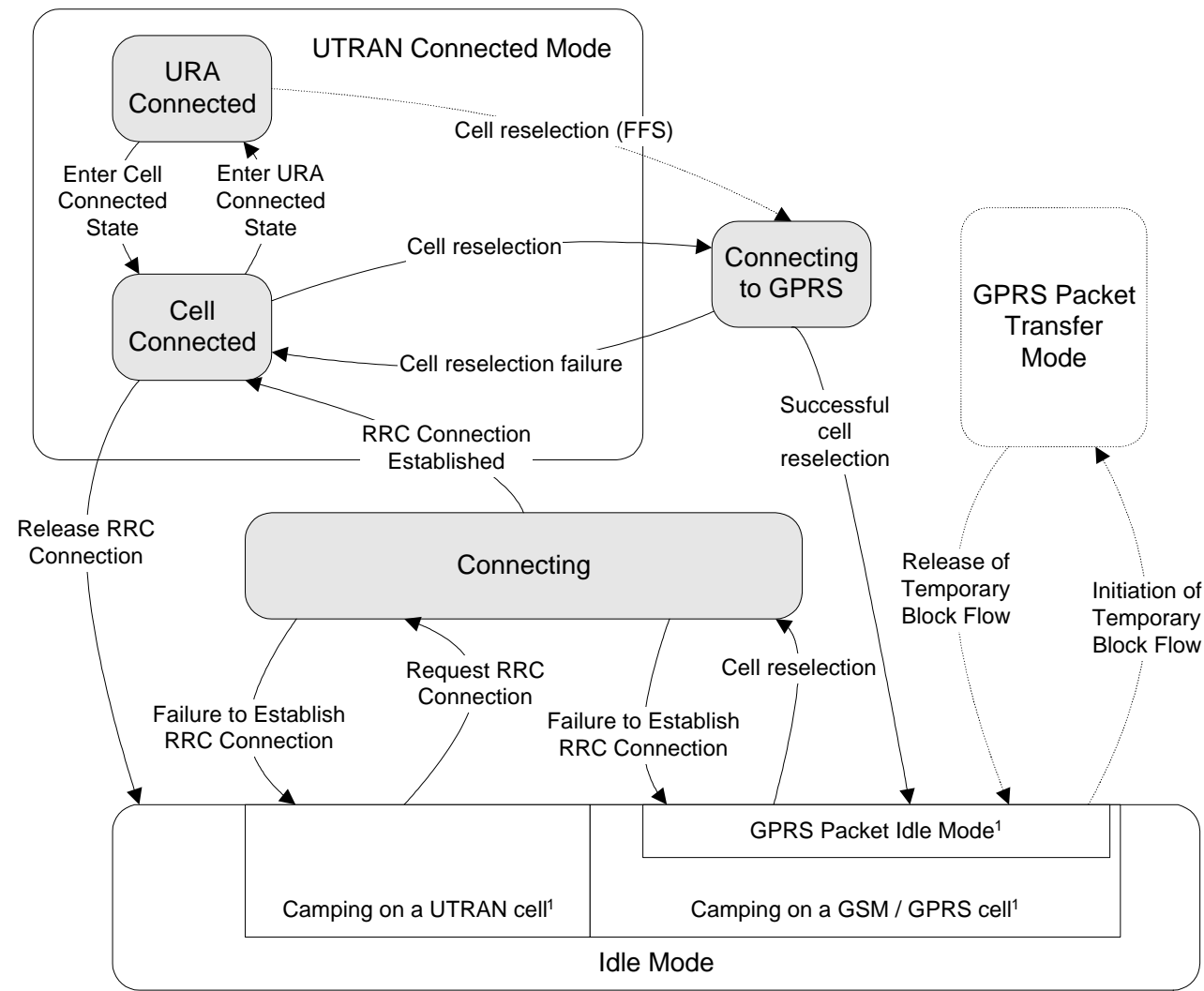

Figure 2: UE RRC states and State Transitions including GSM/GPRS (IP only)

**[<sup>1</sup>: The indicated “Radio access modes” in Idle Mode are only included for clarification and shall not be interpreted as states.]**

The UE states “Connecting to GPRS” and “Connecting” indicated in figure 2 between UTRAN Connected Mode and Idle mode (GPRS Packet Idle Mode) are transition states where the UE, in case of failure, has the possibility to re-establish the connection in the mode it originated from.

When using IP domain services, The UE initiates cell reselection from GSM/GPRS to change from Idle Mode to “Connecting” state, from that state the UE is using the RRC Connection Establishment procedure for the transition from “Connecting” to Cell Connected state.

When the RRC Connection is established from Idle Mode (GPRS Packet Idle Mode) the RRC Connection request message contains an indication, that UTRAN needs to continue an already established GPRS UE context from the CN. This indication allows UTRAN to e.g. prioritize the RRC Connection request from the UE.

In Cell Connected or URA Connected (FFS) State UTRAN is using UE or Network initiated cell reselection to change from Cell Connected or URA Connected (FFS) state to "Connecting to GPRS" state. If the cell reselection was successful the UE enters Idle Mode (GPRS Packet Idle Mode). The UE sends a packet channel request from Idle Mode (GPRS Packet Idle mode) to establish a Temporary Block flow and enter GPRS Packet Transfer Mode. In the GPRS Packet Transfer Mode the UE sends a RA Update request message. The RA Update Request message sent from the UE contains an indication that GSM/GPRS need to continue an already established UTRAN UE context from the CN. This means that the RA Update request is always sent for the transition from UTRAN Connected Mode to GSM/GPRS regardless if the RA is changed or not.

[Note: The reason for using RA update instead of a new message is to reduce the impact on the existing GSM/GPRS specification.]

## Transition from Idle Mode to Connecting State

The transition to the Connecting State from the Idle Mode can only be initiated by the UE by transmitting a request for an RRC Connection. The event is triggered either by a paging request from the network or by a request from upper layers in the UE.

## Connecting State

In the Connecting State (Figure 3) the UE has transmitted a request for an RRC connection and it waits for a response. No mobility procedures take place in this state.

In this state, the UE transmits on RACH transport channel in the uplink and receives the FACH transport channel in the downlink. Only the logical channel CCCH can be used, since no RNTI is assigned. Connecting state is shown in Figure 3.

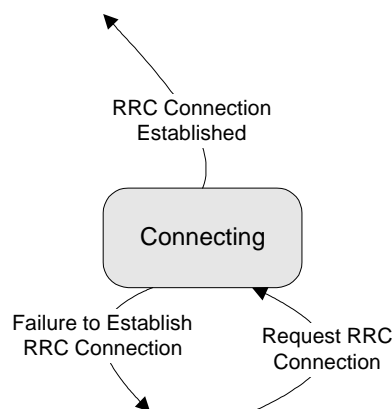

**Figure 3: Connecting State**

## Transition to Connected Mode

When the UE receives a message from the network that confirms the RRC connection establishment, the UE enters the cell connected state.

## Transition to Idle Mode

In the case of a failure to establish the RRC Connection the UE goes back to Idle Mode. Possible causes are radio link failure, a received reject response from the network or lack of response from the network (timeout).

## Connected Mode States and Transitions

### Cell Connected State

In this state, the position of the UE is known on cell level. The RRC Connection mobility is handled by handover procedures including soft handover, hard handover and cell updates. Both uplink and downlink data transfer is possible.

*[Editor's note: The FAUSCH transport channel is still under discussion in the L1 Expert Group. If the corresponding physical channel is not approved, then the FAUSCH Transport Channel will be removed]*

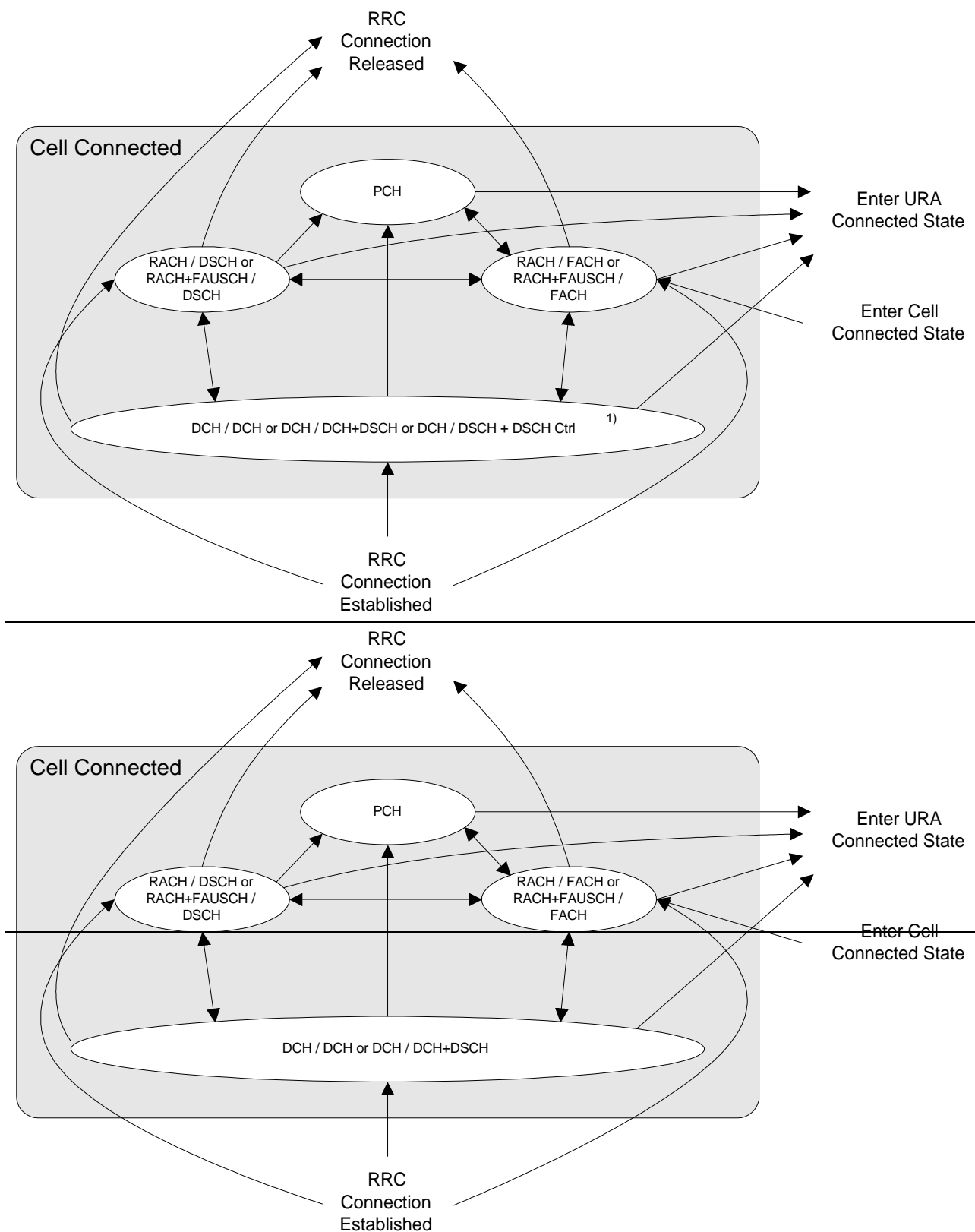

Figure 4: Substates within Cell Connected State

[<sup>1)</sup>: Inclusion of the DCH / DSCH + DSCH Ctrl substate is based on the assumption that DSCH Ctrl contains power control bits. If these PC bits don't exist, this substate is not needed.]



## DCH / DCH and DCH / DCH + DSCH substates

These substates are characterized by the allocation of a dedicated transport channel to the UE. The DCH-states are entered from the Connecting State through the setup of an RRC connection, or by establishing a dedicated channel (DCH) from the RACH / FACH, RACH + FAUSCH / FACH, RACH + FAUSCH / DSCH or RACH / DSCH substates.

These substates are further divided depending on the type of information that is allowed to be transmitted on the dedicated channel(s) and the downlink shared channel. The substates are shown in Figure 5.

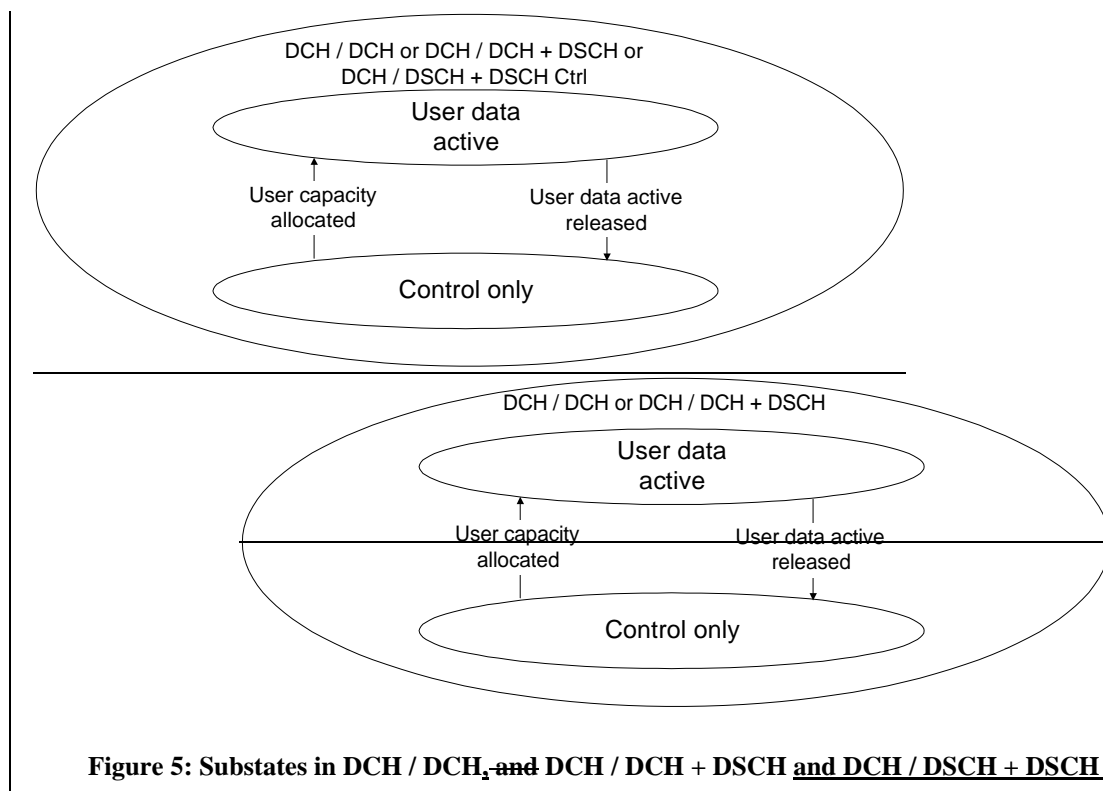

**Figure 5: Substates in DCH / DCH, and DCH / DCH + DSCH and DCH / DSCH + DSCH Ctrl substates**

### Control only substate

[Editor's note: The applicability of the control only substate to the TDD-mode is FFS. ]

In Control only substate, the uplink and downlink DCHs are allocated, but no user data frames can be exchanged with the exception of data that uses the signalling connection e.g. SMS. Signalling in this substate includes link maintenance and higher layer signalling.

The Control only substate is provided to save air interface capacity and provide efficient packet transfer capacity allocation.

### User data active substate

In this substate UTRAN has allocated transmission resources for the UE and it may transmit data without a prior request up to the peak capacity that is currently granted to that UE.

In DCH/DCH+DSCH state some part or all of the DTCH resources can be allocated from the DSCH.

Transition from DCH/DCH to DCH/DCH+DSCH substate

FFS.

Transition from DCH/DCH+DSCH to DCH/DCH substate

FFS.

Transition from DCH/DCH to DCH/DSCH+DSCH Ctrl substate

FFS.

Transition from DCH/DSCH+DSCH Ctrl to DCH/DCH substate

FFS.

Transition from DCH/DCH or DCH/DCH+DSCH or DCH / DSCH + DSCH Ctrl to Idle Mode

Transition to Idle Mode is realised through the release of the RRC connection.

Transition from DCH/DCH or DCH/DCH+DSCH to RACH / FACH substate

Transition to RACH/FACH substate can occur either

- a) through the expiration of an inactivity timer ( $T_{DCH}$ ),
- b) at the end of the time period for which the dedicated / shared channel was allocated or
- c) via explicit signalling.

Transition from DCH/DCH or DCH/DCH+DSCH to RACH+FAUSCH/FACH substate

Similar to 0, differences FFS.

Transition from DCH/DCH or DCH/DCH+DSCH to RACH/DSCH or RACH+FAUSCH/DSCH  
substates

FFS.

Transition from DCH/DCH or DCH/DCH+DSCH to PCH substate

FFS.

Transition from DCH/DCH or DCH/DCH+DSCH to URA Connected state

FFS.

### Radio Resource Allocation tasks (DCH/DCH and DCH/DCH+DSCH)

For the DCH, several physical channel allocation strategies may be applied. The allocations can be either permanent (needing a DCH release message) or based on time or amount-of-data.

Resource allocation can be done separately for each packet burst with fast signalling on the DCH. Transition out of the Control only state is either triggered by user capacity allocation or by timeout (no data transaction requests received within a specified time period).

For each radio frame the UE and the network indicate the current data rate (in uplink and downlink respectively) using the transport format combination indicator (TFCI). If the configured set of combinations (i.e. transport format set for one transport channel) are found to be insufficient to retain the QoS requirements for a transport channel, the network initiates a reconfiguration of the transport format set (TFS) for that transport channel. This reconfiguration can be done during or in between data transmission. Further, the network can reconfigure the physical channel allowing an increase or decrease of the peak data rate.

For the uplink data transmission, the UE reports the observed traffic volume to the network in order for the network to re-evaluate the current allocation of resources. This report contains e.g. the amount of data to be transmitted or the buffer status in the UE.

If during data transfer the UE is unable to transmit at the requested output power when using the peak allocated capacity, the UE shall reduce transmission rate within the current 10 ms radio frame in order to maintain the closed-loop power control.

### RRC Connection mobility tasks (DCH/DCH and DCH/DCH+DSCH)

Depending on the amount and frequency of data macrodiversity (soft handover) may or may not be applied.

The RRC Connection mobility is handled by measurement reporting, soft handover and hard handover procedures.

### Localised Service Area (LSA) support

*[Editor's note: A liaison statement to SMG12 has been sent to receive guidance on the functionalities that would need to be defined in UTRAN to support SoLSA-like (Support of LSA, GSM) services.]*

In case of a network-controlled handover procedure, UTRAN shall take into account the local support of LSA service and the eventual subscription information of the UE to those LSA regarding the provision of service to the UE.

Regarding soft handover, the following principles are applied by UTRAN:

- For "LSA only" UE, the RRC connection shall be maintained by UTRAN as long as at least one cell of the active set belongs to a UE subscribed LSA.
- For "LSA exclusive access" cells, UTRAN shall prevent such cell from being part of the active set if the UE has not subscribed to the corresponding LSA

Regarding network controlled hard handover, the following principles are applied by UTRAN:

- For "LSA only" UE, UTRAN shall prevent the UE from being handed over a cell which does not belong to a UE subscribed LSA.
- For "LSA exclusive access" cells, UTRAN shall prevent the UE from being handed over such a cell if the UE has not subscribed to the corresponding LSA

## RACH/FACH and RACH+FAUSCH/FACH substates

The position of the UE is known by UTRAN on cell level. In the RACH / FACH substate the UE performs the following actions:

- listens to ~~will monitor~~ an FACH
- listens to the BCH transport channel of the serving cell for the decoding of system information messages (FFS)
- initiates a cell update procedure on cell change
- ~~It is enabled to transmit~~ transmits uplink control signals and ~~may be able to transmit~~ small data packets on the RACH.

[Editor's note: The FFS on the decoding of BCH was requested by the editor and is now proposed to be removed.]

Furthermore, the UE can use the FAUSCH to trigger the allocation of a new DCH by RNC. Further rate adaptation can be done via the DCCH of the new DCH. ~~For the UE to be able to monitor a single FACH the cell in which the UE is located is known to the UTRAN.~~

### Transition from RACH/FACH to RACH+FAUSCH/FACH substate

FFS.

### Transition from RACH+FAUSCH/FACH to RACH/FACH substate

FFS.

### Transition from RACH/FACH to DCH/DCH or DCH/DCH+DSCH substates

A transition occurs, when a dedicated transport channel is established via explicit signalling. Examples of these procedures are given in section 0.

Details of the transition to DCH/DCH+DSCH FFS.

#### Transition from RACH+FAUSCH/FACH to DCH/DCH or DCH/DCH+DSCH substates

The state transition is done by using the FAUSCH.

#### Transition from RACH/FACH or RACH+FAUSCH/FACH to PCH substate

Since the UE performs continuous reception of FACH in this substate, it should be moved to the PCH substate if the data service has not been active for a while. When an inactivity timer ( $T_{rf}$ ) expires, the UE state is changed to PCH in order to decrease power consumption. Also, when coming from PCH substate, and after the cell update procedure has been performed, the UE state is changed back to PCH substate if neither the UE nor the network has any data to transmit.

When coming from the RACH+FAUSCH/FACH substate, the FAUSCH is still available in the PCH substate after the transition.

#### Transition from RACH/FACH or RACH+FAUSCH/FACH to Idle Mode

The release of the RRC connection moves the UE to the idle mode.

#### Transition from RACH/FACH or RACH+FAUSCH/FACH to RACH / DSCH state

FFS.

#### Transition from RACH/FACH or RACH+FAUSCH/FACH to URA Connected State

To perform the URA update procedure, UE is moved temporarily from URA Connected to RACH / FACH or RACH + FAUSCH / FACH substate. After the URA update is completed, UE state is changed back to URA Connected.

If FAUSCH is intended to be used in URA Connected State, a FAUSCH transport channel needs to be allocated for the intended cells in the URA prior to this transition.

#### Radio Resource Allocation Tasks (RACH/FACH and RACH+FAUSCH/FACH)

In the RACH / FACH substate the UE will monitor an FACH. It is enabled to transmit uplink control signals and it may be able to transmit small data packets on the RACH. The network can assign the UE transport channel parameters (e.g. transport format sets) in advance, to be used when a DCH is used. When the physical channel for DCH is assigned, the transport channel type is switched to DCH and the assigned TFS can be used.

When there is either user or control data to transmit, a selection procedure determines whether the data should be transmitted on a common transport channel, or if a dedicated transport channel should be allocated. The selection should be dynamic and depend on traffic parameters (amount of data, packet burst frequency).

## RRC Connection mobility tasks (RACH/FACH and RACH+FAUSCH/FACH)

In this substate the location of the UE is known on cell level. A cell update procedure is used to report to the UTRAN, when the UE selects a new cell to observe the common downlink channels of a new Node B. In this substate measurement reporting and hard handover procedures can be used. Downlink data transmission on the FACH can be started without prior paging.

In RACH / FACH substate an RACH / FACH cell set comparable to the active set of a dedicated channel in SHO is maintained both in the UE and in the network. The RACH / FACH cell set represents a list of cells which have the potential to serve the UE from radio signal strength perspective. The UE performs measurements and reporting for the RACH / FACH cell set using the same procedures as in DCH/DCH+DSCH substates. The thresholds required for triggering a measurement report may be different from those in DCH-based substates.

The RACH/FACH cell set information is used by the network to decide whether the user data can be routed directly via a cell to a specific UE or soft handover would be required when resuming the DCH operation. In addition, the RACH/FACH cell set information provides the means for the network to evaluate potential interference conditions and select a suitable amount of capacity when moving the UE in the DCH active substate, for both uplink and downlink data transfer.

The UE monitors the broadcast channel and system information on BCCH of its own and neighbour cells and from this the need for the updating of cell location is identified.

## RACH/DSCH and RACH+FAUSCH/DSCH substates

FFS.

## PCH substate

The position of the UE is known by UTRAN on cell level. In this substate the UE performs the following actions:

- -listens to the PCH transport channel for the decoding of paging and notification messages sent by the network-
- listens to the BCH transport channel of the serving cell for the decoding of system information messages
- initiates a cell update procedure on cell change.

-The DCCH logical channel cannot be used in this substate. If the network wants to initiate any activity, it needs to make a paging request on the PCCH logical channel in the known cell to initiate any downlink activity. ~~The UE initiates a cell update procedure when it selects a new cell.~~

## Transition from PCH to URA Connected State

The only overhead in keeping a UE in the PCH substate is the potential possibility of cell updating, when the UE moves to other cells.

To reduce this overhead, the UE is moved to the URA Connected State when low activity is observed. This can be controlled with an inactivity timer, and optionally, with a counter which counts the number of cell updates. When the number of cell updates has exceeded certain limits (a network parameter), then the UE changes to the URA Connected State.

*[Editor's note: If the coverage area of FAUSCH is expanded from one cell to several cells in the URA in relation to the execution of this transition, the new FAUSCH allocation information for each new cell in the URA needs to be exchanged either in RACH+FAUSCH/FACH or a DCH-based substate prior to a transition from PCH to URA connected state. For proper operation, this shouldn't be observed as increased activity.]*

### Transition from PCH to RACH/FACH substate

The UE is transferred to RACH/FACH substate either by a command (packet paging) from UTRAN or through any uplink access.

### Transition from PCH to RACH+FAUSCH/FACH substate

If a valid FAUSCH transport channel is allocated for the current cell, the UE changes to RACH+FAUSCH/FACH substate as soon as it uses the FAUSCH to allocate a DCH.

### Transition from PCH to RACH/DSCH or RACH+FAUSCH/DSCH substates

FFS.

### Radio Resource Allocation Tasks (PCH)

In PCH substate no resources have been granted for data transmission. For this purpose, a transition to another substate has to be executed.

### RRC Connection mobility tasks (PCH)

In the PCH substate, the UE mobility is performed through cell reselection procedures, which may differ from the one defined in S2.04.

Cell updating is initiated by the UE which, upon the detection of the new cell, moves to RACH/FACH substate and initiates a cell update procedure in the new cell. After the cell update procedure has been performed, the UE state is changed back to PCH substate if neither the UE nor the network has any more data to transmit.

## URA Connected State

In URA Connected State (Figure 6) the location of a UE is known on UTRAN Registration area level. ~~The URA contains a set of cells. The mobility in this state is handled by URA updating procedures.~~

In this substate the UE performs the following actions:

- listens to the PCH transport channel for the decoding of paging and notification messages sent by the network
- listens to the BCH transport channel of the serving cell for the decoding of system information messages
- initiates a URA updating procedure on URA change.

The DCCH logical channel cannot be used in this substate. If the network wants to initiate any activity, it needs to make a paging request on the PCCH logical channel within the URA where the location of the UE is known. If the UE needs to transmit anything to the network, it goes to the RACH/FACH substate of the Cell Connected State. In addition, the UE can also use the FAUSCH for requesting a DCH in the whole URA or parts of it, if the UE has been allocated - on entering the connected mode or via explicit signalling later on - a FAUSCH channel for the cell, which the UE is currently camping on.

The transition to URA Connected State can be controlled with an inactivity timer, and optionally, with a counter which counts the number of cell updates. When the number of cell updates has exceeded certain limits (a network parameter), then the UE changes to the URA Connected State.

URA updating is initiated by the UE which, upon the detection of the Registration area, sends the network the Registration area update information on the RACH of the new cell.

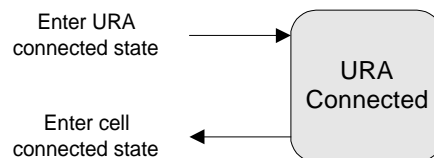

**Figure 6: URA Connected State**

### Transition from URA Connected State to Cell Connected State

Any activity causes the UE to be transferred to RACH / FACH or RACH + FAUSCH / FACH substate of the Cell Connected State. Uplink access is performed by either RACH or FAUSCH, if a FAUSCH transport channel for the current cell has been allocated.

Note that the release of an RRC connection is not possible in the URA Connected State. The UE will first move to Cell Connected State to perform the release signalling.

### Radio Resource Allocation Tasks (URA Connected)

In URA Connected State no resources have been granted for data transmission. For this purpose, a transition to a suitable substate of Cell Connected State has to be executed.



## RRC Connection mobility tasks (URA Connected)

In URA Connected State the location of a UE is known on UTRAN Registration area level. ~~The URA contains a set of cells. The mobility in this state is handled by URA updating procedures.~~

In this state, the UE mobility is performed through URA reselection procedures, which may differ from the definitions in S2.04. If the new cell belongs to a different URA, the UE~~URA updating is initiated by the UE which, upon the detection of the new URA,~~ moves to RACH/FACH substate of the cell connected state and initiates a URA update towards the network. After the URA update procedure has been performed, the UE state is changed back to URA connected state if neither the UE nor the network has any more data to transmit.

# Radio Access Bearer Control – Overview of Procedures

## Configurable parameters

The following layer 1, MAC and RLC parameters should be able to configure by RRC. The list is not complete.

- Radio access bearer parameters, e.g.
  - RLC parameters per RLC link (radio access bearer), which may include e.g. PDU size and timeout values. Used by RLC.
  - Multiplexing priority per DCCH/DTCH. Used by MAC in case of MAC multiplexing of logical channels.
- Transport channel parameters, e.g.
  - Scheduling priority per transport channel. Used by MAC in case of layer 1 multiplexing of transport channels.
  - Transport format set (TFS) per transport channel. Used by MAC and L1.
  - Transport format combination set (TFCS) per UE. Used by MAC and L1.
  - Allowed subset of TFCS per UE. Used by MAC.
- Physical channel parameters, which may include e.g. carrier frequency and codes. Used by L1.

## Typical configuration cases

The table below gives a proposal which main combination cases of parameter configuration that shall be supported, in terms of which parameters that shall be able to configure simultaneously (by one procedure). Note that the “Transport channel type switching” is not a parameter as such, it only indicates that switching of transport channel type may take place for that combination case.

Parameter		Layer	A	B	C	D	E
Radio access bearer parameters	RLC parameters	RLC	X				
	Logical channel multiplexing priority	MAC	X				
Transport channel parameters	Transport channel scheduling priority	MAC	X				
	TFS	L1+MAC	X	X			
	TFCS	L1+MAC	X	X			
	Subset of TFCS	MAC					X
	Transport channel type switching	MAC	X	X	X		
Physical channel parameters		L1	X	X	X	X	

**Table 1. Typical configuration cases. An “X” indicates that the parameter can (but need not) be configured.**

Case A is typically when a radio access bearer is established or released, or when the QoS of an existing radio access bearer or the signalling link need to be changed (the necessity of change of QoS is FFS).

Case B is when the traffic volume of a radio access bearer has changed so the TFS used on the DCH need to be changed, which may in turn affect any assigned set of physical channels. Another example is to make the UE use a new transport channel and at the same time supplying the TFS for that channel.

Case C is when the traffic volume of one radio access bearer has changed so that the used transport channel type is changed from e.g. RACH/FACH to DCH/DCH, which includes the assignment or release of a set of physical channels.

Case D is e.g. the change of used DL channelization code, when a DCH is currently used. No transport channel type switching take place.

Case E is a temporary restriction and/or a release of restriction for usage of the TFCS by the UE (total uplink rate).

## RRC Elementary Procedures

### Category 1: Radio Access Bearer Configuration

The first category of procedures includes Case A and are characterized by:

- Are executed upon request by higher layers and the parameter configuration is based on QoS
- Affects L1, MAC and RLC.

There are three RRC procedures included in this category:

- **Radio Access Bearer Establishment.** This procedure establishes a new radio access bearer. The establishment includes, based on QoS, assignment of RLC parameters, multiplexing priority for the DTCH, scheduling priority for DCH, TFS for DCH and update of TFCS. It may also include assignment of a physical channel(s) and change of the used transport channel types / RRC state.
- **Radio Access Bearer Release.** This procedure releases a radio access bearer. The RLC entity for the radio access bearer is released. The procedure may also release a DCH, which affects the TFCS. It may include release of physical channel(s) and change of the used transport channel types / RRC state.
- **Bearer Reconfiguration.** This procedure reconfigures parameters for a radio access bearer or the signalling link to reflect a change in QoS. It may include change of RLC parameters, change of multiplexing priority for DTCH/DCCH, change of DCH scheduling priority, change of TFS for DCH, change of TFCS, assignment or release of physical channel(s) and change of used transport channel types. *[Note: The necessity of this procedure is FFS.]*

### Category 2: Transport Channel Configuration

The second category of procedures includes Case B and are characterized by:

- Configuration of TFS for a transport channel and reconfiguration of TFCS is done, but sometimes also physical channel parameters.
- Affects L1 and MAC.
- Switching of used transport channel(s) may take place.

There is one RRC procedure included in this category:

- **Transport Channel Reconfiguration.** This procedure reconfigures parameters related to a transport channel such as the TFS. The procedure also assigns a TFCS and may change physical channel parameters to reflect a

reconfiguration of a transport channel in use. *[Note: It is expected that the configuration of TFS/TFCS needs to be done more seldom than the assignment of physical channel. A “pre-configuration” of TFS/TFCS of a transport channel not in use can be done by this procedure, to be used after transport channel type switching when the physical channel is assigned.]*

### Category 3: Physical Channel Configuration

The third category of procedures includes the cases C and D and are characterized by:

- May assign or release a physical channel for the UE (which may result in transport channel type switching)
- May make a combined release and assignment (replacement) of a physical channel in use (which does not result in transport channel type switching / change of RRC state).
- Affects mainly L1, and only the transport channel type switching part of MAC.
- The transport format sets (TFS and TFCS) are not assigned by this type of procedure. However, the UE can be directed to a transport channel, which TFS is already assigned to the UE.

There is one RRC procedure included in this category:

- **Physical Channel Reconfiguration.** This procedure may assign, replace or release a set of physical channels used by an UE. As a result of this, it may also change the used transport channel type (RRC state). For example, when the first physical channel is assigned the UE enters the DCH/DCH state. When the last physical channel is released the UE leaves the DCH/DCH state and enters a state (and transport channel type) indicated by the network. A special case of using this procedure is to change the DL channelization code of a dedicated physical channel. *[Note: The procedure does not change the active set, in the downlink the same number of physical channels are added or replaced for each radio link.]*

### Category 4: Transport Format Combination Restriction

The fourth category of procedures includes Case E and are characterized by:

- Does only control MAC by means of the transport format combinations that may be used within the set without affecting L1.

There is one RRC procedure included in this category:

- **Transport format combination control.** The network uses this procedure towards an UE, to control the used transport format combinations in the uplink within the transport format combination set.

## Examples of procedures

[Editor's Note: All primitive names have been changed since the previous version, please notify any inconsistencies found. The use of TrCH-Config and TrCH-Release primitives, which were introduced in the previous WG2 meeting, has not been discussed and should be viewed as a proposal from the editor, until approved.]

These sequences are examples and do not provide a comprehensive set of all different scenarios.

In cases where the logical and / or transport channel for a given message is known, it can be shown in front of the message name (*Logical\_Ch: Transport\_Ch: Message*). For example: DCCH:RACH:Acknowledged Data indicates a data message on DCCH mapped onto RACH. Either logical or transport channel can be omitted, if it is unspecified for the message.

## RRC Connection Establishment and Release Procedures

### RRC connection establishment - Case A

RRC connection establishment in common channel termination point case A (see /5/) is shown in Figure 7. The RRC layer in the UE leaves the idle mode and initiates an RRC connection establishment by sending an RRC Connection Request message using the MAC SAP for the CCCH logical channel. MAC transmits the L3 message on the RACH transport channel ~~enclosed in an Access Request L2 PDU.~~

**[Editor's Note: The L3 EG has adopted a working assumption to use an identity from the Non-Access Stratum (such as TMSI+LAI) included in the RRC Connection Request message. A PRACH physical random access channel capable of transmitting 32 kbps is estimated to be suitable for the message, guidance on the preferability of this data rate is sought from the physical layer EG. Other alternatives exist, such as a random number.]**

On the network side, upon the reception of RRC Connection Request, the RRC layer performs admission control, assigns an s-RNTI for the RRC connection and selects radio resource parameters (such as transport channel type, transport format sets etc). If a DCH is to be established, an ~~CPHYMPH--RL-S~~ setup request is sent to all Node B:s which would be involved in the channel establishment. The physical layer operation is started and a confirmation primitive is returned from each Node B. RRC configures parameters on layer 2 to establish the DCCH logical channel locally. The selected parameters including the RNTI, are transmitted to the UE in an RRC Connection Setup message using the MAC SAP for the CCCH logical channel ~~(which in turn is mapped by SRNC MAC into an Access Grant message on the FACH transport channel).~~

Upon reception of the RRC Connection Setup message, the RRC layer in the UE configures the L1 and L2 using these parameters to locally establish the DCCH logical channel. In case of DCH, layer 1 indicates to RRC when it has reached synchronisation. The need for the synchronisation indication on the network side is FFS and depends on e.g. the method of L2 link establishment.

The RLC signalling link can be either implicitly established and used for the transmission of a complete message from L3, or the establishment can be done with explicit signalling triggered by an establish request from L3. The establishment can be mapped on either RACH / FACH, RACH+FAUSCH / FACH or DCH by MAC. The need for explicit establishment is FFS.



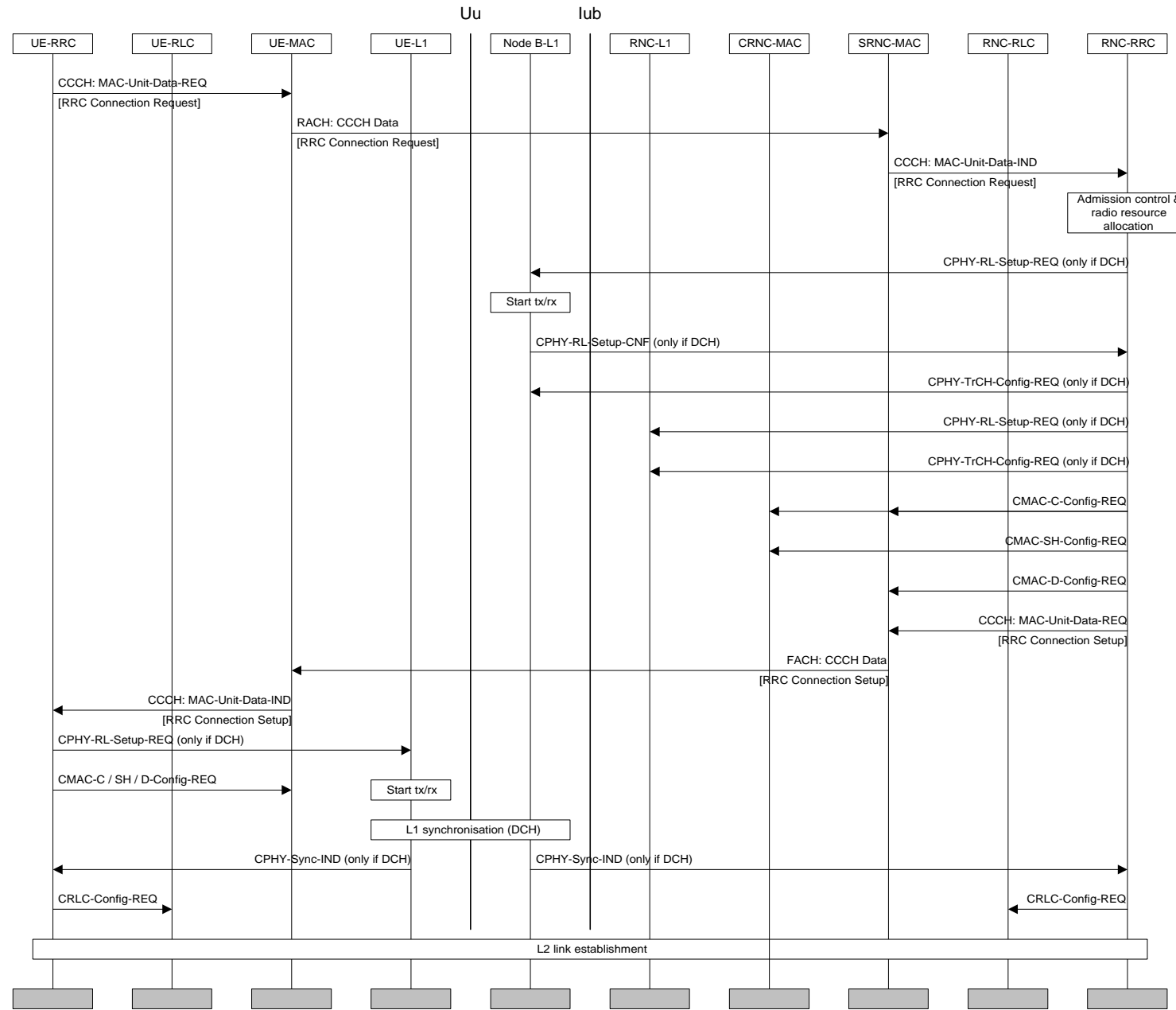

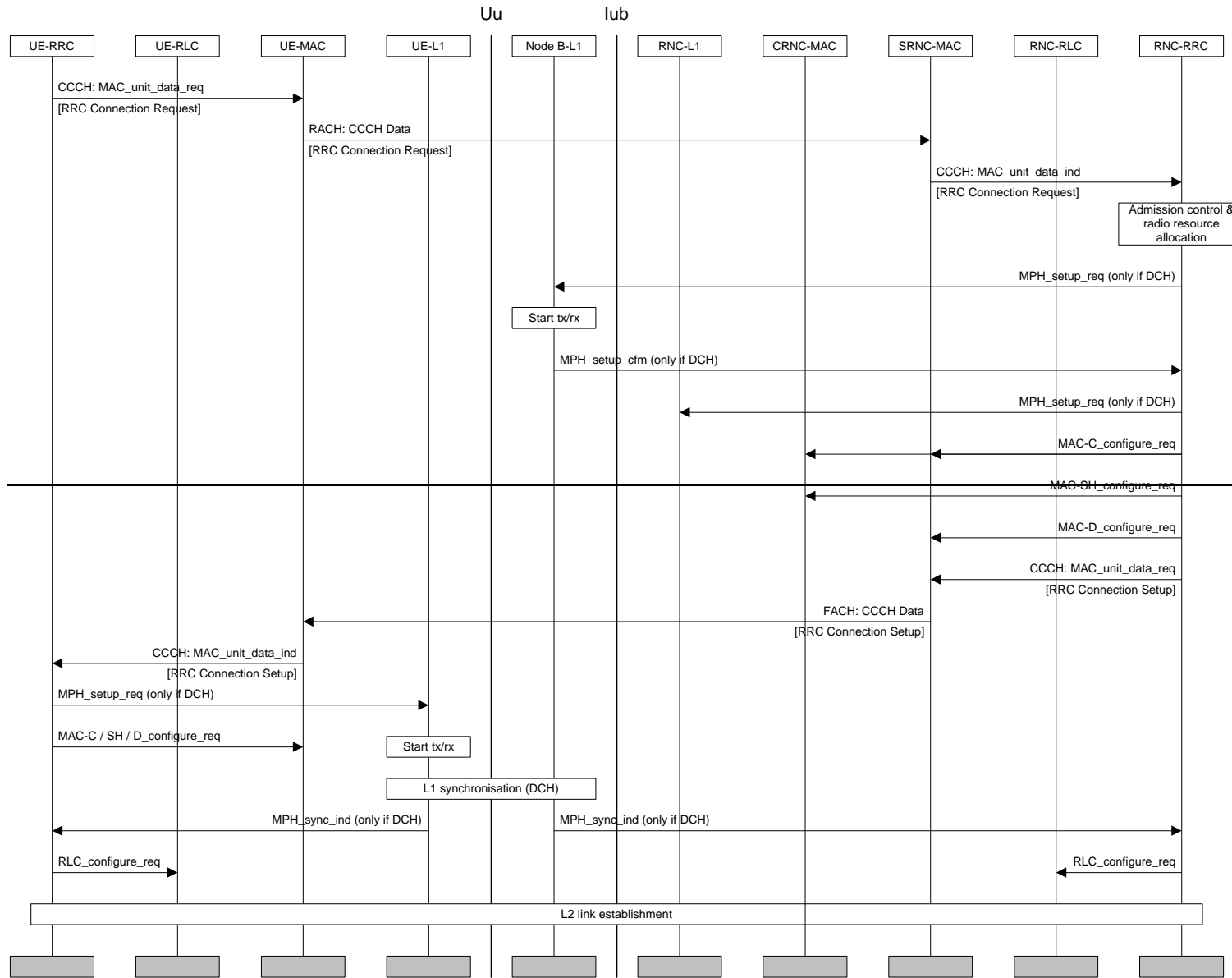
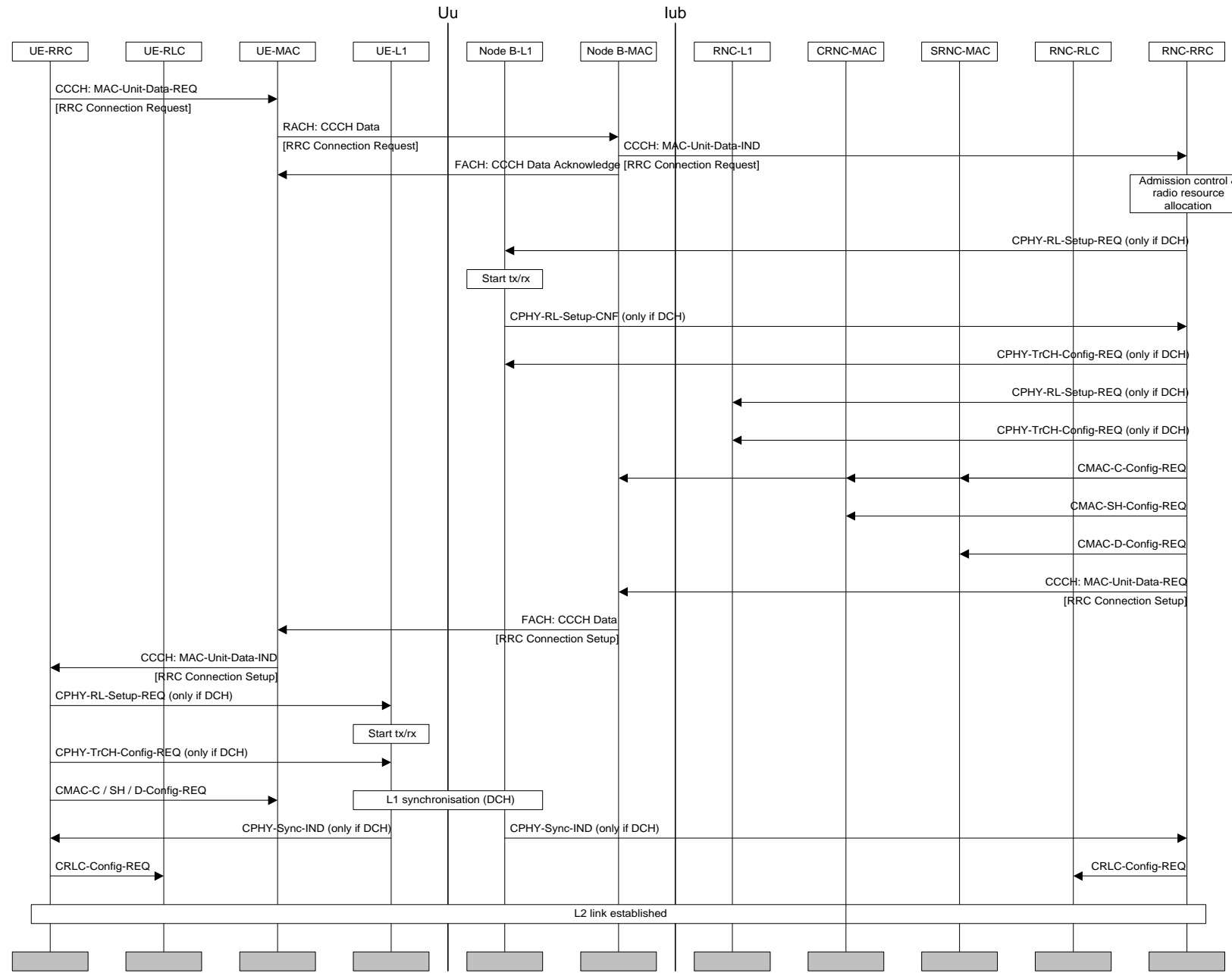

Figure 7. RRC connection establishment with common channel termination case A



## RRC connection establishment - Case C





**Figure 8: RRC connection establishment with common channel termination case C**

The difference between case A and case C common channel termination points is that in case C RACH and FACH transport channels are terminated in Node B. An Access Acknowledgement message is sent from Node B to the UE to acknowledge the reception of the Access request. Similarly, the Access Grant message from the network is transmitted via the Node-B MAC.

## UE Initiated Signalling Connection Establishment

The sequence in Figure 9 shows the establishment of the first Signalling Connection for the UE, initiated by the UE. *[Note1: The establishment of a second, simultaneous Signalling Connection for the UE is FFS, e.g. in the case of GPRS and non-GPRS Core Network domains].*

RRC Signalling Connection Establishment is requested by the non access stratum in the UE with a primitive over the Dedicated Control (DC) SAP. The primitive contains an initial message to be transferred transparently by RRC to the non-access stratum entity on the network side. *[Note2: The initial NAS message could for a GSM based Core Network be e.g. CM Service Request, Location Update Request etc.]*

If no RRC connection exists, the RRC layer makes an RRC connection establishment. When the RRC connection establishment is completed, the signalling connection establishment can be resumed. The transmission of UE capability information can be triggered by the UTRAN (see 0), if this information doesn't exist within UTRAN yet.

The initial message from NAS is transferred in the RRC message "Transparent Message" using acknowledged mode on the DCCH, to the network, where it is passed on with an RRC Signalling Connection Establish IND primitive over the DC-SAP. *[Note3: The necessity for a separate RRC message for encapsulating NAS messages is FFS].* When the initial NAS message has been transferred successfully, as indicated by the RLC-Data-CNF primitive in the UE, the Signalling Connection Establishment is confirmed by the UE-RRC.

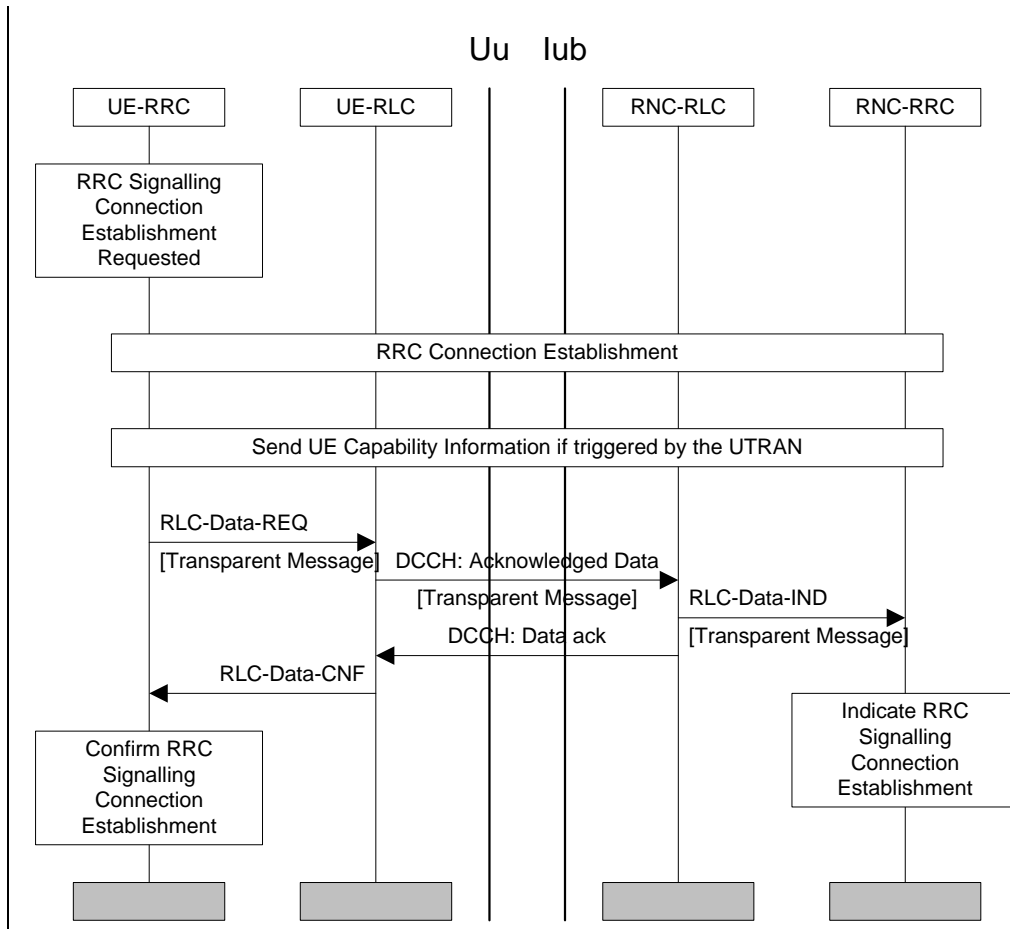

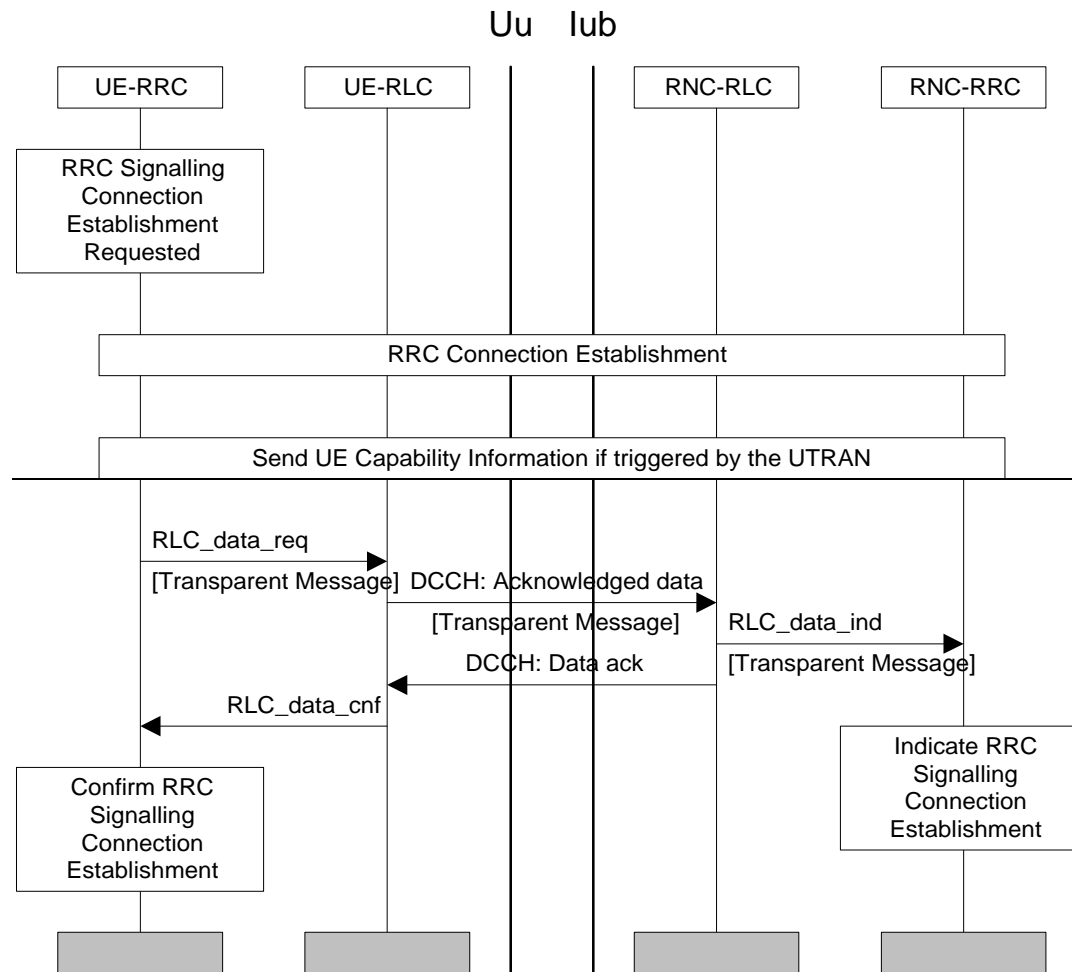
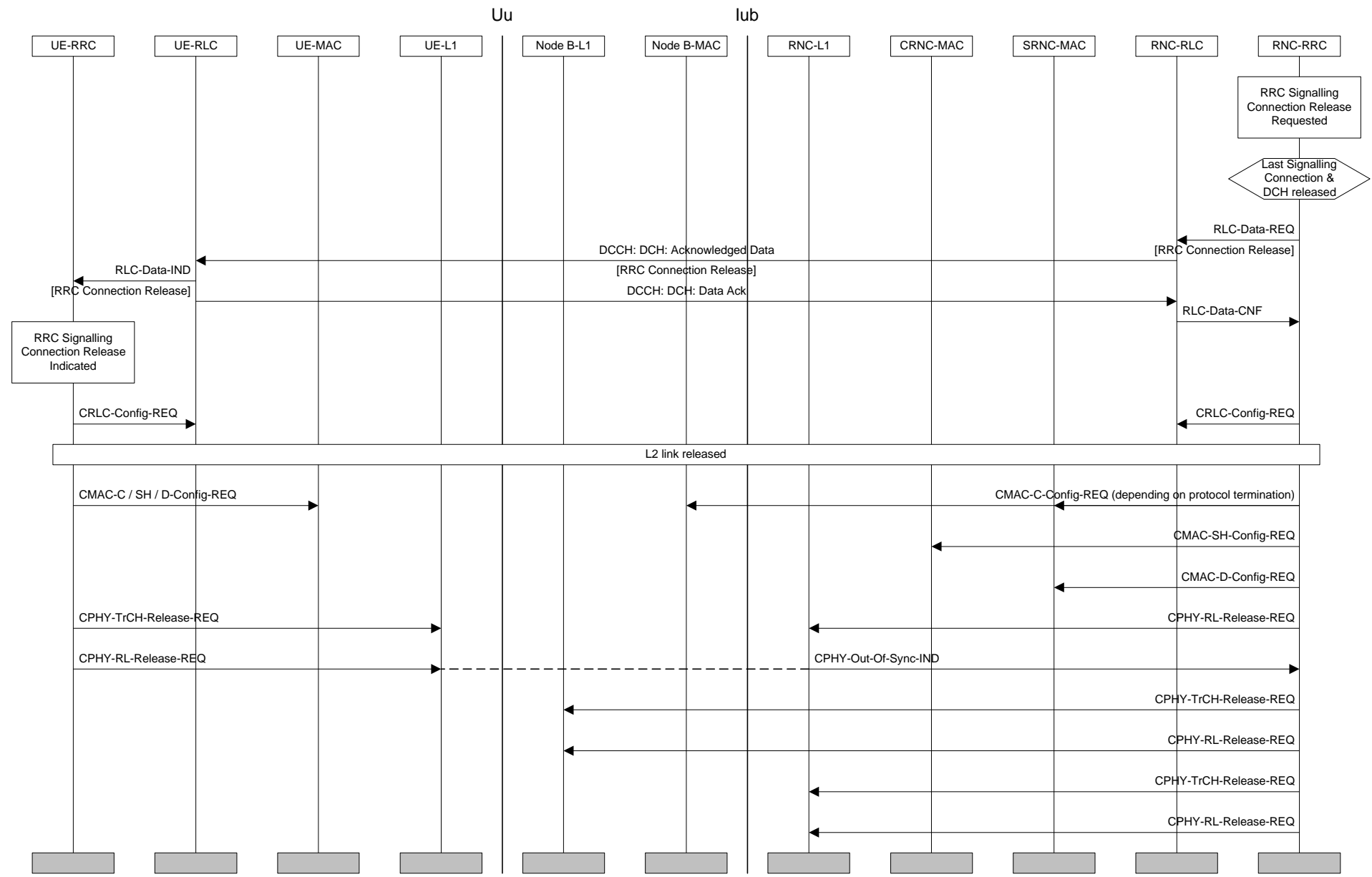

Figure 9. UE initiated Signalling Connection Establishment

## Normal RRC Connection Release

A normal RRC Connection Release procedure is initiated on the network side by an RRC Signalling Connection Release request for the last Signalling Connection of a UE. The procedure is slightly different depending on whether the UE has dedicated physical channel(s) allocated.

RRC Connection Release from Dedicated Physical Channel





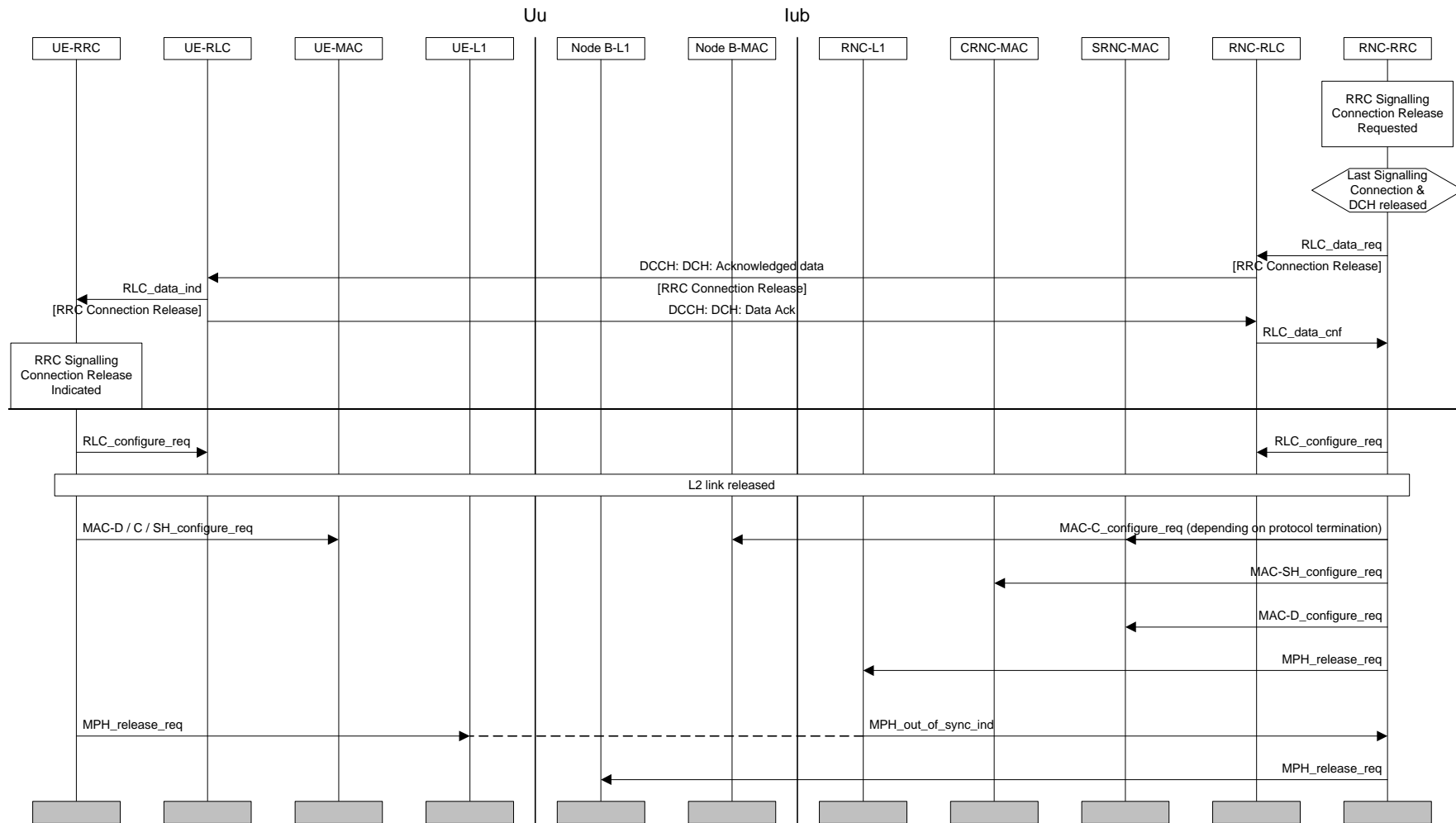

**Figure 10. RRC Connection Release from Dedicated Physical Channel**

The RRC layer entity in the network issues an RRC CONNECTION RELEASE message using acknowledged mode on the DCCH. Upon reception of this message the UE-RRC sends an RRC Signalling Connection Release Indication primitive to NAS and requests the release of the radio link(s), MAC and RLC(s). After that the UE RRC enters Idle Mode.

The release of the signalling link is detected in the UTRAN by the out-of-sync primitive from Node-B L1 to RNC RRC. After receiving this primitive, the RNC-RRC layer releases L2 and L1 resources on the network side and enters the idle mode.

## RRC Connection Release without Dedicated Physical Channel

The RRC layer entity in the network issues an RRC CONNECTION RELEASE message using unacknowledged mode on the DCCH. Upon reception of this message the UE-RRC sends an RRC Signalling Connection Release Indication primitive to NAS and an RRC CONNECTION RELEASE COMPLETE message to UTRAN using acknowledged mode on the DCCH.

After receiving the RRC CONNECTION RELEASE COMPLETE message the network RRC layer releases L2 resources, sends an RRC Signalling Connection Release confirmation to DC-SAP and goes to Idle Mode (more precisely: only the RRC entity dedicated to this UE goes to Idle Mode).

[Note: Depending on RLC design, the acknowledgement to RRC CONNECTION RELEASE could be piggybacked to the RRC CONNECTION RELEASE COMPLETE MESSAGE, resulting in no additional messages. Therefore acked / unacked transmission is considered FFS.]

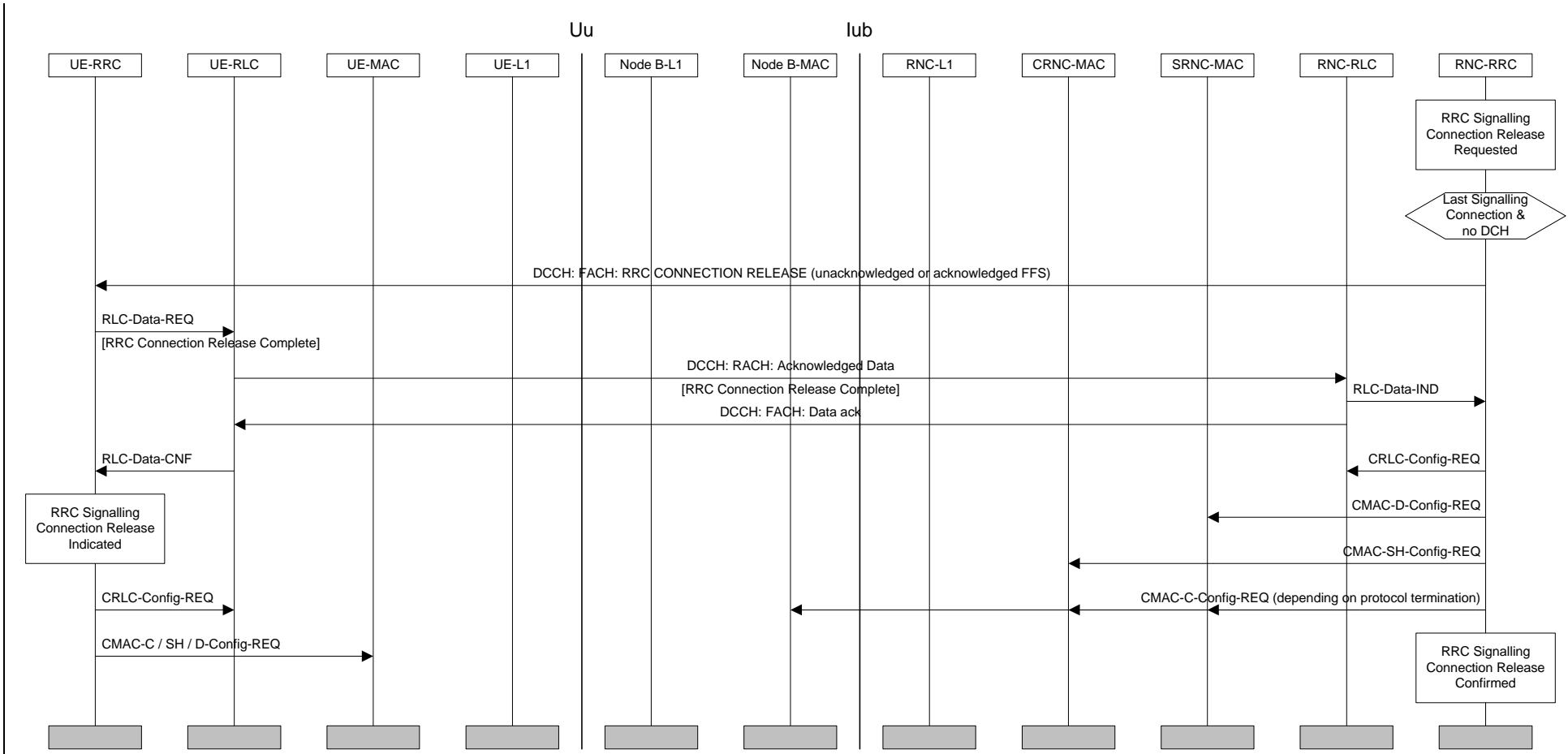

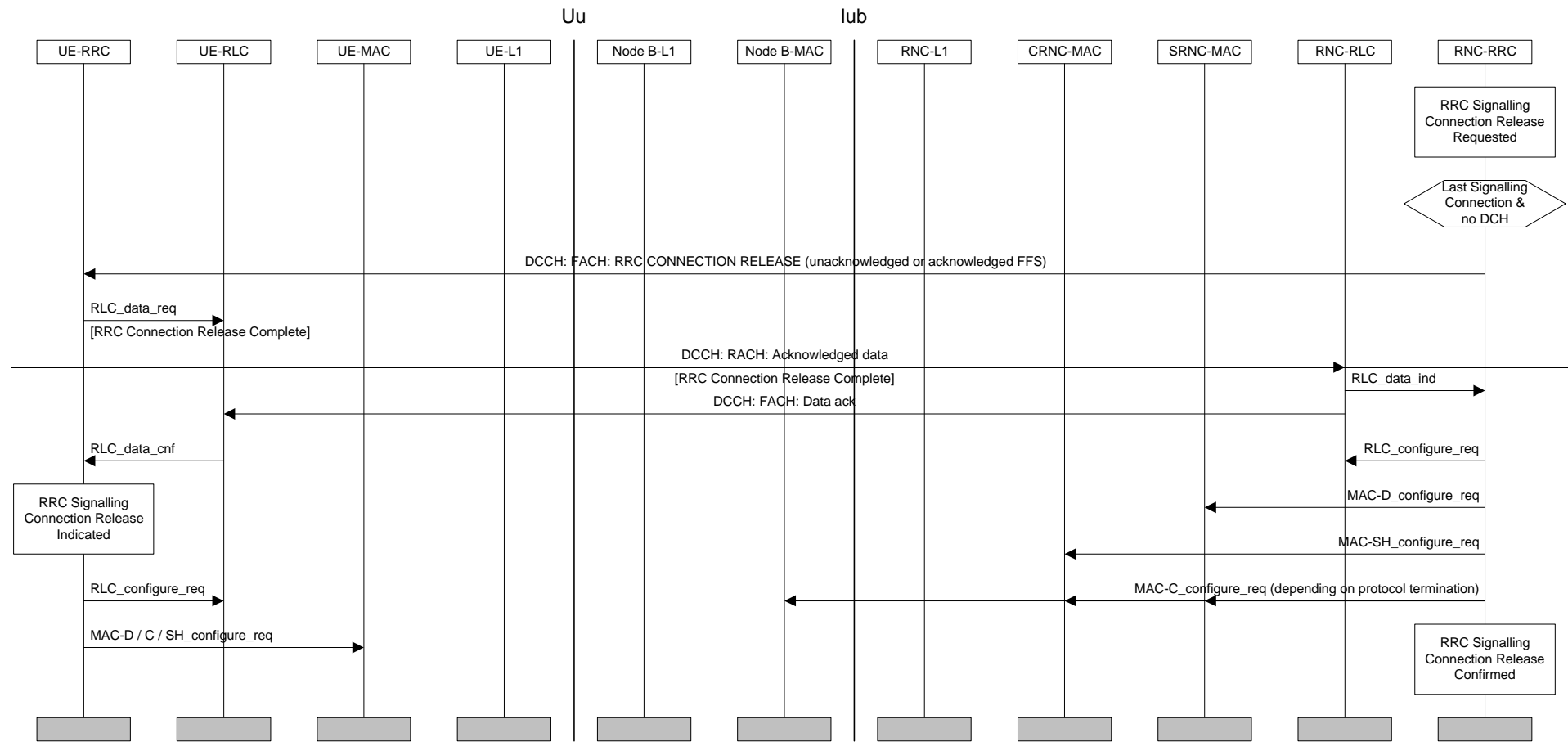

Figure 11: RRC Connection Release without Dedicated Physical Channel

## Radio Access Bearer Procedures

### Radio Access Bearer Configuration

#### Radio Access Bearer Establishment

The procedures for establishing radio access bearers may vary according to the relation between the radio access bearer and a dedicated transport channel. Depending on the QoS parameters, there may or may not be a permanently allocated dedicated channel associated with the RAB. Circuit-switched bearers, or bearers classified as real-time services typically need a permanent association to a DCH to meet the delay requirements. Packet-switched bearers, or bearers classified as non-real-time services can in many cases be served as best-effort, requesting capacity from an associated DCH based on need.

When establishing a RAB together with a DCH, the DCH may be attached to either a newly activated physical channel or it may be accommodated by modifying an existing physical channel. The modification is further broken down into two different options: synchronised and unsynchronised. If the old and new physical channel settings are compatible (TFCI etc.) in the sense that executing the modification in the NW and the UE with arbitrary timing does not introduce transmission errors, the unsynchronised procedure can be applied. If the old and new settings are incompatible, due to e.g. assignment of the same TFCI value to a new set of physical layer configuration, the synchronised procedure must be used.

Radio Access Bearer Establishment with Dedicated Physical Channel Activation

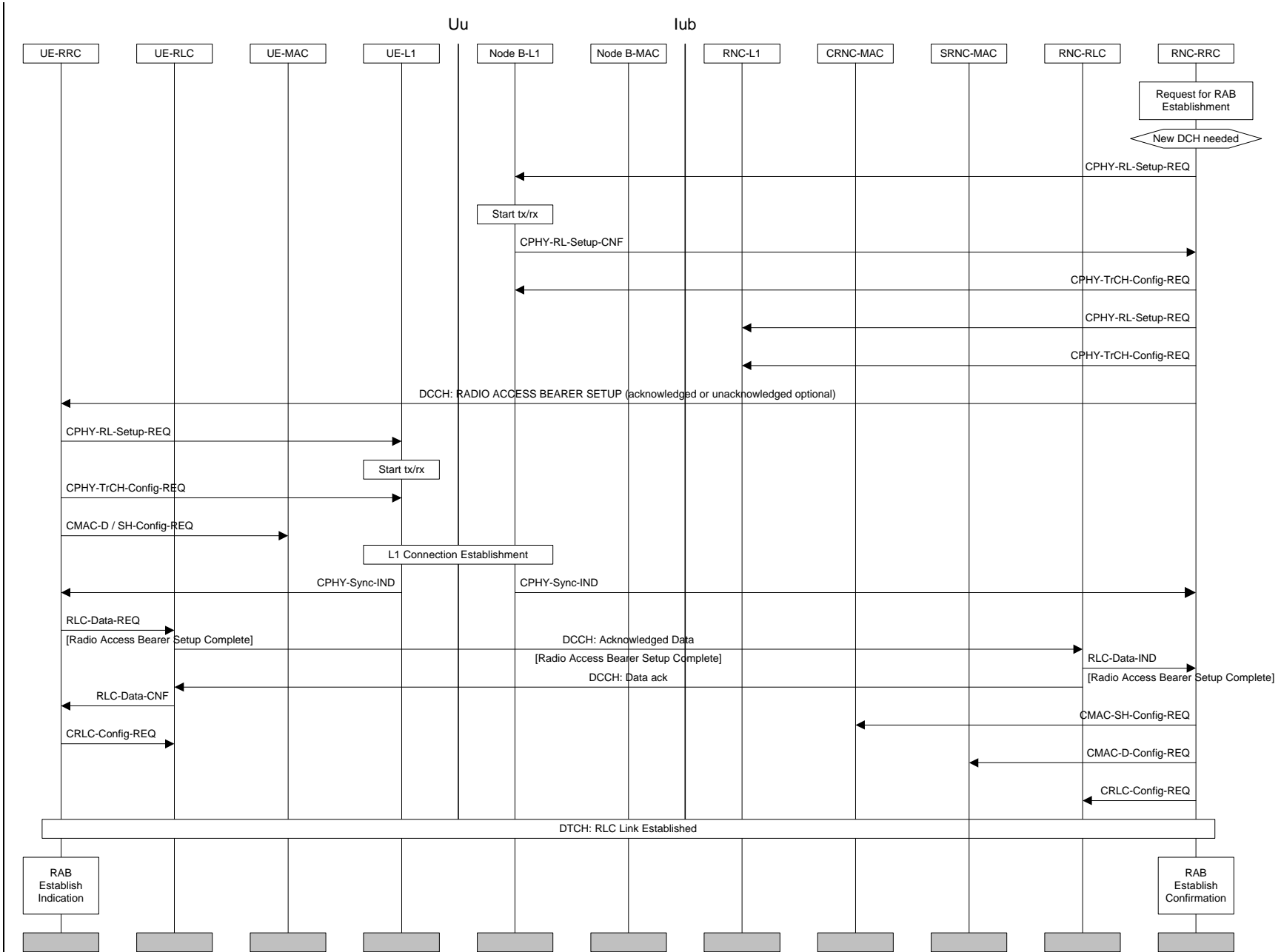





The procedure in Figure 12 is applied when a new physical channel needs to be created for the radio access bearer. A Radio Access Bearer Establishment is initiated when an RAB Establish Request primitive is received from the DC-SAP on the network side of the RRC layer. This primitive contains a bearer reference and QoS parameters. Based on these QoS parameters, L1 and L2 parameters are chosen by the RRC entity on the network side.

The physical layer processing on the network side is started with the ~~CPHYMPH-RL-S~~ setup request primitive issued to all applicable Node B:s. If any of the intended recipients is / are unable to provide the service, it will be indicated in the confirmation primitive(s). After setting up L1 including the start of tx / rx in Node B, the NW-RRC sends a RADIO ACCESS BEARER SETUP message to its peer entity (acknowledged or unacknowledged transmission optional for the NW). This message contains L1, MAC and RLC parameters. After receiving the message, the UE-RRC configures L1 and MAC.

When L1 synchronisation is indicated [*Note: Need for sync\_ind on NW-side FFS*], the UE sends a RADIO ACCESS BEARER SETUP COMPLETE message in acknowledged-mode back to the network. The NW-RRC configures MAC and RLC on the network side.

After receiving the confirmation for the RADIO ACCESS BEARER SETUP COMPLETE, the UE-RRC creates a new RLC entity associated with the new radio access bearer. The applicable method of RLC establishment may depend on RLC transfer mode. The RLC connection can be either implicitly established, or explicit signalling can be applied. The exact procedure is FFS. [*Note2: Not needed for transparent mode but may be needed for non-transparent mode.*]

Finally, an RAB Establish Indication primitive is sent by UE-RRC and an RAB Establish Confirmation primitive is issued by the RNC-RRC.

Radio Access Bearer Establishment with Unsynchronised Dedicated Physical Channel Modification

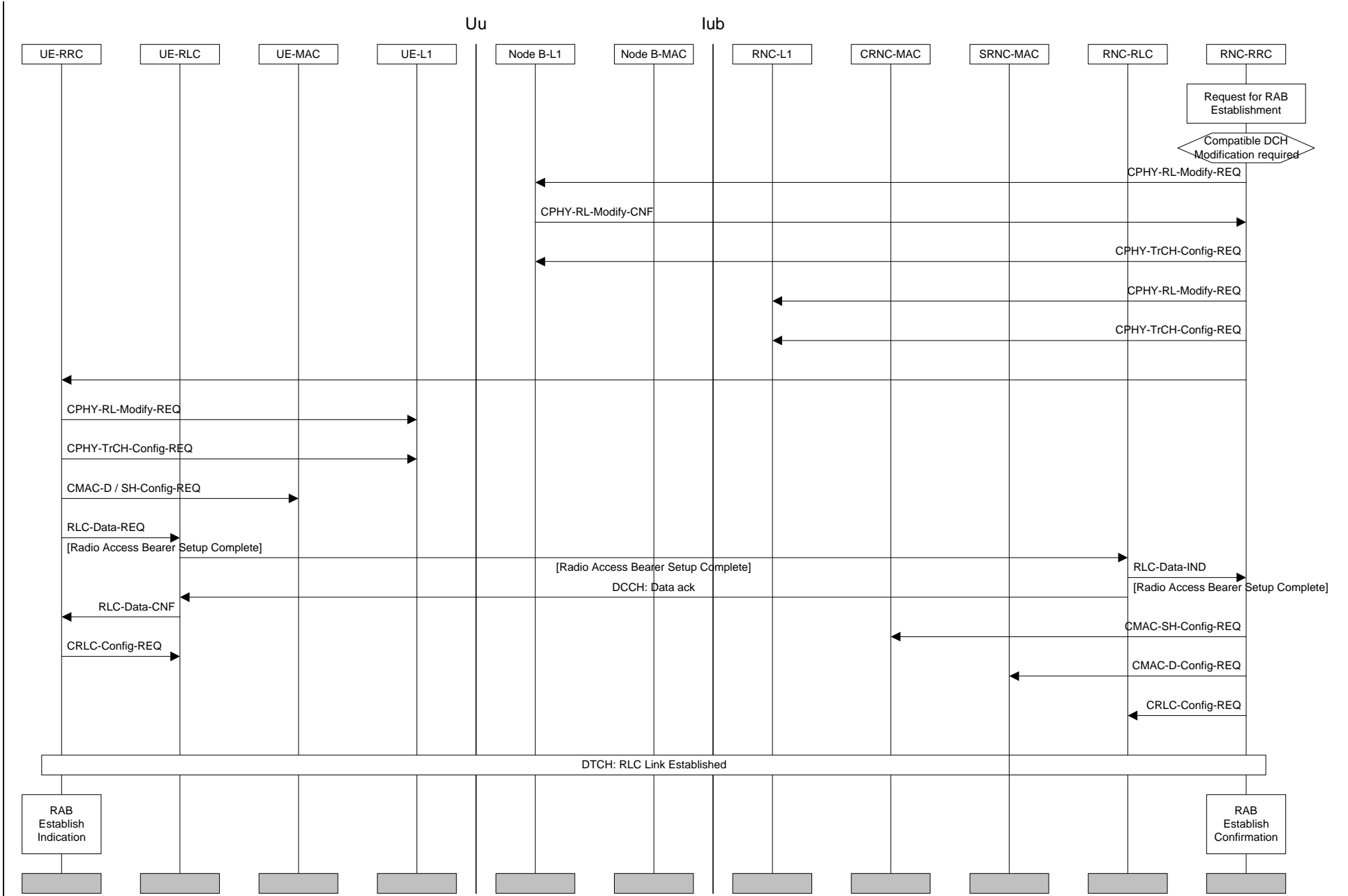

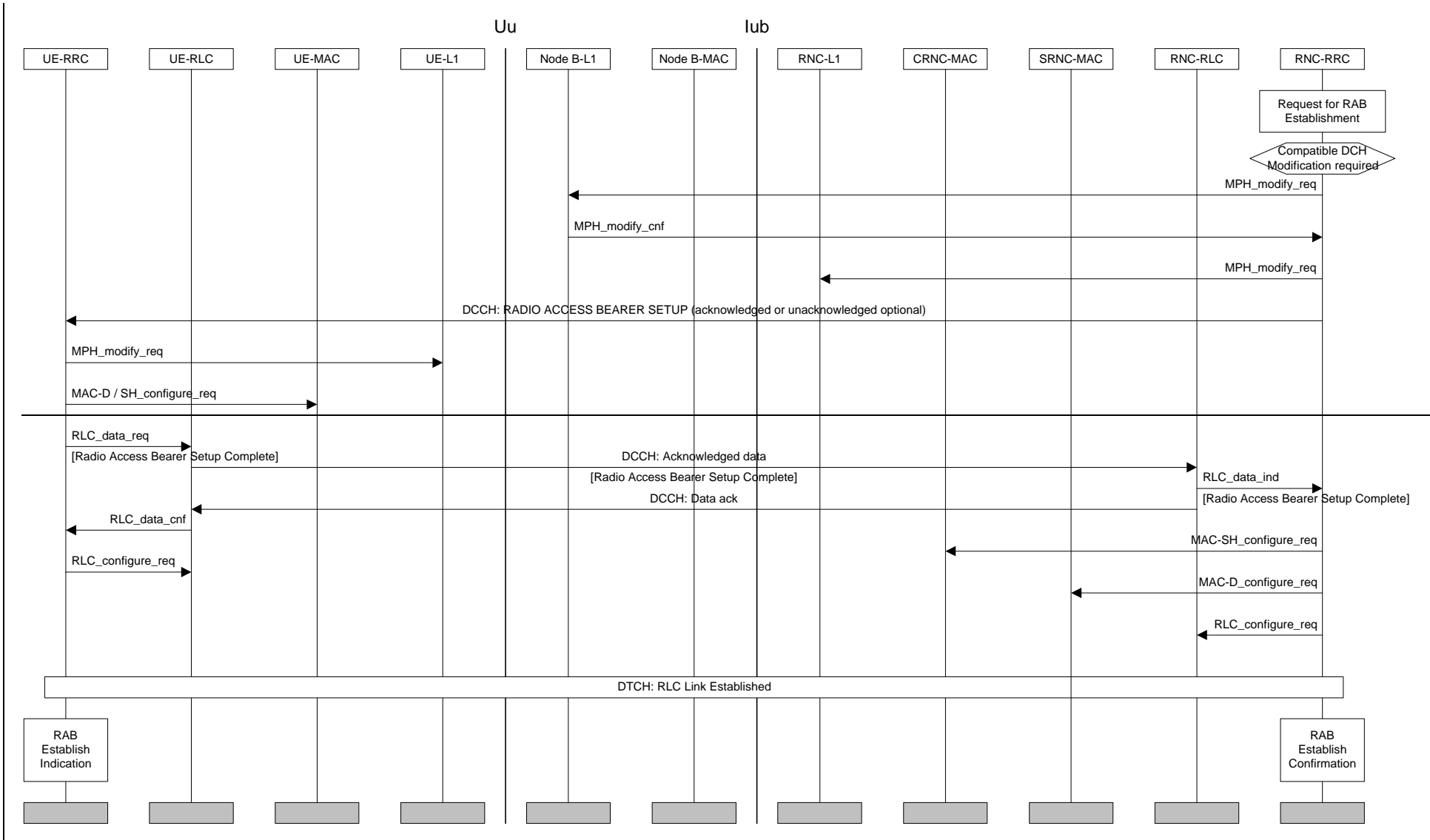

**Figure 13: Radio Access Bearer Establishment with Unsynchronised Dedicated Physical Channel Modification**

The establishment of a radio access bearer, when unsynchronised physical channel modification is applicable, is shown in Figure 13. If the old and new physical layer configurations are compatible in the sense that they can coexist in the peer entities, an unsynchronised procedure for radio access bearer establishment can be applied. In this case

no fixed activation time is required.

The modifications on the physical layer in the network are done in response to an CPHYMPH modify request. Failure to comply is indicated in the confirmation primitive. In an error-free case the RADIO ACCESS BEARER SETUP message on L3 is transmitted. Acknowledged or unacknowledged transmission is a network option. Configuration changes on the UE-side proceed after this message has been received. Reception of the RADIO ACCESS BEARER SETUP COMPLETE message triggers configuration changes in MAC and RLC in the network.

Radio Access Bearer Establishment with Synchronised Dedicated Physical Channel Modification



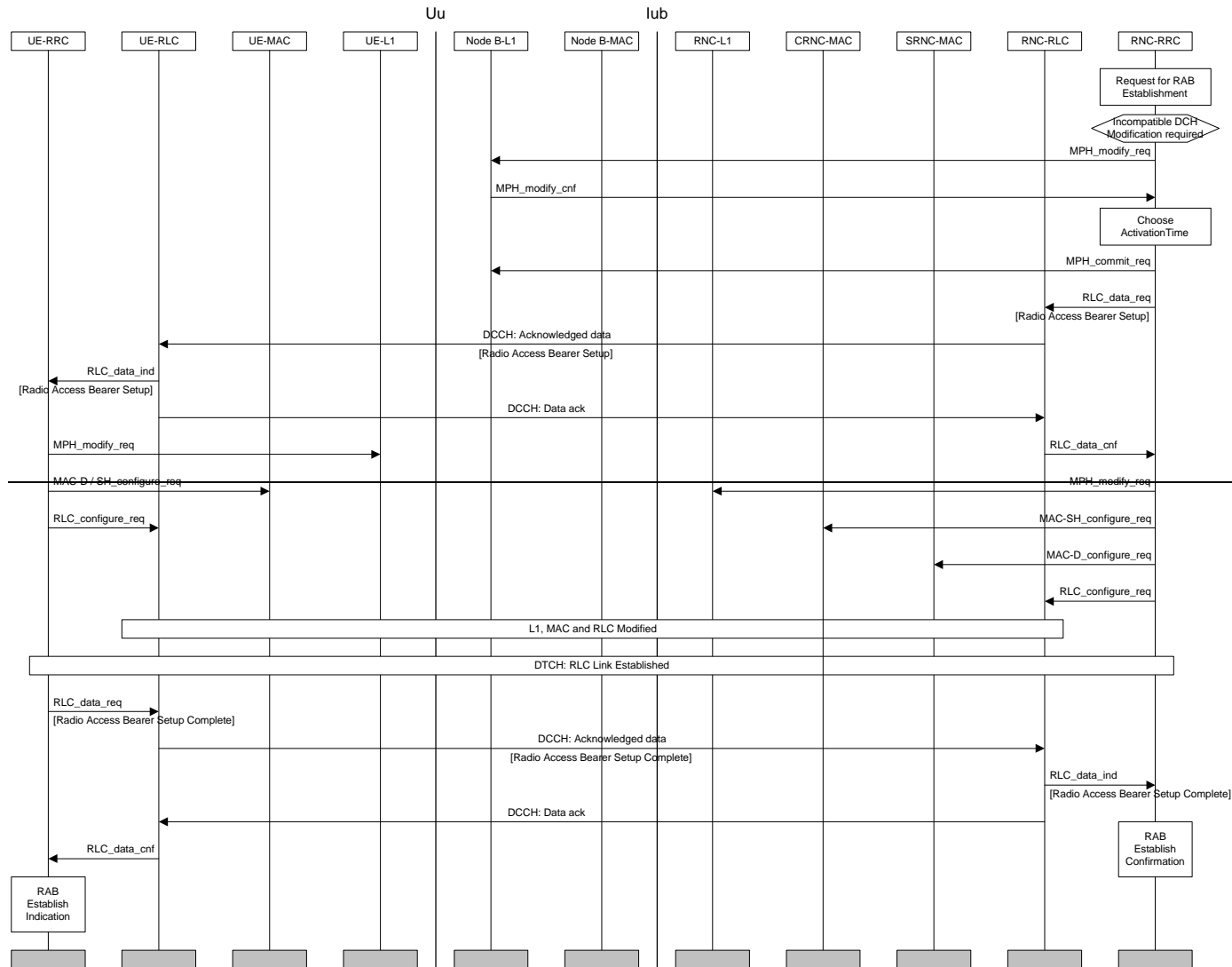

**Figure 14: Radio Access Bearer Establishment with Synchronised Dedicated Physical Channel Modification**

In case the old and the new physical channel configurations are incompatible with each other (due to different DPCCCH format, TFCI patterns or similar differences), the modification on physical layer and L2 require exact synchronisation between the UE and the NW, as shown in Figure 14.



In this case the ~~CPHYMPH\_RL\_M~~ modify request doesn't immediately cause any changes in the physical layer configuration, it only checks the availability of the requested configuration and makes a "reservation". After the confirmations have been received from all applicable Node B:s, the RRC chooses the appropriate "activation time" when the new configuration can be activated. This information is signalled to MAC, RLC and also the physical layer (~~CPHYMPH\_C~~ commit request primitive).

After the RADIO ACCESS BEARER SETUP message (acknowledged transmission on L2 required) between peer L3 entities the setup proceeds on the UE-side. The new configuration is now available both on the UE and the network side, and at the scheduled activation time the new configuration is assumed by all applicable peer entities. *[Note: The method of synchronisation is a subject of current study.]*

Radio Access Bearer Establishment without Dedicated Physical Channel

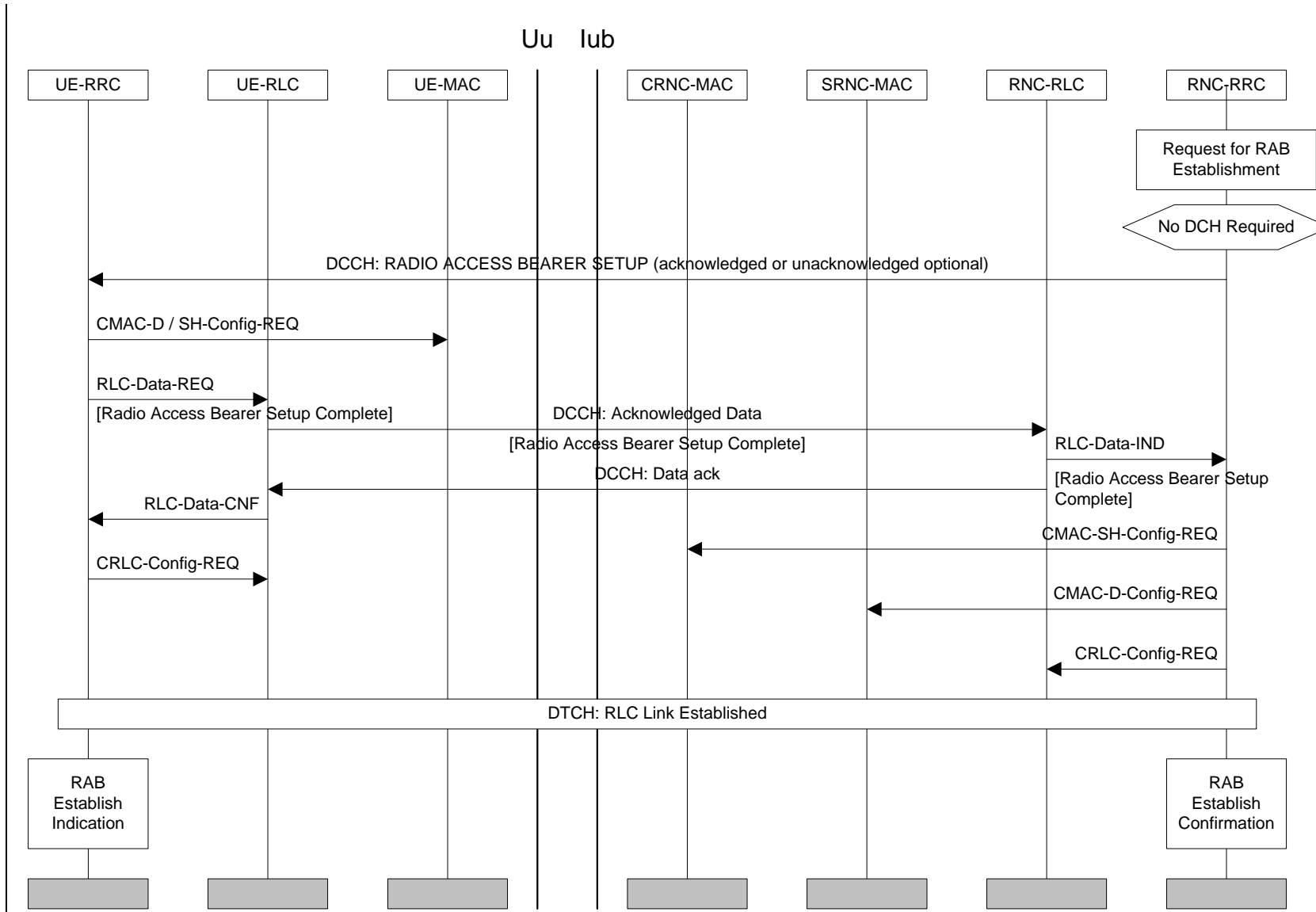

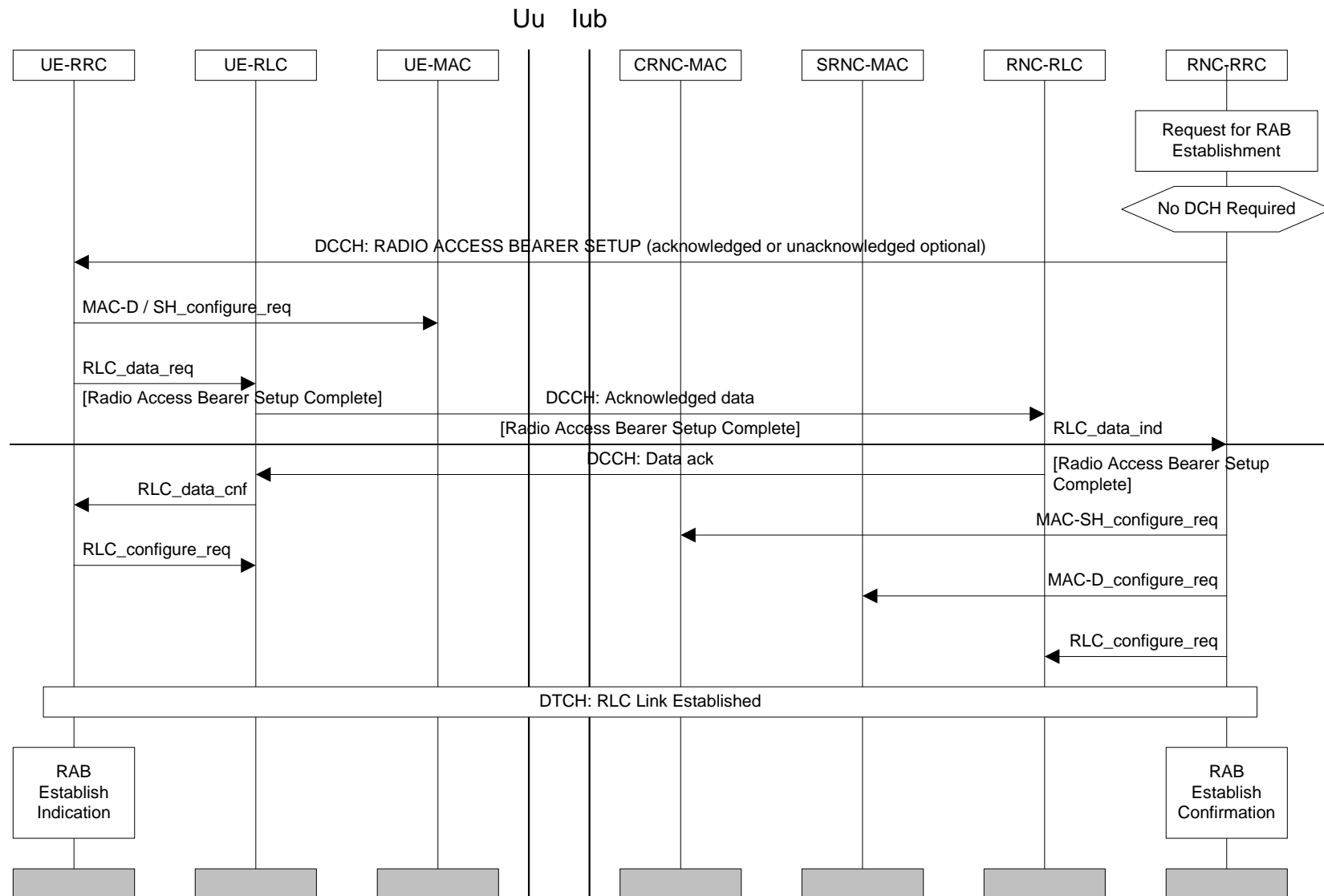

**Figure 15: Radio Access Bearer Establishment without Dedicated Physical Channel**

For some radio access bearers dedicated radio resources are not permanently associated. Therefore the setting up of the physical resource is separate from the actual radio access

bearer setup, which involves only RLC and MAC.

MAC can be initially configured to operate either on existing dedicated transport and physical channels or on common channels.

## Radio Access Bearer Release

Similar as for Radio Access Bearer Establishment procedure, the Radio Access Bearer Release can include physical channel modification or physical channel deactivation depending on the differences between new and old QoS parameters. These can also be both synchronised and unsynchronised.

The Radio Access Bearer Release procedure is initiated when the release is requested from the RRC layer on the NW side. This request contains a bearer reference, and on retrieval a RAB Release Confirm primitive is immediately returned to the Non-Access Stratum.

New L1 and L2 parameters may be chosen for remaining radio access bearers if any. A RADIO ACCESS BEARER RELEASE message is sent from the RRC layer in the network to its peer entity in the UE. This message includes possible new L1, MAC and RLC parameters for remaining radio access bearers and identification of the radio access bearer to be released. *[Note1: In synchronised case a specific activation time would be needed for the change of L1 and L2 configuration to avoid data loss.]* A RAB Release Indication is sent by the UE-RRC.

The RRC on the UE side configures L1 and MAC, and releases the RLC entity associated to the released radio access bearer. After receiving a RADIO ACCESS BEARER RELEASE COMPLETE message from the UE, the NW-RRC does a similar reconfiguration also on the network side.

### Radio Access Bearer Release with Unsynchronised Dedicated Physical Channel Modification

The example in Figure 16 shows the case where release can be executed as an unsynchronised physical channel modification, i.e. without physical channel deactivation.

After notifying upper layers of the release, a RADIO ACCESS BEARER RELEASE message (acknowledged or unacknowledged transmission optional for the network) is sent to the UE triggering the reconfiguration in the UE. When this is finalised the UE sends a RADIO ACCESS BEARER RELEASE COMPLETE message to the network, after which the reconfiguration is executed in the network.

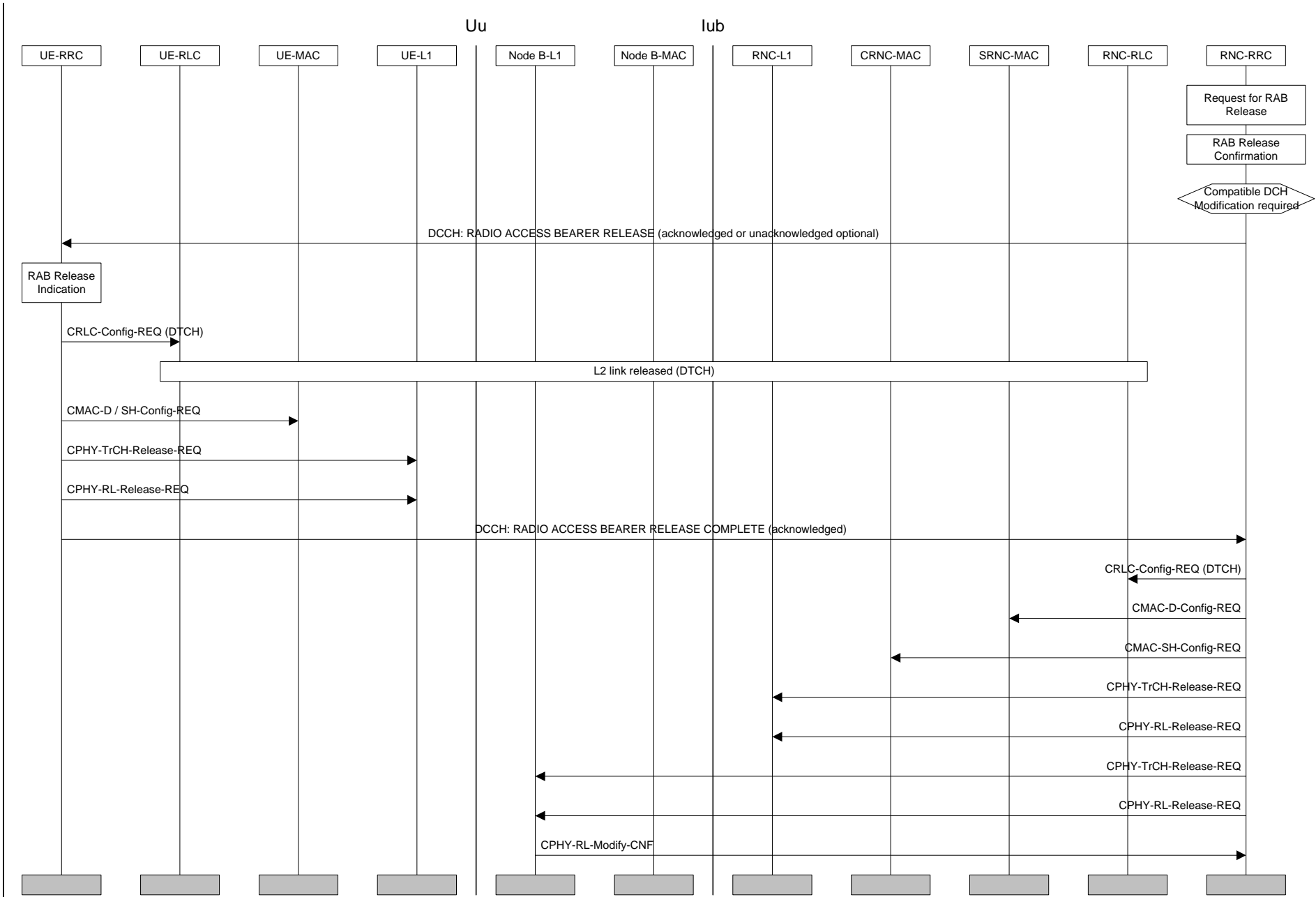

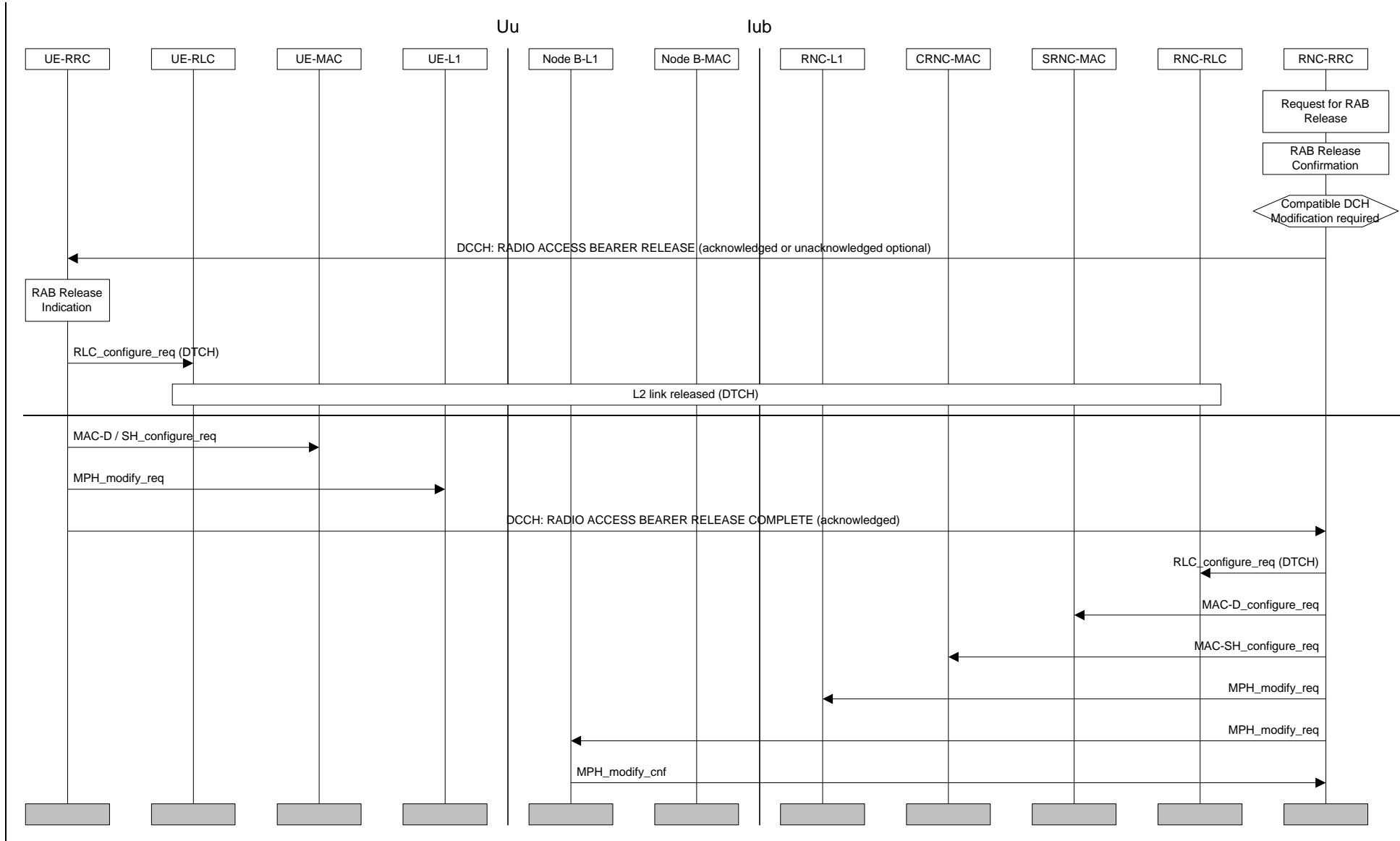

Figure 16: Radio Access Bearer Release with Unsynchronised Dedicated Physical Channel Modification

## Bearer Reconfiguration

For Bearer Reconfiguration, both synchronised and unsynchronised procedures are applicable. The unsynchronised procedure is shown as an example.

### Unsynchronised Radio Access Bearer And Signalling Link Reconfiguration

Because of the unsynchronised nature of the procedure in Figure 17, there is no activation time and no separate commit request for the Node B physical layer is needed. The possibility for executing the requested modification will be reported in the confirmation primitives from the physical layer. If the modification involves the release of an old configuration, the release can be postponed to the end of the procedure. After the reception of a RADIO ACCESS BEARER AND SIGNALLING LINK RECONFIGURATION REQUEST from the RNC-RRC (acknowledged or unacknowledged transmission optional for the network), the UE executes the modifications on L1 and L2.

Upon reception of a RADIO ACCESS BEARER AND SIGNALLING LINK RECONFIGURATION COMPLETE message from the UE-RRC, the NW-RRC executes the modifications on L1 and L2. Finally the old configuration, if any, is released from Node B-L1.



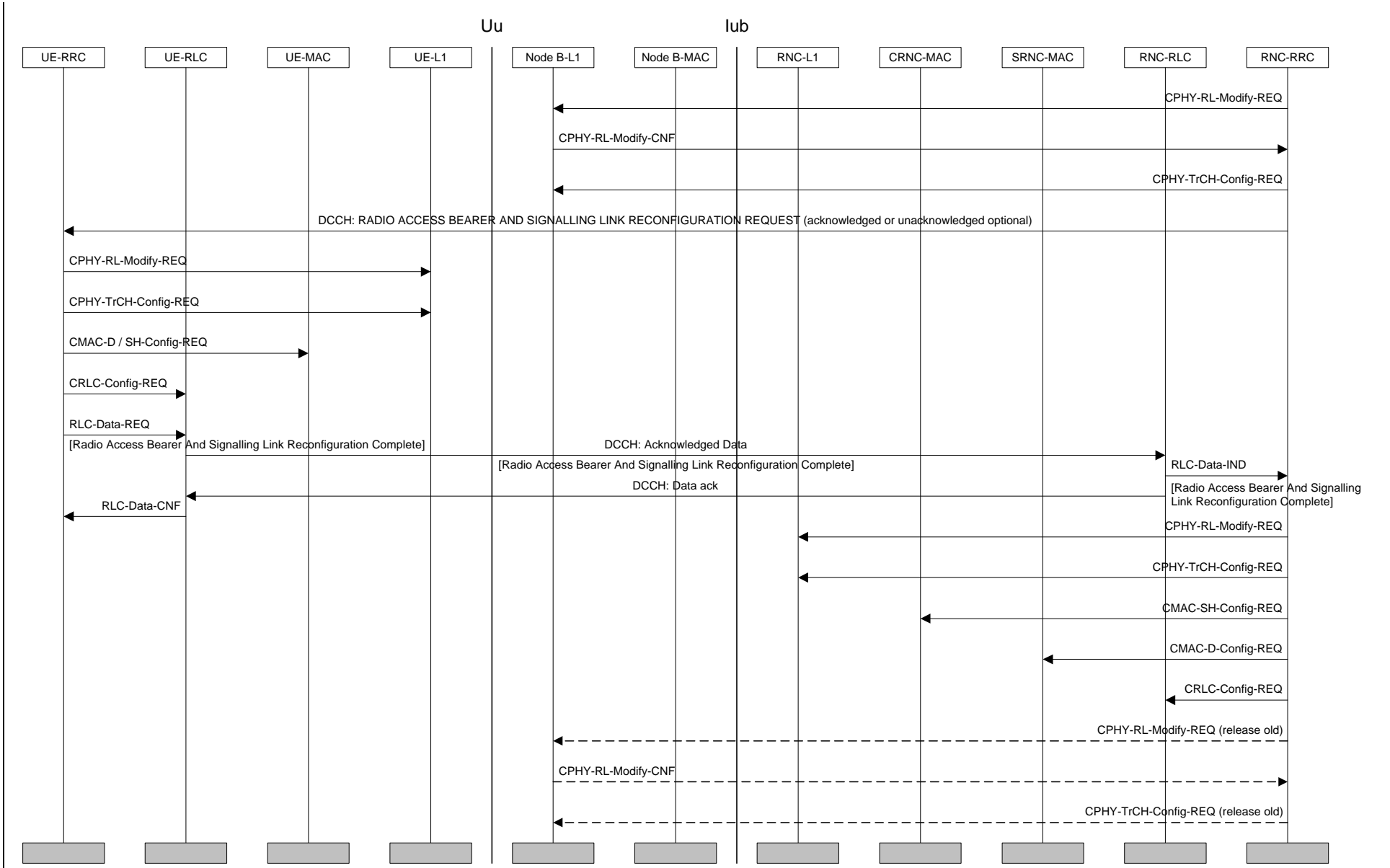



Unsynchronised Transport Format Set Reconfiguration

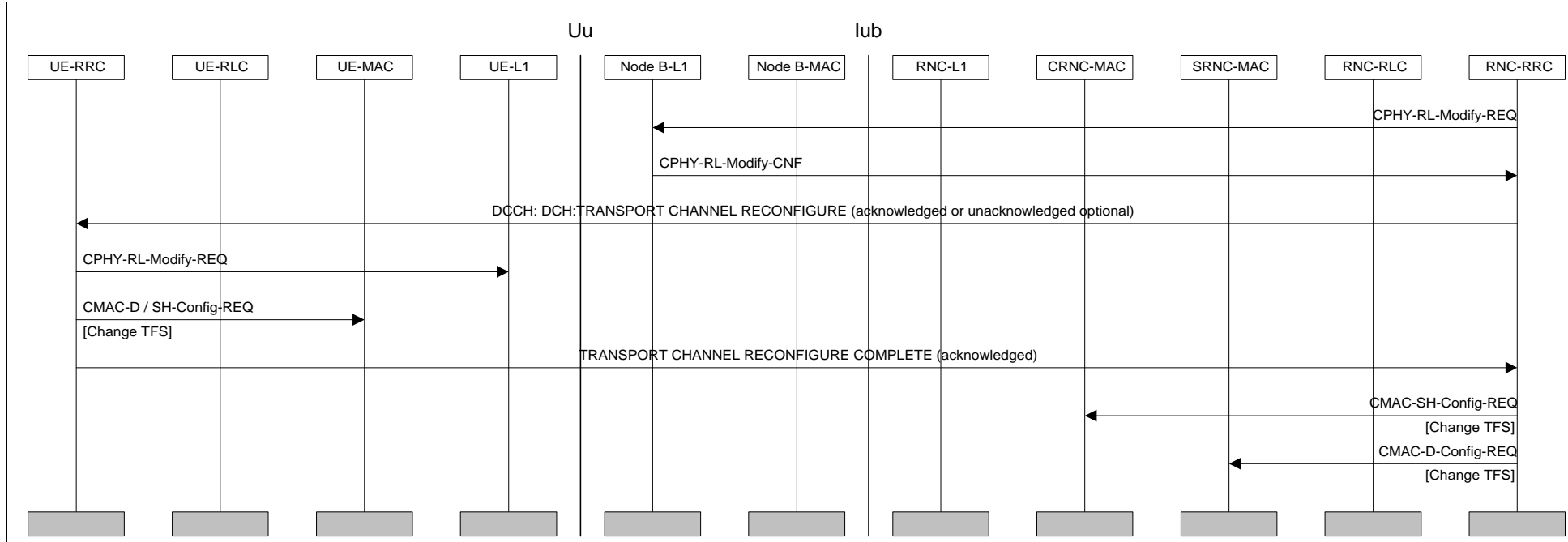





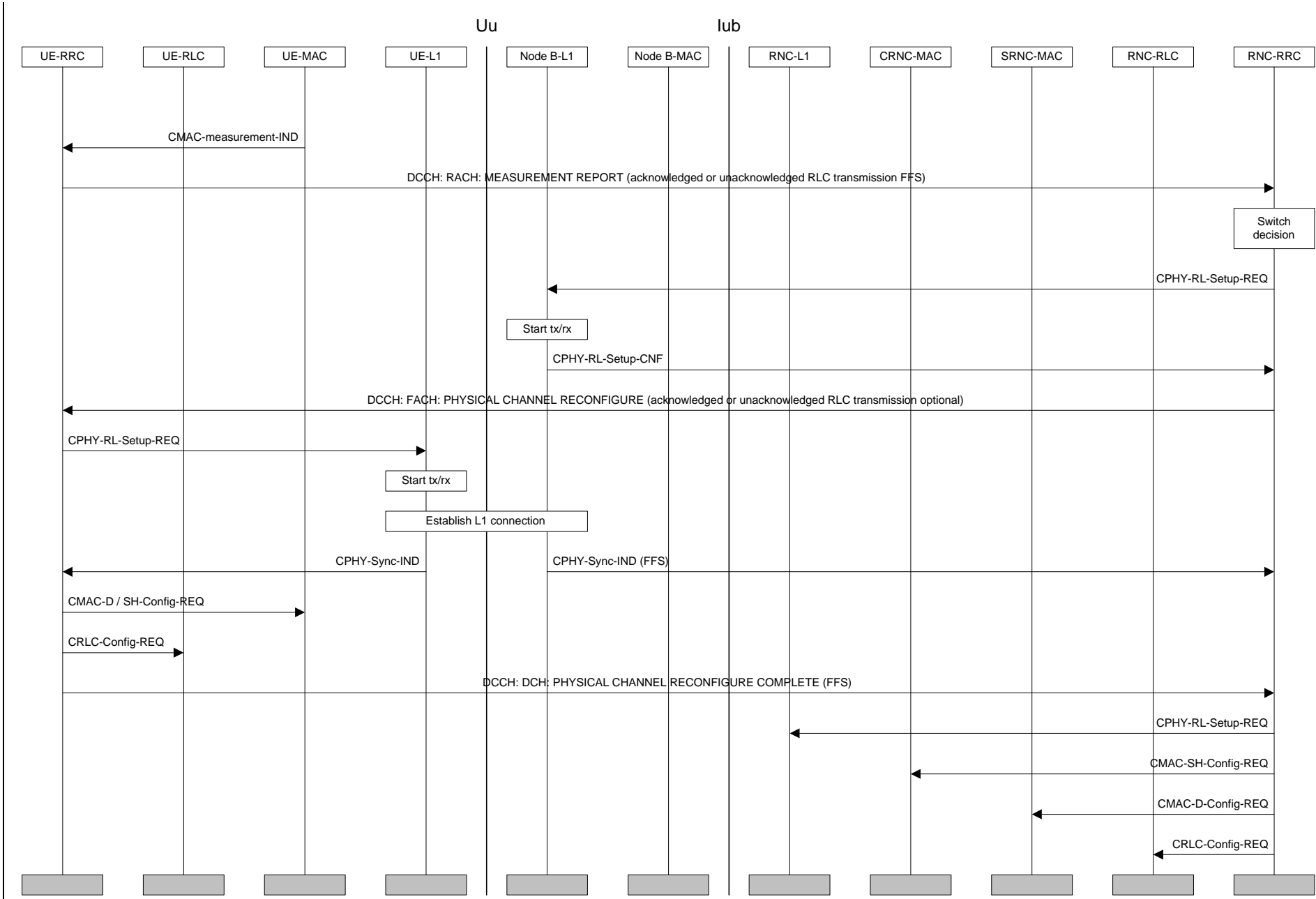

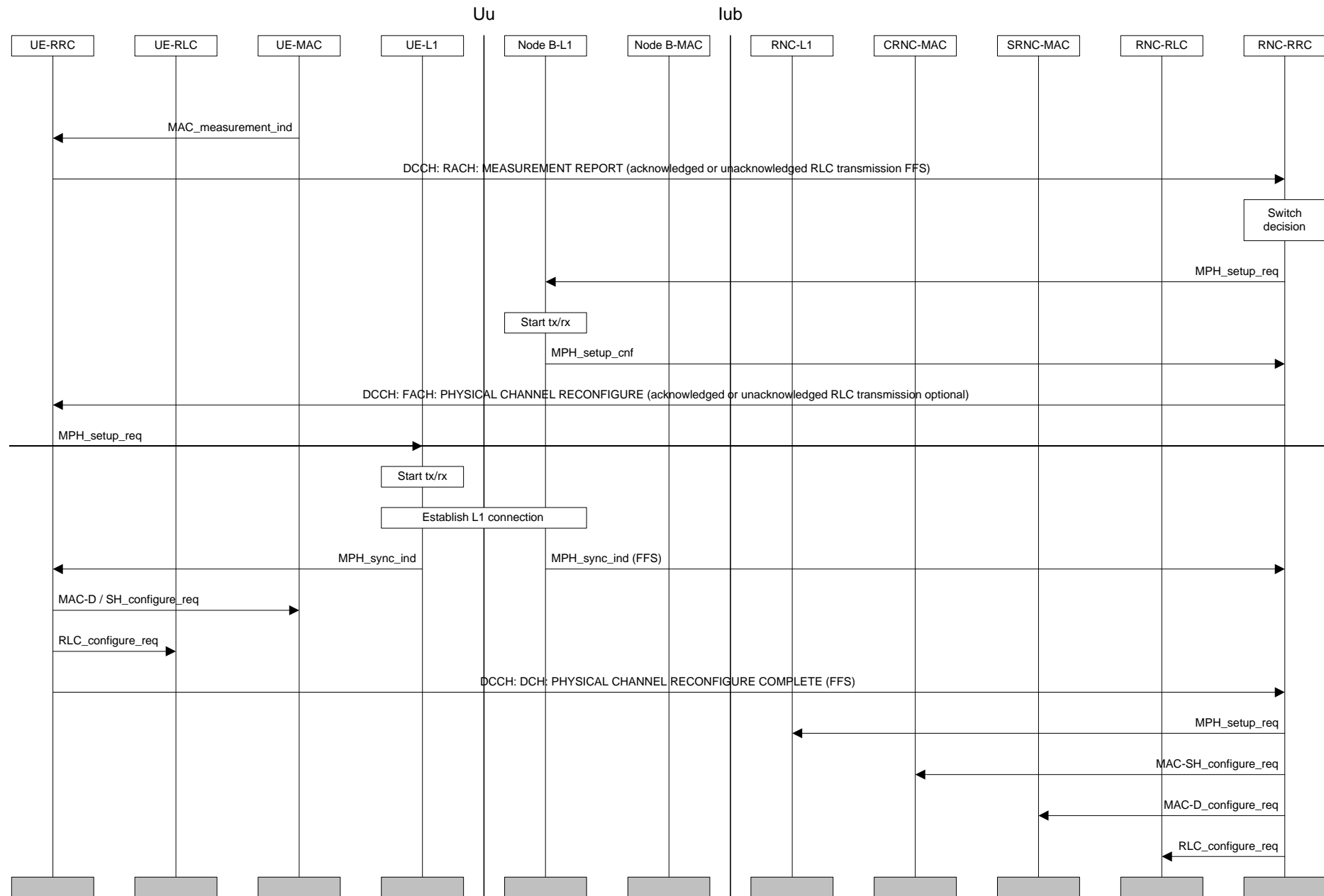



**Figure 19: UE-Originated DCH Activation**

Figure 19 illustrates an example of a procedure for a switch from common channels (RACH/FACH) to dedicated (DCH) channels.

In the UE the traffic volume measurement function decides to send a MEASUREMENT REPORT message to the network. In the network this measurement report could trigger numerous different actions. For example the network could do a change of transport format set, channel type switching or, if the system traffic is high, no action at all. In this case a switch from RACH/FACH to DCH/DCH is initiated.

Whether the report should be sent with acknowledged or unacknowledged data transfer or if the network should be able to configure data transfer mode for the report is FFS.

First, the modifications on L1 are requested and confirmed on the network side with CPHYMPH\_RL-S-setup primitives.

The RRC layer on the network side sends a PHYSICAL CHANNEL RECONFIGURE message to its peer entity in the UE (acknowledged or unacknowledged transmission optional to the network). This message is sent on DCCH mapped to FACH. The message includes information about the new physical channel, such as codes and the period of time for which the DCH is activated. *[Note1: This message does not include new transport formats. If a change of these is required due to the change of transport channel, this is done with the separate procedure Transport Channel Reconfiguration. This procedure only handles the change of transport channel.]*

When the UE has detected synchronisation on the new dedicated channel L2 is configured on the UE side and a PHYSICAL CHANNEL RECONFIGURE COMPLETE message can be sent on DCCH mapped on DCH to RRC in the network (need FFS). Depending on whether the complete-message is applied, the need for an indication of the synchronisation on the NW side is also FFS. Triggered by either the NW CPHYMPH\_sync\_ind or the L3 complete message, the RNC-L1 and L2 configuration changes are executed in the NW.

When applying the FAUSCH, the “DCCH: RACH: MEASUREMENT REPORT” is replaced by a “DCCH: FAUSCH: DCH REQUEST” message that is transmitted on the FAUSCH in unacknowledged mode. In this case rather than giving a measurement report for the NW to process, the FAUSCH indicates a request for a DCH of predefined capacity.

UE-terminated synchronised DCH Modify

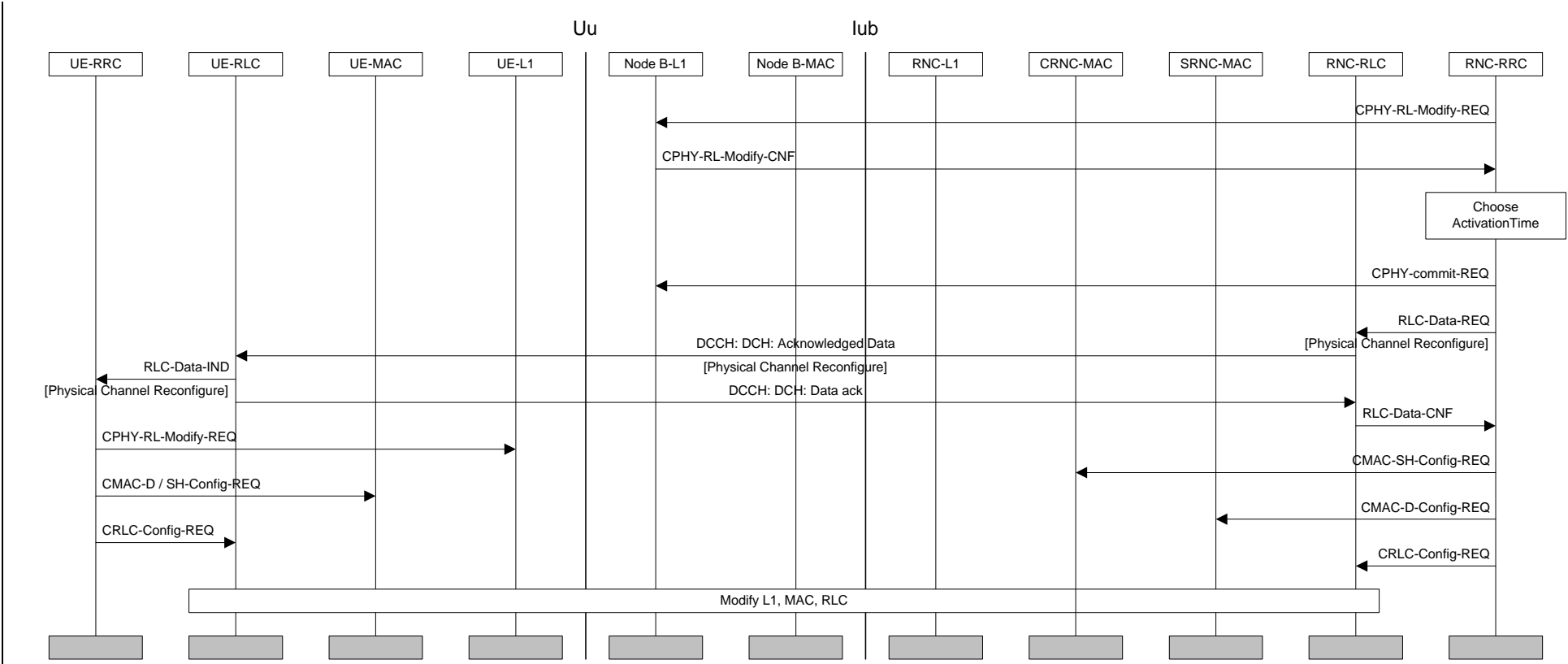

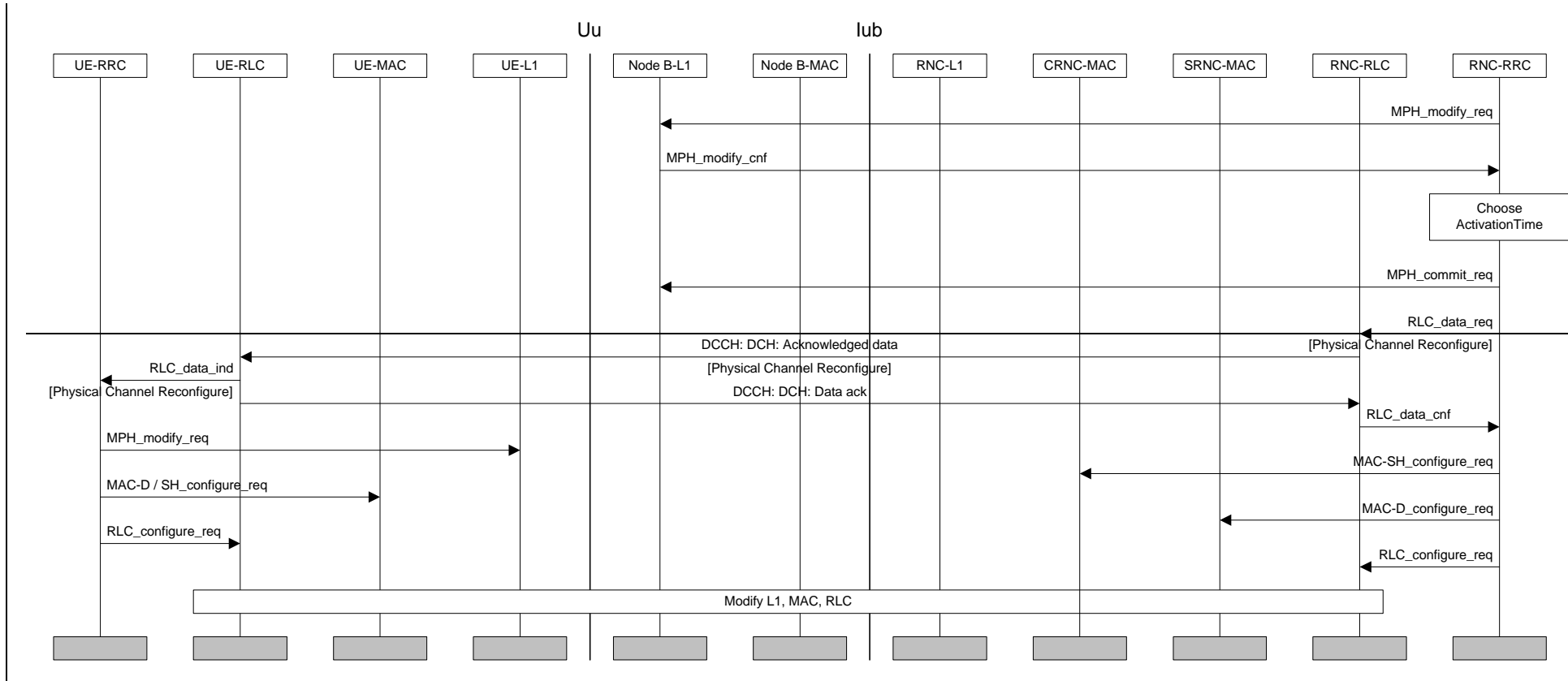

Figure 20: UE-terminated synchronised DCH Modify

Figure 20 illustrates an example of a synchronised procedure for DCH modification. Triggering of this procedure could for example be accomplished by an inactivity timer. The procedure can e.g. release all transport formats of a radio access bearer without releasing the DCH, due to another bearer using it. The synchronised procedure is applied in the case when the old and new configurations are not compatible e.g. change of channelization code.

After the CPHYMPH-RL-M—modify requests have been confirmed, an activation time is chosen by NW-RRC. After deciding upon the activation time, the NW-RRC sends a PHYSICAL CHANNEL RECONFIGURE message as acknowledged data transfer to the UE. In both uplink and downlink this message is sent on DCCH mapped on DCH.

After reception the UE reconfigures L1 and L2 to DCH resources. The need for a Physical Channel Reconfigure Complete message to the network is FFS (not shown here). If a complete message is used it would be sent on DCCH mapped on DCH. In the unsynchronised case this message could trigger a modification of L1 and L2 resources in the network associated with the dedicated channel.

## UE-terminated DCH Release

Figure 21 illustrates an example of a procedure for a switch from dedicated (DCH) to common (RACH/FACH) channels. All DCHs used by a UE are released and all dedicated logical channels are transferred to RACH/FACH instead. Triggering of this procedure could for example be an inactivity timer.

A switch from DCH to common channels is decided and a PHYSICAL CHANNEL RECONFIGURE message is sent (acknowledged or unacknowledged data transfer is a network option) from the RRC layer in the network to the UE. This message is sent on DCCH mapped on DCH. *[Note1: This message does not include new transport formats. If a change of these is required due to the change of transport channel, this is done with the separate procedure Transport Channel Reconfiguration. This procedure only handles the change of transport channel.]*

*[Note2: If the loss of L1 sync is used to detect in the NW that the UE has released the DCH:s, as is one possibility in the figure, then there may be a need to configure the Node B-L1 to a short timeout for detecting loss of sync. This is presented by the CPHYMPH\_out\_of\_sync\_configure primitives in the figure. The L23 group is seeking guidance from the L1-group relating to the time required for reliable out-of-sync detection. ]*

After reception the UE reconfigures L1 and L2 to release old DCH resources. The PHYSICAL CHANNEL RECONFIGURE COMPLETE (need FFS) message to the network is here sent on DCCH mapped on RACH (message acknowledgement on FACH). This message triggers a normal release of L1 and L2 resources in the network associated with the dedicated channel. If the L3 COMPLETE message doesn't exist, the CPHYMPH\_out\_of\_sync\_ind from the physical layer must be applied.

*[Note3: When a Switch to RACH/FACH is done it is important to free the old code as fast as possible so that it can be reused. Therefore instead of waiting for the Physical Channel Reconfigure Complete message the network can reconfigure L1 and L2 when the acknowledged data confirmation arrives and the network is sure that the UE has received the Physical Channel Reconfigure message. To be even more certain that the UE has released the old DCH resources the network can wait until after the Out of sync Indication from L1.*

*These steps including a timer starting when the Physical Channel Reconfigure is sent, gives the network four different indications that the released DCH is really released, and that resources can be reused.]*

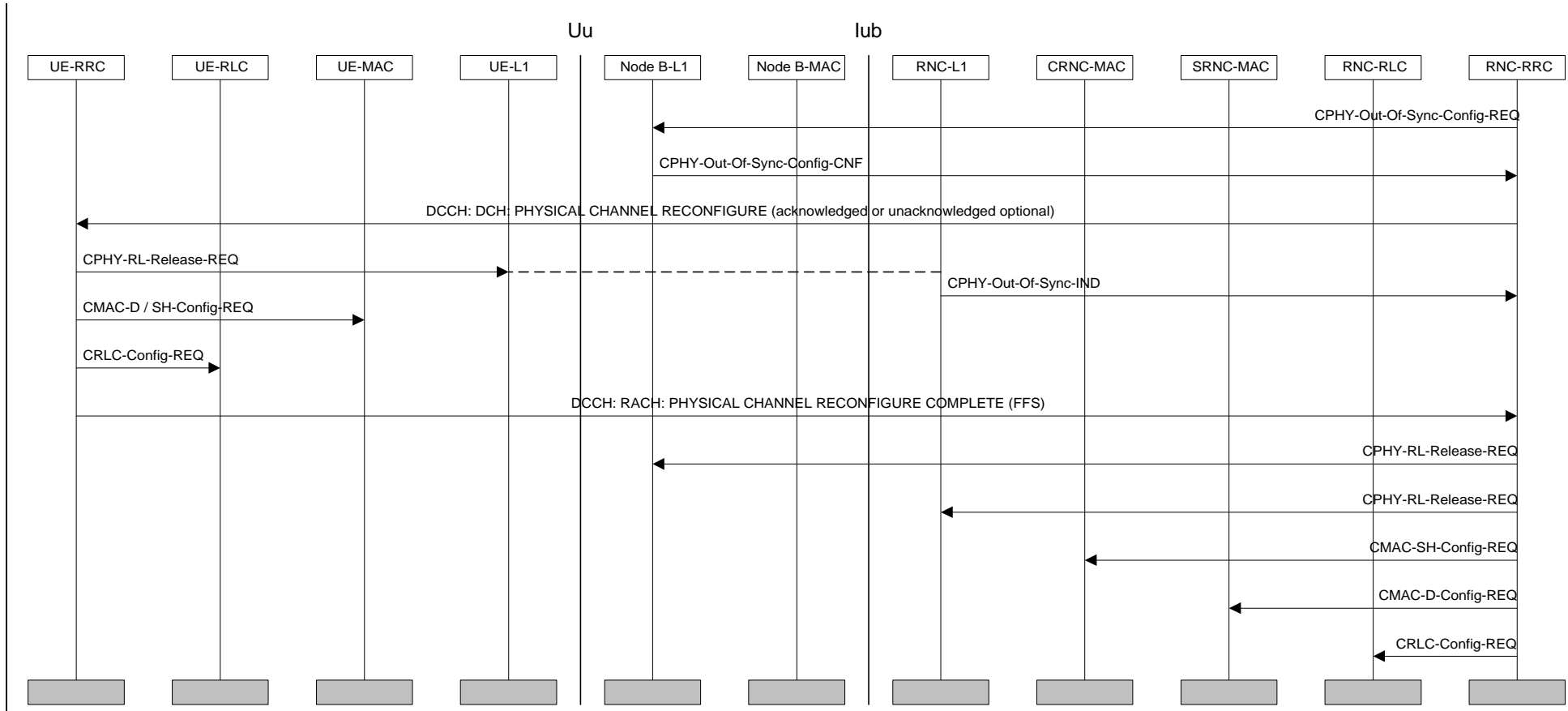

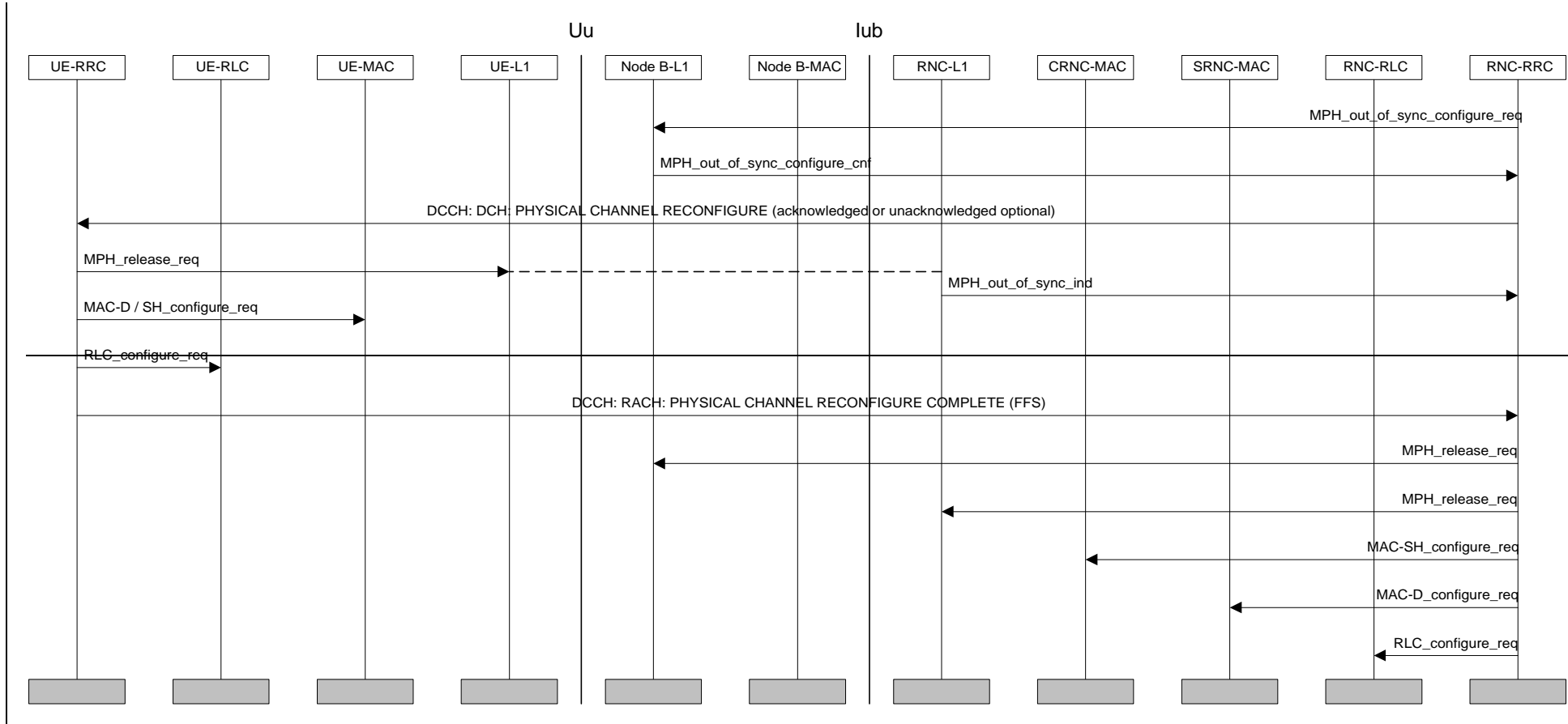
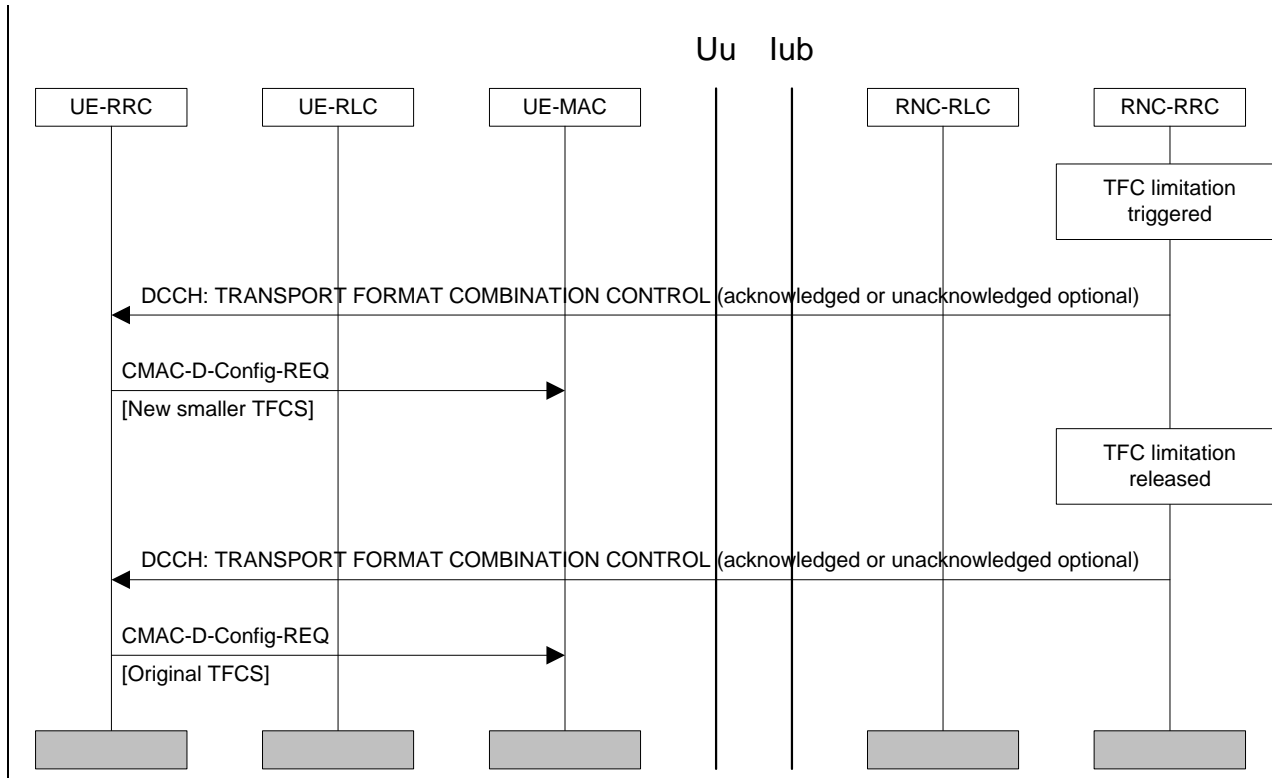

Figure 21: UE-terminated DCH Release

## Transport Format Combination Control

### Transport Format Combination Limitation





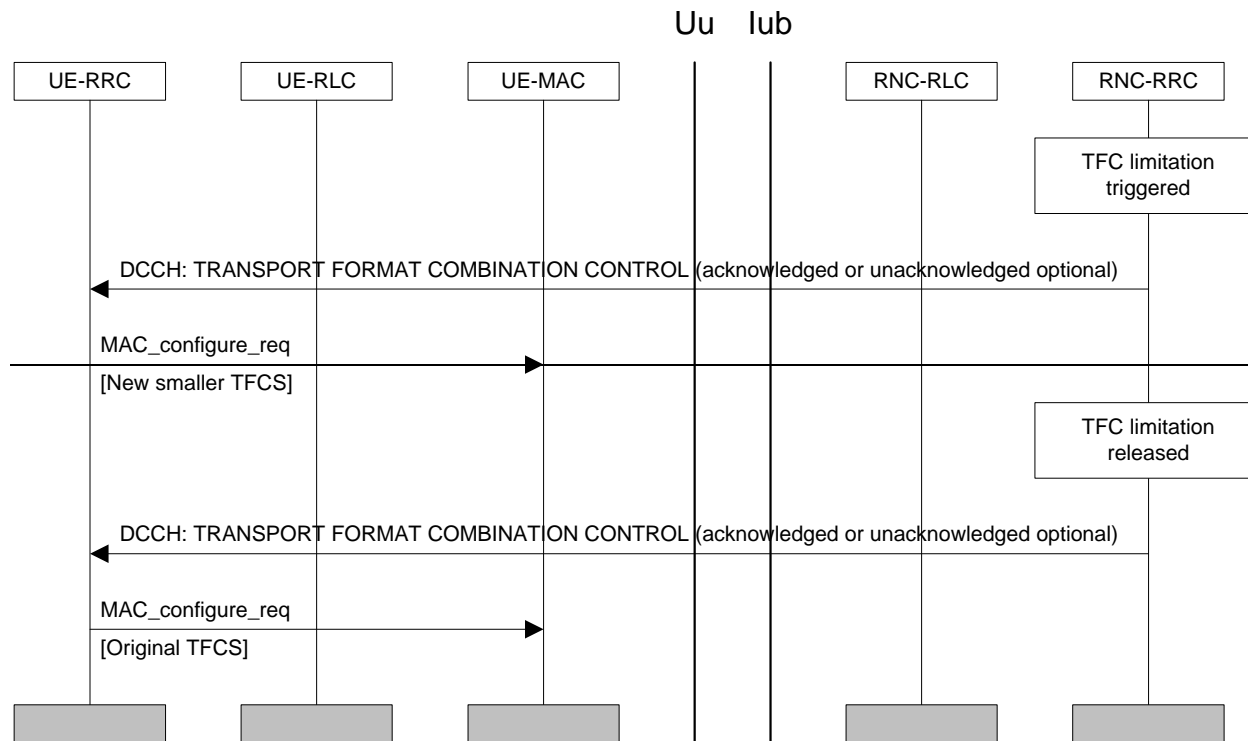

**Figure 22: Transport Format Combination Limitation**

Figure 22 illustrates an example of a Transport Format Combination Control procedure. A congestion situation occurs and allowed transport format combinations are restricted temporarily. When the congestion is resolved the restriction is removed.

This procedure is initiated with a Transport Format Combination Control message from the network to the UE (acknowledged or unacknowledged transmission optional to the NW). This message contains a subset of the ordinary Transport Format Combination Set. The UE then continues with a reconfiguration of MAC. MAC sees the TFC subset as a completely new set.

Further, after a while when the congestion is resolved a new Transport Format Combination Control message is sent to the UE from the RRC layer in the network. This message contains a subset that is the entire original set. Again, the UE reconfigures the MAC.

## RRC Connection mobility procedures

The RRC handover protocol must be common for the FDD and TDD modes. This means that the same protocol must support all the following handover procedures

## Handover Measurement Reporting

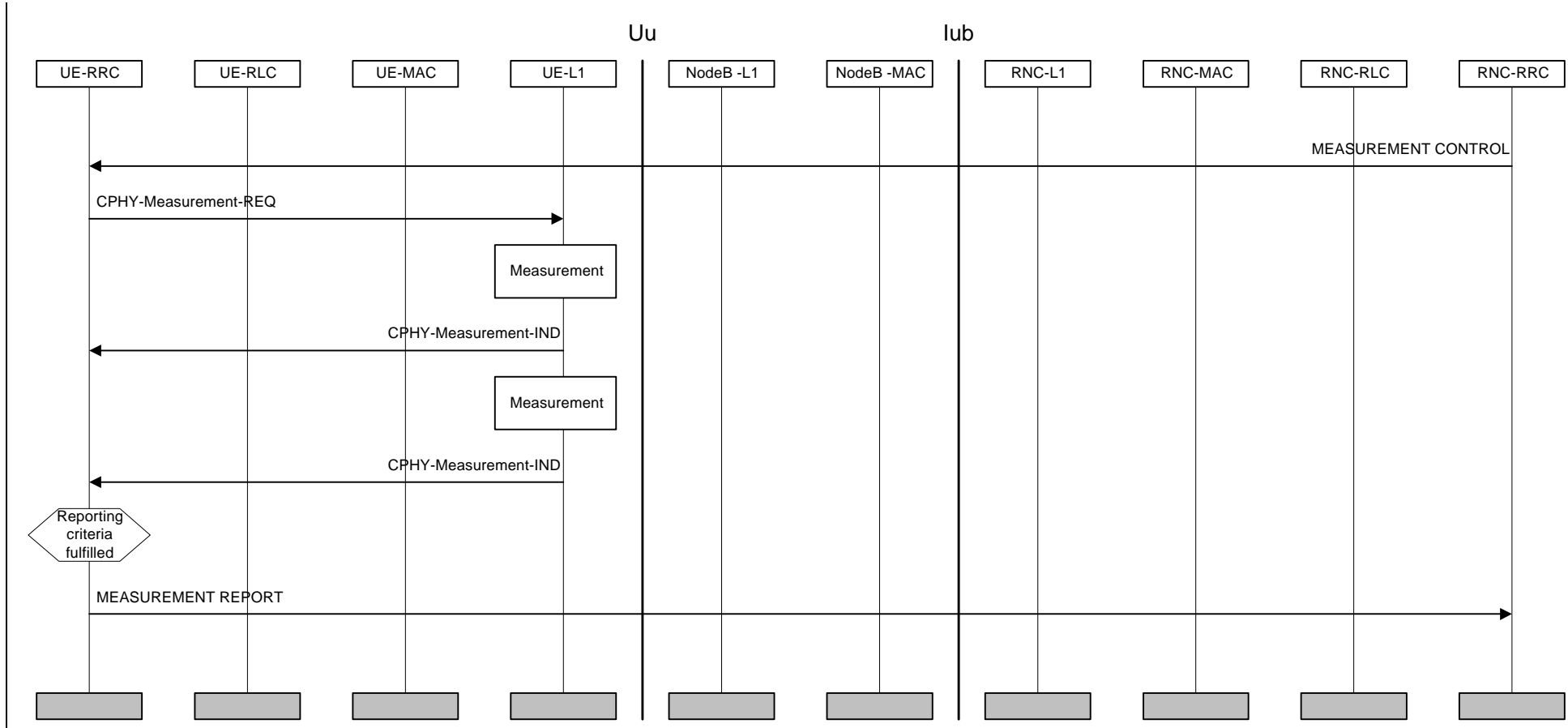

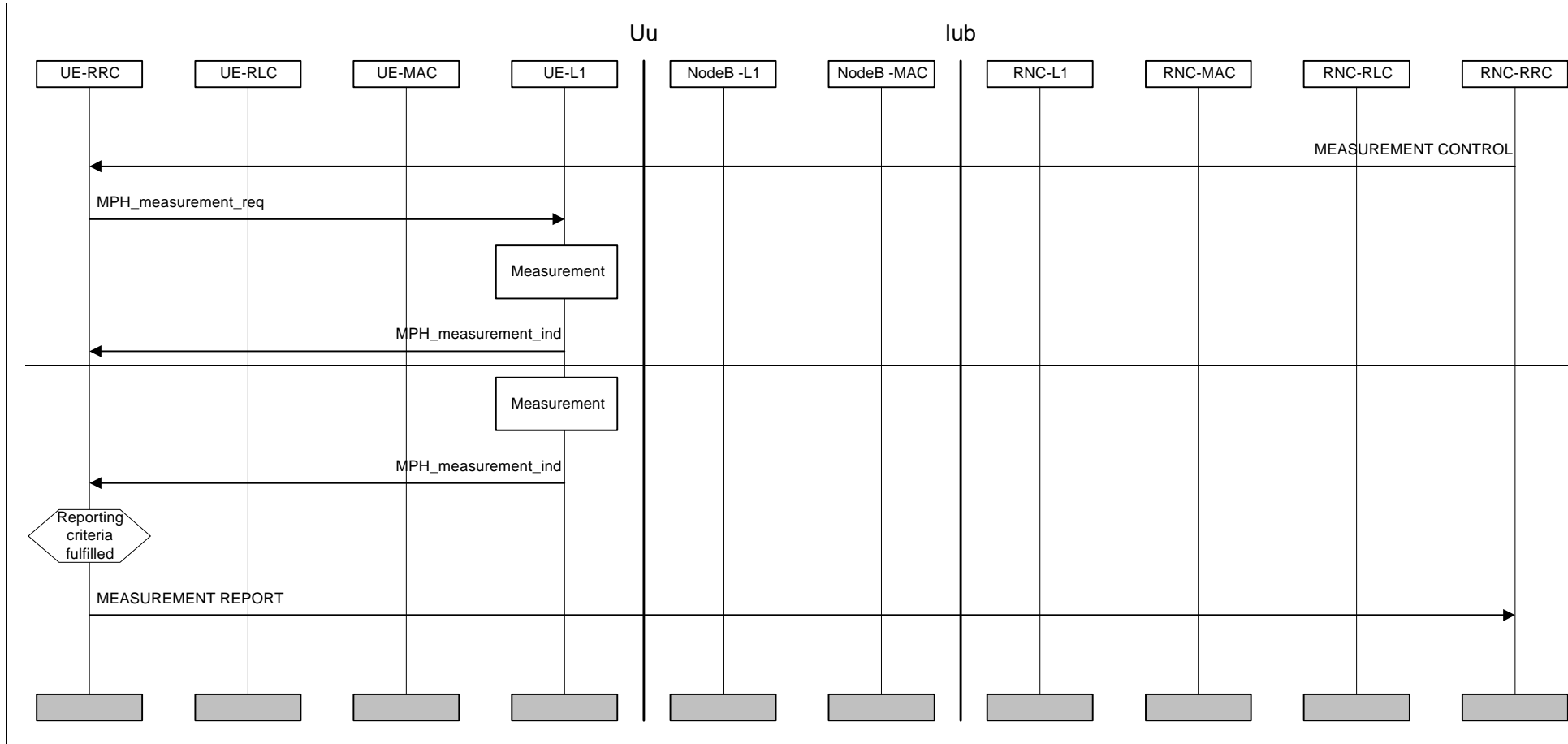

**Figure 23: Handover measurement reporting**

Figure 23 illustrates an example where a measurement control and a measurement report procedure is used for handover measurements. The NW RRC requests the UE to start measurements and reporting with a MEASUREMENT CONTROL message. The message includes an indication of a measurement type (e.g. intra-frequency measurement), the radio links to evaluate, the reporting criteria and a measurement identity number. The UE configures L1 to start measurements. When measurement reporting criteria are fulfilled the UE sends a MEASUREMENT REPORT message.

## Cell Update

[Note: This example currently applies only in the case of URA change.]

Figure 24 illustrates an example of a cell update procedure. The signalling is performed on the CCCH using transparent data transfer.

The cell update procedure is a forward handover procedure. It is triggered by the cell re-selection function in the UE, which notifies which cell the UE should switch to. The UE reads the broadcast information of the new cell. Subsequently, the UE RRC layer sends a CELL UPDATE REQUEST message to the UTRAN RRC via the MAC SAP for the CCCH logical channel and the RACH transport channel. The RACH transmission includes the current RNTI.

[Editor's Note: The logical channel to be used and the routing of the message are FFS, thus [Figure 24](#) only illustrates one possible approach.]

Upon reception of the CELL UPDATE REQUEST, the UTRAN registers the change of cell and replies with a CELL UPDATE CONFIRM message transmitted on the CCCH/FACH to the UE. The message includes the current RNTI and may also include a new RNTI.

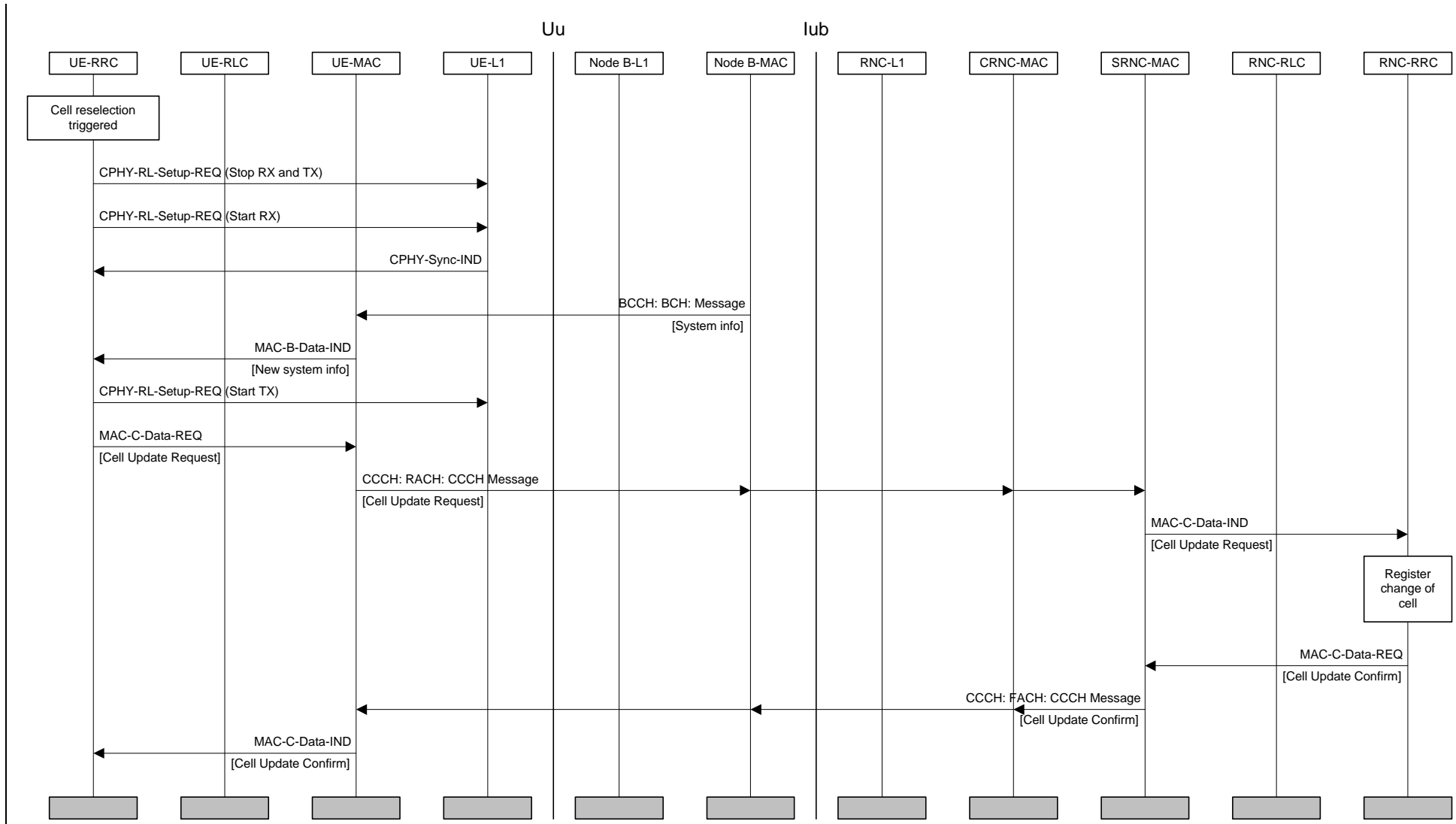



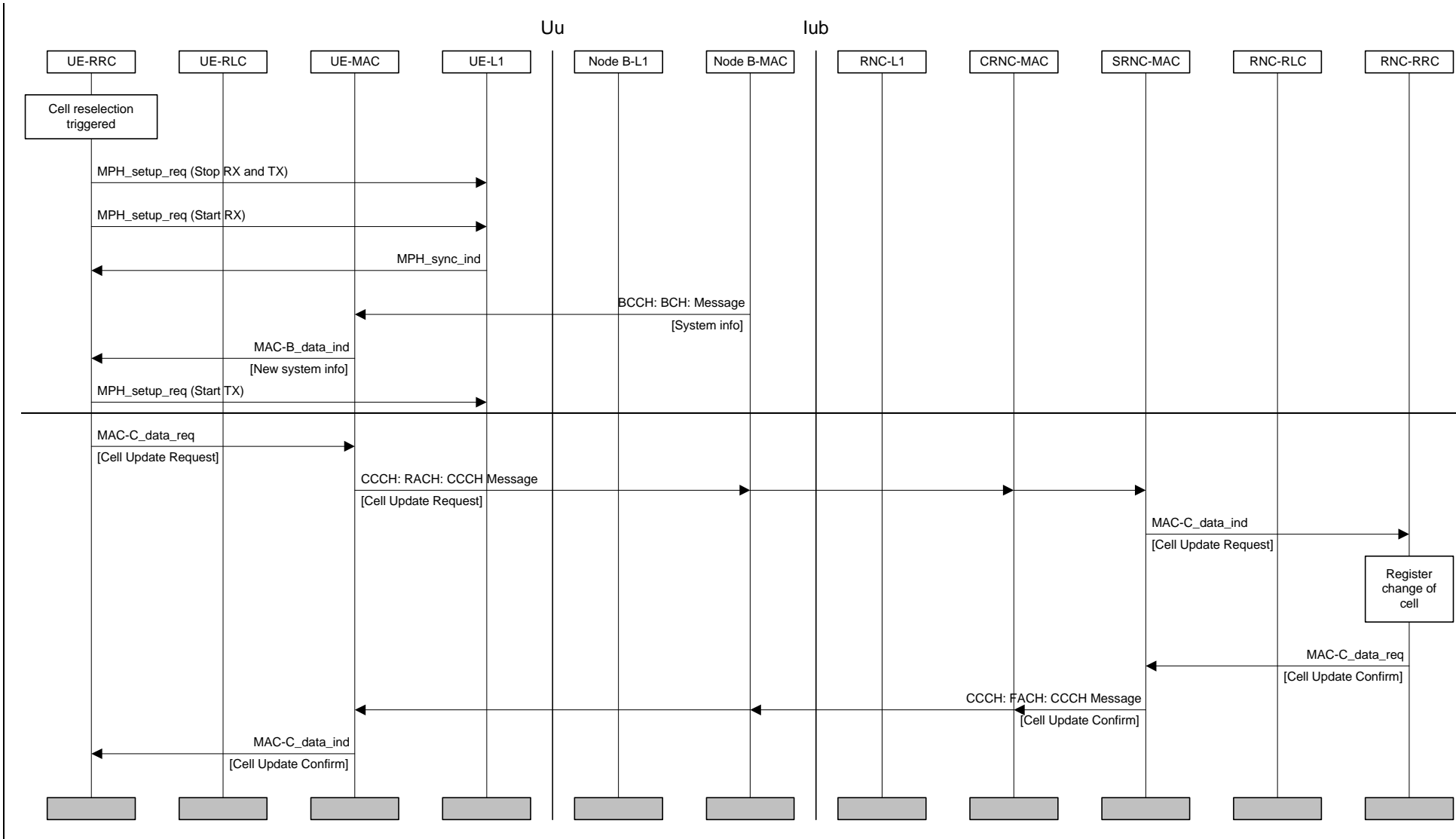

Figure 24: Cell update procedure

## URA Update

Figure 25 illustrates an example of a URA Update procedure. The signalling is performed on the CCCH.

When cell re-selection is triggered, the UE abandons the radio link in the old cell and establishes a radio link to the new cell. The URA update procedure is triggered when the UE reads the broadcast information of the new cell and recognises that a URA update is required. After that, the UE RRC layer sends a URA UPDATE REQUEST on the CCCH to the UE MAC layer, which transfers the message on the RACH to UTRAN. The RACH transmission includes the current RNTI.

[Editor's Note: The logical channel to be used and the routing of the message are FFS, thus [Figure 25](#) only illustrates one possible approach.]

Upon reception of the URA UPDATE REQUEST, the UTRAN registers the change of URA. Then the UTRAN RRC layer requests the UTRAN MAC layer to send a URA UPDATE CONFIRM message on the FACH to the UE. The message includes the current RNTI and may also include a new RNTI.

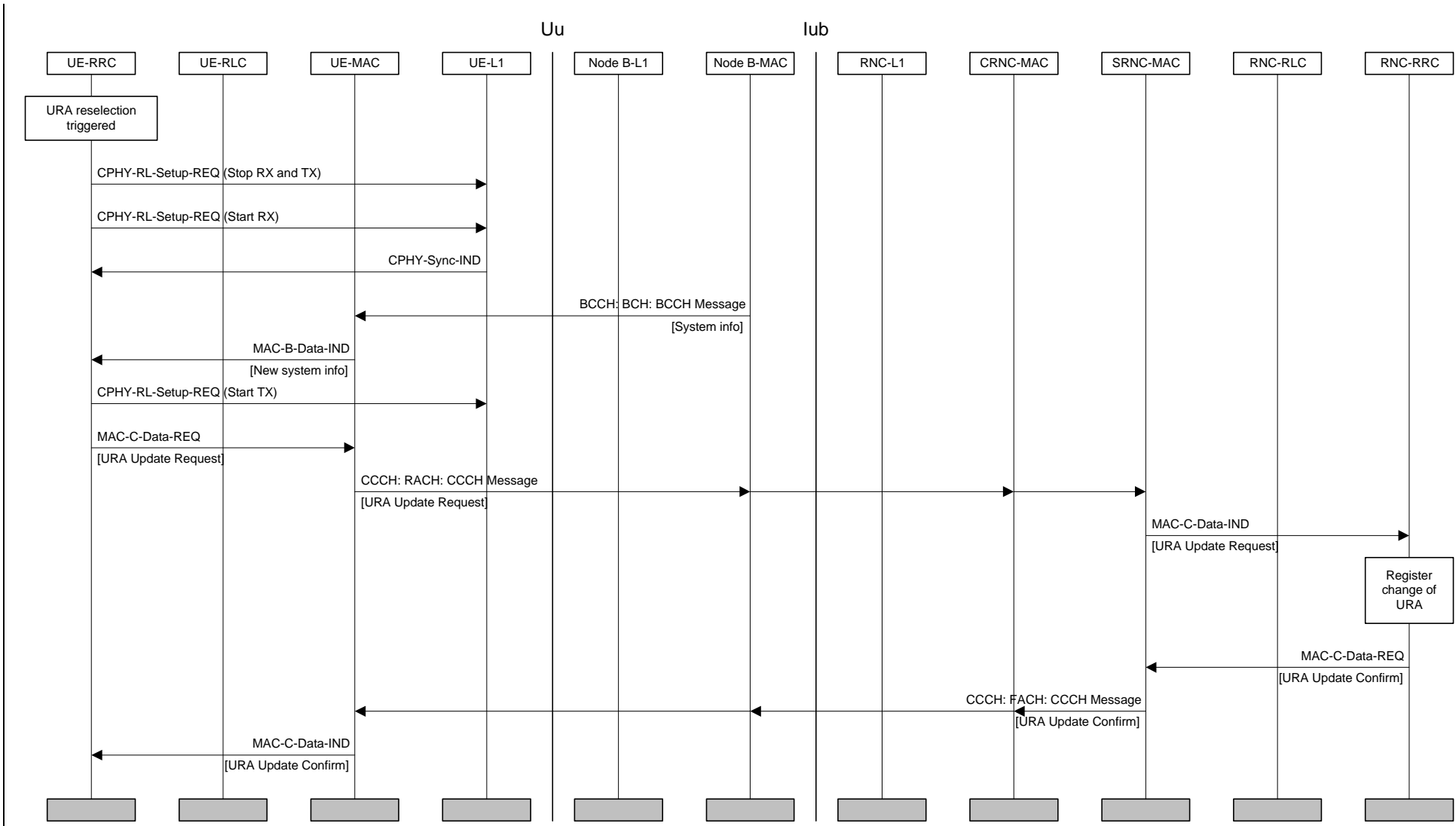

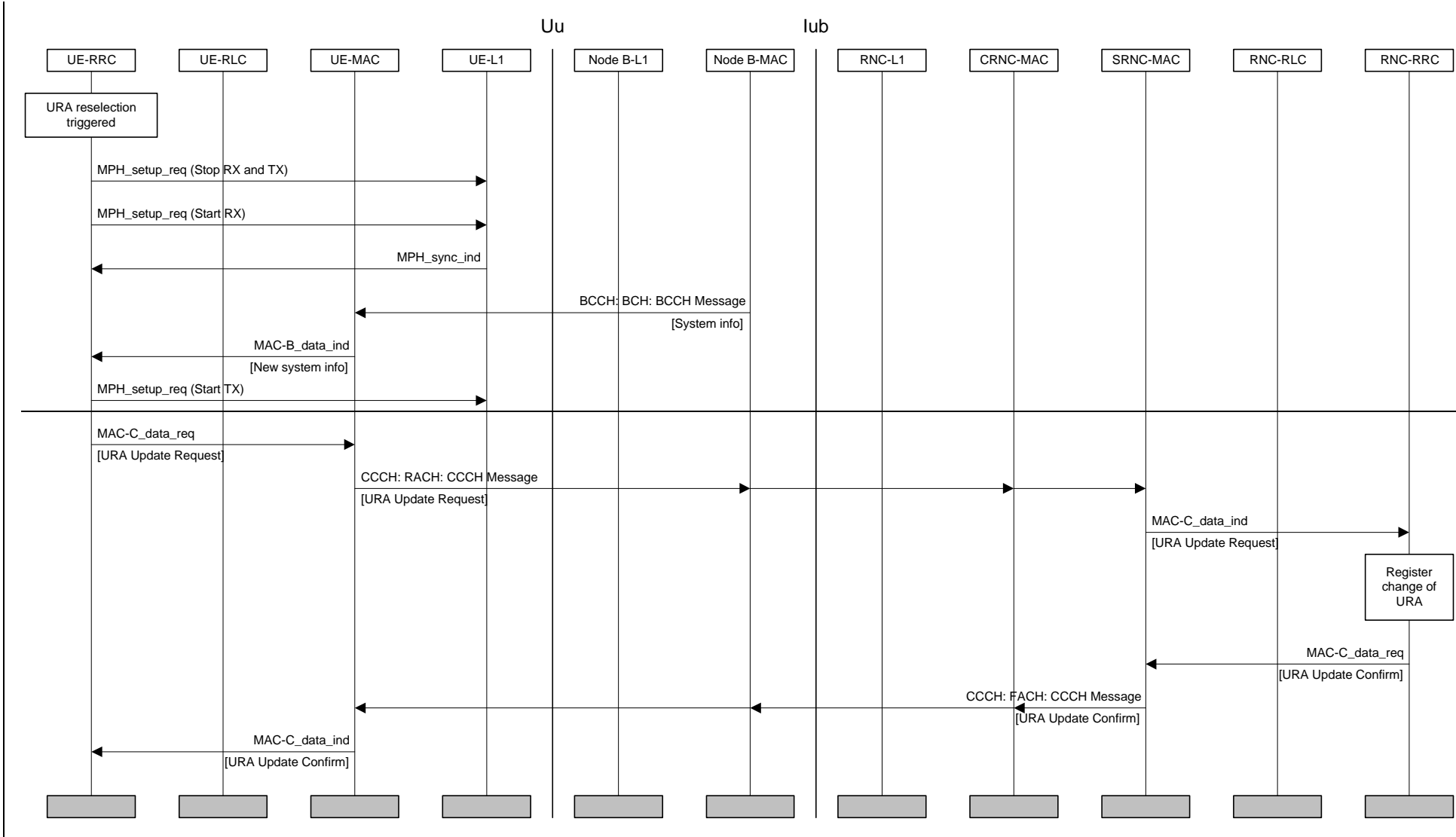
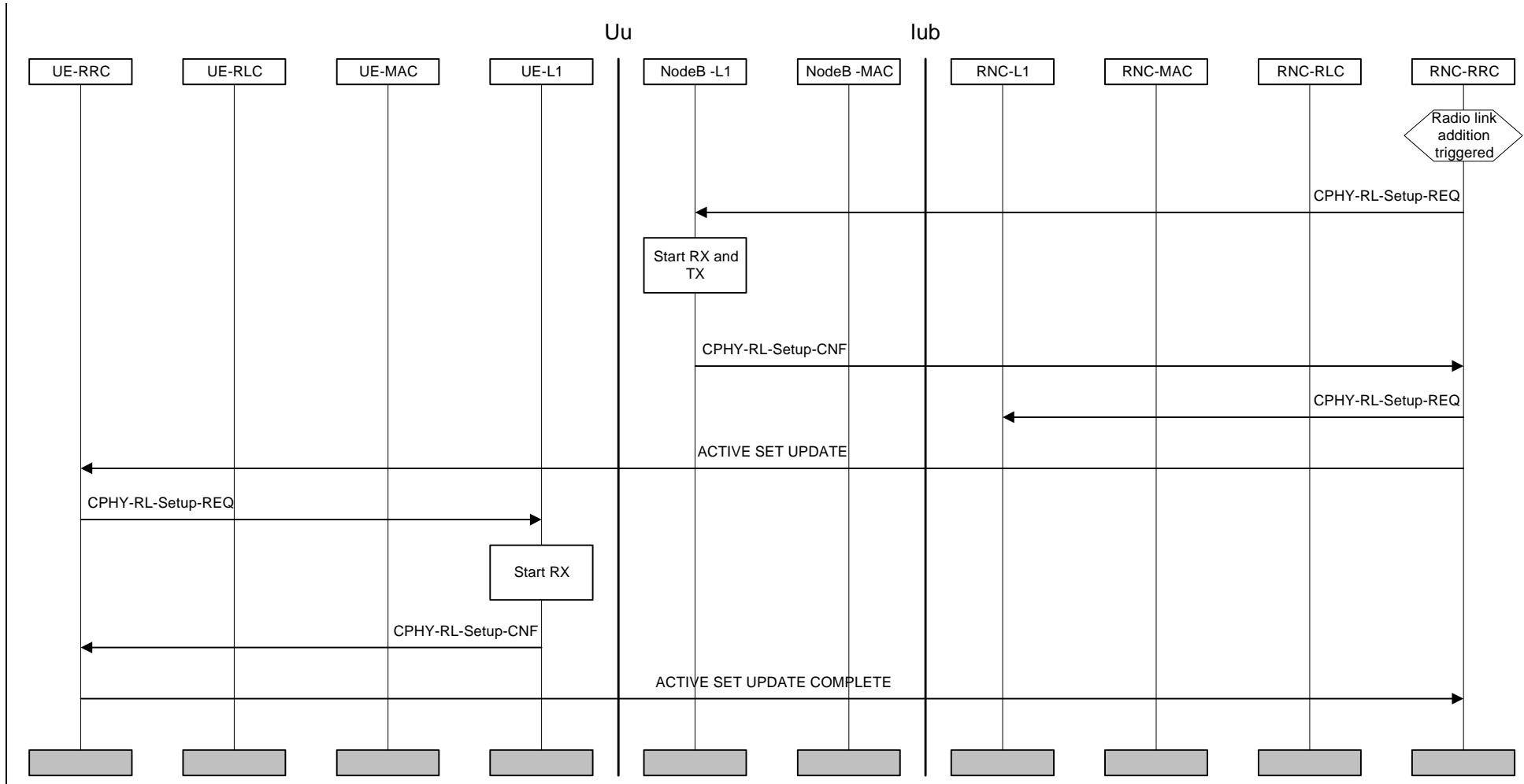
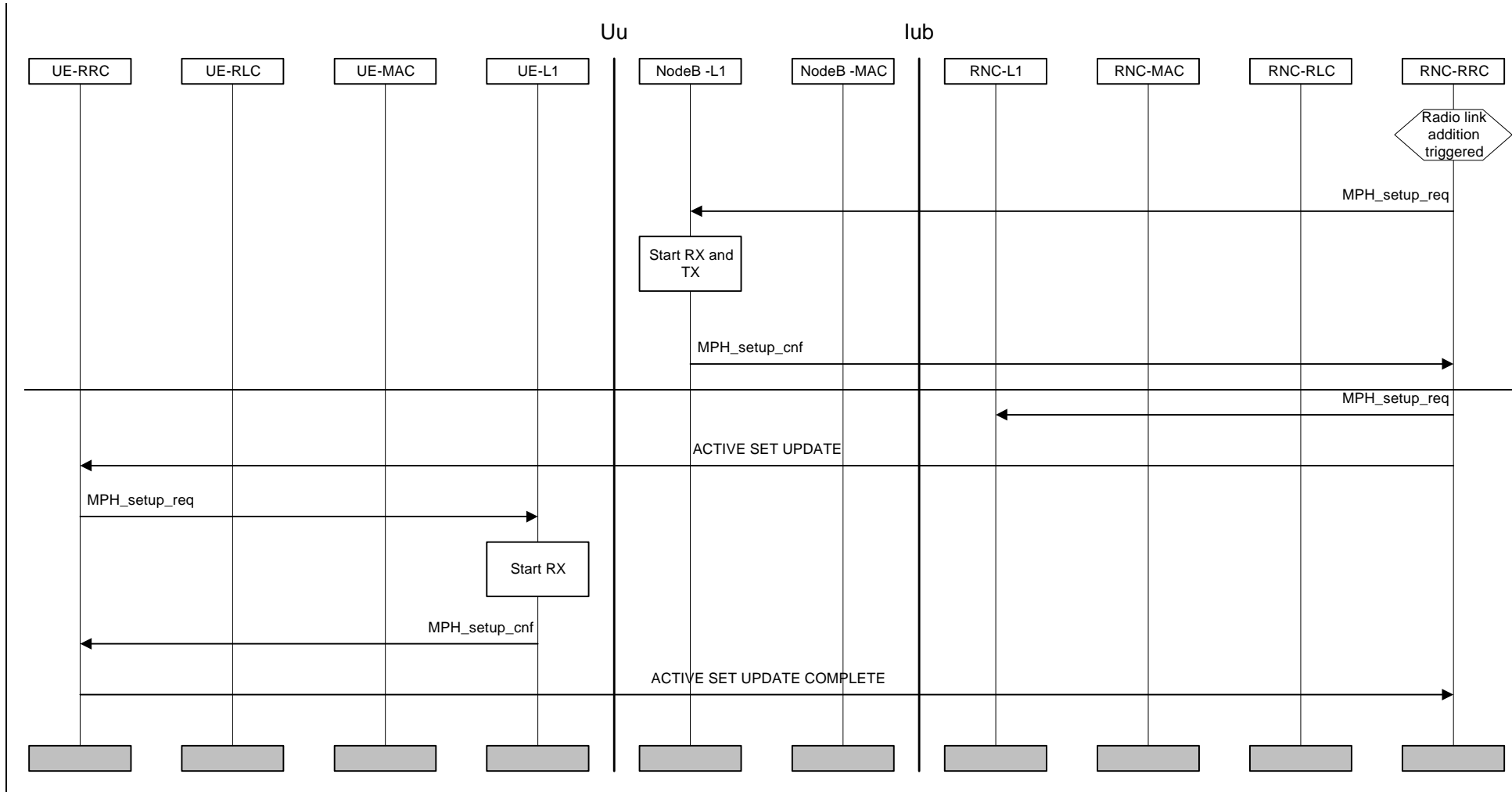

Figure 25: URA update procedure

## Radio Link Addition (FDD soft-add)

*[Note: TDD soft-add is an option supported on the condition that L1 supports it]*





**Figure 26: Radio Link Addition**

Figure 26 illustrates a radio link addition procedure. Radio link addition is triggered in the network RRC layer by measurement reports sent by the UE. The NW RRC first configures the new radio link on the physical layer in Node B. Transmission and reception begin immediately. The NW RRC then sends an RRC ACTIVE SET UPDATE message to the UE RRC. The UE RRC configures layer 1 to begin reception.

After confirmation from the physical layer in UE an ACTIVE SET UPDATE COMPLETE message is sent to the RNC-RRC.

## Radio Link Removal (FDD soft-drop)

*[Note: TDD soft-drop is an option supported on the condition that L1 supports it]*



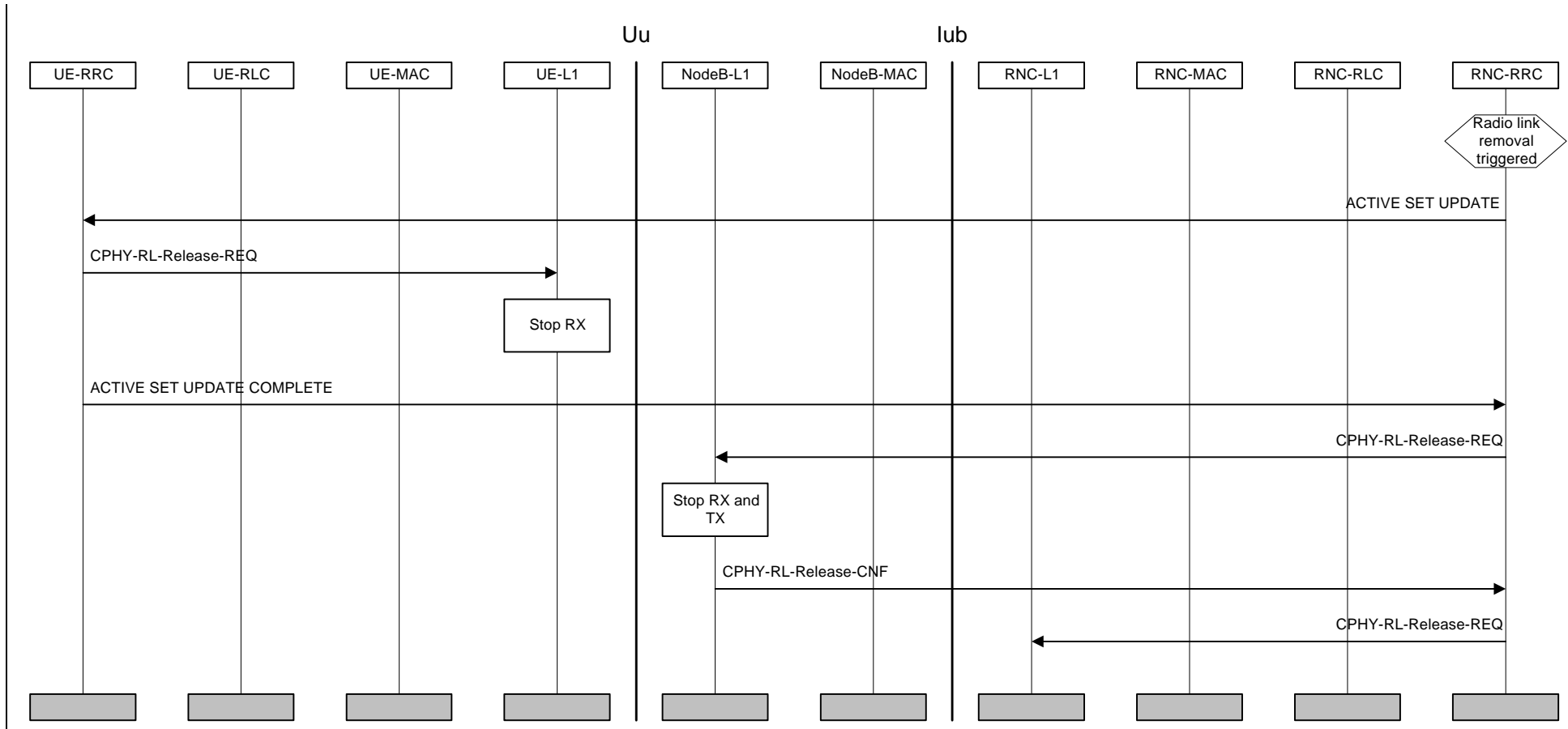

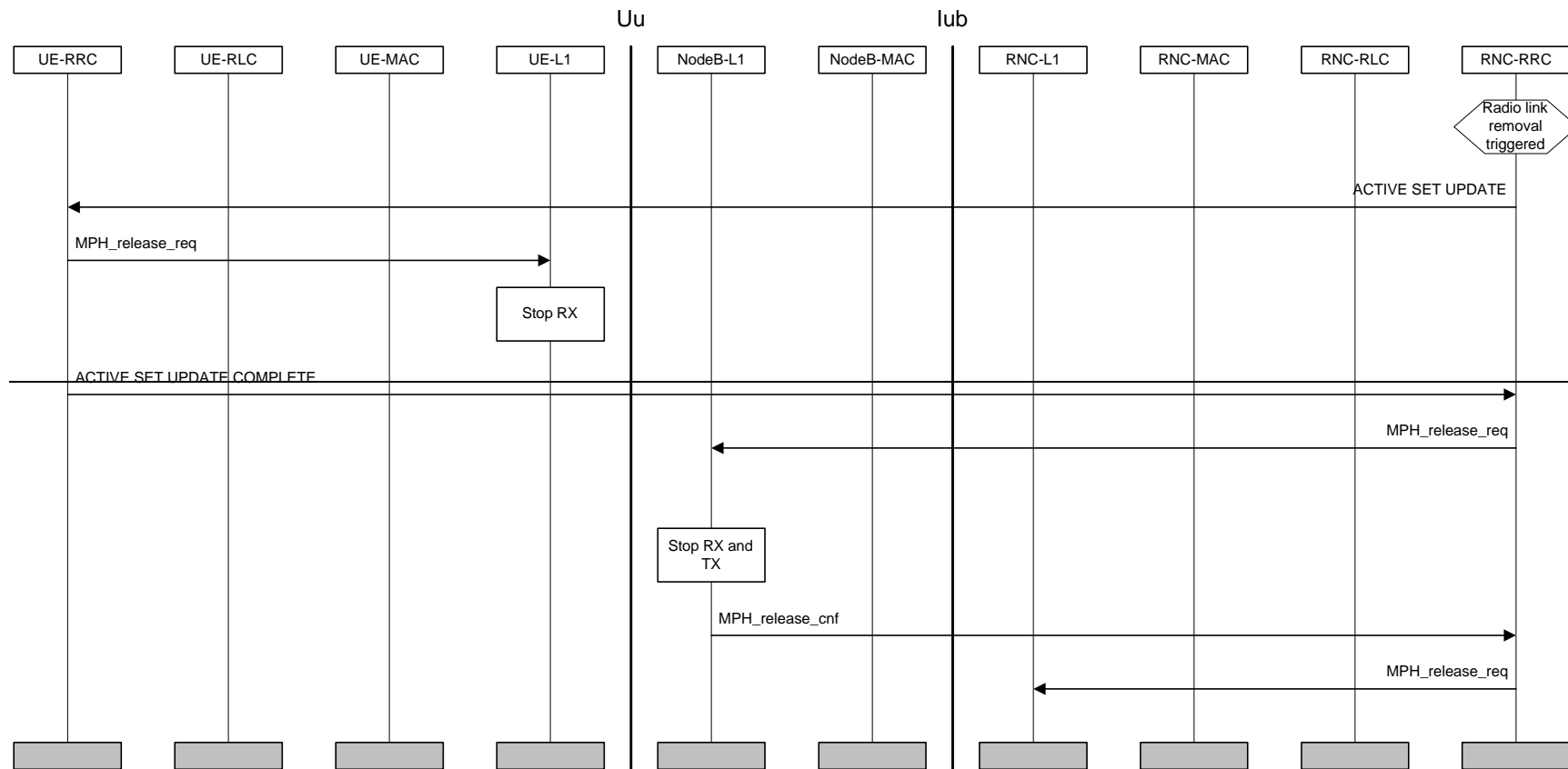
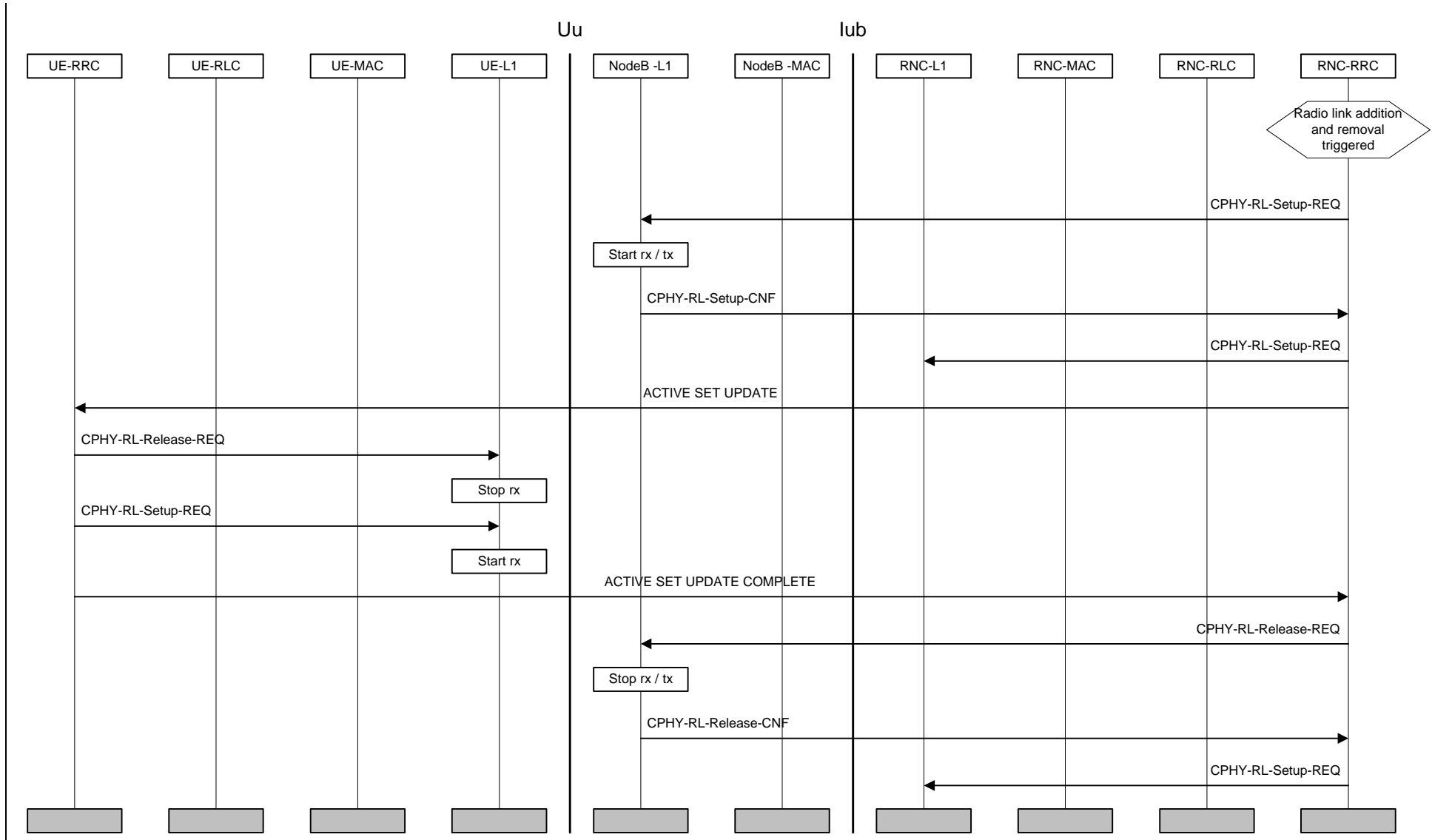

**Figure 27: Radio link removal**

Figure 27 illustrates a radio link removal procedure. Radio link removal is triggered by an algorithm in the network RRC layer by measurement reports sent by the UE. Radio link removal may also be triggered in the NW due to load control algorithms. The radio link is first deactivated by the UE and then in the NW.

The NW RRC sends an ACTIVE SET UPDATE message to the UE RRC. The UE RRC requests UE L1 to terminate reception of the radio link(s) to be removed. After this the UE RRC acknowledges radio link removal with an ACTIVE SET UPDATE COMPLETE message to the NW RRC. The NW RRC proceeds to request the NW L1 in both Node B and the RNC to release the radio link.

## Combined radio link addition and removal



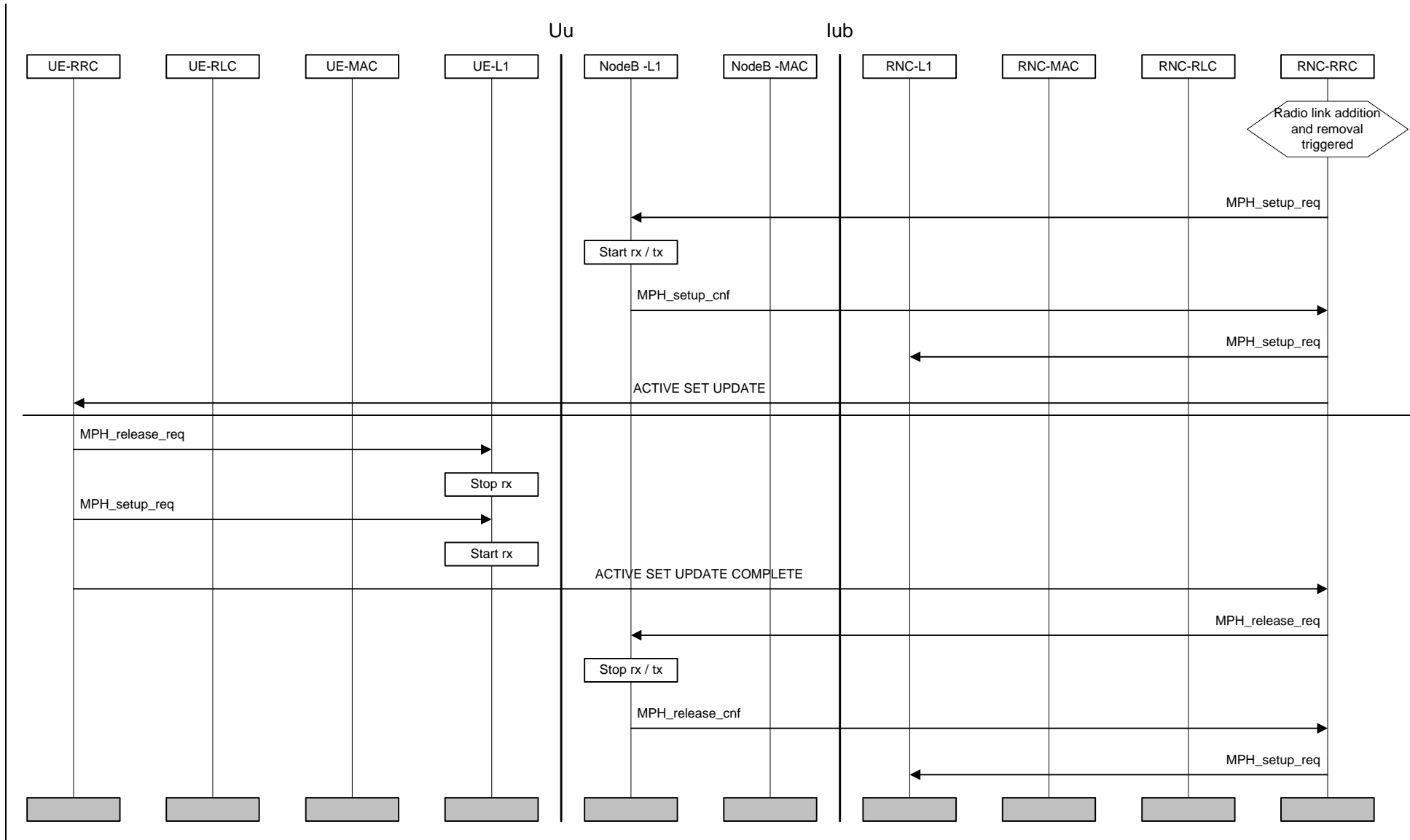

**Figure 28: Combined Radio Link Addition And Removal**

Figure 28 illustrates a combined radio link addition and removal procedure. The NW RRC determines the need for radio link replacement based on received measurement reports or load control algorithms.

When radio links are to be replaced, the NW RRC first configures the NW L1 to activate the radio link(s) that are being added. The NW RRC then sends an ACTIVE SET UPDATE message to the UE RRC, which configures the UE L1 to terminate reception on the removed radio link(s) and begin reception on the added radio link(s).

If the UE active set is full, the replacement has to be performed in the order defined in Figure 28. If UE has only one radio link, then the replacement must be done in reverse order (first add, then remove). *Note: The present assumption is that the order of the replacement can be left to the UE.*

The UE RRC acknowledges the replacement with an ACTIVE SET UPDATE COMPLETE message. The NW RRC then configures the NW L1 to terminate reception and transmission on the removed radio link.

## Hard Handover (FDD and TDD hard)

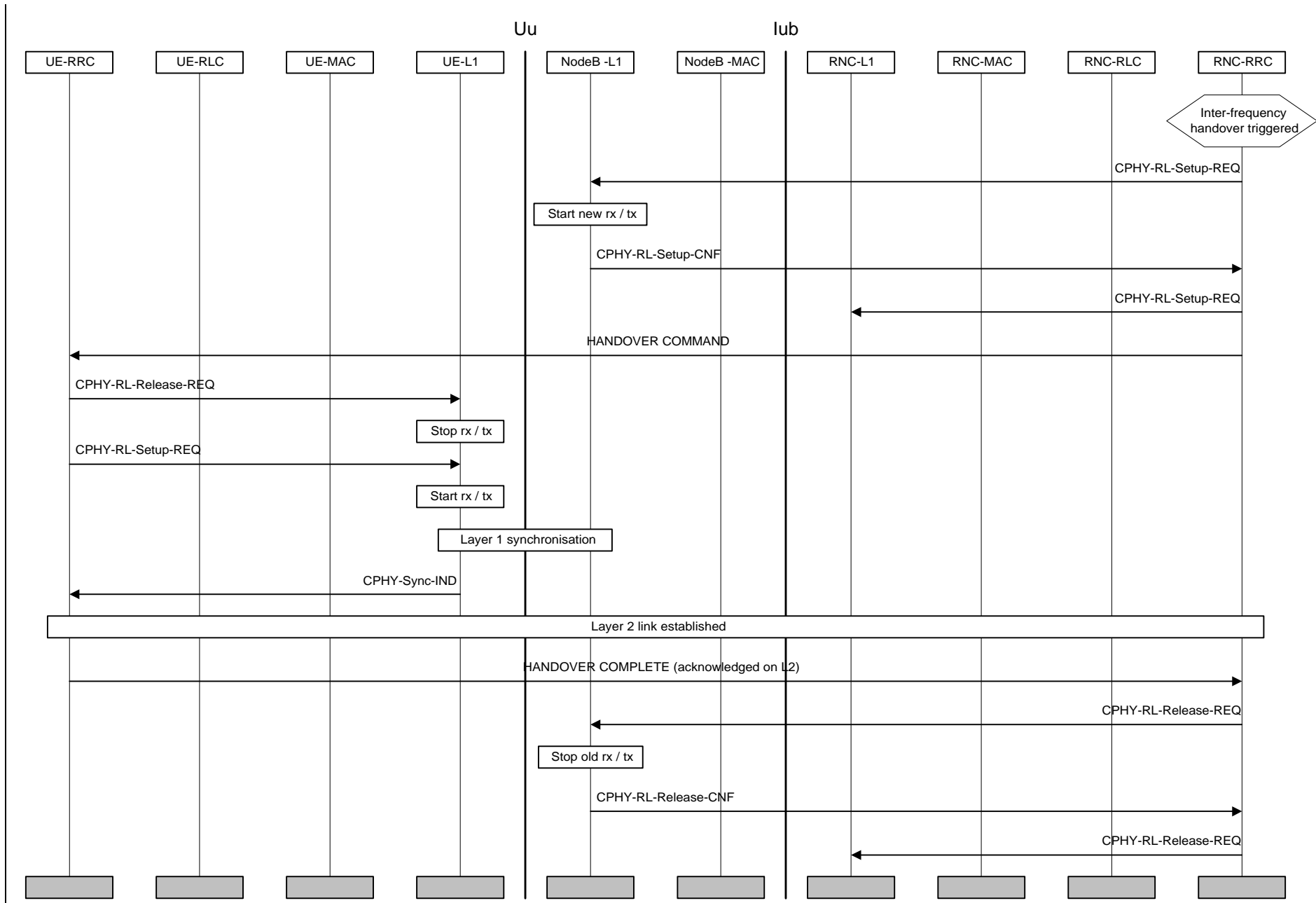



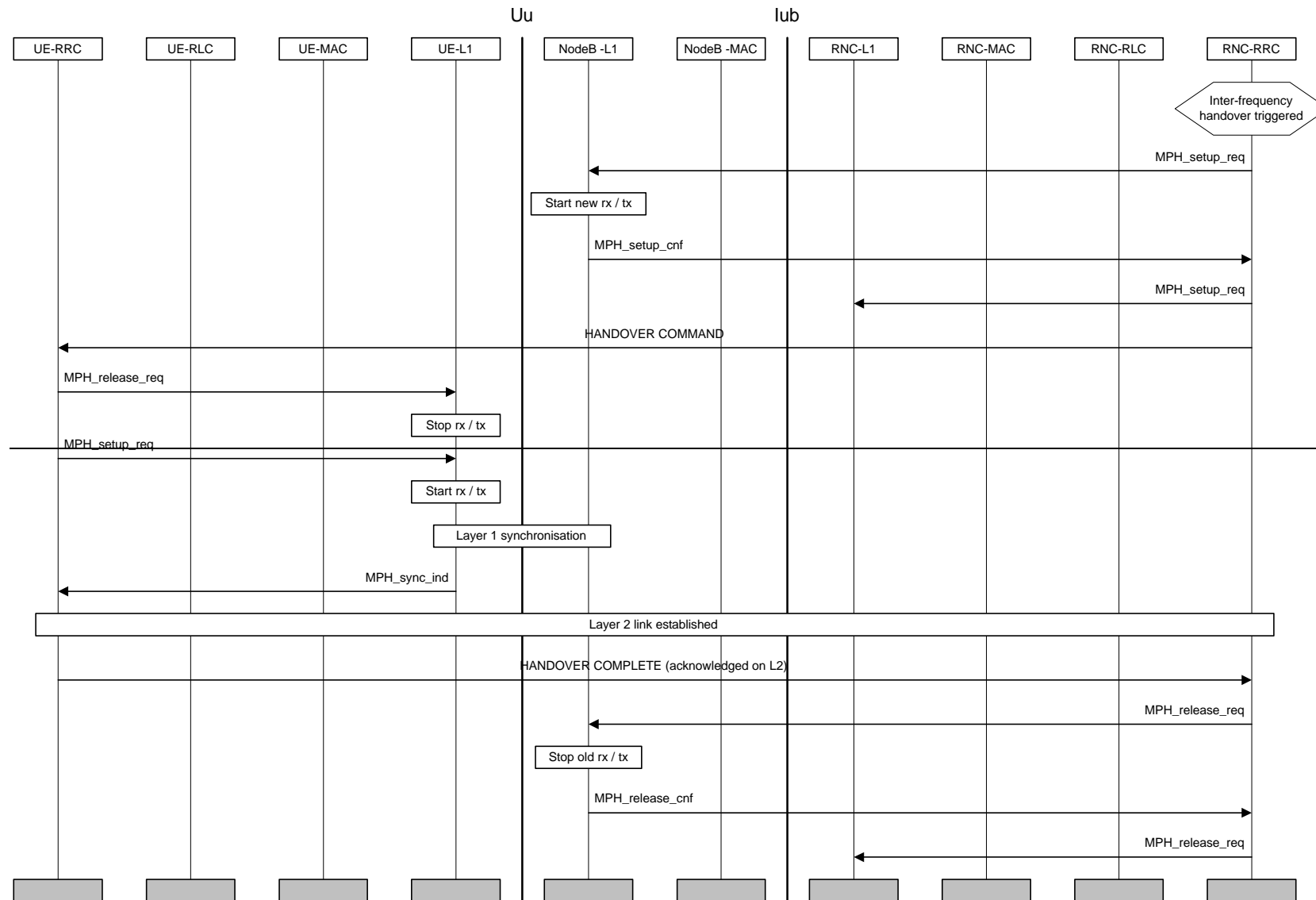

**Figure 29: Hard handover**

Figure 29 illustrates a hard handover. The NW RRC determines the need for hard handover based on received measurement reports or load control algorithms.

For inter-frequency handover the measurements are assumed to be performed in slotted mode.

The NW RRC first configures the NW L1 to activate the new radio links. The NW L1 begins transmission and reception on the new links immediately. The NW RRC then sends the UE RRC a HANDOVER COMMAND message. The message indicates the radio resources that should be used for the new radio link. The UE RRC configures the UE L1 to terminate reception on the old radio link and begin reception on the new radio link.

After the UE L1 has achieved downlink synchronisation on the new frequency, a L2 link is established and the UE RRC sends a HANDOVER COMPLETE message to the NW RRC. After having received the L3 acknowledgement, the NW RRC configures the NW L1 to terminate reception and transmission on the old radio link.

*[Note 1: Whether it should be possible to setup several radio links immediately on the new frequency is FFS.]*

*[Note 2: The suspension and resuming of the CC and MM signalling during handover is FFS.]*

## RRC Connection re-establishment

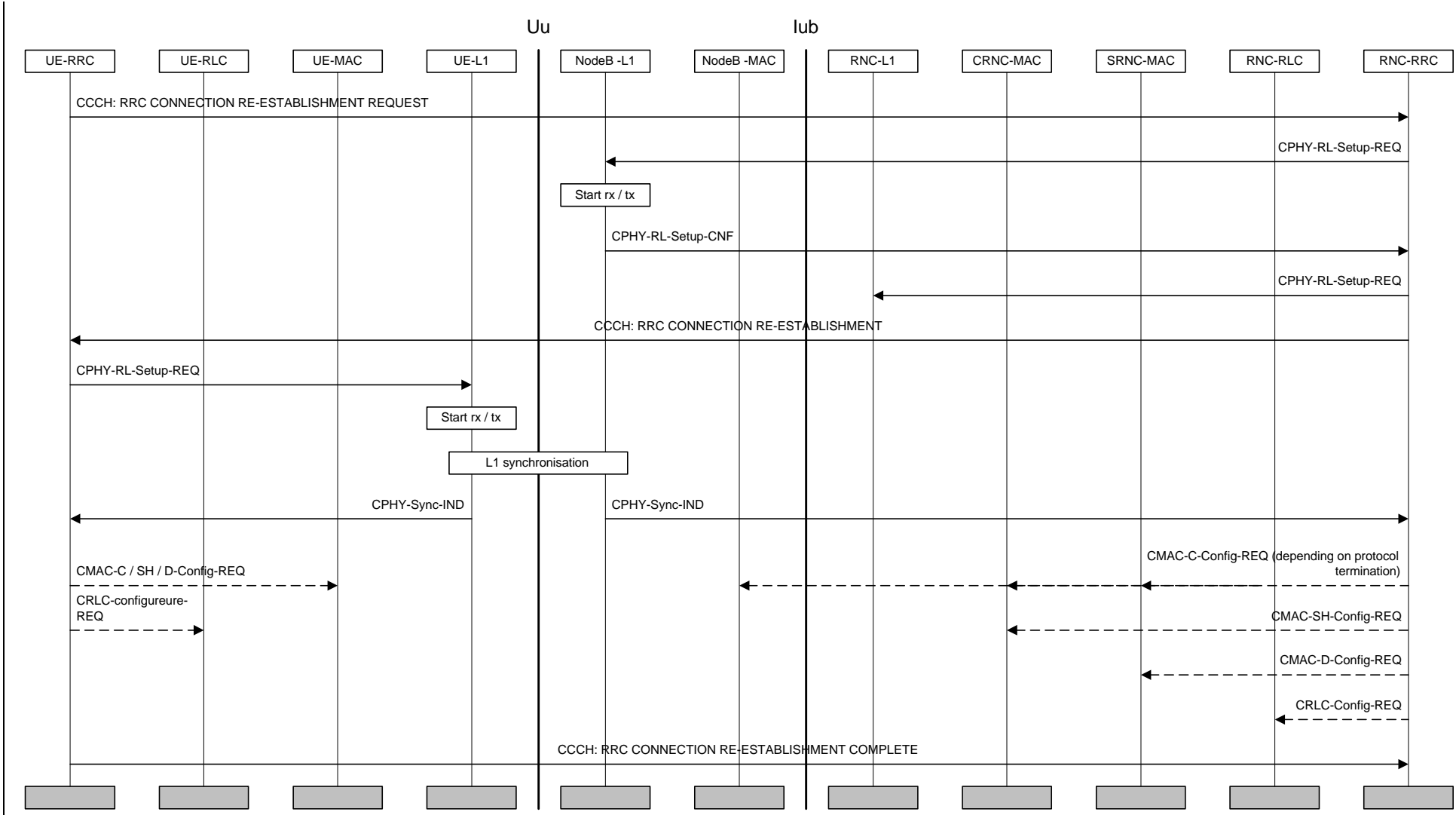

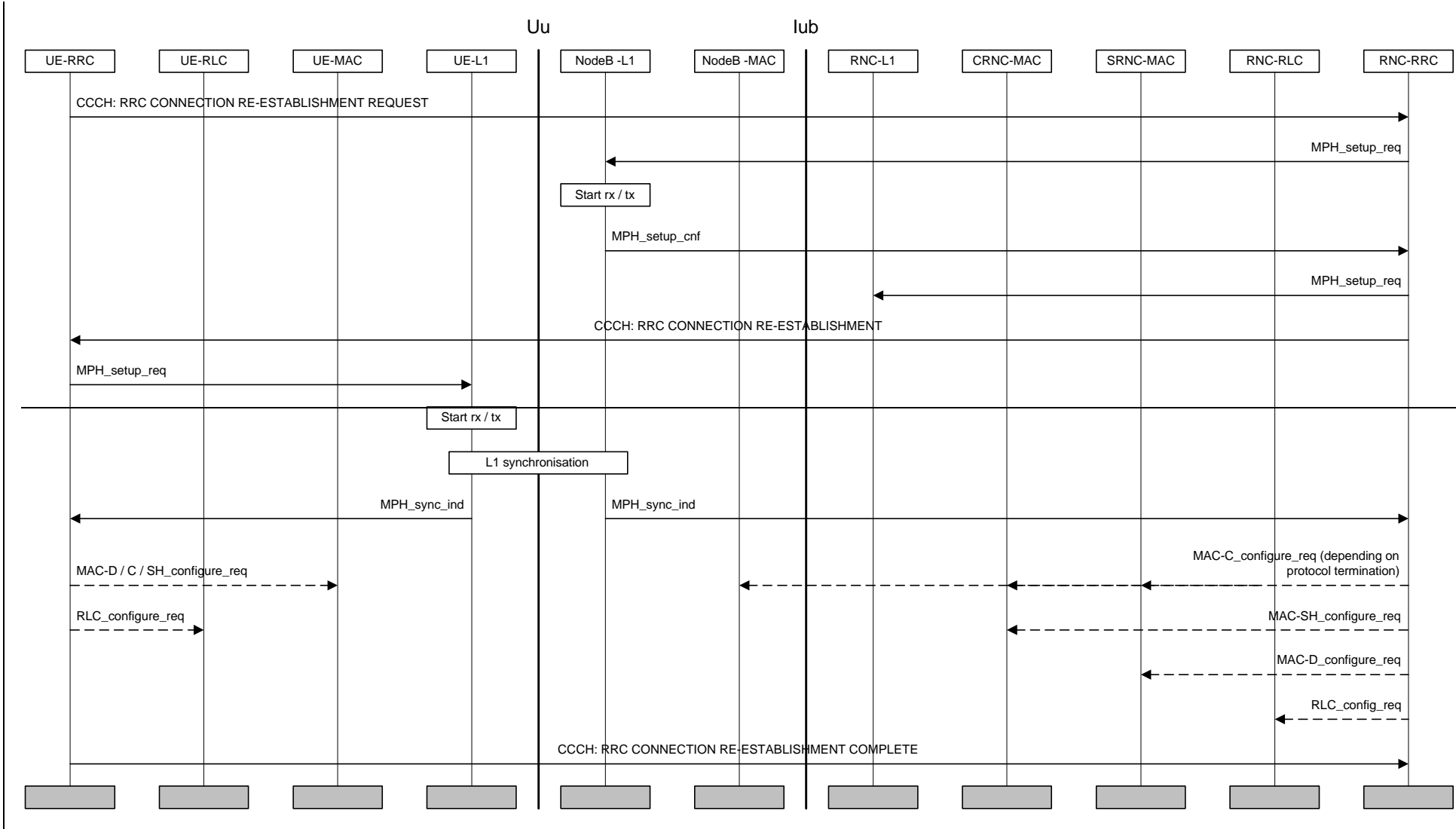

**Figure 30: RRC connection re-establishment**

Figure 30 shows an example of an RRC connection re-establishment procedure. RRC connection re-establishment is needed, when a UE loses radio connection due to e.g. radio link failure. After having selected a new cell, the UE RRC sends the NW RRC an RRC CONNECTION RE-ESTABLISHMENT REQUEST message. The NW RRC configures

the NW and acknowledges the connection re-establishment to the UE RRC with an RRC CONNECTION RE-ESTABLISHMENT message. The UE RRC configures the UE L1 to activate the new radio link(s). After the UE has synchronised to at least one radio link, the MAC and RLC layers can be configured (if necessary).

When the procedure is completed on the UE side, an RRC CONNECTION RE-ESTABLISHMENT COMPLETE message is sent.

## Inter-system Handover: GSM/BSS to UTRAN

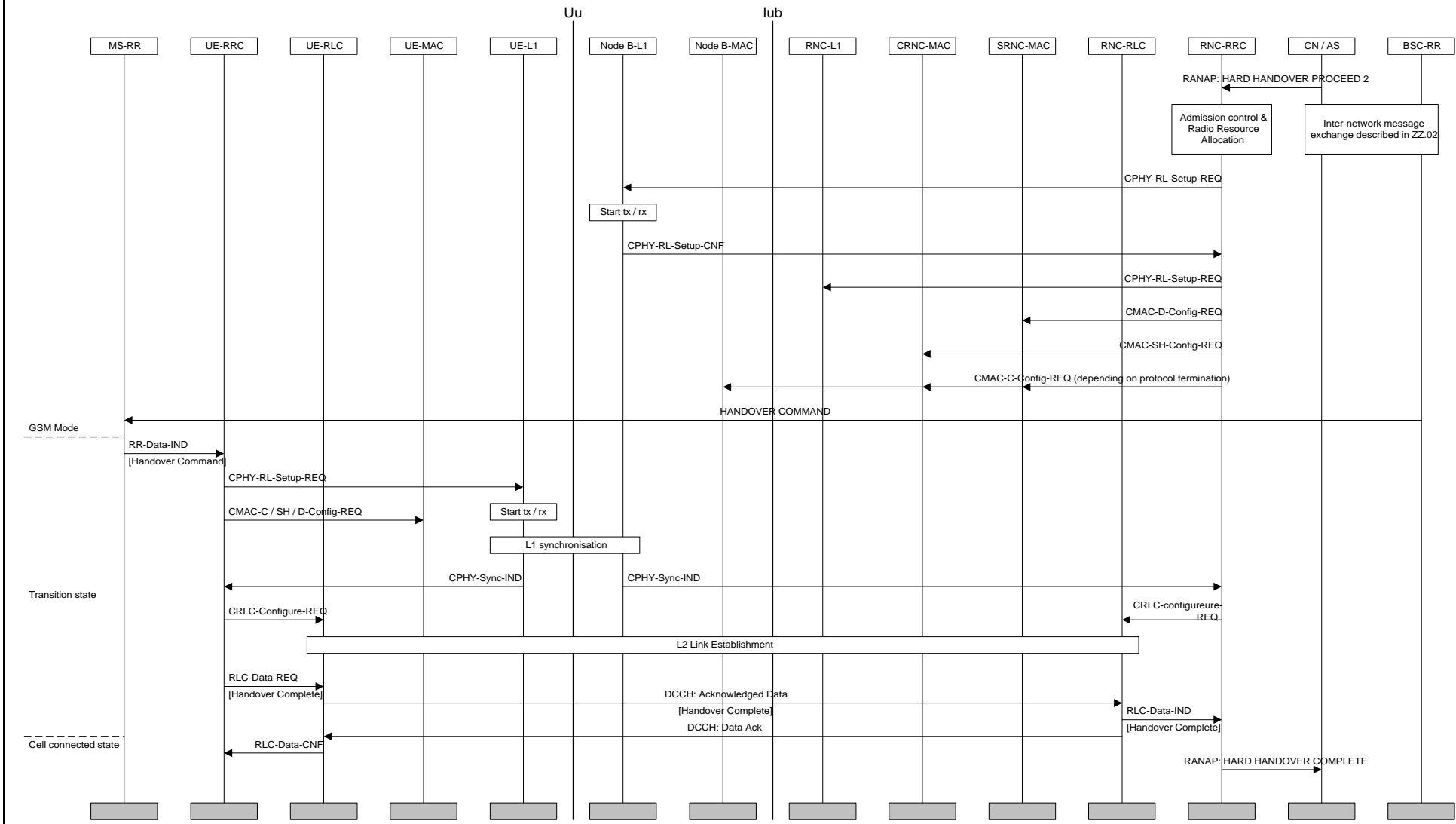



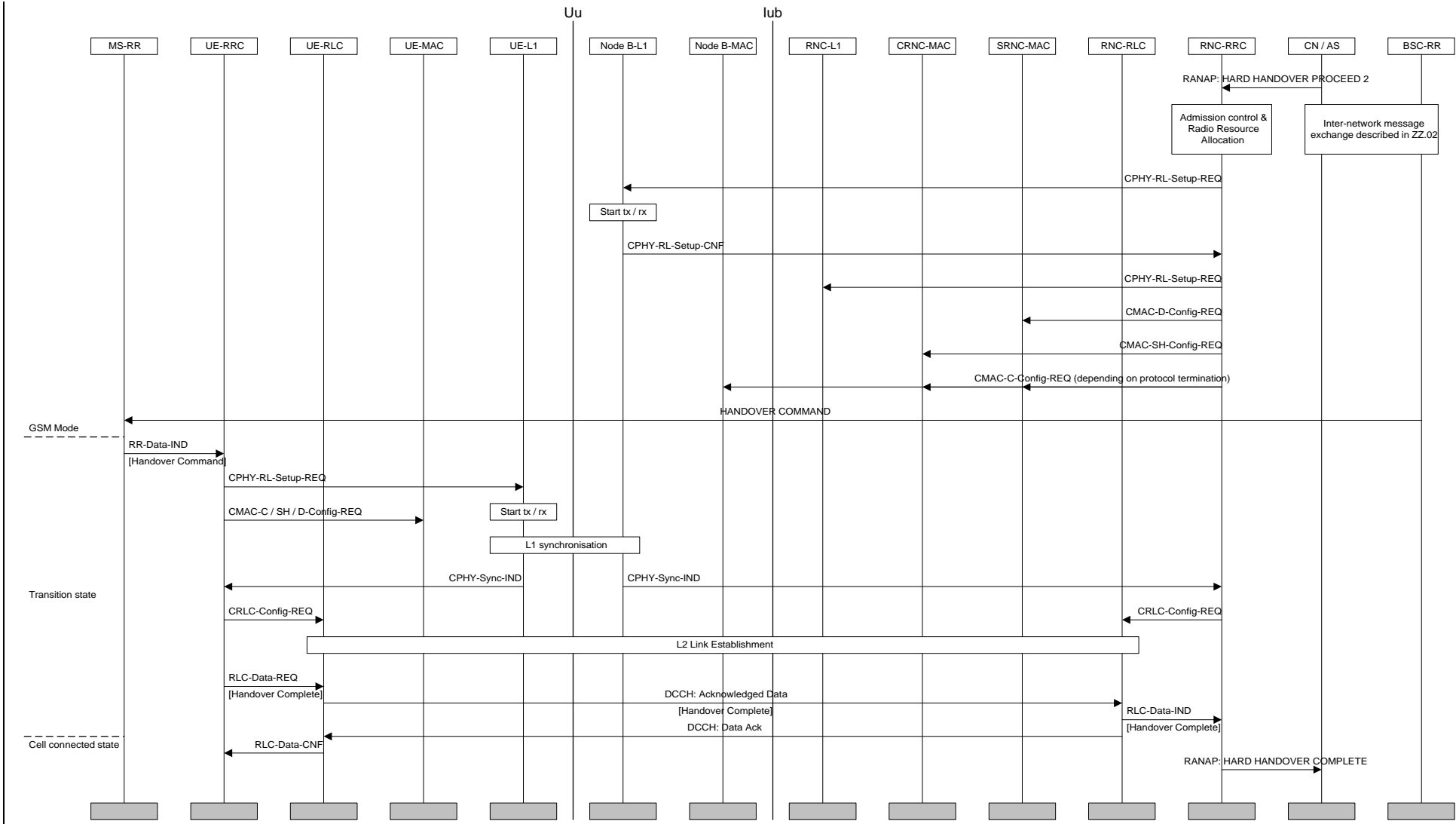

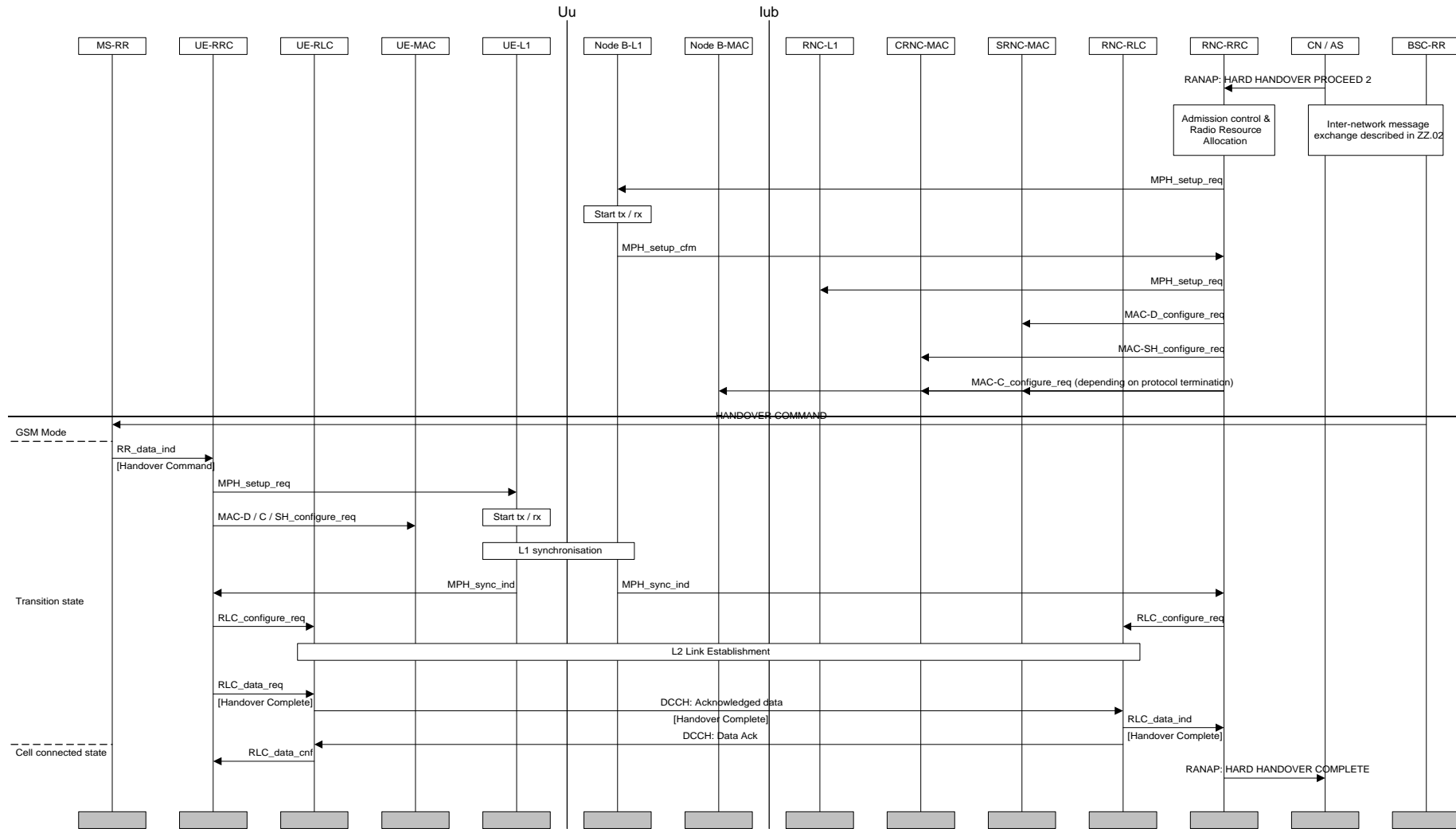

Figure 31: GSM to UMTS inter-system handover

The handover from GSM/BSS to UTRAN for a dual-mode GSM MS / UMTS UE is illustrated in Figure 31. On the network side, upon the reception of a HARD HANDOVER PROCEED 2 command through the RANAP protocol, the RRC layer performs admission control and radio resource allocation assigning an RNTI for the RRC connection and selecting radio resource parameters (such as transport channel type, transport format sets, etc). RRC configures these parameters on layer 1 and layer 2 to locally establish the

DCH logical channel.

The selected parameters including the RNTI, were previously transmitted to UE via RANAP message HARD HANDOVER PROCEED 1 and GSM upgraded message HANDOVER COMMAND.

Upon reception of the HANDOVER COMMAND message, the GSM RR layer transmits the required parameters to the UMTS RRC layer using an RR-Data-IND ~~data\_ind~~ primitive. UE RRC configures L1 and L2 using these parameters to locally establish the DCH logical channel. Layer 1 indicates to RRC when it has reached synchronisation. An RLC signalling link establishment is then initiated by the UE. A HANDOVER COMPLETE message is finally sent by the UE.

## Inter-System Handover: UTRAN to GSM/BSS, PSTN/ISDN domain services

*[Note: The scope of this description is restricted to a UE having a connection only to PSTN/ISDN services, i.e. no simultaneous IP connection]*

For PSTN/ISDN domain services UTRAN Inter-System Handover procedure is based on measurement reports from the UE but initiated from the UTRAN. INTER-SYSTEM HANDOVER COMMAND is sent using acknowledged data transfer on the DCCH. The UE transition from UTRAN Connected Mode starts when an INTER-SYSTEM HANDOVER COMMAND is received. The transition to GSM Connected mode is finished when HANDOVER COMPLETE message is sent from the UE.

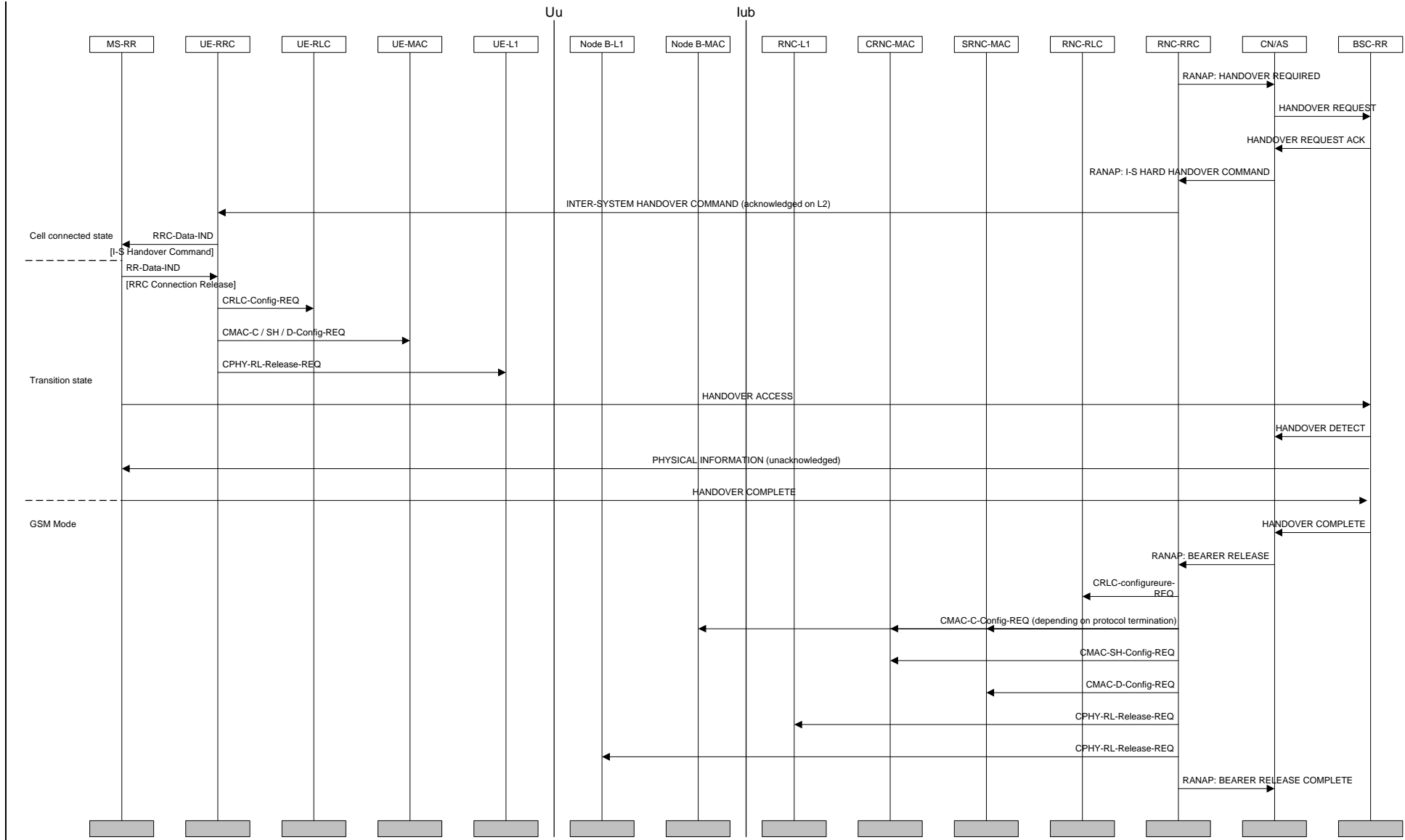

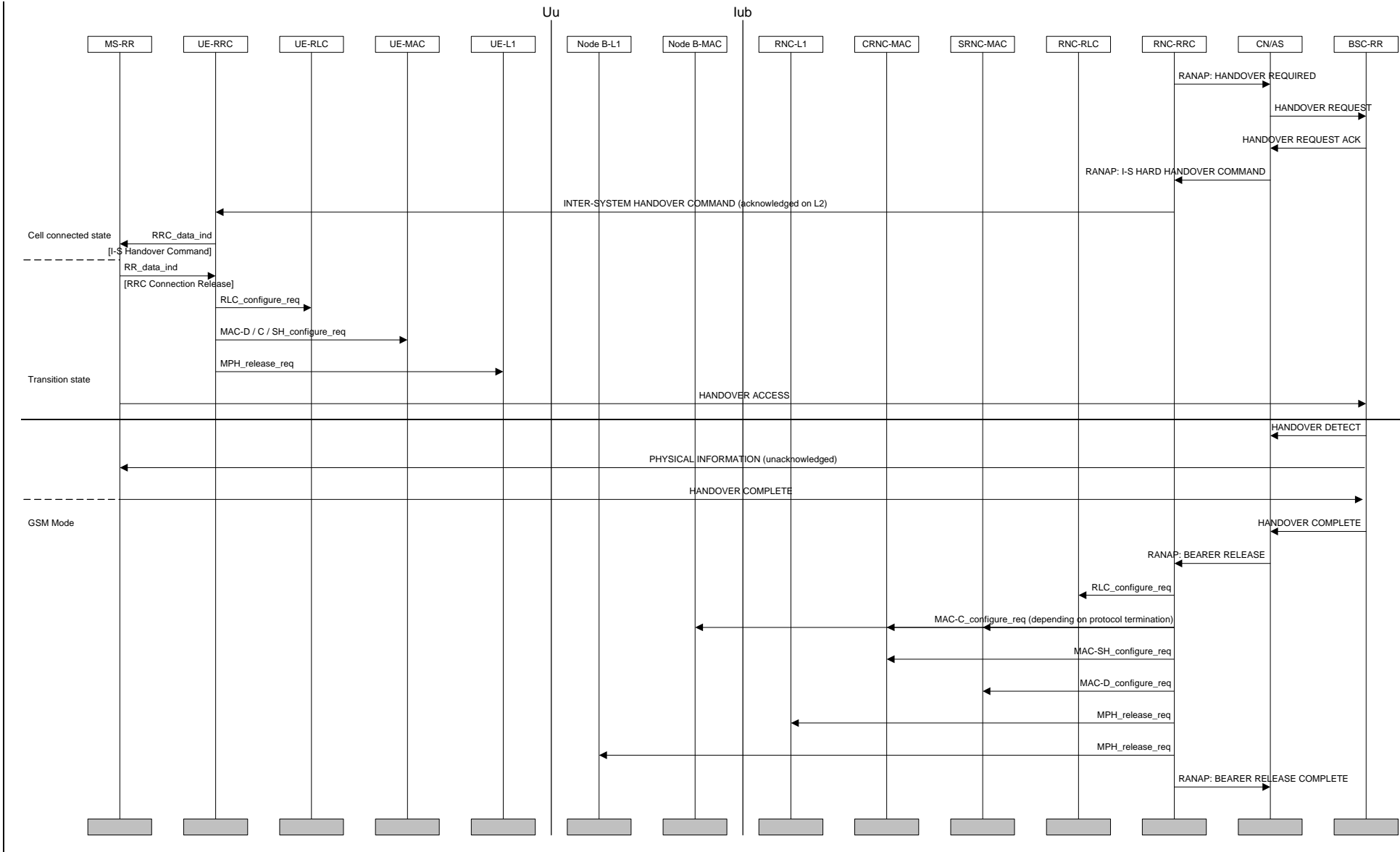

Figure 2. UMTS to GSM inter-system handover.

UTRAN sends a HANOVER REQUIRED to CN/AS. This message contains information needed for the GSM system to be able to perform a handover (e.g. serving cell, target cell). Some parts of this information (e.g. MS classmark) have been obtained at call setup of the UTRAN Connection and are stored in CN.

The CN/AS sends a HANOVER REQUEST message to BSC-RR allocating the necessary resources to be able to receive the GSM MS and acknowledge this by sending HANOVER REQUEST ACKNOWLEDGE to CN/AS. The HANOVER REQUEST ACKNOWLEDGE contains all radio-related information that the UE needs for the handover.

CN/AS sends a INTER-SYSTEM HANOVER COMMAND (type UTRAN-to-BSS HARD HANOVER) to the UE to start the execution of the handover. This message contains all the information needed for the UE to be able to switch to the GSM cell and perform a GSM handover.

Upon reception of the HANOVER COMMAND message, UMTS RRC forwards the handover mparameters to the GSM RR layer using an ~~RRC-Data-IND-data\_ind~~ primitive. To release the resources from UMTS the RR layer transmits to the UMTS RRC an RRC Connection Release message using an ~~RR-Data-IND-data\_ind~~ primitive. The RRC layer can then locally release the resources on the RLC, MAC and physical layers of the UE.

After having switched to the assigned GSM channel received in the INTER-SYSTEM HANOVER COMMAND, the GSM MS sends HANOVER ACCESS in successive layer 1 frames, just as it typically would have done for a conventional GSM handover initiation.

When the BSC-RR has received the HANOVER ACCESS it indicates this to the CN/AS by sending a HANOVER DETECT message. The BSC-RR sends a PHYSICAL INFORMATION message to the GSM MS in unacknowledged mode that contains various fields of physical layer -related information allowing a proper transmission by the MS.

After layer 1 and 2 connections are successfully established, the GSM MS returns the HANOVER COMPLETE message.

CN/AS is then able to release the UTRAN resources that were used for the UE in UTRAN Connected Mode. The CN/AS send a BEARER RELEASE command to UTRAN, after which UTRAN can release all NW resources from RLC, MAC and the physical layer. When the release operation is complete, a BEARER RELEASE COMPLETE message is sent to CN / AS.

# CN originated paging request in connected mode

## UTRAN coordinated paging using DCCH

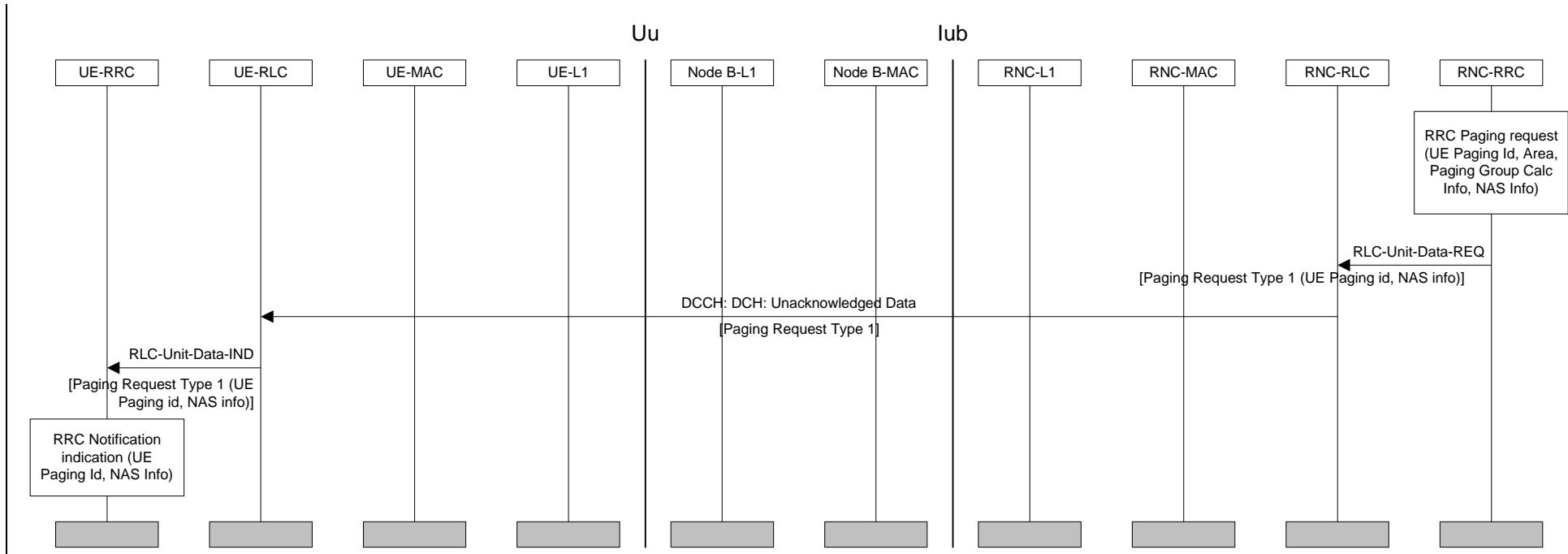

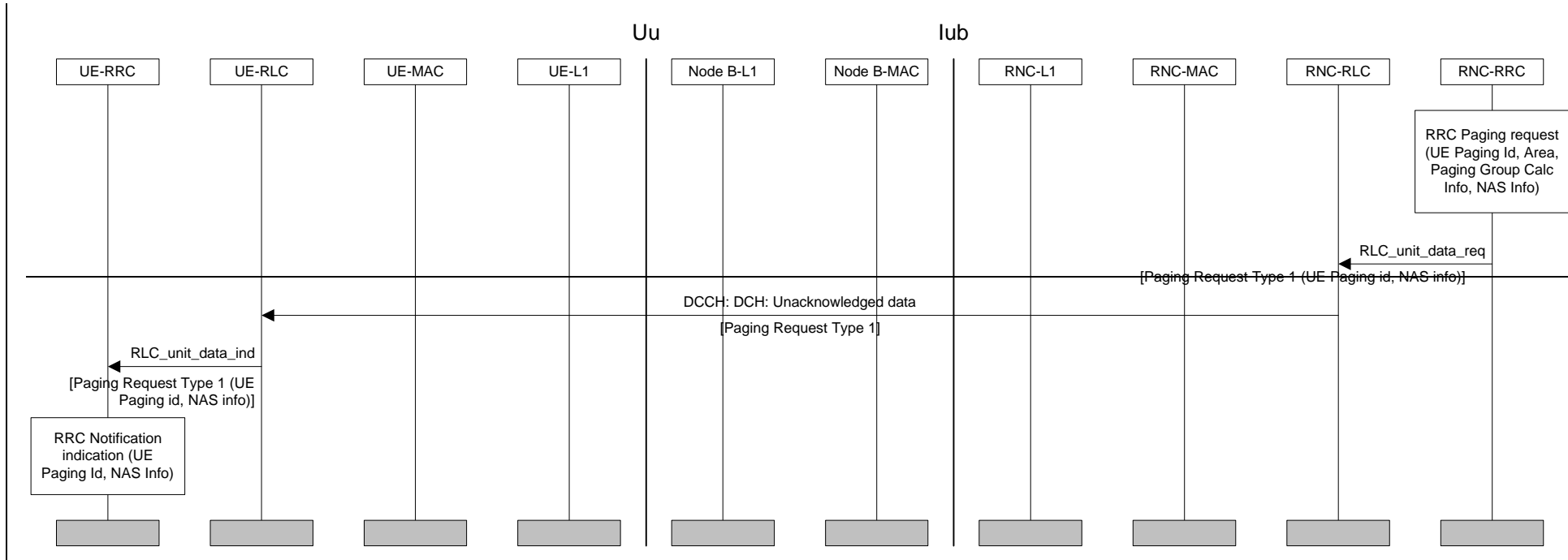

**Figure 32. Example sequence of CN initiated paging request using DCCH**

The above sequence illustrates a CN originated paging request, when the UE is in connected mode and can be reached on the DCCH. The coordination of the paging request with the existing RRC connection is done in UTRAN.

The entity above RRC on the network side requests paging of a UE over the Nt-SAP. The request contains a UE paging identity, an area where the page request is to be broadcast, information for calculation of the paging group and NAS information to be transparently transmitted to the UE by the paging request.

Since the UE can be reached on the DCCH, the RRC layer formats a Paging Request Type 1 message containing the UE paging identity and the NAS information, and the message is transmitted directly to the UE using unacknowledged data transfer.

## UTRAN coordinated paging using PCCH

FFS.

## UE coordinated paging

FFS.



# UTRAN originated paging request and paging response

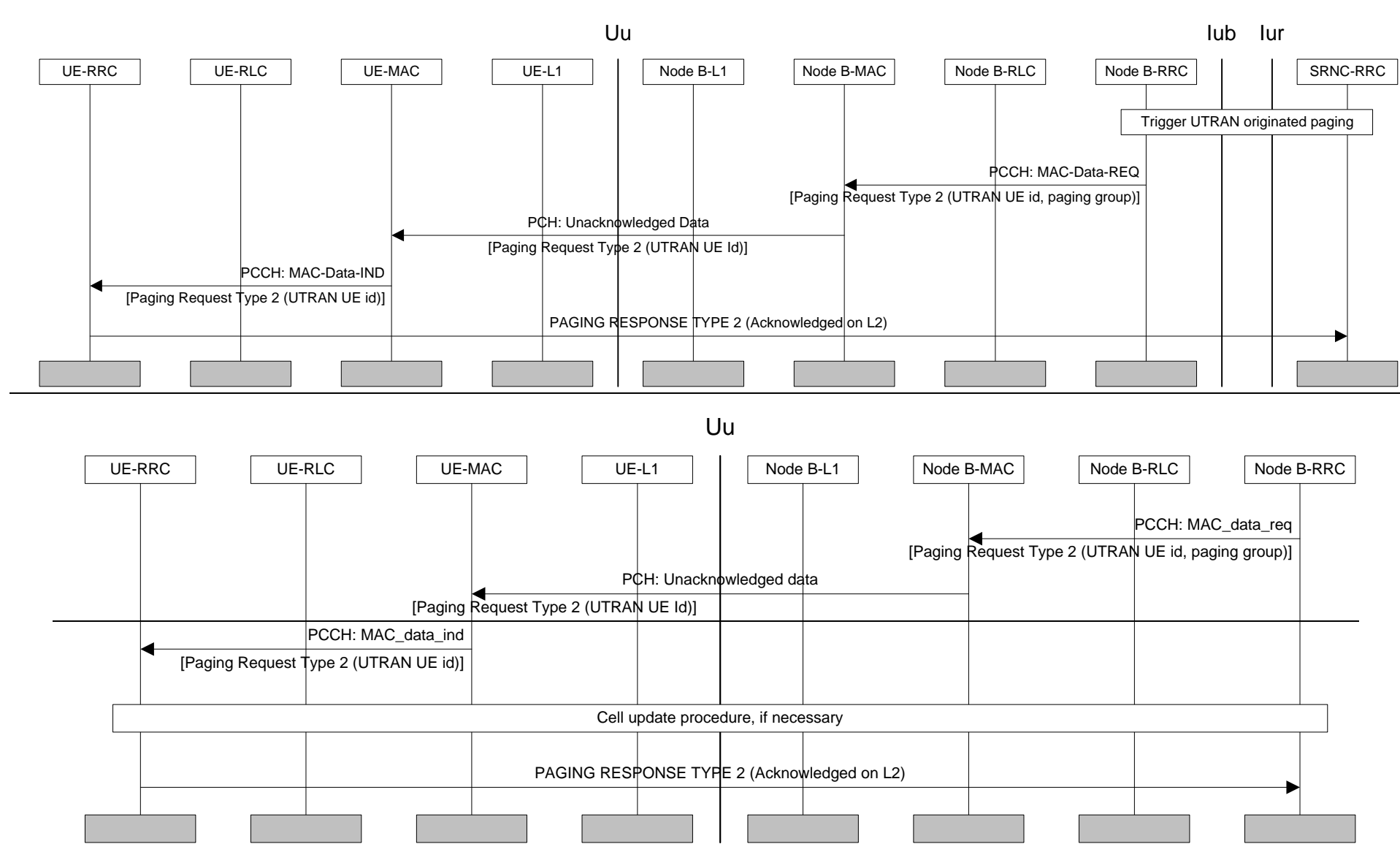

**Figure 33. Example sequence for UTRAN initiated paging request with paging response**

The RRC layer in the network uses this sequence to trigger a switch to RACH/FACH substate of the cell connected state, when the UE can only be reached on the PCH (the PCH substate of cell connected state or the URA connected state). A Paging Request Type 2 message is prepared, containing the UTRAN UE identity (~~s-e.g.-RNTI + RNC-ID~~). The RRC requests the transmission of the message by MAC on the PCCH, indicating the paging group.

In the UE, the RRC layer continuously monitors the paging group on the PCH and compares the UE identities in received paging request messages with its own identities. A match occurs, and in this case the RRC layer changes state to RACH/FACH substate within the cell connected mode.

[Editor's note: According to WG2 LS to WG3 (Tdoc 192) from meeting #2, responses to UTRAN initiated paging requests use RNC-ID + s-RNTI. Therefore a separate cell update procedure should not be necessary, but then a c-RNTI needs to be allocated at some point. A general comment about c-RNTI signalling to UE is inserted below by the editor to indicate this.]

~~Optionally the UE uses the cell update procedure to obtain a new RNTI, before the DCCH can be used.~~

The UE prepares a Paging Response Type 2 message, which is sent on CCCH or the DCCH (FFS).

*[Note: The content of the Paging Response Type 2 message is FFS. It could e.g. be measurements.]*

When the network receives the Paging Response Type 2 message, a c-RNTI is allocated and signalled to UE and the DCCH/DTCH logical channels can be used also in the downlink.

## Other procedures

### UE Capability Information

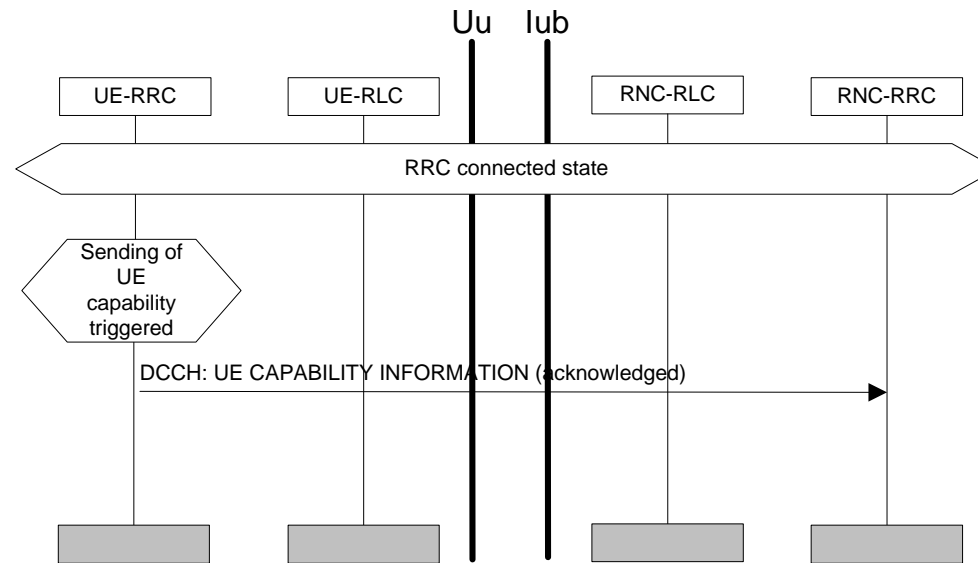

Figure 1. UE Capability Information

The UE transfers its capability information to the network by transmitting the RRC message UE Capability Information using acknowledged mode on the DCCH. This procedure can (optionally) be performed after RRC Connection Setup procedure and also during the lifetime of the RRC Connection if the UE capability information changes (e.g. due to change in UE power class). UE capability information can also explicitly be requested by UTRAN.

# Traffic volume monitoring

An algorithm will be defined for the UE to trigger a message to the NW based on transmitter buffer status.

## History

Document history		
Date	Version	Comment
January 1999	0.0.1	<p>Contents taken from the last version YY.03, "Description of UE States and Procedures in Connected Mode"</p> <p>In "UE-Originated DCH Activation" interlayer figure measurement primitive from RLC to RRC in UE removed.</p>
March 1999	0.0.2	<p>Switched to 3GPP template.</p> <p>Minor fixes to figures:</p> <ul style="list-style-type: none"> <li>• Figure 8 (RRC connection establishment - protocol termination case C) <del>CPHYMPH</del>_sync_ind in NW stretched from RLC to RRC.</li> <li>• Figure 20 (UE-terminated synchronised DCH Modify): DRNC-MAC corrected to SRNC-MAC.</li> <li>• Figure 21 (UE-terminated DCH release): RACH / FACH for the complete-message replaced by RACH.</li> <li>• Figure 30 (RRC connection re-establishment): "REQUEST" removed from CCCH-message from NW to UE, now in line with S2.31.</li> </ul> <p>Other editorial corrections:</p> <ul style="list-style-type: none"> <li>• 7.2.1.1.1 "SETUP" added to the name of RADIO ACCESS BEARER &lt;SETUP&gt; COMPLETE in the text.</li> <li>• 7.2.1.1.2 "ESTABLISHMENT" replaced by "SETUP" in "RADIO ACCESS BEARER &lt;SETUP&gt; COMPLETE"</li> </ul>

<p>March 1999</p>	<p>0.1.0</p>	<ul style="list-style-type: none"> <li>• Editor's notes added to URA and Cell Updates explaining that the logical channel and message routing are FFS and the figures only illustrate one possible realisation.</li> <li>• Figure 2 added from Tdoc 145 (Ericsson) with the modifications agreed by WG2.</li> <li>• DCH / DSCH + DSCH Ctrl substate added according to Tdoc 123 (Alcatel) with a note agreed by WG2.</li> <li>• All primitive names in all MSC-charts changed according to Tdocs 151 (Ericsson) and 187 (Ericsson, NTT DoCoMo, Philips). Note, that TrCH configuration primitives did not exist before, so they are a new addition. Corresponding changes incorporated into text.</li> <li>• Modifications from tdocs 92 and 93 (Nortel Networks) to RRC Connection mobility tasks on PCH and URA Connected substates and the addition of BCH decoding to PCH, URA Connected and RACH/FACH (FFS) (sub)states.</li> </ul>
<p>April 1999</p>	<p>0.1.1</p>	<ul style="list-style-type: none"> <li>• Explanation of s-RNTI and c-RNTI added into chapter 0.</li> <li>• Figure 33 updated to indicate response message termination in SRNC-RRC and clarify the use of identifiers. Optional cell update procedure removed, because according to our LS to WG3, s-RNTI+RNC-ID is used in the response message. Whether the logical channel is then CCCH or DCCH, is left open in the text.</li> </ul>
<p><del>R(Temporary)</del> rapporteur for 3GPP S2.03 is:</p>		
<p>Mikko J. Rinne Nokia Research Center</p> <p>Tel.: +358-9-4376 6825 Email: mikko.j.rinne@research.nokia.com</p>		
<p style="text-align: center;">This document is written using Microsoft Word version 6.0a.</p>		