

3GPP TSG RAN WG1
Pusan, Korea, 10th – 13th October, 2000

TSGR1#16(00)1317

Source: 3GPP TSG RAN WG1
To: 3GPP TSG RAN WG2
Title: LS on Technical Report on HSDPA
Contact: Amitava Ghosh (qa0047@email.mot.com)

RAN WG1 would like to inform RAN WG2 that WG1 has started work on a WG1 Technical Report on HSDPA.

The first draft of the TR entitled “Physical Layer Aspects of UTRA High Speed Downlink Packet Access” is attached to this LS for information, and comments are invited.

WG1 would like to point out that its work on HSDPA is still very much “in progress”. Thus the contents of the attached draft TR should be considered as a preliminary indication of the state of this work.

3G TR V0.1.0(2000-05)

Technical Report

TSG-RAN Working Group1 meeting#16

TSGR1#16(00)1316

Pusan, Korea , 10th-13th Oct. 2000

Agenda Item: TR Outline (For Information Only)

Source: Editor

~~Radio Access Layer Specifications for UTRA High Speed Packet Access~~



The present document has been developed within the 3rd Generation Partnership Project (3GPP™) and may be further elaborated for the purposes of 3GPP.

The present document has not been subject to any approval process by the 3GPP Organisational Partners and shall not be implemented.

This Specification is provided for future development work within 3GPP only. The Organisational Partners accept no liability for any use of this Specification.

Specifications and reports for implementation of the 3GPP™ system should be obtained via the 3GPP Organisational

2(27)

Keyword[, keyword]>

~~Copyright © 2016, 3GPP. All rights reserved. No part of this document may be reproduced or transmitted in any form or by any means electronic or mechanical, including photocopying and recording, or by any information storage or retrieval system, except as may be permitted in writing by 3GPP.~~

~~Copyright~~ reproduced except as authorized by written permission.
~~Notification~~ and the foregoing restriction extend to reproduction in all media.

3(27)

Contents

Foreword	6
1 Scope	7
2 References	7
3 Definitions, symbols and abbreviations	7
3.1 Definitions	7
3.2 Symbols	7
3.3 Abbreviations	7
4 Background and Introduction	7
5 Overview of Technologies considered to support UTRA High Speed Downlink Packet Access	7
5.1 Adaptive Modulation and Coding (AMC)	7
5.2 Hybrid ARQ (H-ARQ)	8
5.3 Fast Cell Selection (FCS)	8
5.4 Multiple Input Multiple Output Antenna Processing	8
6 Proposed Physical Layer structure of High Speed Downlink Packet Access	10
6.1 Basic Physical Structure <frame length, update rates spreading codes, etc>	10
6.1.1 HSDPA physical-layer structure in the code domain	10
6.1.2 HSDPA physical-layer structure in the time domain	10
6.2 Adaptive Modulation and Coding (AMC)	10
6.3 Hybrid ARQ (H-ARQ)	10
6.4 Fast Cell Selection (FCS)	10
6.5 Multiple Input Multiple Output Antenna Processing	10
6.6 Fast scheduling <physical layer interaction>	10
6.7 Associated signaling needed for operation of High Speed Downlink Packet Access	10
6.7.1 Associated Uplink signaling	10
6.7.2 Associated Downlink signaling	11
7 Evaluation of Technologies	12
7.1 Adaptive Modulation and Coding (AMC)	12
7.1.1 Performance Evaluation <throughput, delay>	12
7.1.2 Complexity Evaluation <UE and RNS impacts>	12
7.2 Hybrid ARQ (H-ARQ)	12
7.2.1 Performance Evaluation <throughput, delay>	12
7.2.2 Complexity Evaluation <UE and RNS impacts>	12
7.3 Fast Cell Selection (FCS)	12
7.3.1 Performance Evaluation <throughput, delay>	12
7.3.2 Complexity Evaluation <UE and RNS impacts>	12
7.4 Multiple Input Multiple Output Antenna Processing	12
7.4.1 Performance Evaluation <throughput, delay>	12
7.4.2 Complexity Evaluation <UE and RNS impacts>	12
8 Backwards compatibility aspects	12
9 Conclusions and recommendations	12
10 References	13
11 History	14
12 Annex A Simulation Assumptions and Results	14
12.1 Link Simulation Assumptions	14
12.1.1 Link Assumptions	14
12.1.2 Simulation Description Overview	14
12.1.3 Standard Constellations for M-ary Modulation	15
12.1.4 Turbo decoding	16
12.1.5 Other Decoding	17
12.1.6 Performance Metrics:	17
12.1.7 Simulation Parameters:	18
12.1.8 Simulation Cases	19
12.2 Link Simulation Results	19
12.3 System Simulation Assumptions	19
12.3.1 Common System Level Simulation Assumptions	20
12.3.2 Basic system level parameters	21

4(27)

12.3.3	Data traffic model	21
12.3.4	UE mobility model	22
12.3.5	Packet scheduler	22
12.3.6	Outputs and performance metrics	23
12.3.7	Simulation cases	25
12.3.7.1	Case 1	25
12.3.7.2	Case 2	26
12.4	System Simulation Results	26
13	Annex B: Examples of Performance Evaluation methods	27

5(27)

Foreword

This Technical Specification has been produced by the 3rd Generation Partnership Project (3GPP). The contents of the present document are subject to continuing work within the TSG and may change following formal TSG approval. Should the TSG modify the contents of the present document, it will be re-released by the TSG with an identifying change of release date and an increase in version number as follows:

Version x.y.z

where:

x the first digit:

1 presented to TSG for information;

2 presented to TSG for approval;

3 or greater indicates TSG approved document under change control.

y the second digit is incremented for all changes of substance, i.e. technical enhancements, corrections, updates, etc.

z the third digit is incremented when editorial only changes have been incorporated in the document.

6(27)

1 Scope

This TR describes the techniques behind the concept of high-speed downlink packet access based on a modified DSCH. Furthermore, it describes how this concept should be integrated into the overall architecture of UTRA.

2 References

The following documents contain provisions, which, through reference in this text, constitute provisions of the present document.

References are either specific (identified by date of publication, edition number, version number, etc.) or non-specific.

For a specific reference, subsequent revisions do not apply.

For a non-specific reference, the latest version applies.

[<seq>] <doctype> <#> [([up to and including]{yyyy[-mm]}V<a.b[c]>)[onwards]]: "<Title>".

[1] 3G TS 25.123: "Example 1, using sequence field".

[2] 3G TR 29.456 (V3.1.0): "Example 2, using fixed text".

3 Definitions, symbols and abbreviations

3.1 Definitions

For the purposes of the present document, the [following] terms and definitions [given in ... and the following] apply.

Definition format

<defined term>: <definition>.

example: text used to clarify abstract rules by applying them literally.

3.2 Symbols

For the purposes of the present document, the following symbols apply:

Symbol format

<symbol> <Explanation>

3.3 Abbreviations

For the purposes of the present document, the following abbreviations apply:

Abbreviation format

<ACRONYM> <Explanation>

4 Background and Introduction

The study item HSDPA proposes to study enhancements that can be applied to UTRA in order to provide very high speed downlink packet access.

5 Overview of Technologies considered to support UTRA High Speed Downlink Packet Access

5.1 Adaptive Modulation and Coding (AMC)

The benefits of adapting the transmission parameters in a wireless system to the changing channel conditions is well known. In fact fast power control is an example of a technique implemented to enable reliable communications while simultaneously improving system capacity. The process of modifying the transmission parameters to compensate for the variations in channel conditions is known as *link adaptation*. Another technique that falls under this category of link adaptation, is adaptive modulation and coding (AMC).

The principle of AMC is to change the modulation and coding format in accordance with variations in the channel conditions, subject to system restrictions. The channel conditions can be estimated e.g. based on feedback from the receiver. In case of downlink AMC, fast downlink power control could be disabled. In a system with AMC, users close to the base station are typically assigned higher order modulation with higher code rates (e.g. 64 QAM with R=3/4 Turbo Codes), but the modulation-order and/or code rate will decrease as the distance from base station increases. AMC supports higher data rates allowing higher spectral efficiencies to be achieved possible without the need for fast down link power control. The reduction in interference variation by eliminating fast down link power control may make scheduling easier.

5.2 Hybrid ARQ (H-ARQ)

7(27)

(WG1 note: the contents of this section are for further review and alignment with WG2)

H-ARQ is an implicit link adaptation technique. Whereas, in AMC explicit C/I measurements or similar measurements are used to set the modulation and coding format, in H-ARQ, link layer acknowledgements are used for re-transmission decisions. There are many schemes for implementing H-ARQ - Chase combining, Rate compatible Punctured Turbo codes and Incremental Redundancy. Incremental redundancy or H-ARQ-type-II is another implementation of the H-ARQ technique wherein instead of sending simple repeats of the entire coded packet, additional redundant information is incrementally transmitted if the decoding fails on the first attempt.

H-ARQ-type-III also belongs to the class of incremental redundancy ARQ schemes. However, with H-ARQ-type-III, each retransmission is self-decodable which is not the case with H-ARQ-type II. Chase combining (also called H-ARQ-type-III with one redundancy version) involves the retransmission by the transmitter of the same coded data packet. The decoder at the receiver combines these multiple copies of the transmitted packet weighted by the received SNR. Diversity (time) gain is thus obtained. In the H-ARQ-type-III with multiple redundancy version different puncture bits are used in each retransmission.

AMC by itself does provide some flexibility to choose an appropriate MCS for the channel conditions based on measurements either based on UE measurement reports or network determined. However, an accurate measurement is required and there is an effect of delay. Also, an ARQ mechanism is still required. H-ARQ autonomously adapts to the instantaneous channel conditions and is insensitive to the measurement error and delay. Combining AMC with H-ARQ leads to the best of both worlds - AMC provides the coarse data rate selection, while H-ARQ provides for fine data rate adjustment based on channel conditions.

The choice of H-ARQ mechanism however is important. There are two main ARQ mechanisms - selective repeat (SR) and stop-and-wait (SAW). In SR, only erroneous blocks are re-transmitted. A sequence number is required to identify the block. Typically, in order to fully utilize the available channel capacity the SR ARQ transmitter needs to send a number of blocks while awaiting a response (or lack of it in this case). Hence when combined with H-ARQ the mobile needs to store soft samples for each partially received block. Thus mobile memory requirements can be huge. More importantly, H-ARQ requires that the receiver must know the sequence number prior to combining separate re-transmissions. The sequence number must be encoded separately from the data and must be very reliable to overcome whatever errors the channel conditions have induced in the data. Hence a strong block code is needed to encode the sequence information - increasing the bandwidth required for signaling.

5.3 Fast Cell Selection (FCS)

With Fast Cell Selection, the UE does not receive simultaneous data transmission from multiple cells and therefore performs no combining of traffic channels carrying packet data. Instead, the UE selects the best cell every frame from which it requests the data to be transmitted. The uplink DPCH is used to indicate the required cell from which the network should direct its data transmission to the UE on a frame by frame basis. This technique is a very special case of Site Selection Diversity (SSDT) and applies only to the HS-DSCH. In the case of SSDT, each cell is assigned a temporary ID and UE periodically informs a primary cell ID to the connecting cells. The non-primary cells not selected by the UE switch off their transmitter. However, in the case of Fast Cell selection, the UE selects the best cell every frame from which it wants to receive data on the HS-DSCH. HS-DSCH data is then transmitted to the UE from this cell only.

5.4 Multiple Input Multiple Output Antenna Processing

Diversity techniques based on the use of multiple downlink transmit antennas are well known; second order applications of these have been applied in the UTRA Release 99 specifications. Such techniques exploit spatial and/or polarisation decorrelations over multiple channels to achieve coherent antenna combining and fading diversity gains. Multiple link decorrelation can be exploited further still using multiple antennas and code re-use.

Multiple antennas provide at least three advantages. First, using multiple receive antennas, the gain from coherent antenna combining reduces the required power for achieving a given rate. Alternatively, one can achieve higher rates using the same power, resulting in a higher overall cell throughput. Second, if multiple antennas are available at both the transmitter and receiver so that code re-use can be applied, additional schemes can be defined that have throughputs

8(27)

without going to higher order constellations. In principle, the maximum achievable data rate with code re-use is M times the rate achievable with a single transmit antenna (where M is the number of transmit antennas {and the number of receive antennas must be at least M }). Higher peak throughputs imply not only better average throughputs but also better throughput-delay characteristics. Third, with code re-use, some intermediate data rates can be achieved with a combination of code re-use and small data constellations. Compared to the single antenna transmission scheme with a larger constellation to achieve the same rate, the code re-use technique can have a smaller required E_b/N_0 , resulting in overall improved system performance.

9(27)

6 Proposed Physical Layer structure of High Speed Downlink Packet Access

6.1 Basic Physical Structure <frame length, update rates spreading codes, etc>

On the physical layer, HSDPA transmission should be carried out on a set of downlink physical channels (codes) shared by users at least in the time domain and possibly also in the code domain.

6.1.1 HSDPA physical-layer structure in the code domain

In the code domain, it has been proposed that HSDPA transmission would use a fixed spreading factor and multi-code transmission. The selection of such a fixed HSDPA spreading factor should be based on an evaluation of the impact on

- Performance
- UE complexity
- Flexibility (granularity in the overall allocation of capacity for HSDPA transmission)

Considerations should also be made on to what possible extent there could be any additional flexibility advantages in supporting a variable spreading factor for HSDPA, and compare these with the impact on complexity etc.

6.1.2 HSDPA physical-layer structure in the time domain

In the time domain, the support of HSDPA TTI shorter than one radio frame (10 ms) has been proposed. The length of such shorter HSDPA TTI should be selected from the set $\{T_{\text{slot}}, 3? T_{\text{slot}}, 5? T_{\text{slot}}, 15? T_{\text{slot}}\}$. The selection of such shorter HSDPA TTI should be based on an evaluation of the impact on

- Performance
- Delay
- Network and UE complexity
- Flexibility (HSDPA payload granularity)

6.2 Adaptive Modulation and Coding (AMC)

6.3 Hybrid ARQ (H-ARQ)

6.4 Fast Cell Selection (FCS)

6.5 Multiple Input Multiple Output Antenna Processing

6.6 Fast scheduling <physical layer interaction>

6.7 Associated signaling needed for operation of High Speed Downlink Packet Access

- It is yet to be determined what part of the associated uplink and downlink signaling is to be physical-layer and what part is to be higher-layer signaling, depending on signaling requirements such as periodicity, transmissions delay, and robustness.

6.7.1 Associated Uplink signaling

It is yet to be determined what part of the associated uplink signaling is to be physical-layer and what part is to be higher-layer signaling, depending on signaling requirements such as periodicity, transmissions delay, and robustness. Associated uplink physical signaling may include, but may not be restricted to

- Signaling for measurement reports related to fast link adaptation (Adaptive modulation and coding, AMC), if such measurements are to be supported
- Signaling related to fast cell selection
- Signaling related to fast Hybrid ARQ.

This associated uplink physical signaling should be carried on the uplink DPCCCH. The main impact on current specification is the need for additional uplink DPCCCH slot formats and the possible need for lower spreading factor for the uplink DPCCCH ($SF_{\text{UL-DPCCCH}} < 256$).

6.7.2 Associated Downlink signaling

10(27)

It is yet to be determined what part of the associated downlink signalling is to be physical-layer and what part is to be higher-layer signalling, depending on signaling requirements such as periodicity, transmissions delay, and robustness. Associated downlink physical signalling may include, but may not be restricted to:

- identifying the UE(s) to which HSDPA data is transmitted in a given HSDPA TTI.
- identifying which HSDPA codes are assigned to a UE in a given HSDPA TTI (if sharing in the code domain, i.e. code multiplexing is to be supported for HSDPA transmission)
- identifying modulation and coding scheme used for HSDPA transmission in a given HSDPA TTI.
- identifying relative CPICH to DSCH power ratio for a HSDPA transmission in a given HSDPA TTI (specifically for QAM modulation).
- identifying or setting current states of fast Hybrid ARQ

Two alternatives have been proposed for the downlink physical signalling associated with HSDPA transmission:

- The entire set of associated downlink signaling is carried on associated downlink dedicated physical channels
- Part of the associated downlink signaling is carried on an associated downlink shared signaling/control channel.

The selection between these alternatives should be based on an evaluation differences in terms of

- Complexity
- Capacity (interference-limited capacity as well as code-limited capacity)

11(27)

7 Evaluation of Technologies

7.1 Adaptive Modulation and Coding (AMC)

7.1.1 Performance Evaluation <throughput, delay>

7.1.2 Complexity Evaluation <UE and RNS impacts>

7.2 Hybrid ARQ (H-ARQ)

7.2.1 Performance Evaluation <throughput, delay>

7.2.2 Complexity Evaluation <UE and RNS impacts>

7.3 Fast Cell Selection (FCS)

7.3.1 Performance Evaluation <throughput, delay>

7.3.2 Complexity Evaluation <UE and RNS impacts>

7.4 Multiple Input Multiple Output Antenna Processing

7.4.1 Performance Evaluation <throughput, delay>

7.4.2 Complexity Evaluation <UE and RNS impacts>

8 Backwards compatibility aspects

9 Conclusions and recommendations

10 References

- [1] Motorola. Link Evaluation Methods for High Speed Downlink Packet Access (HSDPA). TSG-R1 document, TSGR#14(00)0910, 4-7th, July, 2000, Oulu, Finland, 6 pp.
- [2] Motorola. Evaluation Methods for High Speed Downlink Packet Access (HSDPA). TSG-R1 document, TSGR#14(00)0909, 4-7th, July, 2000, Oulu, Finland, 15 pp.
- [3] Nokia. High Speed Downlink Packet Access simulation assumptions. TSG-R1 document, TSGR#14(00)0881, 4-7th, July, 2000, Oulu, Finland, 9 pp.
- [4] ETSI SMG2. Universal Mobile Telecommunications System (UMTS); Selection procedures for the choice of radio transmission technologies of the UMTS. ETSI SMG2 Technical Report, TR 101 112 v3.2.0 (UMTS 30.03), 83 pp.
- [5] Gary R. Wright, Richard Stevens. TCP/IP Illustrated, Volume 2: The Implementation, Addison-Wesley Professional Computing.

11 History

Document history		
Date	Version	Comment
10/10/00	0.0.0	First draft
10/12/00	0.1.0	Document flow modified and text added with regard to associated signaling and multiple input and multiple output antenna processing.
Editor for 3G TR xx.xxx is: Amitava Ghosh		
Tel. : 01-847-632-4121 Fax : 01-847-435-0789 Email :		
This document is written in Microsoft Word version.		

12 Annex A Simulation Assumptions and Results

12.1 Link Simulation Assumptions

12.1.1 Link Assumptions

The objective of this section is to propose a set of definitions, assumptions, and a general framework for performing initial link level simulations for High Speed Downlink Packet Access (HSDPA). The objective of these link level simulations is to provide the needed input data to initial system level simulations and to evaluate the link performance of different Adaptive Modulation and Coding schemes and fast Hybrid ARQ methods.

12.1.2 Simulation Description Overview

A symbol level downlink simulator may be used to simulate the performance of higher order modulation schemes and Hybrid ARQ. The general forward link simulation model is shown in Figure 1. The terminology used throughout the document is as follows: I_{or} is the total transmitted power density by a BTS, \hat{I}_{or} is the post-channel transmitted power density, $I_{oc} + N_o$ is the other cell interference plus noise power density and I_o is the total received power density at the MS antenna. Note, that the ratio $\hat{I}_{or} / I_{oc} + N_o$ is fixed in this simulation model. Since the base station has a fixed amount of power (set by the BTS power amplifier size), it is the average transmitted (often called allocated) power by the BTS to the MS that determines the user capacity of the forward link. This fraction of allocated power is called average traffic channel E_c/I_{or} and is inversely proportional to the forward link capacity.

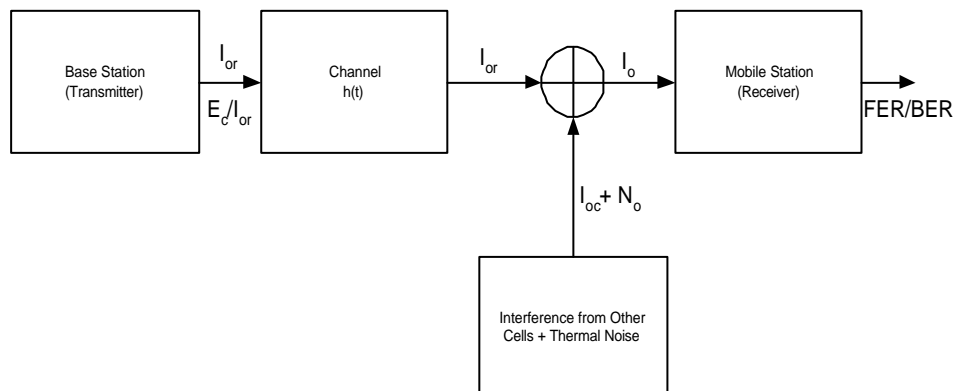

Figure 1. Simulation Block Diagram.

12.1.3 Standard Constellations for M-ary Modulation

In case of 8-PSK modulation, every three binary symbols from the channel interleaver output shall be mapped to a 8-PSK modulation symbol according to Figure 2.

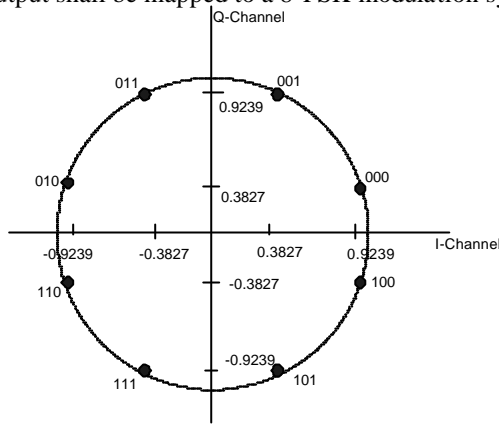

Figure 2. Signal Constellation for 8-PSK Modulation.

In case of 16-QAM modulation, every four binary symbols of the block interleaver output shall be mapped to a 16-QAM modulation symbol according to Figure 3.

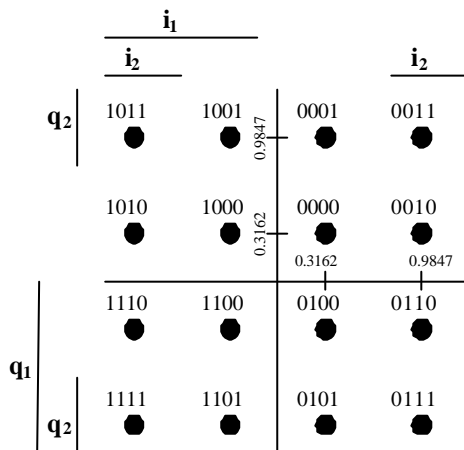

Figure 3. Signal Constellation for 16-QAM Modulation.

In case of 64-QAM modulation, every six binary symbols of the block interleaver output shall be mapped to a 64-QAM modulation symbol according to Figure 4.

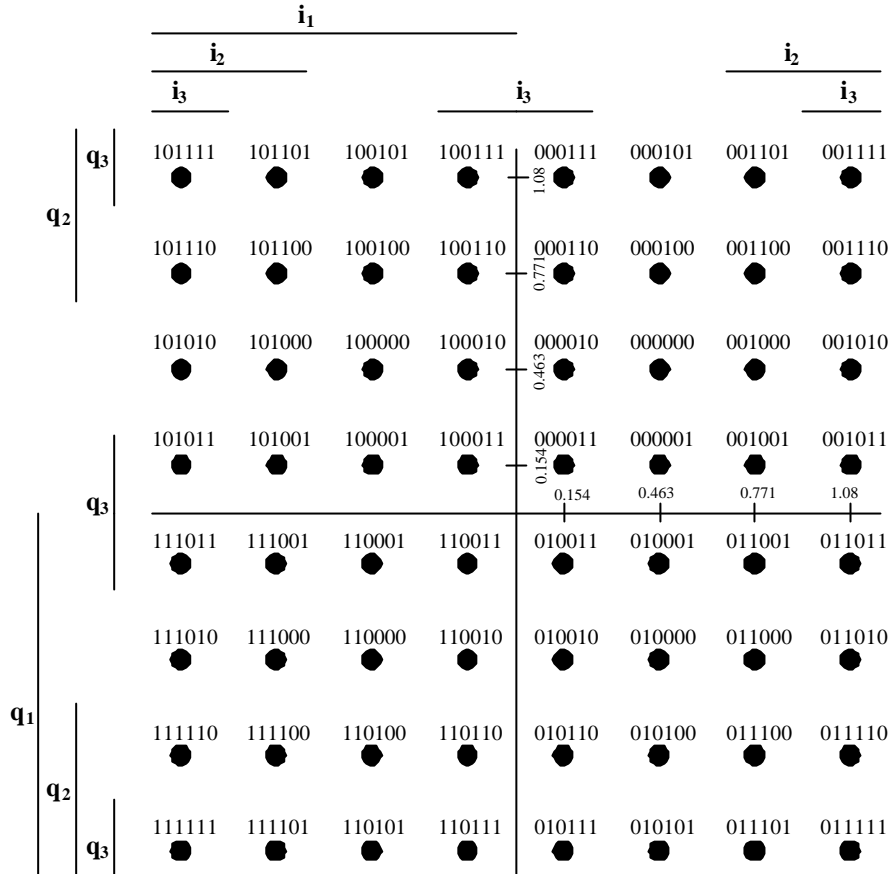

Figure 4. Signal Constellation for 64-QAM Modulation.

12.1.4 Turbo decoding

The M -ary QAM demodulator generates soft decisions as inputs to the Turbo decoder. As a baseline method, the soft inputs to the decoder may be generated by an approximation to the log-likelihood ratio function. First define,

$$L_j^{(i)}(z) = K_f \frac{\min_{j \in S_i} d_j^2}{\min_{j \in \bar{S}_i} d_j^2}, \quad i = 0, 1, 2, \dots, \log_2 M - 1 \quad (1)$$

where M is the modulation alphabet size, i.e. 8, 16, 32 or 64 and

$$z = A_d A_p e^{j\theta} x + n, \quad (2)$$

x is the transmitted QAM symbol, A_d is the traffic channel gain, A_p is the pilot channel gain, $e^{j\theta}$ is the complex fading channel gain, and $A_p e^{j\theta}$ is the fading channel estimate obtained from the pilot channel,

$$S_i = \{j : i^{th} \text{ component of } y_j \text{ is "0"}\}, \quad (3)$$

$$\bar{S}_i = \{j : i^{th} \text{ component of } y_j \text{ is "1"}\} \quad (4)$$

and K_f is a scale factor proportional to the received signal-to-noise ratio. The parameter d_j is the Euclidean distance of the received symbol z from the points on the QAM constellation in S or its complement. The Pilot/Data gain is assumed known at the receiver. In this case the distance metric is computed as follows

$$d_j^2 = |A_p z - Q_j|^2 \quad Q_j \in S_i \text{ or } \bar{S}_i \quad (5)$$

where \hat{A}_d and \hat{A}_p is an estimate formed from the pilot channel after processing through the channel estimation filter.

12.1.5 Other Decoding

12.1.6 Performance Metrics:

The following link performance criteria are used:

1. FER vs. E_c / I_{or} (for a fixed \hat{I}_{or} / I_{oc} & N_o) or

FER vs. \hat{I}_{or} / I_{oc} & N_o (for a fixed E_c / I_{or})

2. Throughput vs. E_c / I_{oc}

where throughput measured in term of bits per second : $T = R \frac{1 - FER_r}{\bar{N}}$ in bits per

second

where T is the throughput, R is the transmitted information bit rate and FER_r is the residual Frame Error Rate beyond the maximum number of transmissions and \bar{N} is the average number of transmission attempts.

12.1.7 Simulation Parameters:

Table 1. provides a list of link-level simulation parameters.

Table 1. Simulation Parameters

Parameter	Value	Comments
Carrier Frequency	2GHz	
Propagation conditions	AWGN, Flat, Pedestrian A (3 Kmph)	Additional channel cases?
Vehicle Speed for Flat Fading	3 kmph/30 kmph/120 kmph	
CPICH relative power	10% (-10dB)	
Closed loop Power Control	OFF	Power control may be used for signalling channels associated with HSDPA transmission
HSDPA frame Length ¹	10ms, 3.33 ms, 0.67 ms	
Ior/Ioc	Variable	
Channel Estimation	Ideal/Non-Ideal(using CPICH)	
Fast fading model	Jakes spectrum	Generated e.g. by Jakes or filtering approach
Channel coding	Turbo code (PCCC), rate 1/4, 1/2, 3/4, etc.	
Tail bits	6	
Max no. of iterations for Turbo Coder	8	
Metric for Turbo Coder	Max ²	
Input to Turbo Decoder	Soft	
Turbo Interleaver	Random	
Number of Rake fingers	Equal to number of taps in the channel model	
Hybrid ARQ	Chase combining	For initial evaluation of fast HARQ. Other schemes may also be studied.
Max number of frame transmissions for H-ARQ		Specify the value used
Information Bit Rates (Kbps)	As defined	
Number of Multicodes Simulated	As defined	
TFCI model	Random symbols, ignored in the receiver but it is assumed that the receiver gets error free reception of TFCI information	
STTD	On/Off	
Other L1 Parameters	As Specified in Release-99 Specification	

Table 2, 3, and 4 shows examples of numerology for HSDPA frames of length 0.67 ms (1 slot), 3.33 ms (5 slots), and 10 ms (15 slots) respectively for different MCS and different number of HSDPA codes³.

Table 2. Information bit rate for frame duration of 0.67 msec

MCS	Chip Rate = 3.84 Mcps			SF = 32			Frame Size = 0.67 ms	
	20 codes			1 code			Code rate	Modulation
	Info Rate	Info bits/frame		Info Rate	Info bits/frame			
	(Mbps)	(bits)	(octets)	(Mbps)	(bits)	(octets)		
7	10.8000	7200	900	0.54	360	45	3/4	64
6	7.2000	4800	600	0.36	240	30	3/4	16
5	4.8000	3200	400	0.24	160	20	1/2	16
4	5.4000	3600	450	0.27	180	22.5	3/4	8
3	3.6000	2400	300	0.18	120	15	3/4	4
2	2.4000	1600	200	0.12	80	10	1/2	4

1	1.2000	800	100	0.06	40	5	1/4	4
---	--------	-----	-----	------	----	---	-----	---

Table 3 . Information bit rate for frame duration of 3.33 msec

Chip Rate = 3.84 Mcps				SF = 32			Frame Size = 3.33 ms	
MCS	20 codes			1 code			Code rate	Modulation
	Info Rate (Mbps)	Info bits/frame (bits)	Info bits/frame (octets)	Info Rate (Mbps)	Info bits/frame (bits)	Info bits/frame (octets)		
7	10.8000	36000	4500	0.54	1800	225	3/4	64
6	7.2000	24000	3000	0.36	1200	150	3/4	16
5	4.8000	16000	2000	0.24	800	100	1/2	16
4	5.4000	18000	2250	0.27	900	112.5	3/4	8
3	3.6000	12000	1500	0.18	600	75	3/4	4
2	2.4000	8000	1000	0.12	400	50	1/2	4
1	1.2000	4000	500	0.06	200	25	1/4	4

Table 4. Information bit rate for frame duration of 10 msec

Chip Rate = 3.84 Mcps				SF = 32			Frame Size = 10.00 ms	
MCS	20 codes			1 code			Code rate	Modulation
	Info Rate (Mbps)	Info bits/frame (bits)	Info bits/frame (octets)	Info Rate (Mbps)	Info bits/frame (bits)	Info bits/frame (octets)		
7	10.8000	1E+05	13500	0.54	5400	675	3/4	64
6	7.2000	72000	9000	0.36	3600	450	3/4	16
5	4.8000	48000	6000	0.24	2400	300	1/2	16
4	5.4000	54000	6750	0.27	2700	337.5	3/4	8
3	3.6000	36000	4500	0.18	1800	225	3/4	4
2	2.4000	24000	3000	0.12	1200	150	1/2	4
1	1.2000	12000	1500	0.06	600	75	1/4	4

12.1.8 Simulation Cases

12.2 Link Simulation Results

12.3 System Simulation Assumptions

The scope of this section is to propose a set of definitions and assumptions on which HSDPA simulations can be based. The initial objective of such system simulations should be to illustrate/verify the potential performance gains due to the currently proposed HSDPA features, such as adaptive modulation and coding scheme (AMCS), fast Hybrid ARQ, and fast cell selection (FCS).

12.3.1 Common System Level Simulation Assumptions

As system level simulation tools and platforms differ between companies very detailed specification of common simulation assumptions is not feasible. Yet, basic simulation assumptions and parameters should be harmonized as proposed in the subsequent chapters.

Various kinds of system performance evaluation methods may be used. In Annex 1, two different methods are outlined. They should be seen as examples and therefore other methods can be used.

12.3.2 Basic system level parameters

The basic system level simulation parameters are listed in Table 5 below.

Table 5. Basic system level simulation assumptions.

Parameter	Explanation/Assumption	Comments
Cellular layout	Hexagonal grid, 3-sector sites	Provide your cell layout picture
Site to Site distance	2800 m	
Antenna pattern	As proposed in [2]	Only horizontal pattern specified
Propagation model	$L = 128.1 + 37.6 \text{ Log}_{10}(R)$	R in kilometers
CPICH power	-10 dB	
Other common channels	- 10 dB	
Power allocated to HSDPA transmission, including associated signaling	Max. 80 % of total cell power	
Slow fading	As modeled in UMTS 3G. B 1.4.1.4	
Std. deviation of slow fading	8 dB	
Correlation between sectors	1.0	
Correlation between sites	0.5	
Correlation distance of slow fading	50 m	
Carrier frequency	2000 MHz	
BS antenna gain	14 dB	
UE antenna gain	0 dBi	
UE noise figure	9 dB	
Max. # of retransmissions	Specify the value used	Retransmissions by fast HARQ
Fast HARQ scheme	Chase combining	For initial evaluation of fast HARQ
BS total Tx power	Up to 44 dBm	
Active set size	3	Maximum size
Specify Fast Fading model	Jakes spectrum	Generated e.g. by Jakes or Filter approach

12.3.3 Data traffic model

The described data-traffic model simulates bursty web traffic. The parameters of the model are based on [4] but have been tailored to reduce simulation run time by decreasing the number of UEs required to achieve peak system loading. The main modification is to reduce the reading time between packet calls. In addition, TCP/IP rate adaptation mechanisms have been included to pace the packet arrival process of packets within a packet call.

The model assumes that all UEs dropped are in an active packet session. These packet sessions consist of multiple packet calls representing Web downloads or other similar activities. Each packet call size is modeled by a truncated Pareto distributed random variable producing a mean packet call size of 25 Kbytes. Each packet call is separated by a reading time. The reading time is modeled by a Geometrically distributed random variable with a mean of 5 seconds. The reading time begins when the UE has

received the entire packet call. Each packet call is segmented into individual packets. The time interval between two consecutive packets can be modeled in two ways, as an open loop process or as a closed loop process. The open loop process models the timer interval as a geometrically distributed random variable. Specifically, the mean packet inter-arrival time will be set to the ratio of the maximum packet size divided by the peak link speed. The closed loop model will incorporate the "slow-start" TCP/IP rate control mechanism for pacing packet traffic. Slow-start will be implemented as described in [5]. A total round trip network delay of 100 ms will be assumed for TCP ACK feedback.

The fundamentals of the data-traffic model are captured in Table 6.

Table 6. Data-traffic model parameters.

Process	Random Variable	Parameters
---------	-----------------	------------

Packet Calls Size	Pareto with cutoff	$\alpha = 1.1, k=4.5$ Kbytes, $m=2$ Mbytes, $\mu = 25$ Kbytes
Time Between Packet Calls	Geometric	$\mu = 5$ seconds
Packet Size	Segmented based on MTU size	(e.g. 1500 octets)
Packets per Packet Call	Deterministic	Based on Packet Call Size and Packet MTU
Packet Inter-arrival Time (open-loop)	Geometric	$\mu = \text{MTU size} / \text{peak link speed}$ (e.g. $[1500 \text{ octets} * 8] / 2 \text{ Mbps} = 6 \text{ ms}$)
Packet Inter-arrival Time (closed-loop)	Deterministic	TCP/IP Slow Start (Fixed Network Delay of 100 ms)

12.3.4 UE mobility model

A static or dynamic UE mobility model can be used. Both fixed UE speed or a speed distribution may be used. In the latter case the speed distribution given in Figure 5 shall be used, see also Table 7. A speed is assigned to each user at the beginning of the simulation and will not be changed during the simulation. Stationary UEs signal paths will be Rician faded with K factor of 12dB and 2Hz Doppler spread.

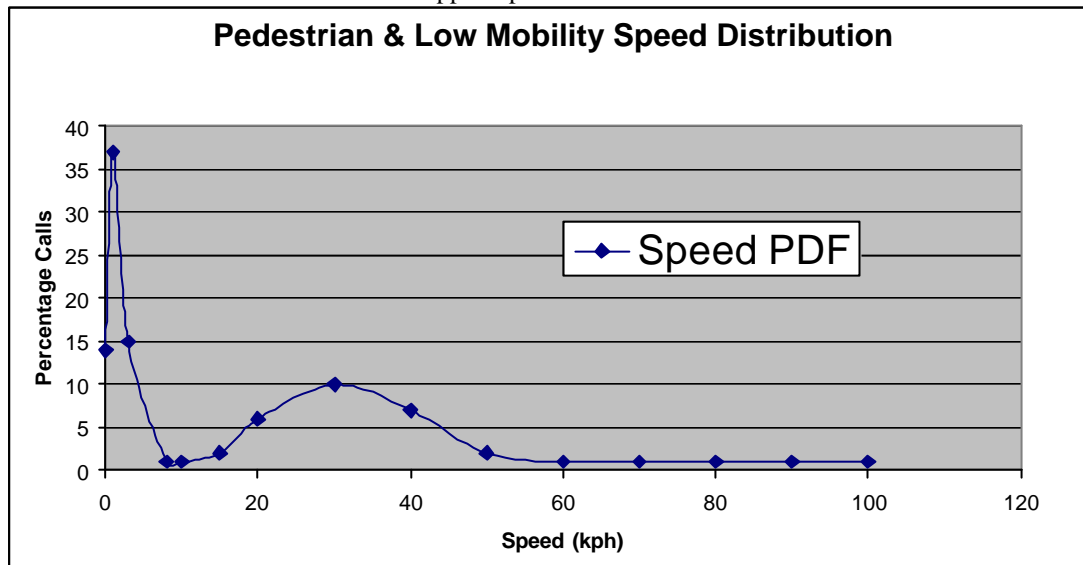

Figure 5. Pedestrian and low mobility speed distribution

Table 7. Speed distribution

Speed (kph)	0	1	3	8	10	15	20	30	40	50	60	70	80	90	100
Percentage	14	37	15	1	1	2	6	10	7	2	1	1	1	1	1

12.3.5 Packet scheduler

Multiple types of packet schedulers may be simulated. However, initial results may be provided for the two simple schedulers provided below that bound performance. The first scheduler (C/I based) provides maximum system capacity at the expense of fairness, because all frames can be allocated to a single user with good channel conditions. The Round Robin (RR) scheduler provides a more fair sharing of resources (frames) at the expense of a lower system capacity.

Both scheduling methods obey the following rules:

An ideal scheduling interval is assumed and scheduling is performed on a frame by frame basis.

The “frame” is defined by the HSDPA concept, e.g. 0.67ms (1 slot), 3.33ms (5 slots), or 10 ms (15 slots).

A queue is 'non-empty' if it contains at least 1 octet of information.

Packets received in error are explicitly rescheduled after the ARQ feedback delay consistent with the HSDPA definition.

A high priority queue is maintained to expedite the retransmission of failed packet transmission attempts. Entry into the high priority queue will be delayed by a specified time interval (e.g. 5 frame intervals) to allow for scheduler flexibility⁴. If the packet in the high-priority queue is not rescheduled after a second time interval (e.g. 10 frame intervals) it is dropped.

Packets from the low priority queue may only be transmitted after the high-priority queue is empty.

Transmission during a frame cannot be aborted or pre-empted for any reason

The C/I scheduler obeys the following additional rules:

At the scheduling instant, all non-empty source queues are rank ordered by C/I for transmission during a frame.

The scheduler may continue to transfer data to the UE with the highest C/I until the queue of that UE is empty, data arrives for another UE with higher C/I, or a retransmission is scheduled taking higher priority.

Both high and low priority queues are ranked by C/I.

The RR scheduler obeys the following rules:

At the scheduling instant, non-empty source queues are serviced in a round-robin fashion.

All non-empty source queues must be serviced before re-servicing a user.

Therefore, the next frame cannot service the same user as the current frame unless there is only one non-empty source queue.

The scheduler is allowed to group packets from the selected source queue within the frame.

12.3.6 Outputs and performance metrics

The following suggested performance metrics for both the entire system and the center site taken over each simulation run may be provided. In all cases, a packet is as defined by the traffic model.

Percentage of users as a function of throughput for different loading levels

Throughput is measured on a per packet basis and is equal to the number of information bits divided by the total transmission time. In other words, retransmissions are accounted for and reduce the peak data rate statistic. The total transmission time is defined to include the time to transmit the initial attempt and each subsequent retry.

For example, consider a packet "m":

Packet *m* contains I_m information bits.

Packet requires three attempts to transmit.

Packet *m* takes $T_{m,j}$ seconds to transmit for attempt *j*

$$R(m) = \frac{I_m}{\sum_{j=1}^3 T_{m,j}} \quad (1)$$

Figure 6 shows a sample output graph.

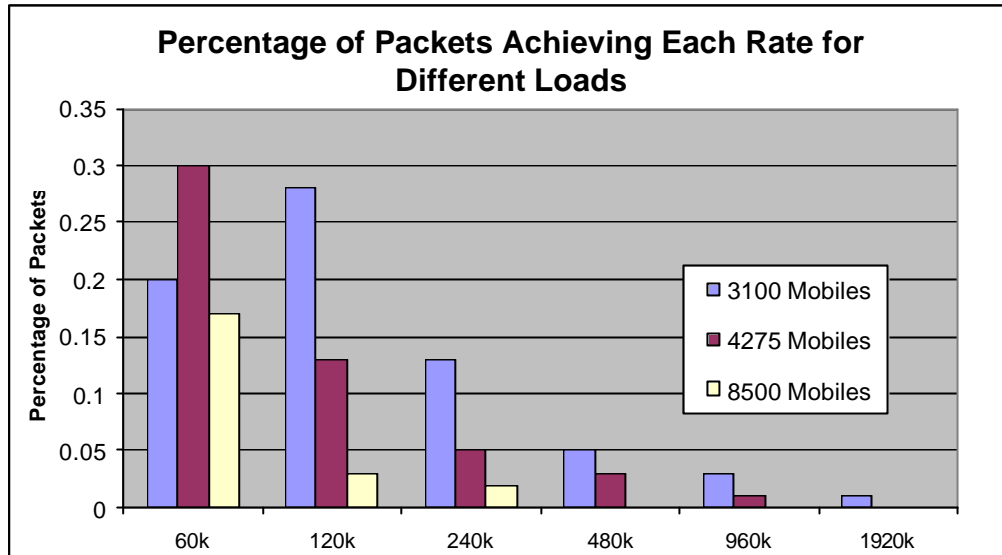

Figure 6. Percentage of Packets as function of throughput for the different loading levels.
 Mean distance from serving site for each throughput level, measured per packet
 The rate of each packet is calculated as in the previous section. A sample output graph is shown in the Figure 7.

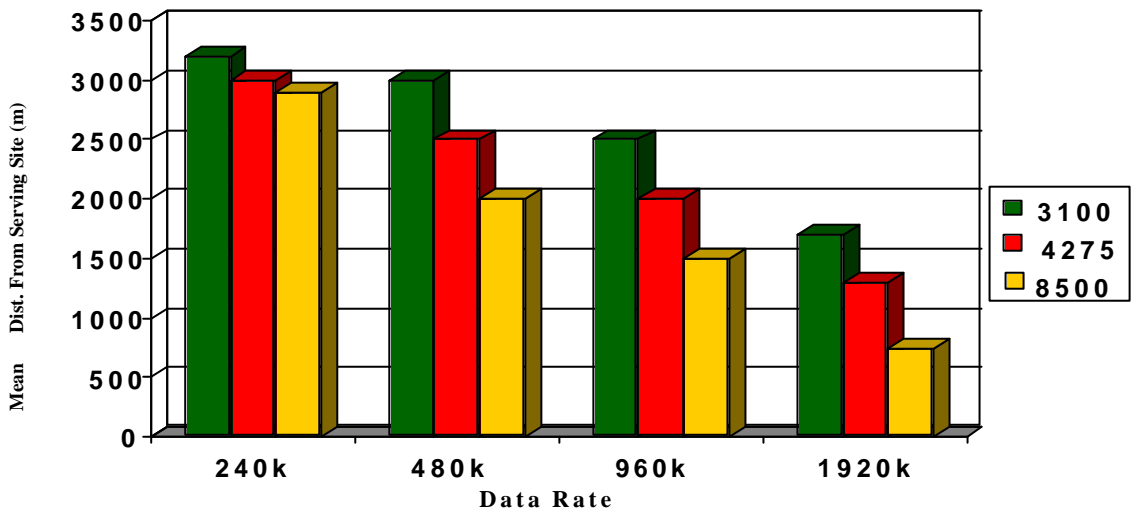

Figure 7. Mean Distance from serving site for each throughput level.
 The following statistics as a function of offered load may also be provided
 Throughput per sector: Total number of bits successfully transferred divided by the total number of sectors and simulation duration.
 Average and Variance of Packet Call Completion Time – measured from when the first packet of a packet call arrives at the base station’s queue to when the final packet of the packet call is received by the UE station
 Average and Variance Packet Call Transfer Rate - defined as the payload size of a packet call divided by the transfer time where transfer time is measured from when the first packet of a packet call is transmitted by the base station to when the final packet of the packet call is received by the UE station
 Service Rate – the number of completed packet calls per second.

12.3.7 Simulation cases

In order to evaluate the performance of the basic features proposed for HSDPA (AMCS, fast HARQ and FCSS), at least the simulation cases described below should be conducted. In both cases the performance reference is the Rel.-99 system.

12.3.7.1 Case 1

In case 1, adaptive modulation and coding (AMCS) and fast HARQ will be modeled.

The following parameters will be used:

MCS may be selected based on CPICH measurement, e.g. RSCP/ISCP, or power control feedback information

MSC update rate: once per 3.33 ms (5 slots)

CPICH measurement transmission delay: 1 frame

Selected MCS applied with 1 frame delay after receiving measurement report

Std. dev. of CPICH measurement error: 0, 3dB

CPICH measurement rate: once per 3.33 ms

CPICH measurement report error rate: 1 %

Frame length for fast HARQ: 3.33 ms

Fast HARQ feedback error rate: 0%, 1% or 4 %.

12.3.7.2 Case 2

12.4 System Simulation Results

In case 2 all the three techniques (fast HARQ, AMC, and FCSS) will be modeled. The parameters are as for case 1, with the addition of:

Cell selection rate: once per 3.33 ms

Cell selection error rate: 1 %

FCSS request transmission and cell selection delay: 2 frames

13 Annex B: Examples of Performance Evaluation methods

In the following, two examples of system performance evaluation methods are briefly described. First one is a combination of simulations and analytic evaluation and second one is based on dynamic system level simulations.

A. Analytic Simulation

In this method C/I statistics for all locations in a 19 cell, 3-sectored system is created and the corresponding C/I histogram is obtained. Next, from the link simulations the Throughput vs. C/I results are obtained for various MCS with STTD and Hybrid ARQ. The link and system simulation results are then combined and post-processed to obtain average sector throughput for various classes of scheduler.

The flow diagram of this method is shown in Figure 8.

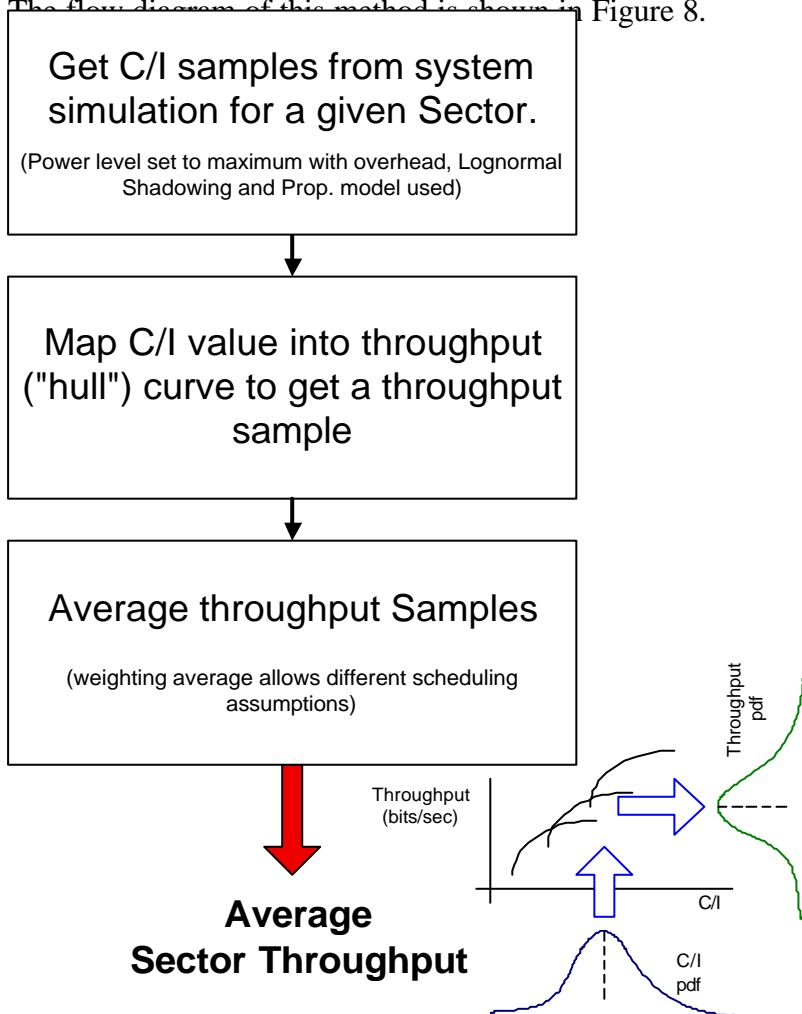

Figure 8. Analytic Simulation Flow Chart

In order to get an estimate of capacity the Max/Min scheduler as shown in Figure 9 is used. In this scheduler users with throughput above their own average get Max/Min more packets than users below the their own average.

Figure 9. Max/Min schedulers

B. Dynamic system level simulations

Determining high rate packet data system performance requires a dynamic system simulation tool to accurately model feedback loops, signal latency, site selection, protocol execution, random packet arrival, and mobility in a multipath fading environment. The packet system simulation tool will include Rayleigh and Rician

fading and evolve in time with discrete steps (e.g. time steps of 0.667ms). The time steps need to be small enough to correctly model feedback loops, latencies, scheduling activities, measurements of required system metrics (e.g. C/I similar to CPICH Ec/No), and fast cell site selection. A Ec/Ior vs. FER curve for a AWGN (static) channel will be created using a link level simulation for each data rate, modulation and coding scheme to determine successful over the air packet delivery. Sampling Eb/Nt points over each frame creates a frame metric. For a given frame the metric is used with the static curve to determine if the frame is erased. Alternatively, one can also use an array of Ec/Ior vs. FER curve for different fading conditions, geometries, speeds and MCS which will then be used in the system simulation to determine whether a frame is erased or not. Lognormal shadowing, delay spread, and fractional recovered power (per ray) will also be modeled. Scheduling and MAC will be included in the simulation to the detail necessary to model the data traffic allocation interface. The data traffic allocation interface is intended to capture the interaction between radio link algorithms/designs and end-user applications. As such, it is proposed that both best effort and real-time models be simulated to capture air-interface performance. Ideally, best effort services should be modeled by a closed-loop traffic model in the form of a full web browsing model operating over a TCP/IP stack. The close-loop traffic model provides a variable IP packet stream that reacts to the quality of the radio link and the policies of the radio network's packet scheduler. Furthermore, the close-loop traffic model should properly model the bursty nature of data traffic and limit the simulation scheduler to a causal implementation that operates on available information such as the current queue depths and bounds buffering delays to practical levels. The ideal real-time model combines specific frame-erasure rates and delay guarantees to test the capability of the air interface. These real-time models will likely consume greater resources than best effort service. The ability of the air-interface to meet these guarantees may be measured by both the probability of blocking and the residual capacity remaining for best effort services.