

**Technical Specification Group Services and System Aspects TSGS#27(05)0160**  
**Meeting #27, 14 - 17 March 2005, Tokyo, Japan**

**Source:** TSG SA WG2  
**Title:** CR(s) to 23.979  
**Agenda item:** 7.2.3  
**Document for:** APPROVAL

---

S2 Tdoc	Title	Spec	CR	Rev	Cat	C_Ver	Rel	WI
S2-050528	Impact on Charging Correlation	23.979	1	3	F	6.0.0	Rel-6	PoC
S2-050346	QoS of pre-established PDP context	23.979	2	1	F	6.0.0	Rel-6	PoC
S2-050347	Alignment of 23.979 with OMA architecture	23.979	3	1	F	6.0.0	Rel-6	PoC

Budapest, Hungary. 26th Jan. - 2nd Feb. 2005.

CR-Form-v7.1	
<b>CHANGE REQUEST</b>	
⌘ 23.979 CR 001 ⌘ rev 3 ⌘	Current version: 6.0.0 ⌘

For **HELP** on using this form, see bottom of this page or look at the pop-up text over the ⌘ symbols.

**Proposed change affects:** | UICC apps  ME  Radio Access Network  Core Network

<b>Title:</b>	⌘ Impact on Charging Correlation		
<b>Source:</b>	⌘ 3GPP TSG_SA WG2		
<b>Work item code:</b>	⌘ POC	<b>Date:</b>	⌘ 01/02/2005
<b>Category:</b>	⌘ F	<b>Release:</b>	⌘ R6
	Use <u>one</u> of the following categories: F (correction) A (corresponds to a correction in an earlier release) B (addition of feature), C (functional modification of feature) D (editorial modification) Detailed explanations of the above categories can be found in 3GPP <a href="#">TR 21.900</a> .		Use <u>one</u> of the following releases: Ph2 (GSM Phase 2) R96 (Release 1996) R97 (Release 1997) R98 (Release 1998) R99 (Release 1999) Rel-4 (Release 4) Rel-5 (Release 5) Rel-6 (Release 6) Rel-7 (Release 7)

<b>Reason for change:</b>	⌘ TS 24.229 has described the principles of charging correlation and procedures for ICID essentially. Some detailed description need to be addressed for PoC implementation.
<b>Summary of change:</b>	⌘ It is proposed that a new section for charging correlation need to be added to TR 23.979 section 5.
<b>Consequences if not approved:</b>	⌘ The PoC charging correlation is missing.

<b>Clauses affected:</b>	⌘ Add a new subclause 5.6 in clause 5.										
<b>Other specs affected:</b>	<table border="1" style="display: inline-table; border-collapse: collapse;"> <tr> <td style="width: 20px; text-align: center;">Y</td> <td style="width: 20px; text-align: center;">N</td> </tr> <tr> <td style="text-align: center;"><input checked="" type="checkbox"/></td> <td style="text-align: center;"><input checked="" type="checkbox"/></td> </tr> <tr> <td style="text-align: center;"><input checked="" type="checkbox"/></td> <td style="text-align: center;"><input checked="" type="checkbox"/></td> </tr> <tr> <td style="text-align: center;"><input checked="" type="checkbox"/></td> <td style="text-align: center;"><input checked="" type="checkbox"/></td> </tr> </table> Other core specifications ⌘ Test specifications ⌘ O&M Specifications ⌘	Y	N	<input checked="" type="checkbox"/>	<input checked="" type="checkbox"/>	<input checked="" type="checkbox"/>	<input checked="" type="checkbox"/>	<input checked="" type="checkbox"/>	<input checked="" type="checkbox"/>		
Y	N										
<input checked="" type="checkbox"/>	<input checked="" type="checkbox"/>										
<input checked="" type="checkbox"/>	<input checked="" type="checkbox"/>										
<input checked="" type="checkbox"/>	<input checked="" type="checkbox"/>										
<b>Other comments:</b>	⌘										

**How to create CRs using this form:**

Comprehensive information and tips about how to create CRs can be found at <http://www.3gpp.org/specs/CR.htm>. Below is a brief summary:

- 1) Fill out the above form. The symbols above marked  contain pop-up help information about the field that they are closest to.
- 2) Obtain the latest version for the release of the specification to which the change is proposed. Use the MS Word "revision marks" feature (also known as "track changes") when making the changes. All 3GPP specifications can be downloaded from the 3GPP server under <ftp://ftp.3gpp.org/specs/> For the latest version, look for the directory name with the latest date e.g. 2001-03 contains the specifications resulting from the March 2001 TSG meetings.
- 3) With "track changes" disabled, paste the entire CR form (use CTRL-A to select it) into the specification just in front of the clause containing the first piece of changed text. Delete those parts of the specification which are not relevant to the change request.

-----start-----

## 5.6 PoC Charging Correlation

PoC is provided as a service over IM CN. This implies that the existing IMS charging correlation information and mechanisms should be reused.

See 3GPP TS 24.229[16] for further information on charging correlation.

-----end-----

## CHANGE REQUEST

23.979 **CR 002** rev **1** Current version: **6.0.0**

For **HELP** on using this form, see bottom of this page or look at the pop-up text over the ☞ symbols.

**Proposed change affects:** | UICC apps  ME  Radio Access Network  Core Network

<b>Title:</b>	<span style="border: 1px solid black; padding: 2px;">☞</span> QoS of pre-established PDP context		
<b>Source:</b>	<span style="border: 1px solid black; padding: 2px;">☞</span> 3GPP TSG_SA WG2		
<b>Work item code:</b>	<span style="border: 1px solid black; padding: 2px;">☞</span> PoC	<b>Date:</b>	<span style="border: 1px solid black; padding: 2px;">☞</span> 26/01/2005
<b>Category:</b>	<span style="border: 1px solid black; padding: 2px;">☞</span> <b>F</b>	<b>Release:</b>	<span style="border: 1px solid black; padding: 2px;">☞</span> Rel-6
	Use <u>one</u> of the following categories: <b>F</b> (correction) <b>A</b> (corresponds to a correction in an earlier release) <b>B</b> (addition of feature), <b>C</b> (functional modification of feature) <b>D</b> (editorial modification) Detailed explanations of the above categories can be found in 3GPP <a href="#">TR 21.900</a> .		Use <u>one</u> of the following releases: <b>Ph2</b> (GSM Phase 2) <b>R96</b> (Release 1996) <b>R97</b> (Release 1997) <b>R98</b> (Release 1998) <b>R99</b> (Release 1999) <b>Rel-4</b> (Release 4) <b>Rel-5</b> (Release 5) <b>Rel-6</b> (Release 6) <b>Rel-7</b> (Release 7)

<b>Reason for change:</b>	<span style="border: 1px solid black; padding: 2px;">☞</span> The TR contains a FFS related to allowed QoS of pre-established PDP contexts.
<b>Summary of change:</b>	<span style="border: 1px solid black; padding: 2px;">☞</span> It is clarified that a pre-established PDP context may have a higher QoS than best effort if subscription and operator policy allows it.
<b>Consequences if not approved:</b>	<span style="border: 1px solid black; padding: 2px;">☞</span> Not clear whether a pre-established PDP context is allowed to have a higher QoS than best effort.

<b>Clauses affected:</b>	<span style="border: 1px solid black; padding: 2px;">☞</span> 5.3.2.2, 5.3.2.3, 5.3.3.2, 5.3.3.3										
<b>Other specs affected:</b>	<table border="1" style="display: inline-table; border-collapse: collapse;"> <tr> <td style="width: 20px; text-align: center;">Y</td> <td style="width: 20px; text-align: center;">N</td> </tr> <tr> <td style="text-align: center;">☞</td> <td style="text-align: center;">X</td> </tr> <tr> <td style="text-align: center;">☞</td> <td style="text-align: center;">X</td> </tr> <tr> <td style="text-align: center;">☞</td> <td style="text-align: center;">X</td> </tr> </table> Other core specifications <span style="border: 1px solid black; padding: 2px;">☞</span>	Y	N	☞	X	☞	X	☞	X		
Y	N										
☞	X										
☞	X										
☞	X										
<b>Other comments:</b>	<span style="border: 1px solid black; padding: 2px;">☞</span>										

**How to create CRs using this form:**

Comprehensive information and tips about how to create CRs can be found at <http://www.3gpp.org/specs/CR.htm>. Below is a brief summary:

- 1) Fill out the above form. The symbols above marked ☞ contain pop-up help information about the field that they are closest to.
- 2) Obtain the latest version for the release of the specification to which the change is proposed. Use the MS Word "revision marks" feature (also known as "track changes") when making the changes. All 3GPP specifications can be downloaded from the 3GPP server under <ftp://ftp.3gpp.org/specs/> For the latest version, look for the directory name with the latest date e.g. 2001-03 contains the specifications resulting from the March 2001 TSG meetings.

- 3) With "track changes" disabled, paste the entire CR form (use CTRL-A to select it) into the specification just in front of the clause containing the first piece of changed text. Delete those parts of the specification which are not relevant to the change request.

### 5.3.2.2 On-demand session with automatic answer

A simplified PoC session flow for on-demand session with automatic answer is shown below when using GPRS bearer. The flow shows a general case and relation of PDP context with PoC/IMS session and does not show any special order or requirement of whether separate PDP context is required for the media or not.

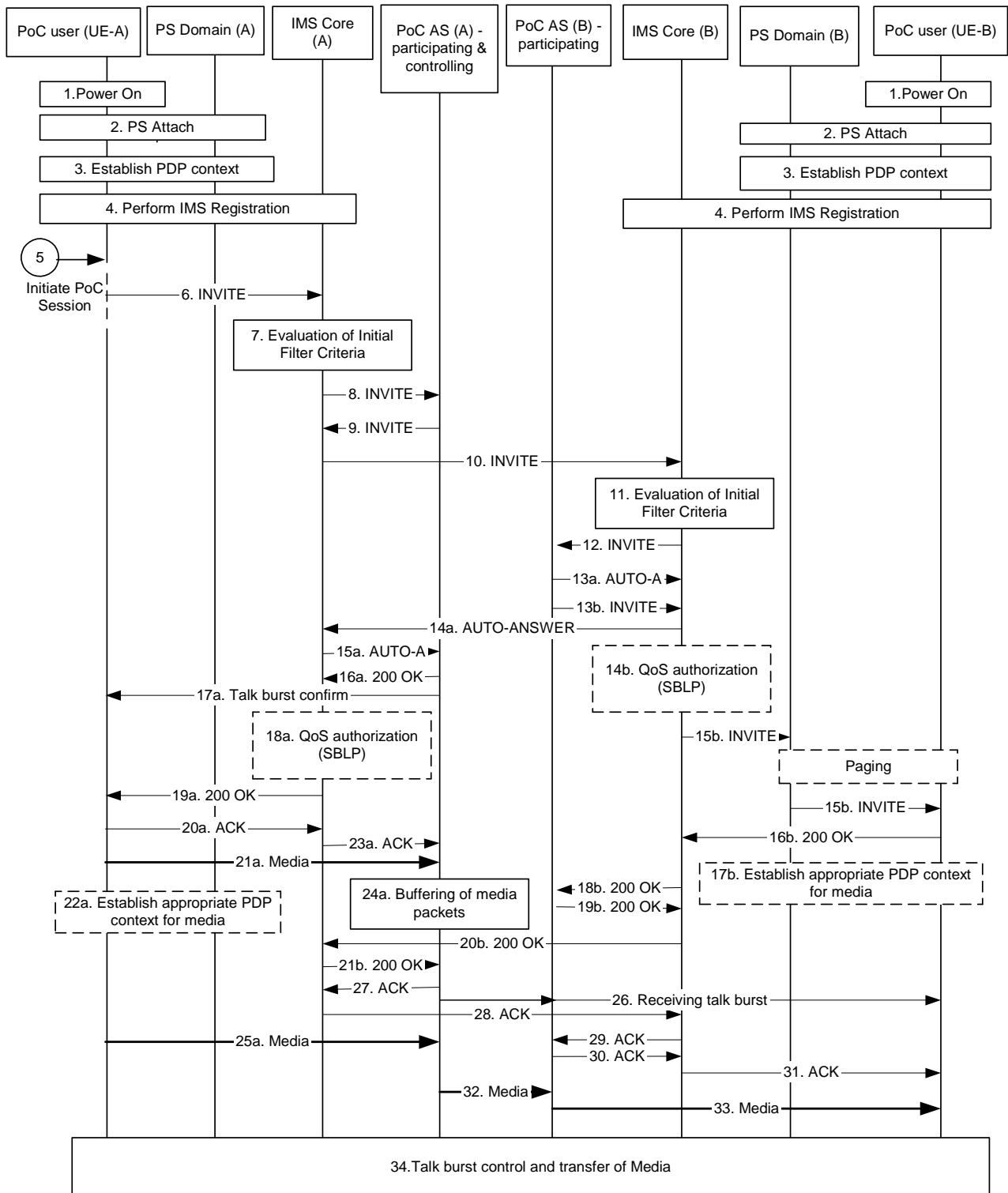

### Figure 5.3.1 On-demand signalling with automatic answering

The simplified steps for establishing PoC communication based upon on demand signalling with auto answering are:

1. Each UE is powered on.
2. Each UE performs PS attach in order to register to the PS domain.
3. Each UE ensures that a PDP context suitable for IMS related signalling is established and if necessary an additional general-purpose PDP context with the same APN and IP address as the PDP context for IMS related signalling..  
Note: This may occur at different times for each terminal. The use of the PDP context bearer(s) depends on how the terminal, network and overall system are configured to operate. Detailed implications of such scenarios will be further analysed in clause 5.4 and clause 6.

If allowed by the subscription and operator policy (see subclause 5.4.3) ~~It is FFS whether~~ the QoS of a pre-established PDP context for PoC talk burst control and media is allowed to have a higher QoS than best effort.

4. Each UE performs the IMS registration
5. User A presses the push-to-talk indication/button on the terminal A to indicate that he wishes to communicate with the user at UE B.

Note that step 5 can occur anytime after step 4 has been performed, there is no timing correlation between these steps once steps 1-4 has been performed.

6. UE-A creates a SIP session for the PoC communication by sending the INVITE request into the IMS Core (A), in this example with UE-B as a destination address (alternatively the destination address could also be a PSI hosted by a PoC server for a PoC group session). The INVITE request contains the PoC service indication and the SDP media parameters indicate the IP address obtained in step 3 and that UE-A is ready to send and receive media, as in this example the UE-A established a non real time PDP context for talk burst control and media at IMS registration time.
- 7-8 The IMS core A identifies that the service indication matches ISC filtering information and routes the INVITE request to the PoC AS (A).
- 9-107. PoC AS (A) (after determining that the PoC communication should be completed), together with the IMS Core (A), forwards the INVITE request towards the IMS Core (B).
- 11-12. The IMS Core (B) identifies that the service indication matches ISC filtering information and routes the INVITE request to the PoC AS (B).
- 13a. PoC AS (B) sends AUTO-ANSWER to PoC AS (A) as user B is accepting the session automatically
- 13b. The PoC AS (B) forwards the INVITE request to UE-B via IMS Core (B)
- 14a-15a. The IMS Core (B) forwards the AUTO-ANSWER message towards the PoC AS (A) via IMS Core (A)
- 16a-17a. Based on the AUTO-ANSWER and that the PoC AS (A) supports buffering of media, the PoC AS (A) sends a 200 OK towards the UE-A and at the same time sends a talk burst confirm to UE-A. The talk burst control message is transferred to UE-A on a PDP contexts established in step 3.
- 18a-19a. In case Service Based Local Policy is applied in UE A's network, IMS Core (A) generates an authorization token for the session, inserts and delivers the authorization token to the UE-A in the first available reliable SIP response (in this case the 200 OK).
- 20a-22a. After the UE-A received both the 200 OK response and the talk burst confirm message, UE-A may send media data to PoC AS (A) using a PDP context established in step 3. The UE-A acknowledges the 200 OK. UE-A may establish an additional PDP context for media and talk burst control exchange with same IP address and APN as of the PDP contexts of step 3, e.g. a PDP context with traffic class streaming and bandwidth required for the negotiated media parameters. If the UE received an authorization token in step 19a, it inserts it in the PDP context signalling.
- 23a. The IMS Core (A) forwards the acknowledgement to PoC AS (A)



- 24a. The PoC AS (A) buffers the received media until a positive response from UE-B is received
- 25a. UE-A continues sending media. If and when the PDP context established in step 22a is available, UE-A uses it.
- 14b-15b. In case Service Based Local Policy is applied in UE B's network, IMS Core (B) generates an authorization token for the session, and inserts and delivers the authorization token in the INVITE request to UE-B.

Typically UE-B needs to be paged before the INVITE request can be transferred.

Note: The INVITE message is transparent to the PS Domain.

- 16b-17b After receiving the INVITE request, UE (B) accepts the session by returning 200 OK. The media parameters indicate the IP address obtained in step 3. UE B may establish an additional PDP context for media and talk burst control exchange with same IP address and APN as of the context of step 3, e.g. a PDP context with traffic class streaming and bandwidth required for the negotiated media parameters. If the UE received an authorization token in step 15b, it inserts it in the PDP context signalling.
- 18b-21b. IMS Core (B) forwards the 200 OK to the PoC AS (B), which forwards the 200 OK towards the PoC AS (A) via IMS Core (B) and IMS Core (A).
- 26. PoC AS (A) inform the UE-B via the PoC AS (B) that receiving talk bursts from UE-A are on the way.
- 27-29. The PoC AS (A) acknowledges the session set-up, the acknowledgement traverses to PoC AS (B) via IMS Core (A) and IMS Core (B).
- 30-31. The PoC AS (B) acknowledges the session set-up
- 32. The buffered media is transferred from PoC AS (A) to PoC AS (B).
- 33. PoC AS (B) transfer the media to UE-B. If and when the PDP context established in step 17b is available, it is used for this purpose
- 34. Further media and talk burst control messages are transferred between the involved entities.

### 5.3.2.3 On demand session with manual answer

A simplified PoC session flow for on-demand session with manual answer is shown below when using GPRS bearer. The flow shows a general case and relation of PDP context with PoC/IMS session and does not show any special order or requirement of whether separate PDP context is required for the media or not.

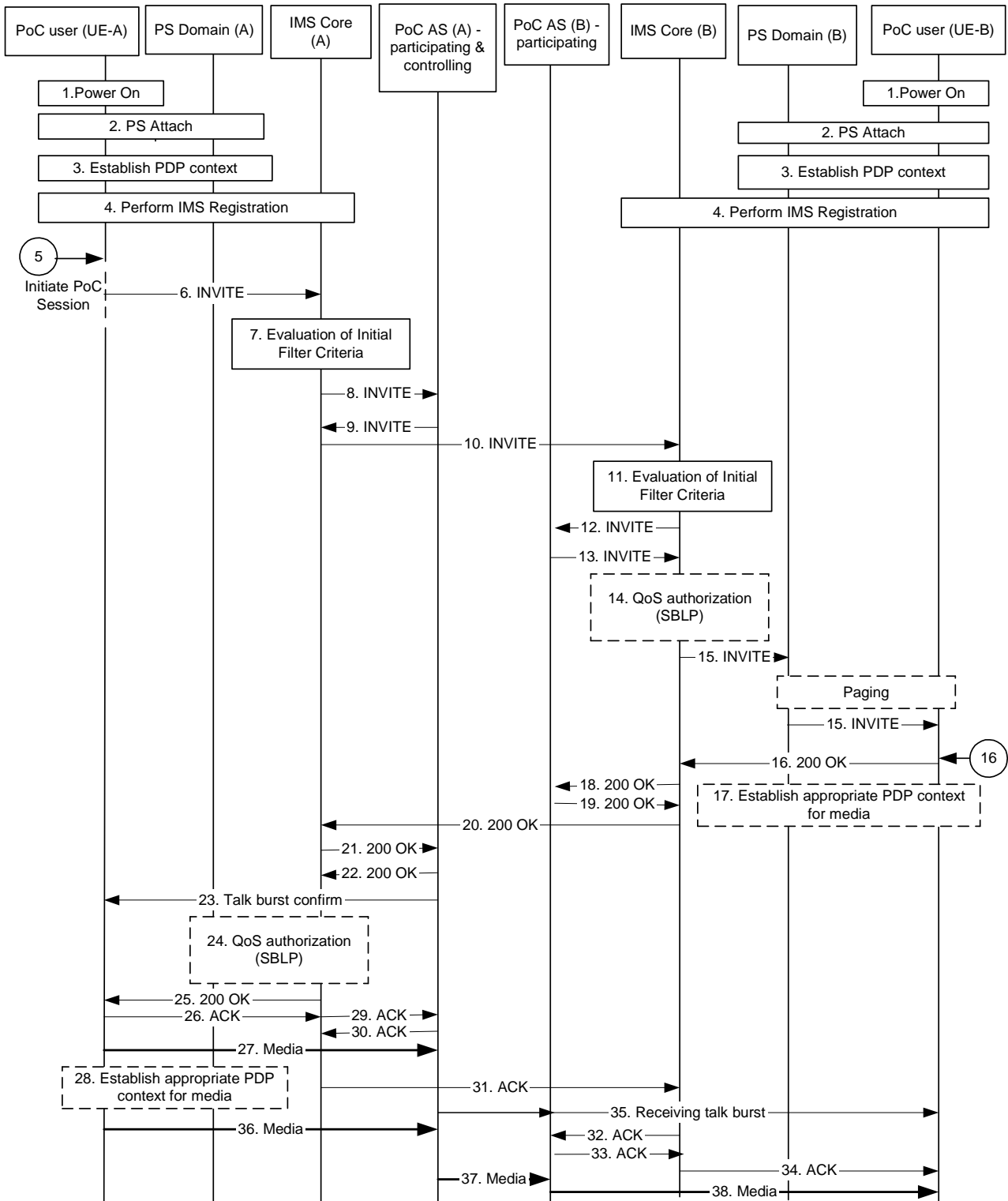

**Figure 5.3.2 On-demand signalling with manual answer**

The simplified steps for establishing PoC communication based upon on demand signalling with manual answering are:

1. Each UE is powered on.
2. Each UE performs PS attach in order to register to the PS domain.
3. Each UE ensures that a PDP context suitable for IMS related signalling is established and if necessary an additional general purpose PDP context with the same APN and IP address as the PDP context for IMS related signalling.

Note: This may occur at different times for each terminal. The use of the PDP context bearer(s) depends on how the terminal, network and overall system are configured to operate. Detailed implications of such scenarios will be further analysed in subclause 5.4 and clause 6.

If allowed by the subscription and operator policy (see subclause 5.4.3) ~~It is FFS whether~~ the QoS of a pre-established PDP context for PoC talk burst control and media is allowed to have a higher QoS than best effort.

4. Each UE performs the IMS registration
5. User A presses the push-to-talk indication/button on the UE A to indicate that he wishes to communicate with the user at UE B.

Note that step 5 can occur anytime after step 4 has been performed, there is no timing correlation between these steps once steps 1-4 has been performed.

6. UE-A creates a SIP session for the PoC communication by sending the INVITE request into the IMS Core (A), in this example with UE-B as a destination address (alternatively the destination address could also be a PSI hosted by a PoC server for a PoC group session). The INVITE request contains the PoC service indication and the SDP media parameters indicate the IP address obtained in step 3 and that UE-A is ready to send and receive media, as in this example the UE-A established a non real time PDP context for talk burst control and media at IMS registration time.
- 7-8. The IMS Core (A) identifies that the service indication matches ISC filtering information and routes the INVITE request to the PoC AS (A).
- 9-10. PoC AS (A) (after determining that the PoC communication should be completed), together with the IMS Core (A), forwards the INVITE request towards the IMS Core (B).
- 11-12. The IMS Core (B) identifies that the service indication matches ISC filtering information and routes the INVITE request to the PoC AS (B).
13. The PoC AS (B) forwards the INVITE request to UE-B via IMS Core (B)
- 14-15. In case Service Based Local Policy is applied in UE B's network, IMS Core (B) generates an authorization token for the session, and inserts and delivers the authorization token in the INVITE request to UE-B.

Typically UE-B needs to be paged before the INVITE request can be transferred.

Note: The INVITE message is transparent to the PS domain.

- 16-17. After receiving the INVITE request, user (B) accepts the session set-up manually and UE-B accepts the session by returning 200 OK. UE-B should send a 180 ringing response when receiving the INVITE request to avoid the INVITE request to be re-sent (not shown in the figure). The media parameters indicate the IP address obtained in step 3. UE B may establish an additional PDP context for media and talk burst control exchange with same IP address and APN as of the context of step 3, e.g. a PDP context with traffic class streaming and bandwidth required for the negotiated media parameters. If the UE-B received an authorization token in step 15, it inserts it in the PDP context signalling.
- 18-21. IMS Core (B) forwards the 200 OK to the PoC AS (B), which forwards the 200 OK towards the PoC AS (A) via IMS Core (B) and IMS Core (A).
- 22-23. PoC AS (A) sends a 200 OK towards the UE-A and at the same time sends a talk burst confirm to UE-A.
- 24-25. In case Service Based Local Policy is applied in UE A's network, IMS Core (A) generates an authorization token for the session, inserts and delivers the authorization token to the UE-A in the first available reliable SIP response (in this case the 200 OK).
- 26-28. After the UE-A received both the 200 OK response and the talk burst confirm message, UE-A may send media data to PoC AS (A) using a PDP context established in step 3. The UE-A acknowledges the 200 OK. UE-A may establish an additional PDP context for media and talk burst control exchange with same IP address and APN as of the PDP contexts of step 3, e.g. a PDP context with traffic class

streaming and bandwidth required for the negotiated media parameters. If the UE received an authorization token in step 25, it inserts it in the PDP context signalling.

29. The IMS Core (A) forwards the acknowledgement to PoC AS (A)
- 30-32. The PoC AS (A) acknowledges the session set-up, the acknowledgement traverses to PoC AS (B) via IMS Core (A) and IMS Core (B).
- 33-34. The PoC AS (B) acknowledges the session set-up
35. PoC AS (A) inform the UE-B via the PoC AS (B) that receiving talk bursts from UE-A are on the way.
36. UE-A continues sending media. If and when the PDP context established in step 28 is available, UE-A uses it.
- 37-38. PoC AS (A) transfer the media to UE-B, via PoC AS (B). If and when the PDP context established in step 17 is available, it is used for this purpose

### 5.3.3 Pre-established Session

#### 5.3.3.1 Pre-established session general

For a pre-established PoC session, media parameters are negotiated at the setup of the pre-established PoC session and during the PoC session is setup the media parameter negotiation can be skipped. Two types of pre-established session set-up procedures are described below.

#### 5.3.3.2 Pre-established session with automatic answer

A simplified PoC session flow for the setup of session having pre-established session with automatic answer is shown below when using GPRS bearer. The flow shows a general case and relation of PDP context with PoC/IMS session and does not show any special order or requirement of whether separate PDP context is required for the media or not. This flow assumes (though it is not required for both sides to use the same mechanism) that both originating and terminating PoC user uses the Pre-established session mechanism.

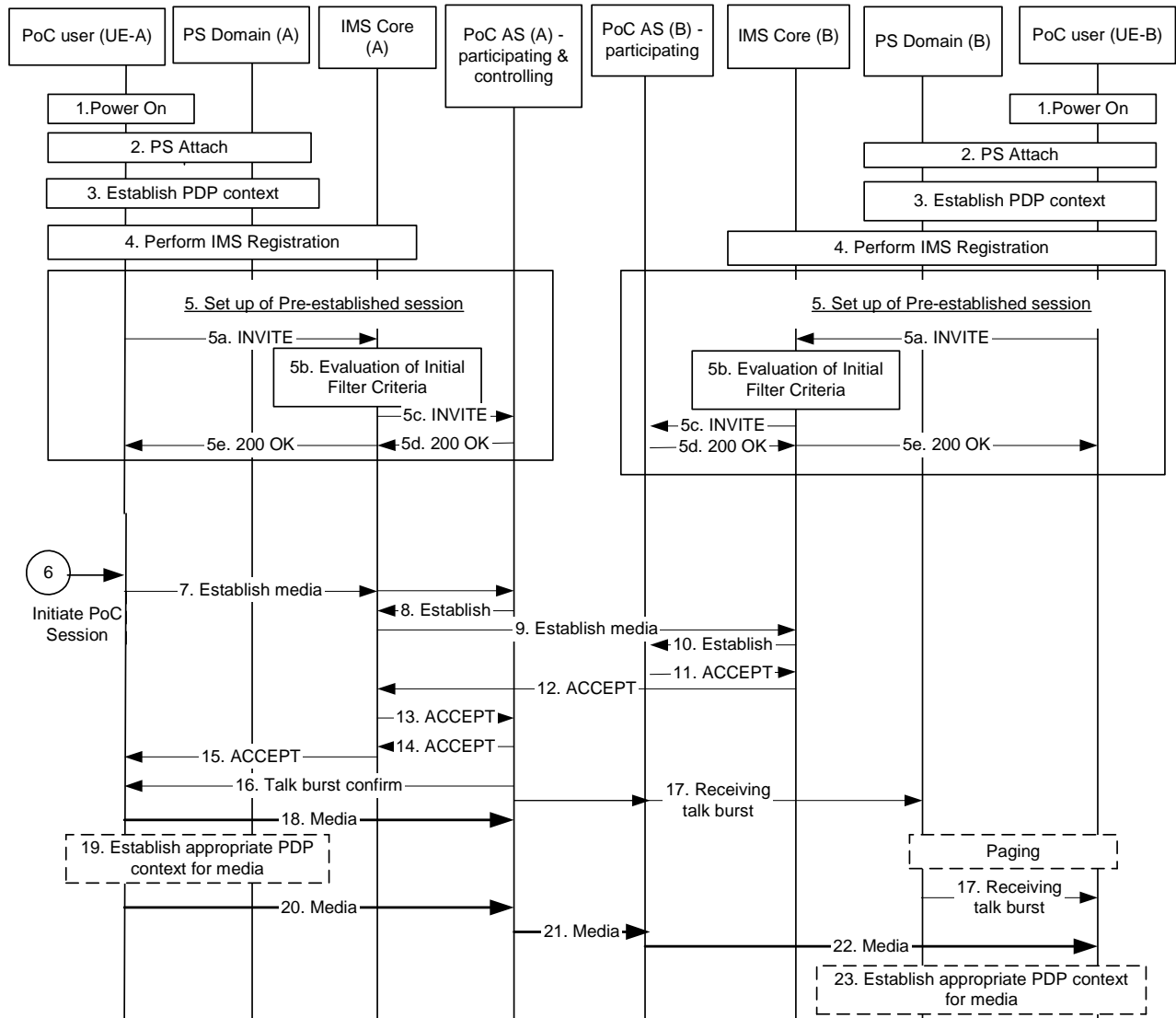

**Figure 5.3.3 Pre-established session signalling with automatic answering**

The simplified steps for establishing PoC communication based upon pre-established session signalling are:

1. Each terminal is powered on.
2. Each terminal performs PS attach in order to authenticate to the PS domain.
3. Each UE ensures that a PDP context suitable for IMS related signalling is established and if necessary an additional general purpose PDP context with the same APN and IP address as the PDP context for IMS related signalling.

Note: This may occur at different times for each terminal. The use of the PDP context bearer(s) depends on how the terminal, network and overall system are configured to operate. Detailed implications of such scenarios will be further analysed in subclause 5.4 and clause 6.

[If allowed by the subscription and operator policy \(see subclause 5.4.3\)](#) ~~It is FFS whether~~ the QoS of a pre-established PDP context for PoC talk burst control and media is allowed to have a higher QoS than best effort

4. Each terminal performs the IMS registration
5. Each terminal establishes the pre-established session for PoC communication towards the PoC AS (e.g. by using a dedicated PSI). The INVITE request contains the PoC service indication and the SDP media parameters indicate the IP address obtained in step 3; the IMS Core (A) identifies that this service

indication matches ISC filtering information and routes the session establishment request to the PoC AS (A).

In case Service Based Local Policy is applied in the UE(A)'s IMS network, IMS Core (A) generates an authorization token for the session, inserts and delivers the authorization token to the UE-A upon set-up of the pre-established session (in the 200OK response).

Note: This pre-established session set-up may occur at different times for each terminal. Once the session relationship is established, it remains as long as the user wishes to remain connected to the PoC server. Implications of such long established session and its relationship with other IMS functions will require further study.

6. User A presses the push-to-talk indication/button on the terminal A to indicate that he wishes to communicate to the user at UE (B).
- 7-10. UE-A request the establishment of media transfer and sends, for example, a SIP REFER message to the PoC AS (A) via the IMS Core (A), containing the address of the terminating user. PoC AS (A) sends the message to PoC AS (B) by means of IMS core (A) and IMS Core (B).
- 11-13. PoC AS (B) accepts the session initiation to PoC AS (A), via IMS Core (B) and IMS Core (A).
- 14-16. The PoC AS (A) acknowledges the media establishment request message and at the same time sends a talk burst confirm to UE-A. The talk burst control message is transferred to UE-A on a PDP contexts established in step 3.
17. PoC AS (A) inform the UE-B via the PoC AS (B) that receiving talk bursts from UE-A are on the way.

Typically UE-B needs to be paged before the Receiving talk burst message can be transferred

Note: The Receiving talk burst message is transparent to the PS Domain.

- 18-19. After the UE-A received both the acknowledgement for the media establishment request message and the talk burst confirm message, UE-A may send media data to PoC AS (A). UE-A may establish an additional PDP context for media and talk burst control exchange with same IP address and APN as of the PDP contexts of step 3, e.g. a PDP context with traffic class streaming and bandwidth required for the negotiated media parameters. If the UE received an authorization token in step 5, it inserts it in the PDP context signalling. As soon as the PDP context established in step 18 is available, UE-A uses it.
- 20-22. UE-A continues sending media. If and when the PDP context established in step 19 is available, UE-A uses it. UE-A sends the media data to PoC AS (A), which sends media data to UE-B, via PoC AS (B).
23. Having received the receiving talk burst message, UE-B may establish an additional PDP context for media and talk burst control exchange with same IP address and APN as of the context(s) of step 3, e.g. a PDP context with traffic class streaming and bandwidth required for the negotiated media parameters. If the UE received an authorization token in step 5, it inserts it in the PDP context signalling.

### 5.3.3.3 Pre-established session with manual answer

A simplified PoC session flow for the setup of session having pre-established session with manual answer is shown below when using GPRS bearer. The flow shows a general case and relation of PDP context with PoC/IMS session and does not show any special order or requirement of whether separate PDP context is required for the media or not. This flow assumes (though it is not required for both sides to use the same mechanism) that both originating and terminating PoC user uses the Pre-established session mechanism.

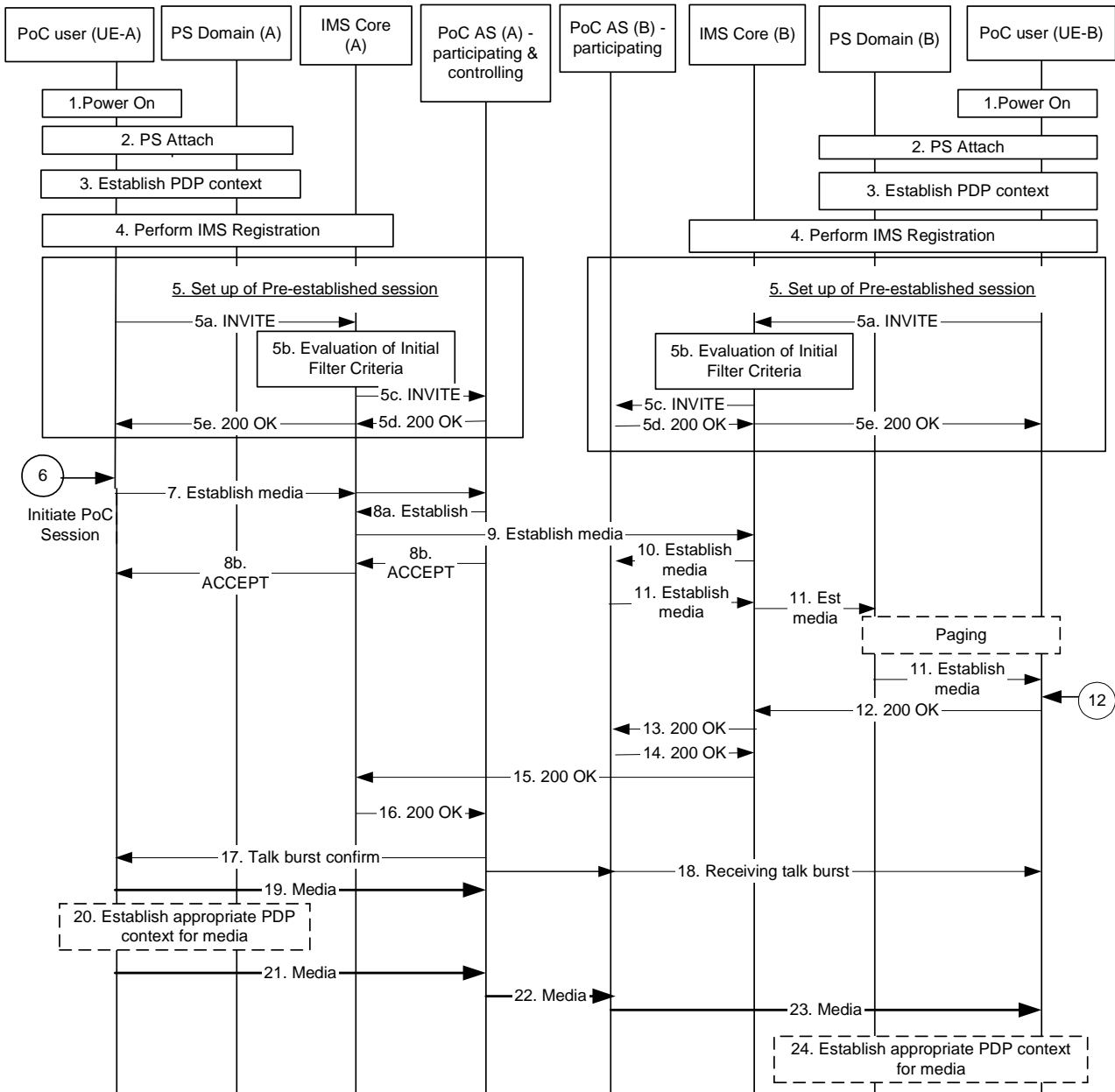

Figure 5.3.4 Pre-established session handling with manual answer

The simplified steps for establishing PoC communication based upon pre-established session signalling are:

1. Each terminal is powered on.
2. Each terminal performs PS attach in order to authenticate to the PS domain.
3. Each UE ensures that a PDP context suitable for IMS related signalling is established and if necessary an additional general purpose PDP context with the same APN and IP address as the PDP context for IMS related signalling.  
 Note: This may occur at different times for each terminal. The use of the PDP context bearer(s) depends on how the terminal, network and overall system are configured to operate. Detailed implications of such scenarios will be further analysed in subclause 5.4 and clause 6.

If allowed by the subscription and operator policy (see subclause 5.4.3) ~~It is FFS whether~~ the QoS of a pre-established PDP context for PoC talk burst control and media is allowed to have a higher QoS than best effort

4. Each terminal performs the IMS registration

5. Each terminal establishes the pre-established session for PoC communication towards the PoC AS (e.g. by using a dedicated PSI). The INVITE request contains the PoC service indication and the SDP media parameters indicate the IP address obtained in step 3; the IMS Core (A) identifies that this service indication matches ISC filtering information and routes the session establishment request to the PoC AS (A).

In case Service Based Local Policy is applied in the UE(A)'s IMS network, IMS Core (A) generates an authorization token for the session, inserts and delivers the authorization token to the UE-A upon set-up of the pre-established session (in the 200OK response).

Note: This pre-established session set-up may occur at different times for each terminal. Once the session relationship is established, it remains as long as the user wishes to remain connected to the PoC server. Implications of such long established session and its relationship with other IMS functions will require further study.

6. User A presses the push-to-talk indication/button on the terminal A to indicate that he wishes to communicate to the user at UE (B).
7. UE-A requests the establishment of media transfer and sends, for example, a SIP REFER message to the PoC AS (A) via the IMS Core (A), containing the address of the terminating user.
- 8a-10. PoC AS (A) sends the INVITE message to PoC AS (B) by means of IMS core (A) and IMS Core (B).
- 8b. PoC AS (A) sends ACCEPT message to UE-A via IMS core (A).
11. The PoC AS (B) requests the establishment of media transfer and sends, for example, a SIP re-INVITE message to the UE (B) via the IMS Core (B).

Typically UE-B needs to be paged before the SIP re-INVITE message can be transferred.

Note: The re-INVITE message is transparent to the PS Domain

12. After receiving the re-INVITE request, user (B) accepts the session set-up manually and UE-B accepts the session by returning 200 OK. UE-B should send a 180 ringing response when receiving the INVITE request to avoid the re-INVITE request to be re-sent (not shown in the figure). The media parameters indicate the IP address obtained in step 3.
- 13-16. IMS Core (B) forwards the 200 OK to the PoC AS (B), which forwards the 200 OK towards the PoC AS (A) via IMS Core (B) and IMS Core (A).
17. The PoC AS (A) sends a talk burst confirm to UE-A. The talk burst control message is transferred to UE-A on a PDP contexts established in step 3.
18. PoC AS (A) informs the UE-B via the PoC AS (B) that receiving talk bursts from UE-A are on the way.
- 19-20. After the UE-A received both the acknowledgement for the media establishment request message and the talk burst confirm message, UE-A may send media data to PoC AS (A). UE-A may establish an additional PDP context for media and talk burst control exchange with same IP address and APN as of the PDP contexts of step 3, e.g. a PDP context with traffic class streaming and bandwidth required for the negotiated media parameters. If the UE received an authorization token in step 5, it inserts it in the PDP context signalling. As soon as the PDP context established in step 20 is available, UE-A uses it.
- 21-23. UE-A continues sending media. If and when the PDP context established in step 20 is available, UE-A uses it. UE-A sends the media data to PoC AS (A), which sends media data to UE-B, via PoC AS (B).
24. Having received the receiving talk burst message, UE-B may establish an additional PDP context for media and talk burst control exchange with same IP address and APN as of the context(s) of step 3, e.g. a PDP context with traffic class streaming and bandwidth required for the negotiated media parameters. If the UE received an authorization token in step 5, it inserts it in the PDP context signalling.



## CHANGE REQUEST

☞ **23.979 CR 003** ☞ rev **1** ☞ Current version: **6.0.0** ☞

For **HELP** on using this form, see bottom of this page or look at the pop-up text over the ☞ symbols.

**Proposed change affects:** | UICC apps  ME  Radio Access Network  Core Network

<b>Title:</b>	<span>☞</span> Alignment of 23.979 with OMA architecture		
<b>Source:</b>	<span>☞</span> 3GPP TSG_SA WG2		
<b>Work item code:</b>	<span>☞</span> PoC	<b>Date:</b>	<span>☞</span> 20/01/2005
<b>Category:</b>	<span>☞</span> <b>F</b>	<b>Release:</b>	<span>☞</span> Rel-6
	Use <u>one</u> of the following categories: <b>F</b> (correction) <b>A</b> (corresponds to a correction in an earlier release) <b>B</b> (addition of feature), <b>C</b> (functional modification of feature) <b>D</b> (editorial modification) Detailed explanations of the above categories can be found in 3GPP <a href="#">TR 21.900</a> .		Use <u>one</u> of the following releases: <b>Ph2</b> (GSM Phase 2) <b>R96</b> (Release 1996) <b>R97</b> (Release 1997) <b>R98</b> (Release 1998) <b>R99</b> (Release 1999) <b>Rel-4</b> (Release 4) <b>Rel-5</b> (Release 5) <b>Rel-6</b> (Release 6) <b>Rel-7</b> (Release 7)

<b>Reason for change:</b>	<span>☞</span> 23.979 still includes GLMS in the architecture and contains some errors in some flows
<b>Summary of change:</b>	<span>☞</span> This CR replaces GLMS with XDMS and corrects PoC Flows in alignment with OMA specifications
<b>Consequences if not approved:</b>	<span>☞</span> Confusion due to misalignment of 3GPP and OMA documents

<b>Clauses affected:</b>	<span>☞</span> 3.2,5.1, 5.2.1, 5.3.3.2, 5.3.3.3, B.4						
<b>Other specs affected:</b>	<table border="1" style="display: inline-table; border-collapse: collapse;"> <tr> <td style="width: 20px; text-align: center;">Y</td> <td style="width: 20px; text-align: center;">N</td> </tr> <tr> <td style="text-align: center;"><input checked="" type="checkbox"/></td> <td style="text-align: center;"><input checked="" type="checkbox"/></td> </tr> </table> Other core specifications <span>☞</span>	Y	N	<input checked="" type="checkbox"/>	<input checked="" type="checkbox"/>		
Y	N						
<input checked="" type="checkbox"/>	<input checked="" type="checkbox"/>						
	<table border="1" style="display: inline-table; border-collapse: collapse;"> <tr> <td style="width: 20px; text-align: center;">X</td> </tr> <tr> <td style="text-align: center;"><input checked="" type="checkbox"/></td> </tr> </table> Test specifications	X	<input checked="" type="checkbox"/>				
X							
<input checked="" type="checkbox"/>							
	<table border="1" style="display: inline-table; border-collapse: collapse;"> <tr> <td style="width: 20px; text-align: center;">X</td> </tr> <tr> <td style="text-align: center;"><input checked="" type="checkbox"/></td> </tr> </table> O&M Specifications	X	<input checked="" type="checkbox"/>				
X							
<input checked="" type="checkbox"/>							
<b>Other comments:</b>	<span>☞</span>						

### How to create CRs using this form:

Comprehensive information and tips about how to create CRs can be found at <http://www.3gpp.org/specs/CR.htm>. Below is a brief summary:

- 1) Fill out the above form. The symbols above marked ☞ contain pop-up help information about the field that they are closest to.
- 2) Obtain the latest version for the release of the specification to which the change is proposed. Use the MS Word "revision marks" feature (also known as "track changes") when making the changes. All 3GPP specifications can be

downloaded from the 3GPP server under <ftp://ftp.3gpp.org/specs/> For the latest version, look for the directory name with the latest date e.g. 2001-03 contains the specifications resulting from the March 2001 TSG meetings.

- 3) With "track changes" disabled, paste the entire CR form (use CTRL-A to select it) into the specification just in front of the clause containing the first piece of changed text. Delete those parts of the specification which are not relevant to the change request.

## 3.2 Abbreviations

For the purposes of the present document, the following abbreviations apply:

CSCF	Call Session Control Function
<del>GLMS</del>	<del>Group and List Management Server</del>
PoC	Push to talk over Cellular
I-CSCF	Interrogating-CSCF
IMS	IP Multimedia Subsystem
IP	Internet Protocol
P-CSCF	Proxy-CSCF
S-CSCF	Serving-CSCF
SBLP	Service Based Local Policy
UE	User Equipment
<u>XDMS</u>	<u>XML Document Management Server</u>

---

# 5 Architectural Concept

## 5.1 General overview

PoC service is introduced as an application within the frame of the IP Multimedia Subsystem (IMS). Figure 5.1 below illustrates how the PoC service elements fit into the IMS architecture.

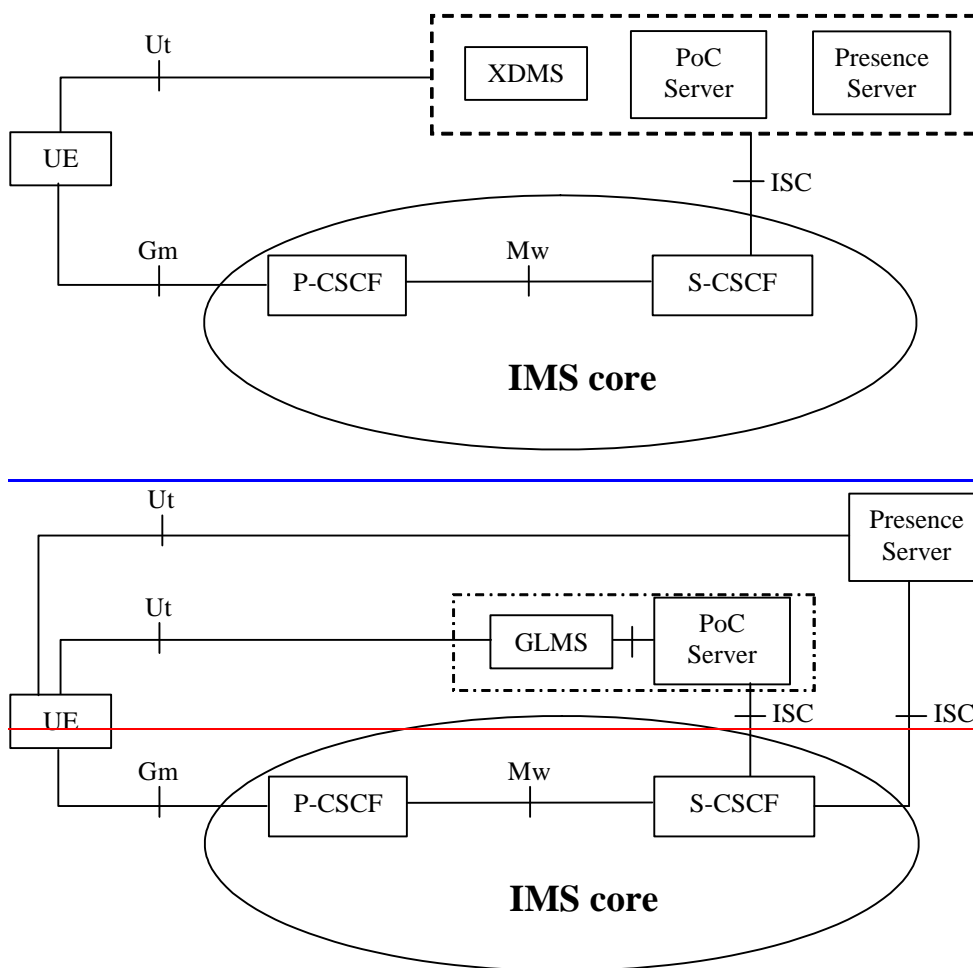

**Figure 5-1. PoC service elements in the IMS architecture**

Note: The I-CSCF is not shown in Figure 5-1 for the sake of simplicity. [Application servers \(XDMS, PoC Server, Presence Server\), and interfaces between these application servers shown within the dotted box in Figure 5-1 are defined by OMA.](#)

The OMA PoC architecture specification [6] leverages IMS as the underlying SIP-based IP-core network. To understand the details of how IMS capabilities relate to the overall PoC architecture, there is a need to map the reference points defined in the OMA PoC specification [6], and the reference points defined in 3GPP TS 23.002 [3] and 3GPP TS 23.228 [4].

The PoC server implementing the application level network functionality for the PoC service is essentially seen as an Application Server from the IMS perspective. Consequently, communications between the IMS core and the PoC server utilize the ISC interface defined in 3GPP TS 23.228 [4].

As defined by [6], the ~~Group and List~~XML Document Management Server (~~GLMS~~~~XDMS~~) is used by the PoC users to manage groups and lists (e.g. contact and access lists) that are needed for the PoC service. In the IMS architecture, the Ut interface provides these functions, hence communications between the ~~GLMS~~~~XDMS~~ and the UE utilize the Ut interface.

As defined by [6], a Presence Server may provide availability information about PoC users to other PoC users. The 3GPP Presence architecture and the Presence Server are defined in TS 23.141 [5].

## 5.2 Architecture assumptions

### 5.2.1 Charging architecture aspects

3GPP TS 32.240 specifies the overall charging architecture for the 3GPP system, including the IMS charging architecture. 3GPP TS 32.260 and 3GPP TS 32.299 specify the IMS charging details, including the S-CSCF's interfaces towards the charging nodes used for session charging.

Based on the IMS charging architecture described in these TSs, and the mapping of IMS and OMA PoC architectures described in Section 5.1, the architecture described in Figure 5-2 below shows the charging interfaces around the PoC server:

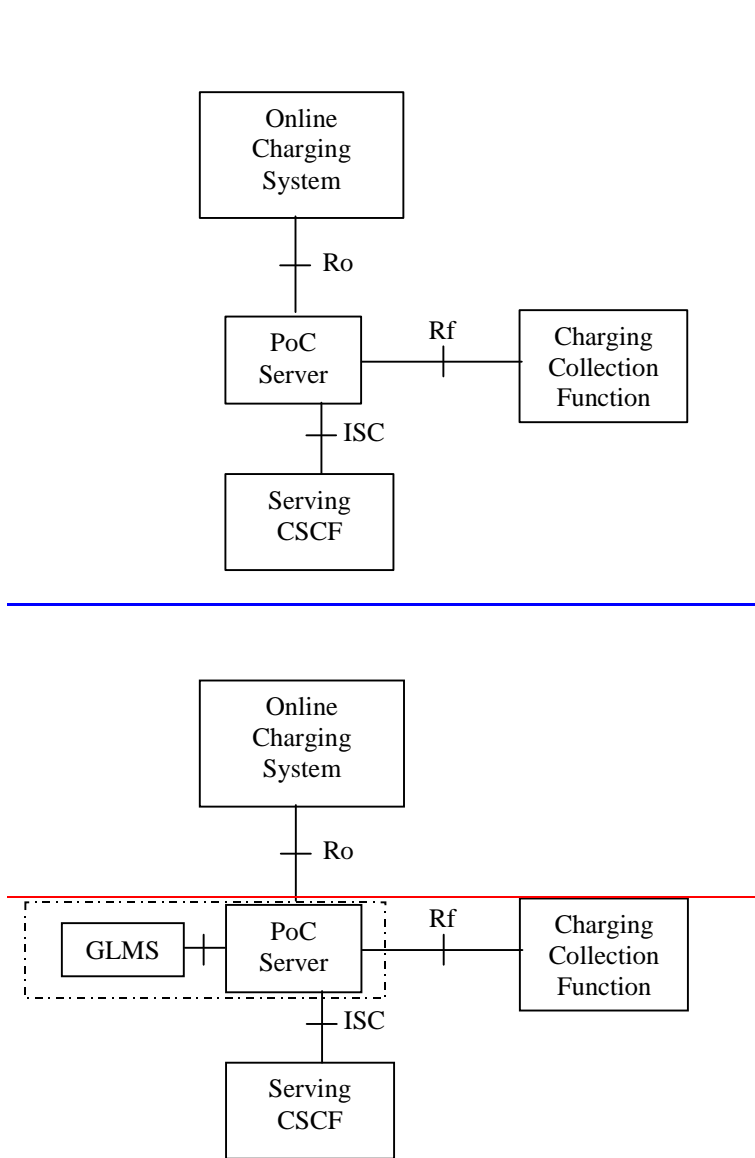

**Figure 5-2 - Architecture for PoC charging**

The Charging Collection Function (CCF) is used for offline charging. It shall be possible for the PoC server to send offline accounting information about PoC-service events to the CCF using the mechanisms described for the Rf interface described in 3GPP TS 32.260. Possible additional accounting information to cover PoC charging requirements shall be fulfilled by extending the Rf interface, if needed.

The address of the CCF to be used by the PoC server for the PoC session is distributed to the PoC server in SIP signaling, as described in 3GPP TS 24.229 [8].

The Online Charging System is used for online charging PoC service-related events. It shall be possible for the PoC server to perform credit control interactions as per the mechanisms defined for the Ro interface. The address of the OCS (same as the address of the ECF) to be used by the PoC server for the PoC session is distributed to the PoC server in SIP signaling.

### 5.3.3.2 Pre-established session with automatic answer

A simplified PoC session flow for the setup of session having pre-established session with automatic answer is shown below when using GPRS bearer. The flow shows a general case and relation of PDP context with PoC/IMS session and does not show any special order or requirement of whether separate PDP context is required for the media or not. This flow assumes (though it is not required for both sides to use the same mechanism) that both originating and terminating PoC user uses the Pre-established session mechanism.

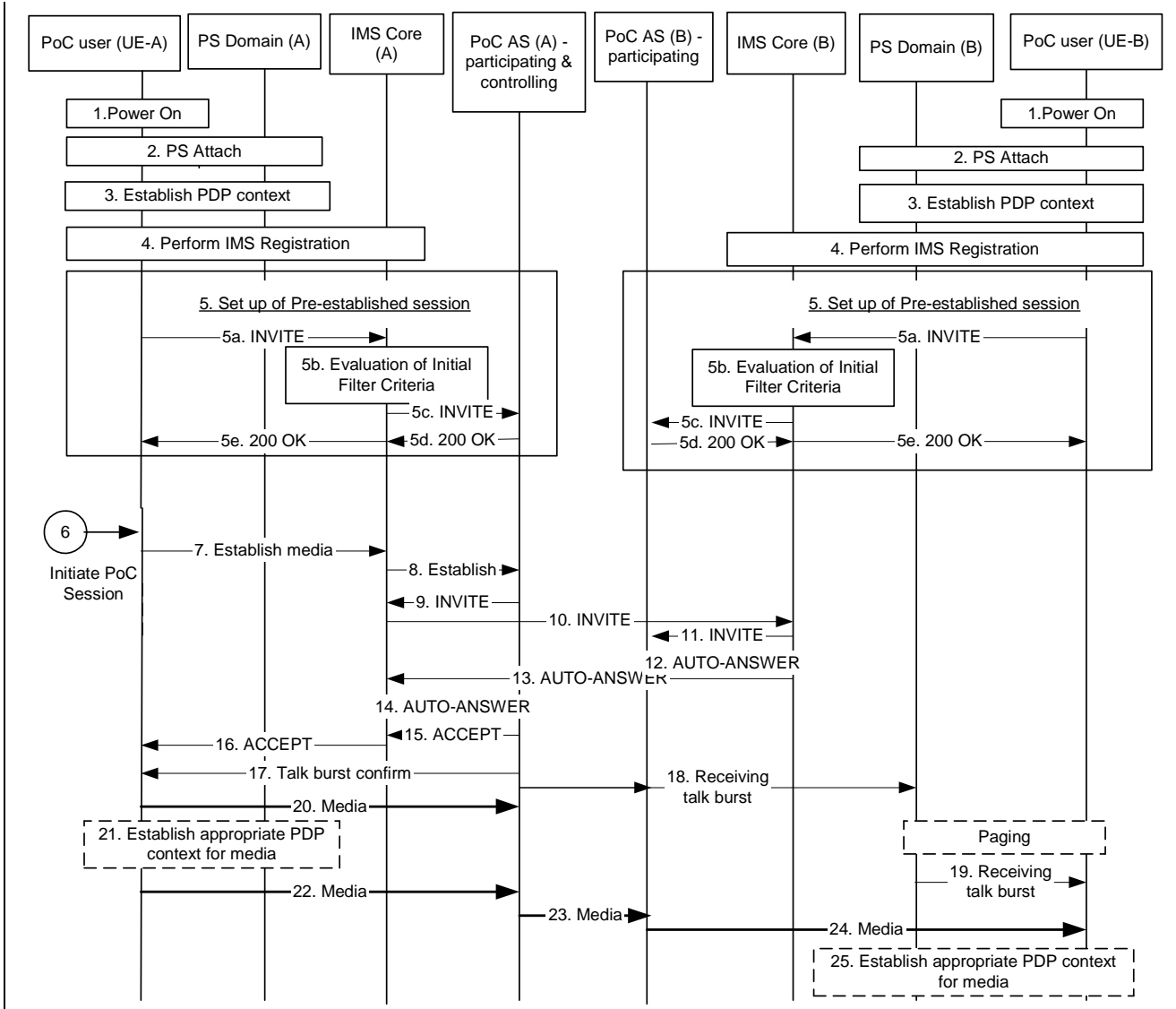

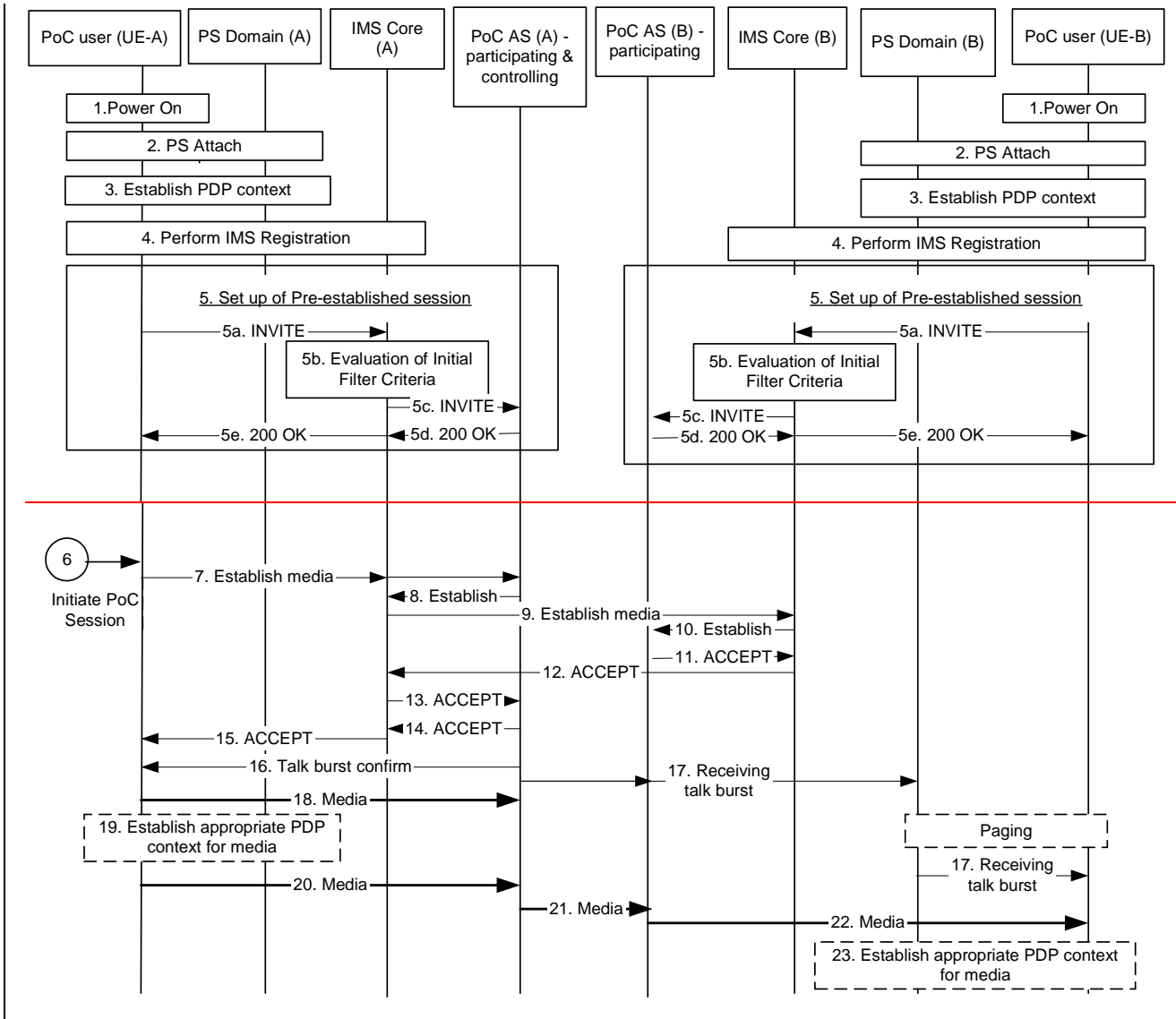

**Figure 5.3.3: Pre-established session signalling with automatic answering**

The simplified steps for establishing PoC communication based upon pre-established session signalling are:

1. Each terminal is powered on.
2. Each terminal performs PS attach in order to authenticate to the PS domain.
3. Each UE ensures that a PDP context suitable for IMS related signalling is established and if necessary an additional general purpose PDP context with the same APN and IP address as the PDP context for IMS related signalling.

Note: This may occur at different times for each terminal. The use of the PDP context bearer(s) depends on how the terminal, network and overall system are configured to operate. Detailed implications of such scenarios will be further analysed in subclause 5.4 and clause 6.

It is FFS whether the QoS of a pre-established PDP context for PoC talk burst control and media is allowed to have a higher QoS than best effort

4. Each terminal performs the IMS registration
5. Each terminal establishes the pre-established session for PoC communication towards the PoC AS (e.g. by using a dedicated PSI). The INVITE request contains the PoC service indication and the SDP media parameters indicate the IP address obtained in step 3; the IMS Core (A) identifies that this service indication matches ISC filtering information and routes the session establishment request to the PoC AS (A).



In case Service Based Local Policy is applied in the UE(A)'s IMS network, IMS Core (A) generates an authorization token for the session, inserts and delivers the authorization token to the UE-A upon set-up of the pre-established session (in the 200OK response).

Note: This pre-established session set-up may occur at different times for each terminal. Once the session relationship is established, it remains as long as the user wishes to remain connected to the PoC server. Implications of such long established session and its relationship with other IMS functions will require further study.

6. User A presses the push-to-talk indication/button on the terminal A to indicate that he wishes to communicate to the user at UE (B).
- ~~7-10~~8. UE-A request the establishment of media transfer and sends, for example, a SIP REFER message to the PoC AS (A) via the IMS Core (A), containing the address of the terminating user.
- 9-11. PoC AS (A) sends ~~the message~~an INVITE request to PoC AS (B) by means of IMS core (A) and IMS Core (B).
- ~~11-12-13~~14. PoC AS (B) ~~accepts the session initiation~~indicates Auto-Answer to PoC AS (A), via IMS Core (B) and IMS Core (A).
- ~~14-15-16~~17. The PoC AS (A) acknowledges the media establishment request message and at the same time sends a talk burst confirm to UE-A. The talk burst control message is transferred to UE-A on a PDP contexts established in step 3.
- 18-19~~7~~. PoC AS (A) inform the UE-B via the PoC AS (B) that receiving talk bursts from UE-A are on the way.  
Typically UE-B needs to be paged before the Receiving talk burst message can be transferred  
Note: The Receiving talk burst message is transparent to the PS Domain.
- ~~18-19~~20-21. After the UE-A received both the acknowledgement for the media establishment request message and the talk burst confirm message, UE-A may send media data to PoC AS (A). UE-A may establish an additional PDP context for media and talk burst control exchange with same IP address and APN as of the PDP contexts of step 3, e.g. a PDP context with traffic class streaming and bandwidth required for the negotiated media parameters. If the UE received an authorization token in step 5, it inserts it in the PDP context signalling. As soon as the PDP context established in step 18 is available, UE-A uses it.
- ~~20-22~~24. UE-A continues sending media. If and when the PDP context established in step ~~19~~22 is available, UE-A uses it. UE-A sends the media data to PoC AS (A), which sends media data to UE-B, via PoC AS (B).
- 25~~3~~. Having received the receiving talk burst message, UE-B may establish an additional PDP context for media and talk burst control exchange with same IP address and APN as of the context(s) of step 3, e.g. a PDP context with traffic class streaming and bandwidth required for the negotiated media parameters. If the UE received an authorization token in step 5, it inserts it in the PDP context signalling.

### 5.3.3.3 Pre-established session with manual answer

A simplified PoC session flow for the setup of session having pre-established session with manual answer is shown below when using GPRS bearer. The flow shows a general case and relation of PDP context with PoC/IMS session and does not show any special order or requirement of whether separate PDP context is required for the media or not. This flow assumes (though it is not required for both sides to use the same mechanism) that both originating and terminating PoC user uses the Pre-established session mechanism.

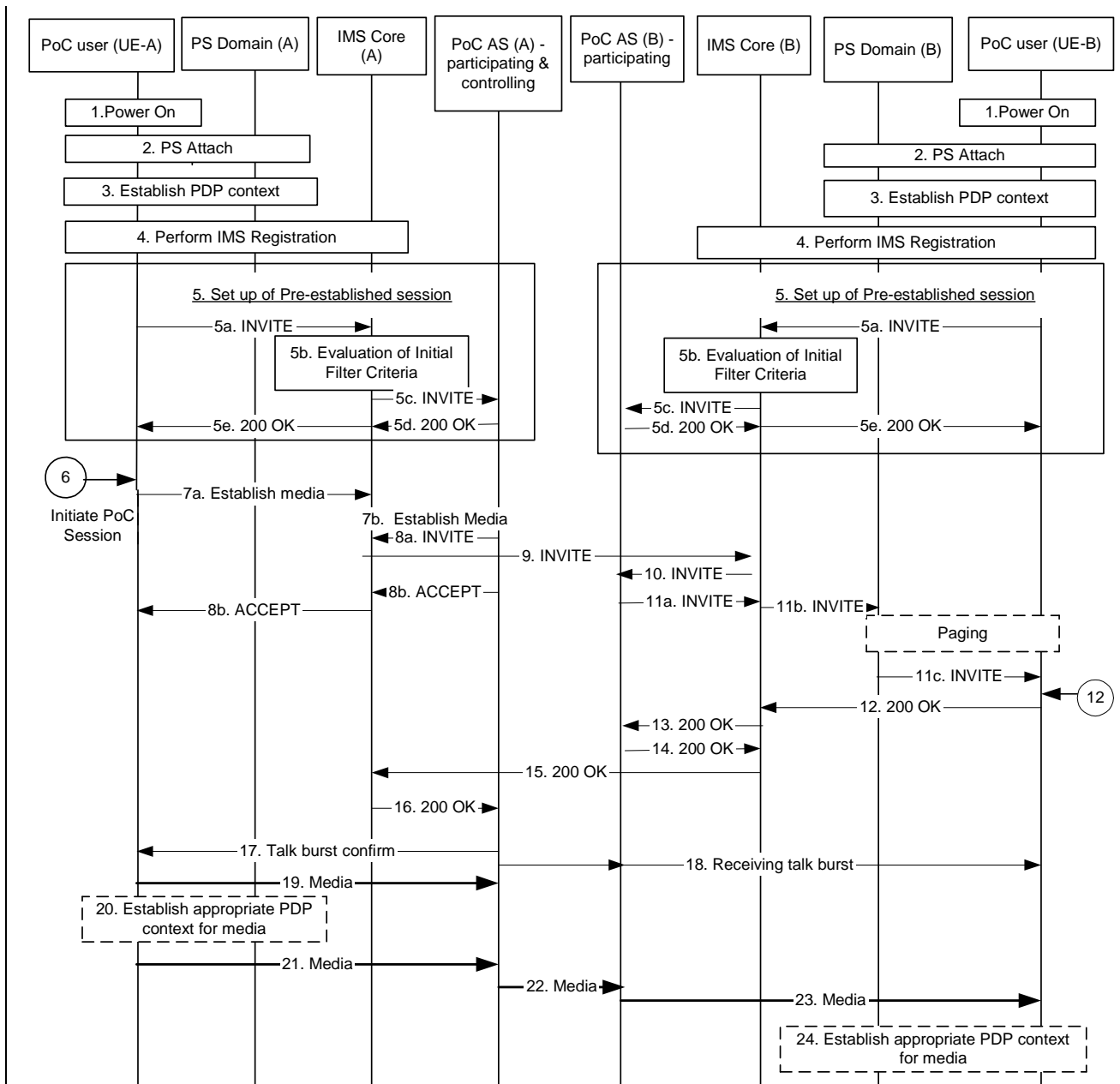

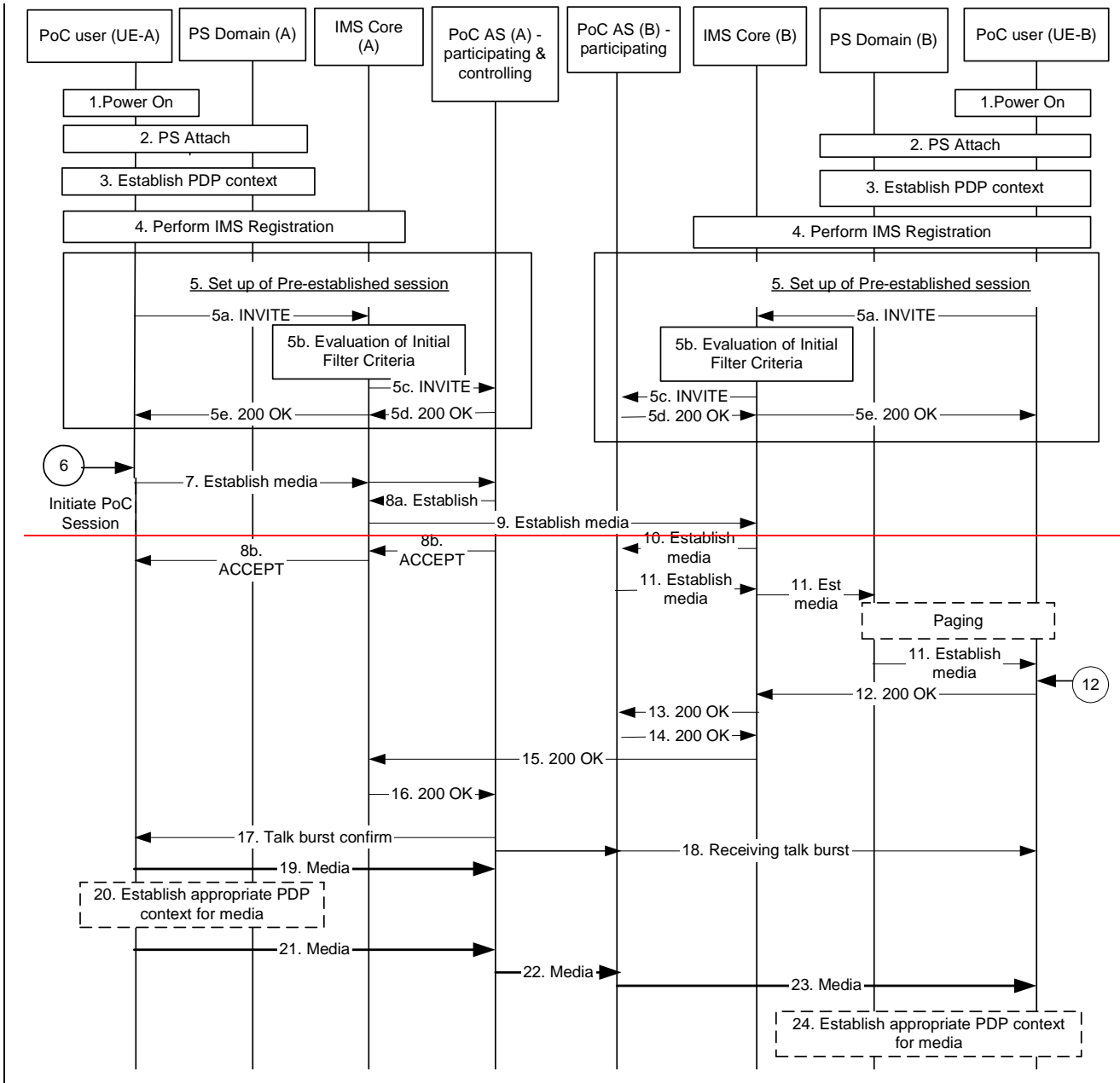

**Figure 5.3.4 Pre-established session handling with manual answer**

The simplified steps for establishing PoC communication based upon pre-established session signalling are:

1. Each terminal is powered on.
2. Each terminal performs PS attach in order to authenticate to the PS domain.
3. Each UE ensures that a PDP context suitable for IMS related signalling is established and if necessary an additional general purpose PDP context with the same APN and IP address as the PDP context for IMS related signalling.  
 Note: This may occur at different times for each terminal. The use of the PDP context bearer(s) depends on how the terminal, network and overall system are configured to operate. Detailed implications of such scenarios will be further analysed in subclause 5.4 and clause 6.

It is FFS whether the QoS of a pre-established PDP context for PoC talk burst control and media is allowed to have a higher QoS than best effort

4. Each terminal performs the IMS registration

5. Each terminal establishes the pre-established session for PoC communication towards the PoC AS (e.g. by using a dedicated PSI). The INVITE request contains the PoC service indication and the SDP media parameters indicate the IP address obtained in step 3; the IMS Core (A) identifies that this service indication matches ISC filtering information and routes the session establishment request to the PoC AS (A).

In case Service Based Local Policy is applied in the UE(A)'s IMS network, IMS Core (A) generates an authorization token for the session, inserts and delivers the authorization token to the UE-A upon set-up of the pre-established session (in the 200OK response).

Note: This pre-established session set-up may occur at different times for each terminal. Once the session relationship is established, it remains as long as the user wishes to remain connected to the PoC server. Implications of such long established session and its relationship with other IMS functions will require further study.

6. User A presses the push-to-talk indication/button on the terminal A to indicate that he wishes to communicate to the user at UE (B).

7a-7b. UE-A requests the establishment of media transfer and sends, for example, a SIP REFER message to the PoC AS (A) via the IMS Core (A), containing the address of the terminating user.

8a-10. PoC AS (A) sends the INVITE message to PoC AS (B) by means of IMS core (A) and IMS Core (B).

8b. PoC AS (A) sends ACCEPT message to UE-A via IMS core (A).

11a-11c. The PoC AS (B) requests the establishment of media transfer and sends, ~~for example,~~ a SIP re-INVITE message to the UE (B) via the IMS Core (B).

Typically UE-B needs to be paged before the SIP re-INVITE message can be transferred.

Note: The re-INVITE message is transparent to the PS Domain

12. After receiving the re-INVITE request, user (B) accepts the session set-up manually and UE-B accepts the session by returning 200 OK. UE-B should send a 180 ringing response when receiving the INVITE request to avoid the re-INVITE request to be re-sent (not shown in the figure). The media parameters indicate the IP address obtained in step 3.
- 13-16. IMS Core (B) forwards the 200 OK to the PoC AS (B), which forwards the 200 OK towards the PoC AS (A) via IMS Core (B) and IMS Core (A).
17. The PoC AS (A) sends a talk burst confirm to UE-A. The talk burst control message is transferred to UE-A on a PDP contexts established in step 3.
18. PoC AS (A) informs the UE-B via the PoC AS (B) that receiving talk bursts from UE-A are on the way.
- 19-20. After the UE-A received both the acknowledgement for the media establishment request message and the talk burst confirm message, UE-A may send media data to PoC AS (A). UE-A may establish an additional PDP context for media and talk burst control exchange with same IP address and APN as of the PDP contexts of step 3, e.g. a PDP context with traffic class streaming and bandwidth required for the negotiated media parameters. If the UE received an authorization token in step 5, it inserts it in the PDP context signalling. As soon as the PDP context established in step 20 is available, UE-A uses it.
- 21-23. UE-A continues sending media. If and when the PDP context established in step 20 is available, UE-A uses it. UE-A sends the media data to PoC AS (A), which sends media data to UE-B, via PoC AS (B).
24. Having received the receiving talk burst message, UE-B may establish an additional PDP context for media and talk burst control exchange with same IP address and APN as of the context(s) of step 3, e.g. a PDP context with traffic class streaming and bandwidth required for the negotiated media parameters. If the UE received an authorization token in step 5, it inserts it in the PDP context signalling.

---

## B.4 On pre-established session

Figure B.3 shows the delay components in case of the session establishment based on ‘pre-established session’ signalling.

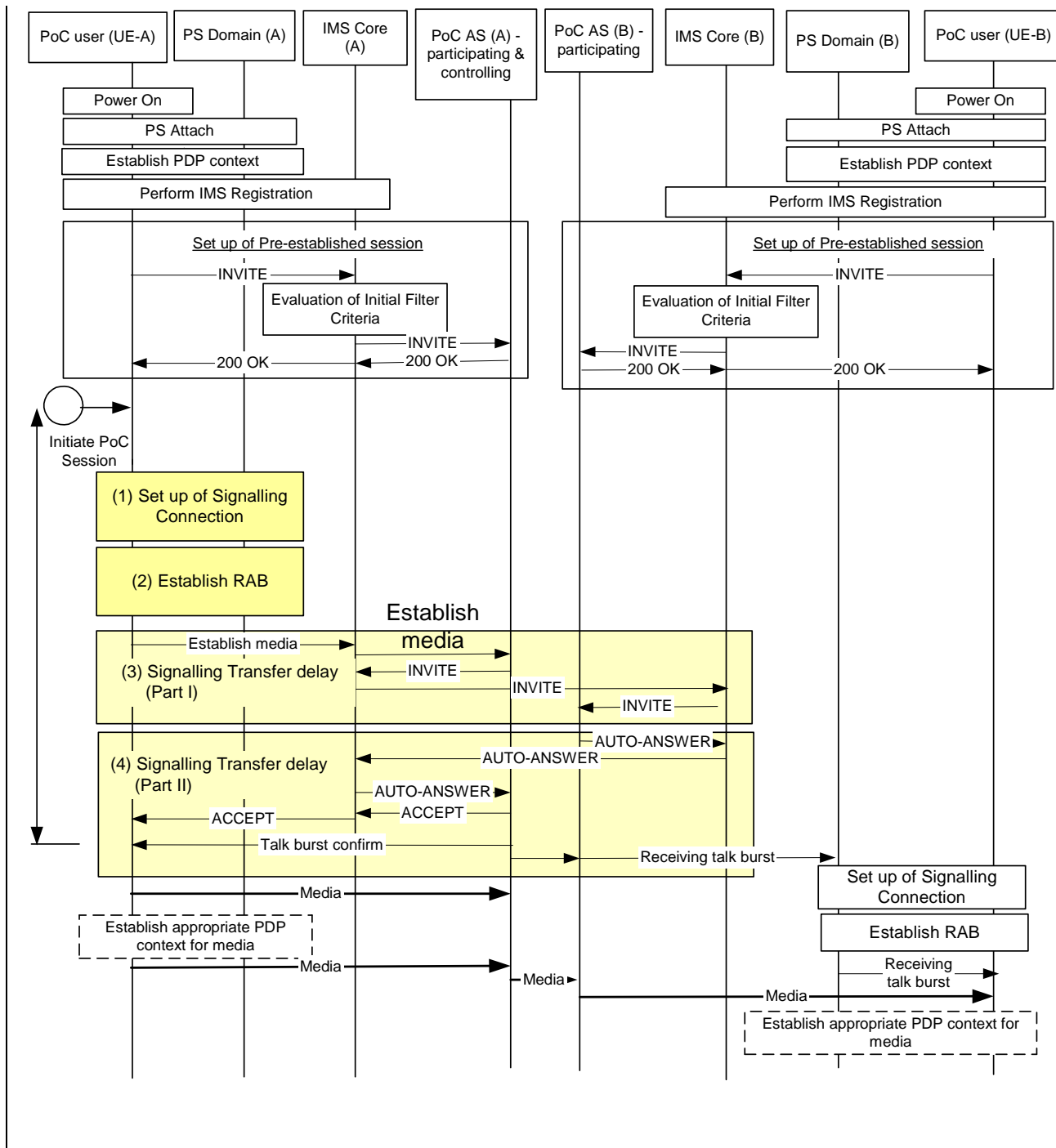

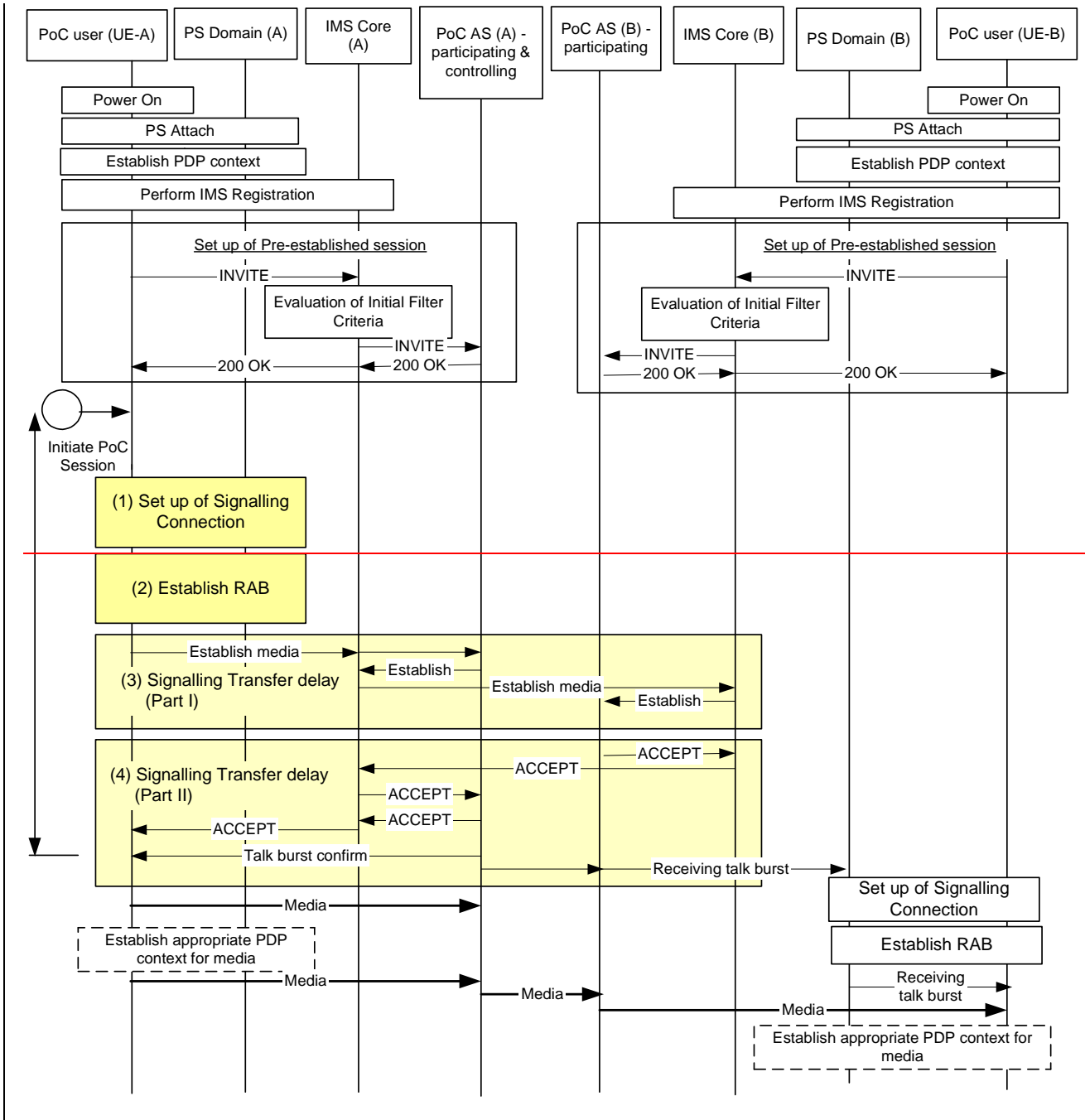

**Figure B.3: Delay component for the case of pre-established session**

(1) Set up of Signalling Connection in the UE-A side

When the User-A initiates a PoC Session, the UE-A shall establish the signalling connection in order to send the NAS signalling. This includes the RRC Connection Setup procedure, the Service Request procedure and the Security Mode Command procedure.

This step is the same as that of the session establishment based on ‘on demand session’.

→ *The estimated delay is about [700ms~1500ms].*

(2) Set up of RAB in the UE-A side

RAB should be established for the existing PDP context through which the SIP REFER message is transmitted by the UE-A.

This step is the same as that of the session establishment based on ‘on demand session’.

→ *The estimated delay is about [700ms~1500ms].*

(3) SIP signalling transfer delay (Part I)

When the user plan is ready to send the REFER message, the UE-A sends the message to the PoC AS (A) and then PoC AS (A) sends the INVITE message to the PoC AS (B).

→ *The estimated delay is less than [500ms]*

(4) SIP signalling transfer delay (Part II)

When it receives the ~~REFER~~-INVITE message, the PoC AS (B) sends the ~~ACCEPT~~-AUTO-ANSWER message to the PoC AS (A) without waiting for the response from the UE-B. It is possible because a 'pre-established session' has been set up beforehand. The PoC AS (A) sends the Talk burst confirm to the UE-A when it receives the ~~ACCEPT~~-AUTO-ANSWER message from the PoC AS (B).

→ *The estimated delay is less than [500ms]*

Therefore, the total estimated delay for the PoC session establishment (the time when the User-A initiates a PoC session ~ the time when the User-A can start to speak) is about [2400ms~4000ms].

Note that the delay of the session establishment using 'pre-established session' is almost the same as that of the session establishment of 'on demand session with automatic answer'.