Source: SA5 (Telecom Management)
Title: Rel-6 TS 32.421 v2.0.0 (Subscriber and equipment trace: Trace concepts and requirements)
Document for: Approval
Agenda Item: 7.5.3

Presentation of Technical Specification to TSG SA

Presentation to: TSG SA Meeting #18
Document for presentation: TS 32.421, Version 2.0.0
Presented for: Approval

Abstract of document:

- This is a Technical Specification on the concepts and requirements of Subscriber and Equipment Trace for Release 6.
- Work done against the WID contained in **SP-020332 Rel-6 BB-level WID (Trace Management)** (Work Item ID: **OAM-Trace**).

Changes since last presentation to TSG-SA Meeting #16:

- Previous Outstanding Issues were resolved.

Outstanding Issues:

- Changes are required to various RAN Technical Specifications. SA5 has defined the detailed requirements pertaining to this issue and communicated them to RAN2 and RAN3. SA5 will continue studying these issues in co-operation with RAN2 and RAN3.
- Changes are required to various CN Technical Specifications. SA5 is working on the detailed requirements and will provide them to the CN groups as soon as possible, presumably after its next meeting in January 2003.
- Changes are required to various GERAN Technical Specifications. SA5 is working on the detailed requirements and will provide them to GERAN as soon as possible.
- In case the concerned 3GPP WGs cannot provide a solution meeting the detailed requirements within Release 6 timeframe, this TS would then be changed accordingly and those requirements would be postponed to a later release. This is also applicable in case the required solution would mean changes to a non-3GPP specification that could not be updated within the Release 6 timeframe.

Contentious Issues:

None

3GPP TS 32.421 V2.0.0 (2002-12)

Technical Specification

**3rd Generation Partnership Project;
Technical Specification Group Services and System Aspects;
Telecommunication Management;
Subscriber and equipment trace:
Trace concepts and requirements
(Release 6)**



The present document has been developed within the 3rd Generation Partnership Project (3GPP™) and may be further elaborated for the purposes of 3GPP.

The present document has not been subject to any approval process by the 3GPP Organizational Partners and shall not be implemented. This Specification is provided for future development work within 3GPP only. The Organizational Partners accept no liability for any use of this Specification. Specifications and reports for implementation of the 3GPP™ system should be obtained via the 3GPP Organizational Partners' Publications Offices.

Keywords

3GPP

Postal address

3GPP support office address

650 Route des Lucioles - Sophia Antipolis
Valbonne - FRANCE
Tel.: +33 4 92 94 42 00 Fax: +33 4 93 65 47 16

Internet

<http://www.3gpp.org>

Copyright Notification

No part may be reproduced except as authorized by written permission.
The copyright and the foregoing restriction extend to reproduction in all media.

© 2002, 3GPP Organizational Partners (ARIB, CWTS, ETSI, T1, TTA, TTC).
All rights reserved.

Contents

Foreword.....	4
Introduction.....	4
1 Scope	6
2 References	6
3 Definitions, symbols and abbreviations.....	7
3.1 Definitions.....	7
3.2 Abbreviations	8
4 Trace Concepts	8
5 Trace Requirements	10
5.1 General Trace Requirements	10
5.2 Requirements for Trace Data	10
5.3 Requirements for Trace Activation	11
5.3.1 Requirements for Trace Session Activation	11
5.3.2 Requirements for Starting a Trace Recording Session	11
5.4 Requirements for Trace Deactivation.....	12
5.4.1 Requirements for Trace Session Deactivation.....	12
5.4.2 Requirements for Stopping a Trace Recording Session.....	12
5.5 Requirements for Trace Data Reporting.....	13
5.6 Use Cases for Trace.....	13
Annex A (informative): Trace Functional Architecture: High-level View	14
A.1 Figure of Trace functional architecture	14
Annex B (informative): Trace Use Cases.....	15
B.1 Use Case #1: Multi-vendor MS validation	15
B.1.1 Description	15
B.1.2 Example of Required Data for this Use Case	15
B.2 Use Case #2: Subscriber Complaint	15
B.2.1 Description	15
B.2.2 Example of Required Data for this Use Case	16
B.3 Use Case #3: Malfunctioning MS.....	17
B.3.1 Description	17
B.3.2 Example of Required Data for this Use Case	17
B.4 Use case #4: Checking radio coverage	17
B.4.1 Description	17
B.4.2 Example of Required Data to cover use case #4.....	17
B.5 Use case #5: Testing a new feature.....	18
B.5.1 Description	18
B.5.2 Example of Required Data to cover use case #5.....	18
B.6 Use case #6: Fine-tuning and optimisation of algorithms/procedures.....	18
B.6.1 Description	18
B.6.2 Example of Required Data to cover use case #6.....	19
Annex C (informative): Change history.....	20

Foreword

This Technical Specification has been produced by the 3rd Generation Partnership Project (3GPP).

The present document is part of the 32.420-series covering the 3rd Generation Partnership Project; Technical Specification Group Services and System Aspects; Telecommunication Management; Subscriber and equipment trace feature, as identified below:

TS 32.421: "Trace concepts and requirements";

TS 32.422: "Trace control and configuration management";

TS 32.423: "Trace data definition and management";

Additionally, there is a GSM only Subscriber and equipment trace specification: 3GPP TS 52.008.

The contents of the present document are subject to continuing work within the TSG and may change following formal TSG approval. Should the TSG modify the contents of the present document, it will be re-released by the TSG with an identifying change of release date and an increase in version number as follows:

Version x.y.z

where:

- x the first digit:
 - 1 presented to TSG for information;
 - 2 presented to TSG for approval;
 - 3 or greater indicates TSG approved document under change control.
- y the second digit is incremented for all changes of substance, i.e. technical enhancements, corrections, updates, etc.
- z the third digit is incremented when editorial only changes have been incorporated in the document.

Introduction

Subscriber and MS Trace provide very detailed information at call level on one or more specific mobile(s). This data is an additional source of information to Performance Measurements and allows going further in monitoring and optimisation operations.

Contrary to Performance Measurements, which are a permanent source of information, Trace is activated on user demand for a limited period of time for specific analysis purposes.

Trace plays a major role in activities such as determination of the root cause of a malfunctioning mobile, advanced troubleshooting, optimisation of resource usage and quality, RF coverage control and capacity improvement, dropped call analysis, Core Network and UTRAN end-to-end UMTS procedure validation.

The capability to log data on any interface at call level for a specific user (e.g. IMSI) or mobile type (e.g. IMEI or IMEISV) allows getting information which cannot be deduced from Performance Measurements such as perception of end-user QoS during his call (e.g. requested QoS vs. provided QoS), correlation between protocol messages and RF measurements, or interoperability with specific mobile vendors.

Moreover, Performance Measurements provide values aggregated on an observation period, Subscriber and Equipment Trace give instantaneous values for a specific event (e.g. call, location update, etc.).

If Performance Measurements are mandatory for daily operations, future network planning and primary trouble shooting, Subscriber and MS Trace is the easy way to go deeper into investigation and UMTS network optimisation.

In order to produce this data, Subscriber and MS Trace are carried out in the NEs, which comprise the network. The data can then be transferred to an external system (e.g. an Operations System (OS) in TMN terminology, for further evaluation).

1 Scope

The present document describes the requirements for the management of Trace and the reporting of Trace data across UMTS networks as it refers to subscriber tracing (tracing of IMSI or Public ID) and MS tracing (tracing of IMEI or IMEISV). It defines the administration of Trace Session activation/deactivation by the Element Manager (EM) or the network itself via signalling, the generation of Trace results in the Network Elements (NEs) and the transfer of these results to one or more Operations Systems, i.e. EM(s) and/or Network Manager(s) (NM(s)).

The basic Subscriber and MS Trace concept that the present document is built upon is described in clause 4. The high level requirements for Trace data, Trace Session activation/deactivation and Trace reporting are defined in clause 5. Clause 5 also contains an overview of use cases for Trace (the use cases are described in Annex B). Annex A provides a high-level view of Trace functional architecture. Trace control and configuration management are described in 3GPP TS 32.422 [2], and Trace data definition and management are described in 3GPP TS 32.423 [3].

In this release, the present document does not cover any Trace capability limitations within a NE (e.g. maximum number of simultaneous traced mobiles for a given NE) or any functionality related to these limitations (e.g. NE aborting a Trace Session due to resource limitations).

The objectives of UMTS Trace specifications are:

- to provide the descriptions for a standard set of Trace data;
- to produce a common description of the management technique for Trace administration and result reporting; and
- to define a method for Trace results reporting across the management interfaces.

The following is beyond the scope of the present document, and therefore the present document does not describe:

- tracing non-Subscriber or non-MS related events within a network element;
- tracing of all possible parties in a multi-party call (although multiple calls related to the IMSI specified in the Trace control and configuration parameters are Traceable);
- tracing of all active sessions in a cell or a given area (based on the identification of the area itself);
- tracing within an MS (the scope of Trace is only within the network).

The definition of Trace data is intended to result in comparability of Trace data produced in a multi-vendor wireless UMTS network, for those Trace control and configuration parameters that can be standardised across all vendors' implementations.

Vendor specific extensions to the Trace control and configuration parameters and Trace data are discussed in 3GPP TS 32.422 [2] and 3GPP TS 32.423 [3].

2 References

The following documents contain provisions, which, through reference in this text, constitute provisions of the present document.

- References are either specific (identified by date of publication, edition number, version number, etc.) or non-specific.
- For a specific reference, subsequent revisions do not apply.
- For a non-specific reference, the latest version applies. In the case of a reference to a 3GPP document (including a GSM document), a non-specific reference implicitly refers to the latest version of that document *in the same Release as the present document*.

[1] 3GPP TS 32.101: "Telecommunication management; Principles and high level requirements".

- [2] 3GPP TS 32.422: "Telecommunication management; Subscriber and equipment trace: Trace control and configuration management".
- [3] 3GPP TS 32.423: "Telecommunication management; Subscriber and equipment trace: Trace data definition and management".
- [4] 3GPP TS 23.002: "Network architecture".
- [6] 3GPP TS 29.207: "Policy control over Gs interface".
- [7] 3GPP TS 52.008: "Telecommunication management; GSM subscriber and equipment trace".
- [8] 3GPP TR 21.905: "Vocabulary for 3GPP Specifications".
- NOTE: Overall management principals are defined in 3GPP TS 32.101 [1].

3 Definitions, symbols and abbreviations

3.1 Definitions

For the purposes of the present document, the following terms and definitions apply:

Mobile Station (MS): term indicating Mobile Station and comparable to the terms Equipment and User Equipment

management activation/deactivation: Trace Session is activated/deactivated in different NEs directly from the EM using the management interfaces of those NEs

signalling based activation/deactivation: Trace Session is activated/deactivated in different NEs using the signalling interfaces between those elements so that the NEs may forward the activation/deactivation originating from the EM

Trace: general term used for Subscriber and Equipment Trace

Trace record: in the NE a Trace record is a set of Traceable data collected as determined by the Trace control and configuration parameters

Trace Recording Session: time interval within a Trace Session while trace records are generated for the subscriber or MS being traced.

The triggering events starting and stopping a Trace Recording Session are defined in 3GPP TS 32.422 [2] (figure 1).

Trace Recording Session Reference: identifies a Trace Recording Session within a Trace Session (see figure 1)

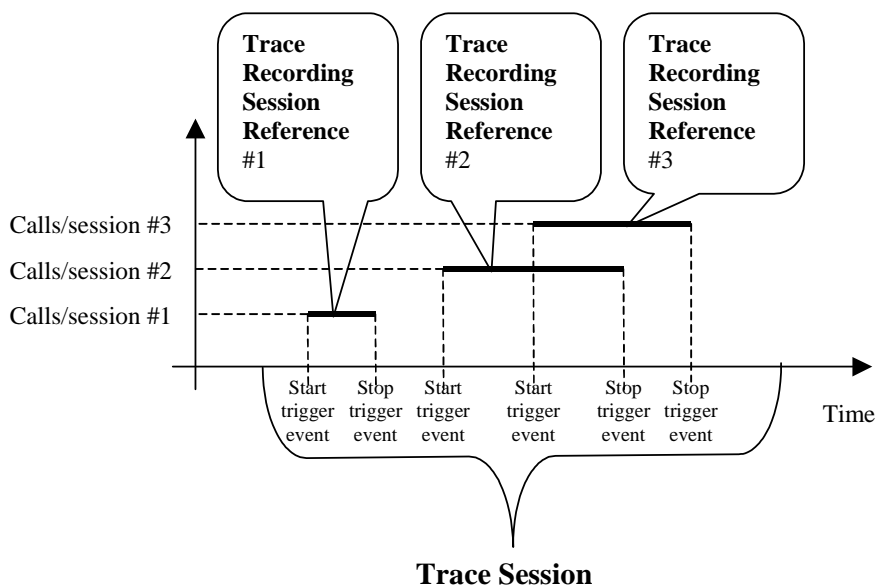

Figure 1: Trace Recording Session

Trace Reference: identifies a Trace Session and is globally unique (see figure 2)

Trace Session: time interval started with a Trace Session Activation and lasts until the Deactivation of that specific Trace Session (see figure 2)

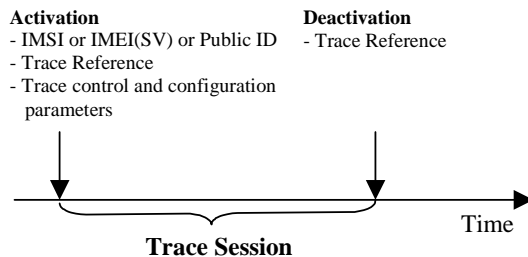

Figure 2: Trace Session

3.2 Abbreviations

For the purposes of the present document, the abbreviations given in 3GPP TR 21.905 [8] and 3GPP TS 32.101 [1] apply.

4 Trace Concepts

The diversity of Trace requirements makes it difficult to identify and anticipate all the operator's specific needs. Thus, the objective of this TS is not to list an exhaustive set of information to meet all the requirements. Rather, Trace data is defined without any limitation on the 2 following dimensions:

- Trace scope: NEs and signalling interfaces to Trace.
- Trace depth: level of details of Trace data.

In order to not have any limitation of Trace data, there are three levels of details defined: Maximum, Minimum and Medium. The Maximum Level allows all Trace data to be recorded. The Minimum and Medium Levels provide a decoded subset of the data in the Maximum Level and allow an operator the flexibility in selecting the appropriate Trace data to record.

The Trace Depth, specified at the Trace Session activation, is used to choose the level of detail of information to retrieve on the Itf-N.

The Maximum Level of detail allows for retrieval of signalling interface messages within the Trace Scope in encoded format (see figure 3).

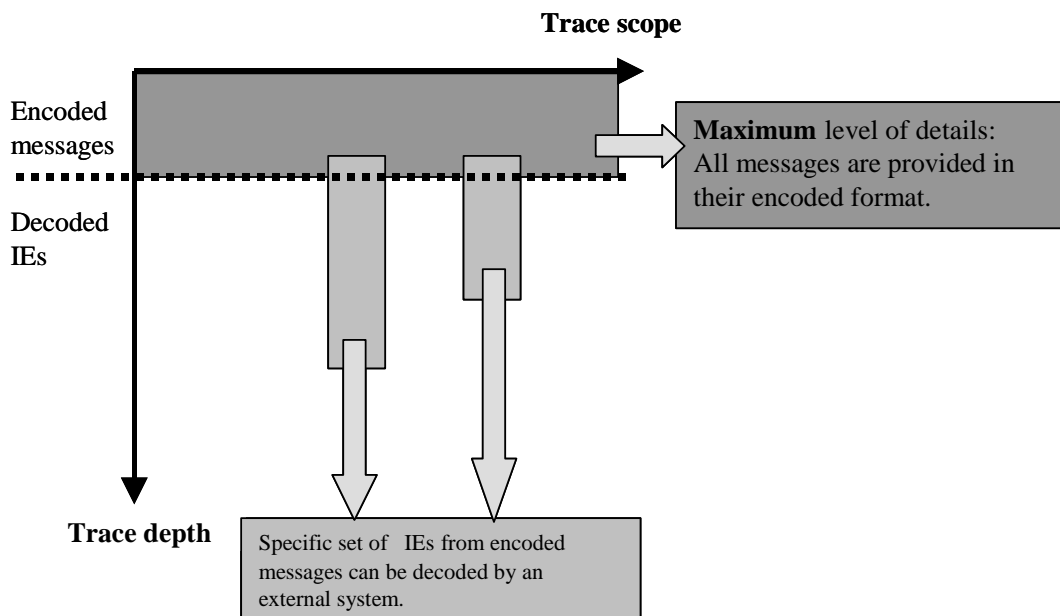

Figure 3: Maximum Level of details of Trace

The Minimum Level of detail allows for retrieval of a decoded subset of the IEs contained in the signalling interface messages (see figure 4).

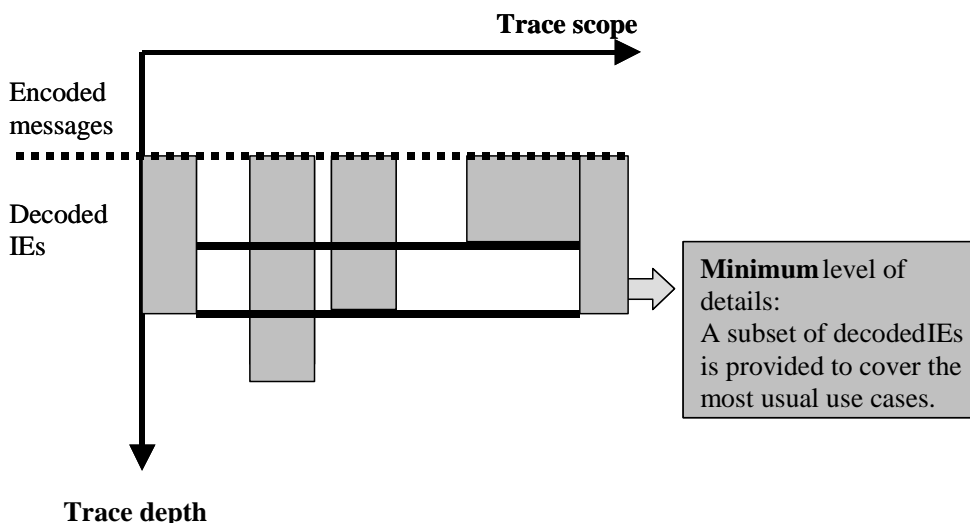

Figure 4: Minimum Level of detail of Trace

The Medium Level of detail allows for retrieval of the decoded subset of the IEs contained in the signalling interface messages in the Minimum Level plus a selected set of decoded radio measurement IEs.

The Trace data recorded at each Level is defined in 3GPP TS 32.423 [3].

5 Trace Requirements

5.1 General Trace Requirements

The general high-level requirements for Trace, common to both Management activation/deactivation and Signalling based activation/deactivation, are as follows:

- for the Maximum Level: Trace data encompassing all signalling messages on the different interfaces dedicated to the events of the traced subscriber or MS with their entire content (all IEs) shall be retrieved. The operator can then use an external system (e.g. an Operations System (OS) in TMN terminology) and decode specific information in line with operator requirements.
- for the Minimum Level: a selected subset of IEs shall be retrieved from the signalling interface messages. The Minimum Level provides support for the most common use cases (described in the annex B).
- for the Medium Level: a selected Minimum Level subset of IEs from the signalling interface messages and a selected set of radio measurement IEs shall be retrieved.

5.2 Requirements for Trace Data

The high level requirements for Trace Data, common to both Management activation/deactivation and Signalling based activation/deactivation, are as follows:

- The Trace records have to contain Information Elements or signalling messages from control signalling and/or the characteristics of the user data. The following list contains the Network Elements and the Traceable interfaces in the NEs where tracing is needed:
 - MSC Server: A, Iu-CS, Mc and MAP (G, B, E, F) interfaces;
 - MGW: ATM, IP and TDM interfaces for user plane characteristics;
 - HSS: MAP (C, D, Gc, Gr) and Cx interfaces and location and subscription information;
 - SGSN: Gb, Iu-PS, Gn, MAP (Gr, Gd, Gf), CAP (Ge) and Gs interfaces;
 - GGSN: Gn and Gi interfaces;
 - S-CSCF: Mw, Mg, Mr and Mi interfaces;
 - P-CSCF: Gm and Go interfaces;
 - RNC: Iu-CS, Iu-PS, Iur, Iub and Uu interfaces;
 - BSC: Um, Abis, A and Gb interfaces.
- A unique ID within a Trace Session shall be generated for each Trace Recording Session. This is called the Trace Reference.

Changes to existing NEs and interfaces above may be required. These changes would be dependent upon various 3GPP working groups and possibly other non-3GPP industry groups for completion of Trace Session activation/deactivation.

For a detailed description of network elements and interfaces above see 3GPP TS 23.002 [4].

5.3 Requirements for Trace Activation

5.3.1 Requirements for Trace Session Activation

The high level requirements for Trace Session activation, common to both Management activation and Signalling based activation), are as follows:

- In case of subscriber Trace, the Trace Session will be activated for a certain subscriber whose identification (IMSI in UTRAN/GERAN/CS/PS or Public ID in IMS) shall be known in the NEs where subscriber Trace is needed.
- In case of MS Trace, the Trace Session will be activated for a certain MS whose identification (IMEI or IMEISV) shall be known in the NEs where MS Trace is needed.
- Trace Session activation shall be possible for both home subscribers and visiting subscribers.
- There are two methods for Trace Session activation: Management activation and Signalling activation.
- For an established call/session within a Network Element, it is optional for the Network Element to start a Trace Recording Session for the associated Subscriber or MS upon receipt of the Trace activation request from the EM.
- A globally unique ID shall be generated for each Trace Session to identify the Trace Session. This is called the Trace Reference.
- Trace Session may be activated from the EM simultaneously to multiple NEs with the same Trace Reference (i.e. same Trace Session).
- The Trace Scope and Depth shall be specified within the control and configuration parameters during Trace Session activation.
- There can be cases in a NE when it receives multiple Trace Session activations for the same connection (e.g. simultaneous CS/PS connections). In these cases the starting time of the Trace Session Activation and the starting time of the first Trace Recording Session is the same using signalling based activation. For these cases there are two different cases for the Trace Session activation in a Network Element when it receives another Trace Session activation to the same subscriber or MS:
 - If the Trace Reference is equal to an existing one, a new Trace Session shall not be started;
 - If the Trace Reference is not equal to an existing one, a new Trace Session may be started.
- The EM shall always provide the trace control and configuration parameters to the appropriate NEs at the time of Trace Session activation.

5.3.2 Requirements for Starting a Trace Recording Session

The high level requirements for starting a Trace Recording Session, common to both Management activation and Signalling based activation), are as follows:

- It is optional for the NE to start a Trace Recording Session if there are insufficient resources available within the NE.
- The Trace Recording Session Reference shall be unique within a Trace Session.
- The Trace Recording Session should be started after appropriate start trigger events are detected.

The high level requirements for starting a Trace Recording Session, specific to Management activation, are as follows:

- Each NE shall generate its own Trace Recording Session Reference (i.e., independent Trace Recording Sessions).
- Each NE shall start the Trace Recording Session based upon the Trace control and configuration parameters received by the NE in the Trace Session activation.
- The correlation of Trace data will be done with a Trace Reference and IMSI / IMEI / IMEISV / public ID.

- The Trace Recording Session can start only when the IMSI (in case of subscriber trace), the IMEI / IMEISV (in case of MS trace) or public ID (in case of IMS) is made available in the NE. In order to trace the early phases of the call the IMSI (in case of subscriber trace), the IMEI / IMEISV (in case of MS trace) or public ID (in case of IMS) shall be made available to the NE as soon as practically possible.

E.g. the IMSI and IMEI / IMEISV shall be made available to both Serving RNC and Drift RNC.

5.4 Requirements for Trace Deactivation

5.4.1 Requirements for Trace Session Deactivation

The high level requirements for Trace Session deactivation, common to both Management deactivation and Signalling based deactivation, are as follows:

- The Trace Session shall be deactivated using the Trace Reference specified for the Trace Session activation.
- The Trace Session shall be deactivated in all those NEs where it was activated.
- The deactivation of a Trace Session during a Trace Recording Session within a Network Element may take place anytime after the Network Element receives the deactivation request until the end of the current Trace Recording Session related to the traced Subscriber or MS.
- Trace Session deactivation in a NE could occur when two simultaneous signalling connections for a subscriber or MS exist. E.g. figure 5 shows NE 3 having two signalling connections (one of them or both of them are traced with the same Trace Reference) and a Trace deactivation message is received. The Trace Session shall be closed.

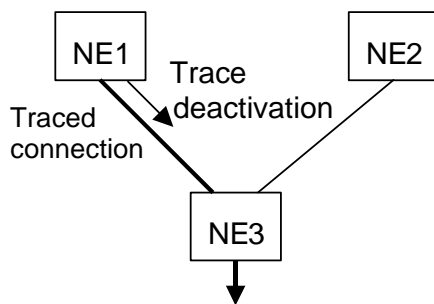

Figure 5: Trace Session closure

5.4.2 Requirements for Stopping a Trace Recording Session

The high level requirements for stopping a Trace Recording Session, common to both Management deactivation and Signalling based deactivation, are as follows:

- The Trace Recording Session should be stopped after appropriate stop trigger events are detected.
- Trace Session deactivation in a NE could occur when two simultaneous signalling connections for a subscriber or MS exist. E.g. figure 6 shows NE3 having two signalling connections, but only one connection is traced. If the non-traced connection is released, the Trace Recording Session shall be kept in NE3. If the traced connection is released the Trace Recording Session shall be closed.

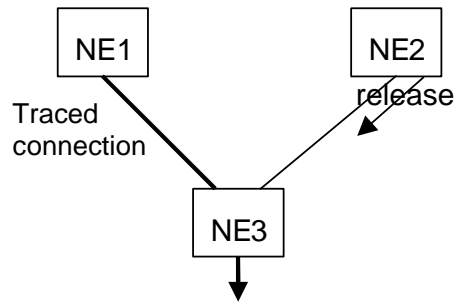

Figure 6: Trace Recording Session closure

The high level requirements for stopping a Trace Recording Session, specific to Signalling based deactivation, are as follows:

- The Trace Recording Session should be stopped after an NE receives the appropriate signalling deactivation message.

5.5 Requirements for Trace Data Reporting

The high level requirements for Trace Data reporting, common to both Management activation/deactivation and Signalling based activation/deactivation, are as follows (Trace record contents, file formats and file transfer mechanisms are defined in 3GPP TS 32.423 [3]):

- Trace records should be generated in each NE where a Trace Session has been activated and a Trace Recording Session has been started.
- Format of the Trace records shall be XML Schema or ASN.1.
- Trace records should be transferred on the Itf-N to the Network Manager using one of two approaches: direct transfer from NE to NM or transfer from NE to NM via EM.

For transfer of Trace records via Itf-N, FTP shall be used.

5.6 Use Cases for Trace

The operator can use subscriber and MS Trace for numerous purposes. However, the use cases for Trace can be divided into two basic categories:

- Troubleshooting use cases cover situations where the operator is solving an existing problem in his network;
- Validation testing use cases cover situations where the operator is not solving a known problem but merely analysing, fine-tuning or optimising his network.

A more detailed description for the following use cases for subscriber and MS Trace can be found in annex B:

- Interoperability checking between MS from different vendors;
- QoS profile checking for a subscriber after a subscriber complaint;
- Malfunctioning MS;
- Checking radio coverage in a certain area;
- Testing new features;
- Fine-tuning and optimisation of algorithms or procedures.

Annex A (informative): Trace Functional Architecture: High-level View

A.1 Figure of Trace functional architecture

Figure A.1 represents the high-level view of the functional architecture of Trace. Note that Trace record reporting can be done directly from NE to NM or from NE to NM via EM, but not both simultaneously.

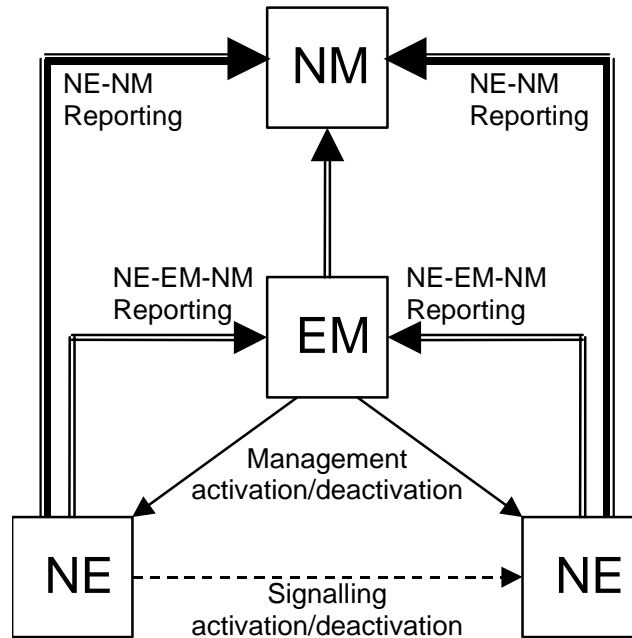

Figure A.1: High-level view of Trace

Annex B (informative): Trace Use Cases

B.1 Use Case #1: Multi-vendor MS validation

B.1.1 Description

The aim of this use case is to check how different vendor's MSs are working (e.g. in field testing) in the mobile network or to get detailed information on the MS.

The study can be started by an initiative from operator for verification of MS from different vendors (e.g. testing how the MS fulfils the requirements set by the standards).

The operator can perform the test using test MSs or tracing subscribers' mobiles.

B.1.2 Example of Required Data for this Use Case

The Trace parameters required to cover use case #1 are listed below:

- Tracing is needed in the Radio Network (BSC/RNC) or in the Core Network (MSS, SGSN);
- The identification of the Trace case shall be IMEI or IMEISV (and possibly IMSI);
- The level of details usually is to get the most important IEs from the signalling messages (Medium Level) or all messages with their encoded IEs (Maximum Level).

The traceable protocols are:

- In BSC: RR.
- In RNC: RRC, NBAP, RNSAP, RANAP.
- In MSS/SGSN: DTAP messages.

B.2 Use Case #2: Subscriber Complaint

B.2.1 Description

The aim of this use case is to check how the complaining subscriber's services are working, to get information on the services in order to find out the reason for the complaint.

The study can be started after a subscriber is complaining at his/her home or visited operator that some of the service to which he/she subscribed is not working. E.g. the subscriber:

- cannot make calls;
- cannot use some supplementary service;
- does not get the negotiated QoS level (e.g. Mobile subscriber activates video-streaming application to watch the latest sport events and every time the subscriber tries to connect to the service the system disconnects the subscriber's UMTS bearer).

As the Trace is activated for a subscriber, the signalling based Trace Session activation shall be used, as the location of the subscriber is not known.

B.2.2 Example of Required Data for this Use Case

The Trace parameters required to cover the use case #2 are listed below:

- The list of NEs where tracing may be needed depends on the service being complained about by the subscriber. For this use case, tracing should be possible in all network elements, such as: HSS, MSS, BSC, RNC, MGW, SGSN, GGSN, S-CSCF, P-CSCF.
- The identification of the subscriber in a Trace is IMSI in UTRAN/GERAN/CS/PS or public ID in IMS. The identification of the MS in a Trace is IMEI or IMEISV.
- The data includes those Information Elements from the signalling messages, which are related to the service(s) being complained about by the subscriber (Medium Level).

Example cases, which can be the basis for subscriber complaint:

1. The subscriber cannot make an IM session.

Tracing is needed in HSS, S-CSCF, P-CSCF, SGSN, GGSN and UTRAN. The subscriber identification for this case is public ID in IMS and IMSI in PS domain. From the HSS Trace the operator can determine whether the service in question or IM session establishment is allowed for the subscriber. From the S-CSCF and P-CSCF Trace the operator can examine the SIP signalling together with the SDP, which contains information on the media, while in the P-CSCF Trace the QoS negotiation with GGSN can be determined so in P-CSCF the COPS messages should be traced. From COPS (see 3GPP TS 29.207 [6] for more information on COPS) those parameters are needed, which show how the QoS Policy control is working, whether the session was dropped due to the QoS negotiation. If the source of the complaint is not found in IMS, tracing in SGSN, GGSN and in UTRAN is needed. From SGSN Trace record the QoS parameters, PDP contexts related information can be known while from UTRAN Trace information on the radio coverage and also some QoS related information can be known.

2. The subscriber's CS call is misrouted

This illustrates an instance where a subscriber complains that his calls are being cross-connected (or misrouted). Such a complaint involves setting up a Trace at all the 3GPP standardised interfaces being handled by the MSC. However, the Trace functionality shall not cover MSC internal or vendor proprietary interfaces. The Trace record shall need to have the dialled number and connected number.

3. The subscriber's call is dropped

Tracing data is required from the radio network (UTRAN/GERAN) or from the core network (MSS, SGSN, GGSN). In the radio network the radio coverage shall be checked. See use case #4 (checking radio coverage). Beside the radio coverage, other information can be useful as well, like RLC parameter, power information (OLPC or RRC measurement report), error ratios (BLER / BER, SDU error ratio), etc. Tracing in the core network is needed also, if the problem is not in the radio network. E.g. in case of PS domain the call can be dropped by the application due to the long delays or congestions in TCP layer or due to bad QoS. Thus in SGSN the requested and negotiated QoS parameters should be included in the Trace record.

4. The received QoS level is less than the negotiated level.

To be able to solve the possible problem Tracing data is required from HSS, SGSN, GGSN, UTRAN, and GERAN. Furthermore in case of problem in CS calls tracing in MGW shall be performed.

From HSS Trace data the operator can monitor whether the subscriber's authentication to the network is successful, and what kind of QoS parameters are allowed to the subscriber. From SGSN Trace data the operator can monitor PDP context creation request from mobile. Request seem to contain legal QoS profile (incl. Maximum bandwidth, guaranteed bandwidth etc) and the local resources in SGSN are available to provide the service as requested by the subscriber. From UTRAN/GERAN Trace data the operator can monitor whether the maximum bandwidth and guaranteed bandwidth, requested by SGSN, acceptable for UTRAN/GERAN. Thus to check whether UTRAN/GERAN can provide and maintain the requested radio access bearer services. From GGSN Trace data the operator can monitor PDP context activation between SGSN and GGSN. If the problem is in the CS domain the MGW Trace can provide the QoS data.

B.3 Use Case #3: Malfunctioning MS

B.3.1 Description

The aim of this use case is to check a MS, which is not working correctly.

The study can be initiated by the operator when he/she suspects that a MS not working according to the specifications or he/she would like to get more information on a specific MS, which is on the grey or black EIR list.

B.3.2 Example of Required Data for this Use Case

The Trace parameters required to cover the use case #3 are listed below:

- MS Tracing may be needed in the Radio Network (UTRAN/GERAN) or in the Core Network (MSS, SGSN).
- The identification of the subscriber in a Trace is IMSI. The identification of the MS in a Trace is IMEI or IMEISV.
- The level of details depends on the operator needs (either Minimum Level or Medium Level).

The malfunction of MS in UTRAN/GERAN can occur in different places. The problem can be in basic RRC and RANAP signalling, Radio Bearer procedures, Handover procedures, Power control etc.

Therefore, all RRC, RANAP, NBAP, RNSAP signalling procedures, transmission powers, error ratios (BLER / BER, SDU error ratio) and retransmission can be included in the Trace records.

B.4 Use case #4: Checking radio coverage

B.4.1 Description

This use case aims at checking the radio coverage on a particular network area.

This study can be started by an initiative from operator for testing radio coverage on a particular geographical area following network extension for instance (e.g. new site installation).

The operator can perform a drive test on the new site area, and check that radio coverage is correct.

B.4.2 Example of Required Data to cover use case #4

The DL radio coverage can be checked using the values of CPICH Ec/No and RSCP measured by the mobile on the cells in the active set and the monitored set. These measurements are sent to the RNC through the RRC message MEASUREMENT REPORT.

The UTRAN Trace record intra frequency measurement contains the required information.

The UTRAN Trace record inter frequency, and inter RAT measurements can also be used to check radio coverage with other frequencies or systems.

After a network extension, the operator can check that Ec/No and RSCP levels on the new site area are the expected ones, and there is no coverage hole.

The following Trace parameters are required to cover use case #4:

- The type of NE to Trace is RNC.
- The identification of the subscriber in a Trace is IMSI. The identification of the MS in a Trace is IMEI or IMEISV.

- The Trace data to retrieve shall contain the messages with all IEs that are relevant for radio coverage.

B.5 Use case #5: Testing a new feature

B.5.1 Description

This use case aims at testing the implementation of a new feature in the network before its general deployment. The functionality can be either a standard feature or a vendor/operator specific feature.

This study is started by an initiative from the operator.

The operator can perform a drive test on the area where the feature is introduced, and check its good behaviour as well as its benefits, in term of quality or capacity. He can also rely on subscribers' Trace data when they use the feature to be tested.

B.5.2 Example of Required Data to cover use case #5

Depending on the feature, the list of NEs to Trace, as well as the level of details can be different.

For a feature concerning Core, UTRAN and GERAN networks, for instance hard handover, SRNS relocation, or new UMTS bearer service, the operator needs to activate Trace on several NEs.

Then, the operator can be interested in:

- Only the protocol messages generated by the feature; or
- The impact of the new feature introduction on the network, for instance, the radio coverage, the capacity, the quality, or the behaviour of the existing algorithms.

In this last case, the operator needs more detailed data, for instance messages with all (Maximum Level) or part of the IEs (Minimum Level).

The following Trace parameters are required to cover use case #5:

- The types of NEs to Trace are NEs that can be traced related to the feature.
- The identification of the subscriber in a Trace is IMSI. The identification of the MS in a Trace is IMEI or IMEISV.
- The Trace data to retrieve can be either only the protocol messages (Maximum Level) or the messages with all or part of the IEs (Minimum Level).

B.6 Use case #6: Fine-tuning and optimisation of algorithms/procedures

B.6.1 Description

Subscriber and MS Trace is part of the optimisation process. Trace data are used to get feedback on the network quality and capacity after optimisation operations like parameter fine-tuning, or new network design. Each intervention to improve the network behaviour can be confirmed both by measurement data and Trace data.

This study is started following an initiative from the operator.

The operator can perform a drive test on the area where the optimisation has been performed, and check its good behaviour as well as its impact on the network. He can also rely on subscribers' Trace data when they use the feature to be optimised.

B.6.2 Example of Required Data to cover use case #6

Depending on the optimisation operation, the list of NEs to Trace, as well as the level of details can be different. But generally, fine-tuning activities like scrambling code plan, handover and relocation algorithms, or call admission algorithm optimisation concern a very specific part of the network.

To cover this use case, the operator is usually searching for the highest level of details, on specific NEs.

The following Trace parameters are required to cover use case #6:

- The types of NEs to Trace are any NE that can be traced related to the feature to optimise.
- The identification of the subscriber in a Trace is IMSI. The identification of the MS in a Trace is IMEI or IMEISV.
- The Trace data to retrieve are the messages in encoded format with all (Maximum Level) or part of the IEs (Minimum Level).

Annex C (informative): Change history

Change history							
Date	TSG #	TSG Doc.	CR	Rev	Subject/Comment	Old	New
Jun 2002	S_16	SP-020330	--	--	Submitted to SA #16 for Information	1.0.0	
Dec 2002	S_18	SP-020755	--	--	Submitted to SA #18 for Approval	2.0.0	