

TSG-SA meeting #3
26 - 28 April 1999
Yokohama

TSGSP#3(99)149

Title: UMTS 23.020 version 1.6.1
Source: TSG SA WG2
Purpose: Approval

Extract from meeting report SMG#28 meeting, February 1999:

“UMTS 30.01, *UMTS Baseline document*, in Tdoc SMG P-99-112 was presented by Antun Samukic to SMG#28. The document shall be updated according to major decisions at SMG#28. The updated document shall be distributed to SMG for approval by 22 February 1999. The UMTS 30.01 shall be transferred to 3GPP. Further use of the UMTS Baseline document for SMG can be studied later.”

This version of the UMTS Baseline document reflects the last approved version of the document by SMG and is transferred and given to 3GPPP for further work.

**Evolution of the GSM platform towards UMTS
UMTS 23.20 version 1.6.1**



European Telecommunications Standards Institute

Reference

DTR/SMG-032320U

Keywords

UMTS, GSM Evolution

ETSI Secretariat

Postal address

F-06921 Sophia Antipolis Cedex - FRANCE

Office address

650 Route des Lucioles - Sophia Antipolis
Valbonne - FRANCE
Tel.: +33 4 92 94 42 00 Fax: +33 4 93 65 47 16
Siret N° 348 623 562 00017 - NAF 742 C
Association à but non lucratif enregistrée à la
Sous-Préfecture de Grasse (06) N° 7803/88

X.400

c= fr; a=atlas; p=etsi; s=secretariat

Internet

secretariat@etsi.fr
<http://www.etsi.fr>

Copyright Notification

Reproduction is only permitted for the purpose of standardisation work undertaken within ETSI.
The copyright and the foregoing restrictions extend to reproduction in all media.

© European Telecommunications Standards Institute yyyy.
All rights reserved.

Contents

1. Intellectual Property Rights	5
2. Foreword.....	5
3. Introduction.....	5
4. Scope.....	5
5. References.....	5
6 Definitions and abbreviations.....	5
6.1. Definitions.....	5
6.2. Abbreviations	6
7 Working assumptions	7
7.1 General	7
7.2 Iu Interface.....	7
7.2.1 Packet buffering in SRNC and transmission of not yet acknowledged downstream packets at SRNC relocation	8
7.3 UMTS Mobility Management (UMM)	8
7.3.1 Location Management and Mobility Management concept overview	8
7.3.2 Description of the Location Management and Mobility Management Concept	12
7.3.3 MM functionality in different UE service states.....	13
7.3.4 The RRC state machine	14
7.3.5 Relationship between CS and PS service states and RRC state for an UE.....	15
7.3.6 Service registration and location update.....	16
7.3.7 Paging initiated by CN	17
7.3.8 Signalling connection establishment	17
7.3.9 Relations between SRNS relocation and Location registration	18
7.3.10 Requirements on Identifiers for UMTS and GSM.....	19
7.3.11 Use of TMSI signature.....	20
7.3.11 Signalling procedures	22
7.3.12 Combined update towards the HLR for a combined 3G-(MSC/VLR+SGSN) configuration	35
7.4. UMTS call control.....	39
7.4.1 Technical Requirements	39
7.5 Core network layer 3.....	39
7.6 Alternate Access technologies to UTRAN	40
7.6.1 Advantages of attaching HIPERLAN 2 to UMTS	40
7.6.2 HIPERLAN 2 UMTS Interworking	40
7.6.3 Related Actions	41
8. 0 UMTS Concepts	41
8.1 Reduction of UMTS signalling.....	41
8.1.1 GLR Concept.....	41
8.1.2. Super-Charger.....	42
9 Key issues	45
9.1 Core network transport.....	45
9.2 Core network layer 3	45
9.3 Benefits of the Gs interface applied to UMTS.....	45
9.4 Authentication	47
9.5 Management of ciphering keys.....	47
9.5.1 Cipher Mode Control – 2MM concept	47
9.5.2 UMTS-GSM handover	49
9.5.3 Interworking with 2g-MSC.....	49
9.6 Mobile IP in UMTS	49
9.6.1. Mobility Support	49
9.6.2 Mobile IP.....	49
9.6.3 A staged introduction of Mobile IP in the UMTS CN.....	50

9.6.4 Roaming	53
9.6.5 Mobile IP and UMTS terminals.....	53
9.6.6 Surrogate Registrations.....	53
9.7 Structure of air interface layer 3	54
9.8 Iu reference point.....	54
9.8.1 General	54
9.8.2 Control structure for the Iu reference point.	54
9.8.3 Iu reference point - User plane towards IP domain.....	54
9.8.4 Proposals for the User Plane for the IP Domain	55
9.9 Dualmode operation (GSM/UMTS)	56
9.9.1 Will dualmode terminals also support GPRS?.....	56
9.10 Anchor concept.....	59
9.10.1 Introduction to the concept of anchoring communications in GPRS.....	59
9.10.2 The Anchor SGSN concept	60
9.10.3 The non-Anchor SGSN concept	61
9.10.4 Analysis and comparison of the “anchor SGSN” and “non-anchor SGSN” concepts	62
9.10.5 Support of QoS requirements	62
9.11 Quality of service.....	64
9.12 Others	64
9.12.1 Evolved GPRS/IP support for Multi-media service.....	64
9.12.1 Separation of switching and control	65
9.13. New Handover functionalities	69
9.14 Reduction of UMTS signalling	69
9.14.2 Turbo Charger	69
9.14.3 Relationship between GLR and TurboCharger.....	72
9.15 Transcoder Control	72
9.16. Support of multimedia services	73
9.17. Support of services requiring variable bit rate.....	74
9.18 UMTS Simultaneous Mode.	74
10. Interoperability between GSM and UMTS	74
10.1 Circuit Switched Handover and Roaming Principles	75
10.2 Packet Switched Handover and Roaming Principles.....	77
10.2.1 Implications	77
11 Network Migration And Evolution	79
11.1 Network Migration Scenarios.....	79
11.2 network migration and evolution requirements	79
12 Protocol Architecture.....	80
12.1 I _u Signalling Bearer Requirements for IP Domain	80
12.1.1 Connectionless and Connection Oriented Services	80
12.1.2 Dynamic Bandwidth Allocation	80
12.1.3 Reliable Transfer	80
12.1.4 Flow Control.....	80
12.1.5 Redundancy and Load Sharing.....	80
12.1.6 Large Pdu Size.....	80
12.1.7 Signalling Bearer Management	80
12.1.8 Transport Media Independence	80

1. Intellectual Property Rights

2. Foreword

3. Introduction

4. Scope

This document is examining issues related to the evolution of the GSM platform towards UMTS with the overall goal of fulfilling the UMTS service requirements, the support of the UMTS role model, support of roaming and support of new functionality, signalling systems and interfaces.

5. References

This ETS incorporates, by dated and undated reference, provisions from other publications. These normative references are cited at the appropriate places in the text and the publications are listed hereafter. For dated references, subsequent amendments to or revisions of any of these publications apply to this ETS only when incorporated in it by amendment or revision. For undated references the latest edition of the publication referred to applies.

1. ETSI TC-SMG UMTS 22-01: "Services Principles"
2. ETSI TC-SMG GSM 03.02
3. ETSI TC-SMG GSM 03.60
4. ETSI TC-SMG GSM 11.14
5. ETSI TC-SMG GSM 30.01
6. ETSI TC-SMG GSM 23.01.
7. TG.3x6.
8. UMTSYY.01, UE-UTRAN Radio Interface Protocol Architecture – Stage 2
9. UMTSYY.03, Description of UE states and Procedures in Connected Mode

6 Definitions and abbreviations

6.1. Definitions

The following definitions have been introduced within this document.

Editors note : Reference to Definition document required.

6.2. Abbreviations

For the purposes of this ETS the following abbreviations apply.

7 Working assumptions

Section 7 is considered as relatively stable within SMG12, therefore interested groups are encouraged to use section 7 as an agreed SMG12 input to their work.

7.1 General

The phase 1 UMTS/Release '99 GSM standards should provide the capability to support:

- a core network based on an evolved 2G MSC and an evolved SGSN
- an optionally evolved Gs interface
- class A GSM⁺ mobiles.
- Transcoder location shall be according to 23.30
- UMTS/IMT2000 Phase1 (Release 99) network architecture and standards shall allow the operator to choose between Integrated and Separated core networks for transmission (including L2)
- The UMTS standard shall allow for both separated and combined MSC/VLR and SGSN configurations.
- The UE shall be able to handle separated or combined MSCs and SGSNs.
- There can be several user planes to these CN nodes.

The following general concepts should be followed :

- Separate the layer 3 control signalling from the layer 2 transport discussion (do not optimise layer 3 for one layer 2 technology).
- MSC-MSC layer 3 call control is out of scope of standardisation in SMG.
- As future evolution may lead to the migration of some services from the CS-domain to the PS-domain without changes to the associated higher-layer protocols or functions. UMTS release 99 shall provide the flexibility to do this in a way that is backwards compatible with release 99 UEs provided this does not introduce significant new complexity or requirements in the system.

7.2 Iu Interface

- Transport protocol across the Iu interface for UTRAN shall be according to 23.30
- The UTRAN shall support two logically separate signalling flows via Iu to combined or separate network nodes of different types (MSC and SGSN).
- The UTRAN shall contain a "domain distribution function" to route transparent application-level control signalling from the UE to the correct core network domain. The UE shall indicate the type of application being addressed (eg via a protocol discriminator). The UTRAN shall map this on to the correct Iu instance to forward the signalling.
- UTRAN-services (including radio access bearers) shall be independent from the core network domain used to access them. Either core network domain can access any appropriate UTRAN-service (eg it should be possible to access a "speech" radio access bearer from the PS-domain).

7.2.1 Packet buffering in SRNC and transmission of not yet acknowledged downstream packets at SRNC relocation

Due to the bursty nature of IP traffic and due to the limited amount of downstream radio resources, some (large) buffering capacity is needed in the network to absorb the traffic peaks that arrive as there are not enough radio resources to send them to the UE(s). Only this kind of buffering is considered in the rest of this section.

Large buffering capacity in both CN and SRNC would add to the:

- cost of the network (duplication of memory resources)
- transit delay (packets may have to stay in 2 large queues)
- complexity of the system (coordination between CN and SRNC for buffer management and associated packet scheduling according to QoS)

As a consequence such (large) buffers should only be put in one place (CN or SRNC).

RNC-UE procedures (ARQ RLC) ensure data reliability as long as SRNS relocation or GSM <-> UMTS Hand-Over are not needed. Large buffering capacities as well as procedures to ensure data reliability at SRNS relocation and GSM <-> UMTS Hand-Over (transmission between old and new nodes of downstream packets not yet acknowledged by the UE) should be put where ARQ procedures are located.

Hence an acknowledgement layer (e.g. LLC in 2G networks) is not needed between CN and UE because data reliability is provided between UE and SRNC. In case of SRNS relocation or GSM <-> UMTS Hand-Over, transmission of not yet acknowledged downstream packets between (old and new) SRNC or between SRNC and 2G-SGSN provide the necessary reliability.

Hence large buffers to absorb peaks of downstream traffic as well are not needed in the CN and no flow control between CN and UTRAN needs to be defined in order to control the IP domain user plane flow.

7.3 UMTS Mobility Management (UMM)

- From a logical point of view, the CN encompasses two domains, a PSTN/ISDN domain and an IP domain. It shall be possible to connect the UTRAN either to both these CN domains or to one of the CN domains.
- A single RRC connection (between UTRAN and UE) shall carry all user plane and signalling flows to/from a UE. This is regardless of where in the CN they originate/terminate.
- UMTS shall support compatibility with GSM network from the point of view of roaming and handover. For the LM/MM functionality point of view this implies among other things the following:
 - a) IMSI shall be used as the common user identity in the two CN domains.
 - a) Common MAP signalling will be applied to both GSM and UMTS. The GSM MAP mobile service operations shall be evolved and re-used as far as possible (including extensions if required). This should not stop new MAP signalling operations being developed and applied to both GSM and UMTS.
 - b) Radio network parameters and radio resource management should be isolated in the UTRAN.
- The LM/MM techniques used in UMTS should minimise radio resource usage of the UTRA

7.3.1 Location Management and Mobility Management concept overview

From a logical point of view, the Core Network (CN) consists of two service domains, a CS service domain (earlier named PSTN/ISDN domain) and a PS service domain (earlier named IP domain) or one of these domains.

Each service domain has its own service state machine. An UE, that is supporting both CS services and PS services, has a CS service state machine and a PS service state machine. The two peers of the service state machine are working

independently to each other, although associated to the same UE. The UE-CN signalling aims to keep the peer entities synchronised.

As an introduction, Figure 1 and Figure 2 below give an overview of the UE registration and connection principles within the UMTS when the CN consists of two separate PS and CS service nodes or one combined CS and PS service node.

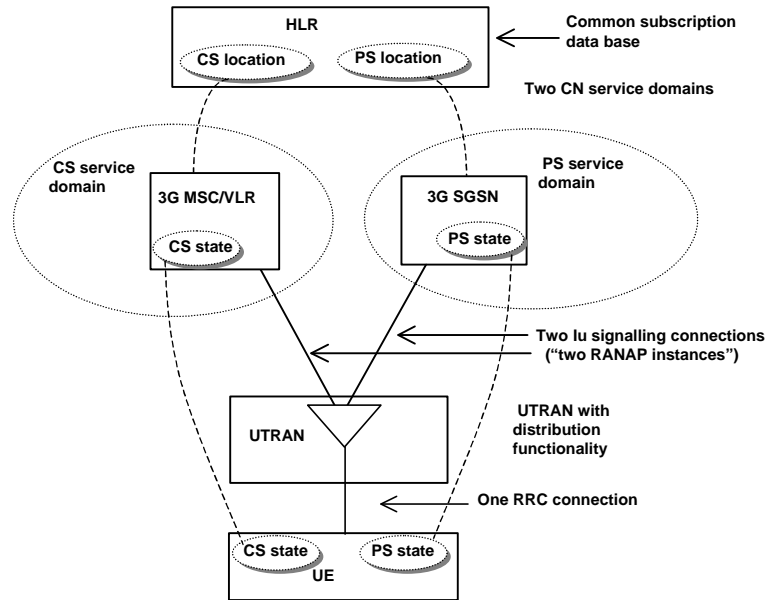

Figure 1: Overview of the UE registration and connection principles within UMTS for the separate CN architecture case when the CN consists of both a CS service domain with evolved MSC/VLR, 3G_MSC/VLR, as the main serving node and an PS service domain with evolved SGSN/GGSN, 3G_SGSN and 3G GGSN, as the main serving nodes,

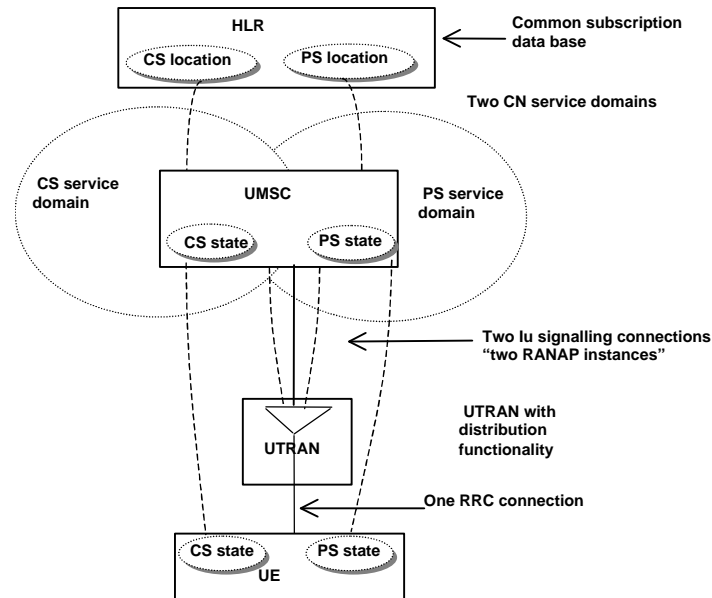

Figure 2: Overview of the UE registration and connection principles within UMTS for the integrated CN architecture case when the CN consists of both a CS service domain and a PS service domain with an UMSC as the main serving node.

The main PS service states are PS-DETACHED, PS-IDLE and PS-CONNECTED. The main CS service states are CS-DETACHED, CS-IDLE and CS-CONNECTED. For the respective service domain there are specific related MM system information controlling the Mobility Management functionality of the UE

The aim of UTRAN is to offer one unified set of radio bearers which may be used for bursty packet traffic and for traditional telephony traffic. This leads to the conclusion that only one logical control channel structure will be used for all kind of traffic. The radio resource handling is UTRAN internal functionality and the CN does not define the type of radio resource allocated.

The Radio Resource Control (RRC) has two modes, RRC Connected mode and RRC Idle mode. The RRC mode describes which identity is used to identify the UE. In RRC Idle mode the UE is identified by a CN associated identity. In RRC Connected mode the UE is assigned a Radio Network Temporary Identity to be used as UE identity on common transport channels. When the UE is allocated dedicated transport channels, it uses the inherent addressing provided by these transport channels.

In PS-CONNECTED state the UE is in RRC Connected mode. In CS-CONNECTED state the UE is in RRC Connected mode.

For the mobility functionality, four different area concepts are used. Location Areas and Routing Areas are used in the Core Network. UTRAN Registration Areas and Cell Areas are used in UTRAN. Location Areas are related to CS services. Routing Areas are related to PS services.

One Location Area is handled by one CN node. For an UE that is registered in a Location Area, this implies that the UE is registered in the specific CN node handling this specific Location Area. One Routing Area is handled by one CN node. For an UE that is registered in a Routing Area, this implies that the UE is registered in the specific CN node handling this specific Routing Area. Location Area is used by the 3G_MSC/VLR for paging the UE. Routing Area is used by the 3G_SGSN for paging the UE. UTRAN Registration Areas and Cell Areas are only visible in UTRAN and used in RRC-Connected mode.

For the relations between Location Area (LA) and Routing Area (RA) it shall be possible for the operator to have a LA and a RA equal (i.e. same cells), a RA as a part of a LA, a LA as a part of RA, and LA and RA independent. In case of a LA and RA consisting of both UMTS cells and GSM cells the GSM defined relations will apply.

In RRC Idle mode it is the broadcasted MM system information (e.g. information about the present Location Area and present Routing Area) that determines when the UE initiates a location registration procedure towards the CN. An UE in state CS-IDLE will in RRC Idle mode, initiate Location Area update towards the CN when crossing LA border. An UE in state PS-IDLE will in RRC Idle mode initiate Routing Area update towards the CN when crossing RA border.

In RRC Connected mode, the UE receives the MM system information on the established RRC connection. (I.e. the broadcasted MM system information is not used by the UE in the RRC connected mode.) An UE in state CS-IDLE will, in RRC Connected mode, initiate Location Area update towards the CN when receiving information indicating a new Location Area. An UE in state PS-IDLE will, in RRC Connected mode, initiate Routing Area update towards the CN when receiving information indicating a new Routing Area. An UE in state CS-CONNECTED will, in RRC Connected mode, not initiate Location Area update towards the CN. An UE in state PS-CONNECTED will, in RRC Connected mode, not initiate Routing Area update towards the CN.

In CS-DETACHED mode the UE will not initiate any Location Area update and this independent of the RRC mode. In PS-DETACHED mode the UE will not initiate any Routing Area update and this independent of the RRC mode.

In addition to normal location registration when changing registration area, the UE may (network options) perform CS periodic registration when in CS-IDLE state and PS periodic registration when in PS-IDLE state. The respective periodic registration may be on/off on Location Area respective Routing Area level.

On the Mobility Management level, IMSI and CS related TMSI are used as UE identities in the CS service domain, and IMSI and PS related TMSI are used as UE identities in the PS service domain. The IMSI is the common UE identity for the two CN service domains.

A signalling connection between the UE and the CN refers to a logical connection consisting of an RRC connection between UE and UTRAN and an Iu signalling connection ("one RANAP instance") between the UTRAN and the CN node. The CS service domain related signalling and PS service domain related signalling uses one common RRC connection and two Iu signalling connections ("two RANAP instances"), i.e. one Iu signalling connection for the CS service domain and one Iu signalling connection for the PS service domain.

7.3.1.1 Use of combined procedures for UMTS

The use of separated PS and CS mobility mechanisms within the UE and within the CN may lead to non-optimal usage of the radio resource (for example a UE in PS idle and CS idle state would perform both location updates (for the CS mechanism) and Routing area updates (for PS mechanisms)).

UMTS should optimise the use of radio resources. The use of combined updates (similar to the current GSM/GPRS Gs combined update mechanism) may enable this. To offer flexibility in the provision of mobility management for UMTS, it should be possible to use combined mechanisms for location management purposes as well as for attach/detach status purposes.

From the UE perspective it should be possible for the UE to perform combined update mechanisms (operator option). UMTS Phase 1 R99 terminals should support the use of both combined and separate mechanisms. The support of this feature by all UMTS mobiles will also ease evolution of UMTS MM in the future.

In the UMTS specifications the RAN will not co-ordinate mobility management procedures that are logically between the core network and the MS. This includes: location management, authentication, temporary identity management and equipment identity check.

The issues of security, temporary identifiers, CS and PS periodic registrations and PS DETACHED/CS DETACHED need to be studied.

7.3.2 Description of the Location Management and Mobility Management Concept

7.3.2.1 Area concepts

For the mobility functionality four different area concepts are used. Location Area and Routing Area in the CN as well as UTRAN Registration Area and Cell areas in the UTRAN.

7.3.2.1.1 Location areas

For CS services, the CN uses Location Areas (LA). Location Area is used e.g. at CN initiated paging related to CS services. A CS service related temporary identity, CS-TMSI, may be allocated to the UE. This temporary identity is then unique within a LA.

7.3.2.1.2 Routing areas

For PS services, the CN uses Routing Areas (RA). Routing Area is used e.g. at CN initiated paging related to PS services. A PS service related temporary identity, PS-TMSI, may be allocated to the UE. This temporary identity is then unique within a RA.

Note that the routing area concept here differs from the routing area in GSM, which in a sense corresponds to URA (see below) in UMTS.

7.3.2.1.3 UTRAN internal areas

UTRAN internal areas are used when the terminal is in RRC-Connected mode (see chapter 3.3). The areas are used at e.g. UTRAN initiated paging. UTRAN internal area updating is a radio network procedure and the UTRAN internal area structure should not be visible outside UTRAN. In RRC connected mode, the UE position is known on cell level or on UTRAN Registration Area (URA) level. RNTI is used as a temporary UE identifier used within UTRAN and allocated at RRC connection establishment. Note that the URA thus corresponds, in a sense, to the routing area in GSM.

7.3.2.1.4 Relationship between the different areas

The following area relations exist:

- 1) One URA consists of a number of cells. The cells normally belong to the same RNC, but this assumption may not be a requirement (ffs.).
- 2) One RA consists of a number of URA:s belonging to RNC:s that are connected to the same CN node.
- 3) One LA consists of a number of URA:s belonging to RNC:s that are connected to the same CN node.
- 4) One RA is handled by only one CN serving node, i.e. one UMSC or one 3G_SGSN.
- 5) One LA is handled by only one CN serving node, i.e. one UMSC or one 3G_MSC/VLR.
- 6) There may not be any relation between LA and RA, i.e. the following relations between LA and RA are possible:
 - RA and LA is equal
 - one RA is a subset of one, and only one, LA, meaning that a RA do not span more than one LA
 - one LA is a subset of one, and only one, RA, meaning that a LA do not span more than one RA
 - independent LA and RA structure

In case of a LA and a RA consisting of both UMTS cells and GSM cells, then the GSM defined relations will apply.

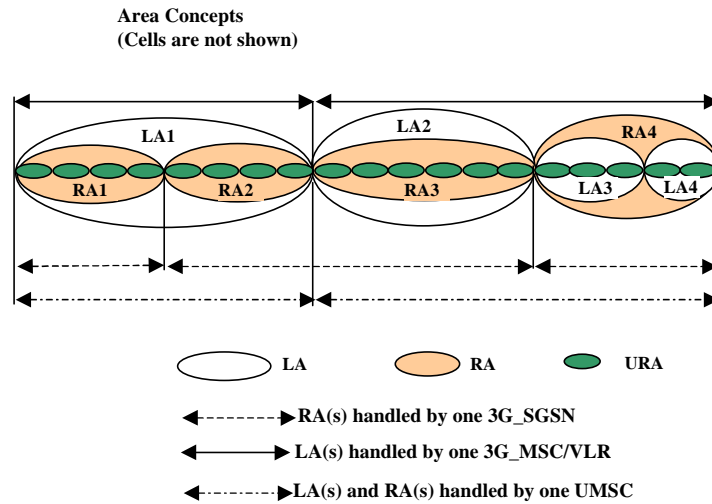

Figure 3: Relationship between different areas. The totally independent LA and RA structure is not described in this figure.

7.3.3 MM functionality in different UE service states

Below are the main UE service states and related MM functionality described. For the determination on when LA or RA is changed, see chapter on “Handling of MM system information”.

CS service states and related MM functionality:

- 1) CS-DETACHED: The UE is not reachable by the network for CS services. The UE does not initiate LA updates at LA changes and no periodic CS service updates.
- 2) CS-IDLE: The UE is reachable by paging for CS services. The UE initiates LA updates at LA changes. The UE may initiate periodic CS service updates and this depending on the CS periodic update state of the present LA.
- 3) CS-CONNECTED: The UE has a signalling connection for CS services established between the UE and the CN. The UE does not initiate LA update (even not when the present LA changes) and no periodic CS service updates.

PS service states and related MM functionality:

- 1) PS-DETACHED: The UE is not reachable by the network for PS services. The UE does not initiate RA updates at RA changes and no periodic PS service updates.
- 2) PS-IDLE: The UE is reachable by paging for PS services. The UE initiates RA updates at RA changes. The UE may initiate periodic PS service updates and this depending on the PS periodic update state of the present RA.
- 3) PS-CONNECTED: The UE has a signalling connection for PS services established between the UE and the CN. The UE does not initiate RA update (even not when the present RA changes) at RA changes and no periodic PS service updates.

There may also be a NULL state. In the UE, this state corresponds to power off or maybe a “no SIM” condition. In the CN, the NULL state correspond to CS-DETACHED and PS-DETACHED

For each state transition there can be several events that triggers the transition. Some of them are described below. Note that some of these may coincide, e.g. moving from CS-IDLE to CS-DETACHED and moving from PS-IDLE to PS-DETACHED.

Moving from CS-IDLE to CS-CONNECTED:

The state transition from CS-IDLE to CS-CONNECTED is performed when a signalling connection is established between UE and CN for CS services. In GSM this state transition is triggered by the message CM_SERVICE_REQUEST or PAGE_RESPONSE.

Moving from CS-CONNECTED to CS-IDLE:

The state transition from CS-CONNECTED to CS-IDLE is performed when the signalling connection for CS services is released, e.g. at call release and no other CS service is ongoing. A radio link failure may also trigger this state transition.

Moving from CS-IDLE to CS-DETACHED:

The transition from CS-IDLE to CS-DETACHED may be triggered by some action from the user of the UE but an expiring timer in the network could also trigger it. The UE is marked as CS_DETACHED in the CN and then as a consequence no CS service establishment is possible.

Moving from PS-IDLE to PS-CONNECTED:

The state transition from PS-IDLE to PS-CONNECTED is performed when a signalling connection is established between UE and CN for PS services.

Moving from PS-CONNECTED to PS-IDLE:

The state transition from PS-CONNECTED to PS-IDLE is performed when the signalling connection for PS services is released, e.g. at release of a PS service and no other PS service is ongoing. A radio link failure may also trigger this state transition.

Moving from PS-IDLE to PS-DETACHED:

The transition from PS-IDLE to PS-DETACHED may be triggered by some action from the user of the UE but an expiring timer in the network could also trigger it. The UE is marked as PS_DETACHED in the CN and then as a consequence no PS service establishment is possible.

7.3.4 The RRC state machine

The RRC state machine is a description model of how the UE and the UTRAN co-operate regarding RRC functionality. The RRC state describes the state of the UE in the UTRAN. Here follows a brief description of the RRC state machine, for more information see [UMTS YY.01] and [UMTS YY.03].

Note: RRC idle mode and RRC connected mode refer to the UE idle mode and UE connected mode respectively in [UMTS YY.01] and [UMTS YY.03].

The RRC state machine exists as peer entities, one in the UE and one in UTRAN. Apart from transient situations and error cases they are synchronised. The figure below illustrates the main modes/states of the RRC state machine.

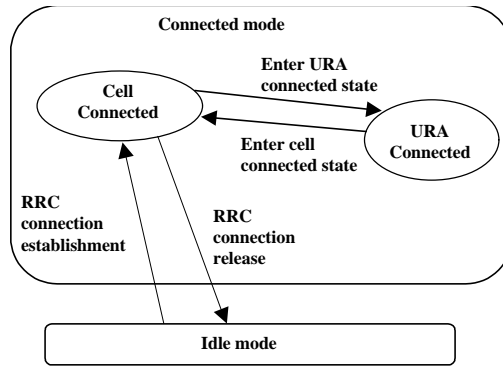

Figure 4: RRC modes, main RRC states and main mode/state transitions

RRC-Idle_mode

In the Idle mode there is no connection established between UE and UTRAN. There is no signalling between UTRAN and the UE except for system information that is sent from UTRAN down link on a Broadcast channel to the UE. The UE can also receive paging messages with a CN identity on the PCH. There is no information on the UE stored in UTRAN in this state.

RRC-Connected_mode

In the Connected mode the main states are Cell Connected state and URA connected state. In this mode there is one RNC that is acting as Serving RNC (SRNC), and an RRC connection is established between the UE and this SRNC.

- When the UE position is known on cell level, the UE is in the cell connected state. When in cell connected state, the RRC connection mobility is handled by handover procedures.
- When the UE position is known on URA level, the UE is in the URA connected state. The URA contains a set of cells. URA updating procedures provides the mobility functionality in this state. In URA connected state no dedicated radio resources are used.

7.3.5 Relationship between CS and PS service states and RRC state for an UE

During non-transient conditions the following relations are valid between service states and RRC modes for an UE:

When in either CS-CONNECTED state or PS-CONNECTED state, or in both CS-CONNECTED state and PS-CONNECTED state, then the UE is in RRC connected mode.

When in neither CS-CONNECTED state nor PS-CONNECTED state, then the UE is in RRC idle mode.

~~RRC idle mode ⇔ CS IDLE or CS DETACHED~~

~~RRC idle mode ⇔ PS IDLE or PS DETACHED.~~

~~RRC connected mode ⇔ CS CONNECTED~~

~~RRC connected mode ⇔ PS CONNECTED~~

Figure 5 and Figure 6 illustrate two examples on the relations between the RRC states and CS/PS service states. These figures illustrate the separated CN case.

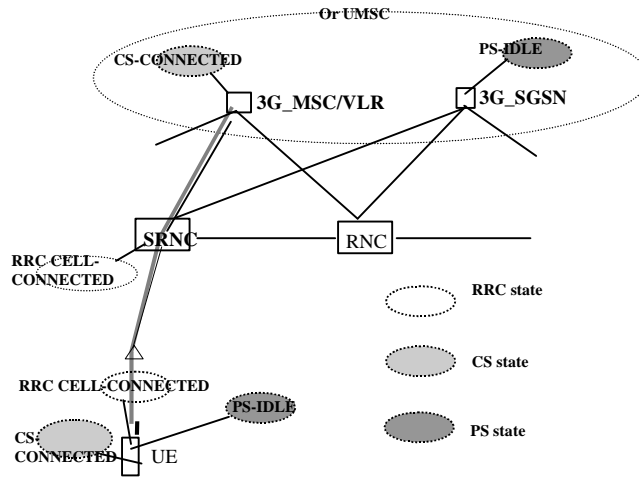

Figure 5: UE in CS-CONNECTED state and PS-IDLE state.

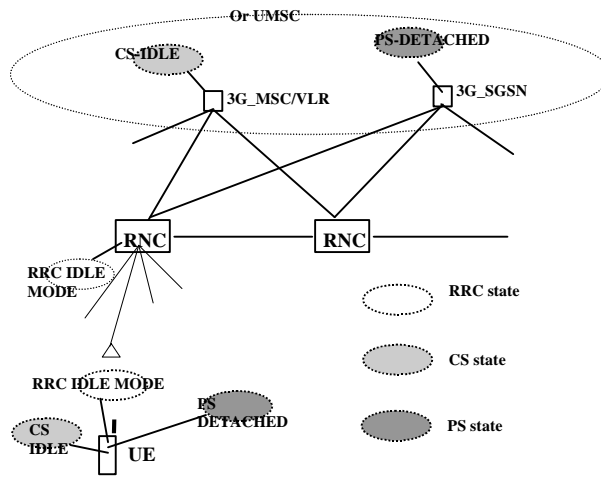

Figure 6

7.3.6 Service registration and location update

Service registration (attach) in the respective CN service domain is done initially (after UE being detached due to e.g. power off). When a registration area is changed a location update is performed. In addition, periodic registration can be performed. Here follows descriptions of when the respective CN registration area is changed. Note it is not here defined which different registration procedures that are needed.

7.3.6.1 Location area update

Location area update is initiated by the UE to inform the CS service domain of the core network that the UE has entered a new location area. In case the new location area is in an area served by another CN node, the location area update also triggers the registration of the subscriber in the new CN node and a location update for CS services towards the HLR.

Location area update is only initiated by the UE when the UE is in state CS-IDLE, and this independently of the PS state. If the UE is CS-IDLE but RRC connected, which means that the UE is in PS-CONNECTED state, location area update is initiated by the UE when it enters a new location area (see also the chapter "Handling of MM system information").

7.3.6.2 Routing area update

Routing area update is initiated by the UE to inform the PS service domain of the core network that the UE has entered a new routing area. In case the new routing area is in an area served by another CN node, the routing area update also triggers the registration of the subscriber in the new CN node and a location update for PS services towards the HLR.

Routing area update is only initiated by the UE when the UE is in state PS-IDLE, and this independently of the CS state. If the UE is PS-IDLE but RRC connected, which means that the UE is in CS-CONNECTED state, routing area update is initiated by the UE when it enters a new routing area (see also the chapter "Handling of MM system information").

7.3.6.3 Combined updates

The GSM radio interface combined procedures and their support via the Gs interface is the starting point for the support of combined updates..

7.3.7 Paging initiated by CN

Here follows a possible solution with a page co-ordination within the UTRAN. Other alternatives are possible.

- A CN node requests paging only for UE in CS-IDLE state or PS IDLE state. In the separate CN architecture, paging from a CN node is done independent of the service state of the UE in the other CN service domain.
- In this alternative with page co-ordination in UTRAN, the UE does not need to listen to the PCH (Page Channel) in RRC connected mode. (At least not when UE is allocated a dedicated channel.)
- At each page request received from a CN node, the RNC controls whether the UE has an established RRC connection or not. For this, the context that is build up in the SRNC for UE in RRC connected mode must contain the IMSI, i.e. the UE identity common for the two CN domains.
- If no context is found for the UE, "normal PCH paging" is performed. This implies transfer on the Paging channel of a page message indicating the UE paging identity received from the CN and a CN service domain type indication.
- If a context is found, a "CN paging message" is transferred using the existing RRC connection. This message indicates then the UE paging identity received from the CN and a CN service domain type indication.
- In case of a single CN element, paging may be (but not mandatory) co-ordinated at the CN.

Note: The RNC might use another identity e.g. TMSI, P-TMSI, or other radio related identity, to page the mobile.

7.3.8 Signalling connection establishment

A signalling connection between the UE and a CN node refers here to a logical connection consisting of an RRC connection between UE and UTRAN and an Iu signalling connection between UTRAN and the CN node. The signalling connection is used for transfer of higher layer (MM, CM) information between the UE and the CN node.

At a CM service request to one of the CN service domains, UE will only request establishment of a new signalling connection when no such connection exists towards the applicable CN service domain.

If no RRC connection exists, this is established in conjunction with (before) the transfer of the signalling establishment request. At the RRC connection establishment, an UE context is built up in the SRNC.

If an RRC connection is already established, the UE will send the signalling establishment request using that RRC connection.

At reception of the signalling establishment request, the SRNC will establish an Iu connection towards the CN node indicated by the CN service domain type received from UE.

7.3.9 Relations between SRNS relocation and Location registration

This chapter is included in order to clarify the need for separate handling of MM registration area (LA and RA) information in RRC idle mode respective in RRC connected mode. The following example illustrates relations between SRNC relocation, registration area (LA/RA) change and location/routing area updates. As shown in the example, this is equally applicable for a UMSC as well as the 3G-MSC/VLR and 3G-SGSN.

Note that the example is based on the assumptions that one RNC can set up Iu connections to only one 3G_MSC/VLR (or UMSC) and only one 3G_SGSN (or UMSC), and that the CN node is configured to only send page to the RNC(s) that is controlling cells within the relevant LA/RA

Preconditions:

- LA1 (Location Area 1) is handled by 3G_MSC/VLR1 (or UMSC1) and LA2 is handled by 3G_MSC/VLR2 (or UMSC2)
- RA1 (Routing Area 1) is handled by 3G_SGSN1 (or UMSC1) and RA2 is handled by 3G_SGSN2 (or UMSC2)
- UE is registered in LA1 in 3G_MSC/VLR1 and in RA1 in 3G_SGSN1
- The UE is in PS-CONNECTED state and a signalling connection exists between UE and 3G_SGSN1
- The UE is in CS-IDLE state and no signalling connection exists between UE and 3G_MSC/VLR1
- RNC1 is acting as SRNC and RNC2 is acting as DRNC
- UE is in RRC cell connected state and with dedicated channels established to cells within both RNC1 and RNC2. UE does not listening to the PCH.
- The registration area information sent to the UE indicates LA1 and RA1

The UE can always (at least in normal working states) identify the present available registration area (LA respective RA) associated with the respective CN service domain. The determination of the present area differs depending on the state of the UE. For UE in RRC idle mode (UE with no ongoing communication with the network) it is the cell selection mechanism in the UE that is used. For UE in RRC connected mode it is the UTRAN that determines the area (although a change can implicit be initiated by the UE).

It is the network that supplies the MM system information to the UE. For UE in RRC idle mode the MM system information is provided by the system information broadcasting function. For UE in RRC connected mode, the MM system information is supplied by the SRNC to the UE at each change of this information. This leads to that in RRC connected mode, the MM registration area (e.g. LA and RA) information sent on broadcast channel is not used.

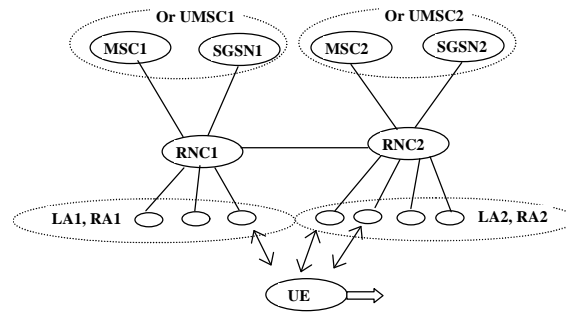

Figure 7: Illustration of the preconditions in the described example. In this figure MSC stands for 3G_MSC/VLR and SGSN for 3G_SGSN.

The UE moves now further towards right, leaving the coverage area of cells controlled by RNC1, and resulting in that the UE has dedicated channel(s) established to cell(s) within only RNC2. This may result in the following sequence of events:

- The SRNC (RNC1) may decide to perform an SRNC relocation resulting in that the RNC2 becomes SRNC. The change of SRNC will in this example also imply a change of SGSN (or UMSC) with an update of the UE location registration for the PS service domain.
- After this SRNC relocation or combined with this procedure, the MM registration area information sent to the UE is changed and indicates now LA2 and RA2. (Note that the MM registration area information need not be sent for every SRNS relocation, nor does it preclude MM registration area information being sent in other occasions.)
- The changed MM registration area information will result in that the UE initiates a location update, which results in a registration change from LA1 in 3G_MSC/VLR1 to LA2 in 3G_MSC/VLR2.

The area information can not be changed to indicate LA2 unless SRNC relocation has been performed. This since the location update signalling will be sent from the UE, by using the established RRC connection to SRNC, and then to the 3G_MSC/VLR to which the SRNC belongs.

7.3.10 Requirements on Identifiers for UMTS and GSM

1a) The format of the UMTS Location Area Identifier and UMTS TMSI shall not prevent a dual mode GSM-UMTS mobile which was last location updated over the GSM radio interface (i.e. has a GSM LAI and GSM TMSI), from performing a location update (or other signalling) over the UMTS radio interface to a UMTS MSC.

1b) The format of the UMTS Location Area Identifier and UMTS TMSI shall not prevent a dual mode GSM-UMTS mobile which was last location updated over the UMTS radio interface (i.e. has a UMTS LAI and UMTS TMSI), from performing a location update (or other signalling) over the GSM radio interface to a GSM MSC.

1c) The format of the UMTS Routing Area Identifier and UMTS P-TMSI shall not prevent a dual mode GSM-UMTS mobile which was last routing area updated over the GSM radio interface (i.e. has a GSM RAI and GSM P-TMSI), from performing a routing area update (or other signalling) over the UMTS radio interface to a UMTS SGSN.

1d) The format of the UMTS Routing Area Identifier and UMTS P-TMSI shall not prevent a dual mode GSM-UMTS mobile which was last routing area updated over the UMTS radio interface (i.e. has a UMTS RAI and UMTS P-TMSI), from performing a routing area update (or other signalling) over the GSM radio interface to a GSM SGSN.

2) The standard shall support means by which an operator can configure GSM and UMTS cells to be members of the same registration area (i.e. the mobile can receive paging from whichever cell it is camped on and does not need to location update (or routing update) just because the mobile has changed from a UMTS to a GSM cell).

- 3a) The standard shall support means by which an operator can allocate GSM and UMTS LAIs which enable GSM MSCs to be able to contact UMTS MSCs and vice versa.
- 3b) The standard shall support means by which an operator can allocate GSM and UMTS RAIs which enable GSM SGSNs to be able to contact UMTS SGSNs and vice versa.
- 4) The standard shall support means by which an operator can ensure that the IMSI does not need to be sent over the radio interface when the mobile station moves from a GSM cell to a UMTS cell (and vice-versa).
- 5) The standard shall support means by which an operator can ensure that the IMSI does not need to be sent over the radio interface when a USIM is moved from a UMTS mobile station to a GSM mobile station (and vice-versa).
- 6) The standard need not support means by which an operator can ensure that the IMSI is not sent over the radio interface when a GSM SIM is moved from a GSM mobile station to a UMTS mobile station (and vice-versa).

7.3.11 Use of TMSI signature

The TMSI signature concept would mainly be used during the IMSI attach procedure and during the location update procedure. (The former may invoke the latter) However, it may also be used in almost all cases when authentication is performed e.g. call setup. Note that if the TMSIS is sent in the clear, then a new one should be issued.

As the use of a P-TMSI signature is already defined within GPRS, only the modifications necessary for CS service domain shall be shown below.

7.3.11.1 IMSI attach

Figure 1 shows the signalling procedure for a first time (IMSI based) attach (i.e. when no TMSI is available in the UE). The following list explains the relevant steps involved in the procedure.

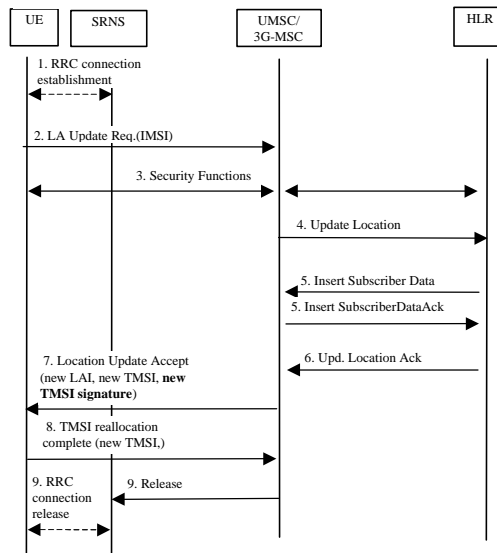

Figure 8: Attach Procedure using TMSI signature

- 1). An RRC connection is established.

2). Upon the very first attach towards the network, the MS shall send a Location Area Update Request message towards the MSC/UMSC, indicating an IMSI attach, and identifying itself with IMSI.

2 – 6) The LA updating procedure shall be carried out as per normal within the network.

7). The MSC/UMSC shall optionally generate and send a TMSI signature within the Location Area Update Accept message to the MS, which will be stored by the MS.

8) The MS acknowledges the new TMSI.

9). The RRC connection may be released.

7.3.11.2 Location Area update

Figure 2 shows the signalling for a location update procedure involving change of 3G-MSC / UMSC. Note that when the authentication procedure using TMSI signature is successful, security functions using Ki are no longer required. The following list explains the relevant steps involved in the procedure.

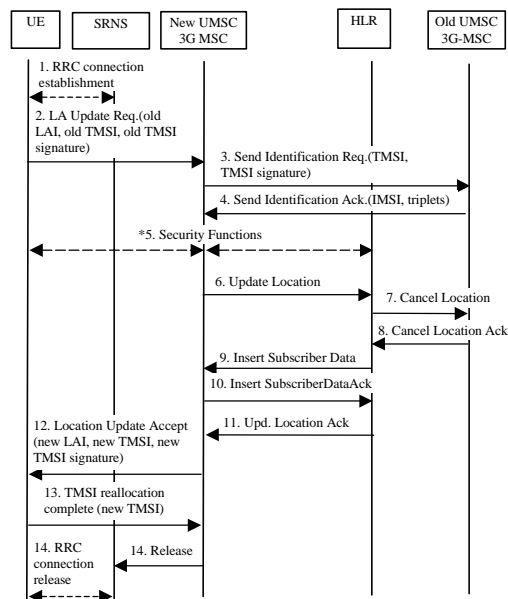

Figure 9: Location Update using TMSI signature

1) An RRC connection is established.

2) The UE shall send a Location Area Update Request (old LAI, old TMSI, old TMSI signature) towards the new UMSC/MSC.

3-5) The new UMSC/MSC shall send a Send Identification Request (TMSI, TMSI signature) to the old UMSC/MSC. The old UMSC validates the old TMSI signature and responds with an appropriate error cause if it does not match the value stored. This should initiate the security function in the new UMSC. Otherwise, the old UMSC responds with a Send Identification Acknowledge (IMSI, Authentication triplets).

6-11) The LA updating procedure shall be carried out as per normal within the network.

12) The new UMSC/MSC shall optionally generate and send a TMSI signature within the Location Area Update Accept message to the UE.

13) The UE acknowledges the new TMSI.

14) The RRC connection may be released.

7.3.11.3 MM System Information

The system information that is needed for the Mobility Management functionality contains parameters such as:

MCC, MNC, LAC, RAC, Periodic Location Area Update timer, and Periodic Routing Area Update timer.

In each UMTS cell (UTRAN cell) the network broadcasts MM system information on the broadcast channel. In RRC idle mode, when the UE camps on one cell, it receives all MM system information valid for this cell on the broadcast channel of the cell. The received MM system information is then the "current MM system information".

In RRC connected mode, it is the responsibility of the SRNS to control the current MM system information valid for the UE. At any changes, the established RRC connection is used for transferring the new MM system information to the UE. E.g. at SRNS relocation, the new SRNS shall have logic for sending applicable MM system information to the UE. This information is determined by e.g. the Location Areas and the Routing Areas handled by the respective CN node to which the SRNS can set up Iu signalling connections. At reception of new MM system information from the SRNC on the established RRC connection, the UE uses this new information as the "current MM system information". (Note that the MM system information need not necessarily be sent for every SRNS relocation, nor does it preclude MM system information being sent on other occasions.)

At the RRC connection establishment, the UE uses the broadcasted MM system information of the cell where the establishment is made as the "current MM system information".

When the UE leaves the RRC connected mode and enters RRC idle mode, the UE uses the broadcasted MM system information of the chosen cell, which is determined by the UE idle mode cell selection/re-selection process that is then performed, as the "current MM system information".

The "current MM system information" is used by the MM functionality in the UE respecting the rules for the UE service state of the respective MM state machine, see ' 7.3.3 MM functionality in different UE service states ' and ' 7.3.6 Service registration and location update '.

7.3.11 Signalling procedures

7.3.11.1 Idle mode procedures

The signalling procedures shown in the following sections do not represent the complete set of possibilities, nor do they mandate this kind of operation. The standard will specify a set of elementary procedures for each interface, which may be combined in different ways in an implementation. Therefore these sequences are merely examples of a typical implementation. By default the combined procedures as defined in GSM 03.60 are also applicable when using Gs.

Furthermore the list of parameters may not be complete, but should only be seen as examples of possible information carried by the messages.

7.3.11.1.1 Location Area update

This example shows location registration when changing Location Area including change of 3G-MSC/VLR and when the UE is in MM idle state towards the 3G_MSC/VLR.

The illustrated transfer of MM signalling to/from the UE uses an established RRC connection. This RRC connection can have been established beforehand due to ongoing interwork between UE and 3G-SGSN or be established only for this location registration procedure towards the 3G_MSC/VLR.

For each indicated MM message sent in this case to/from UE, the CN discriminator indicates 3G_MSC/VLR.

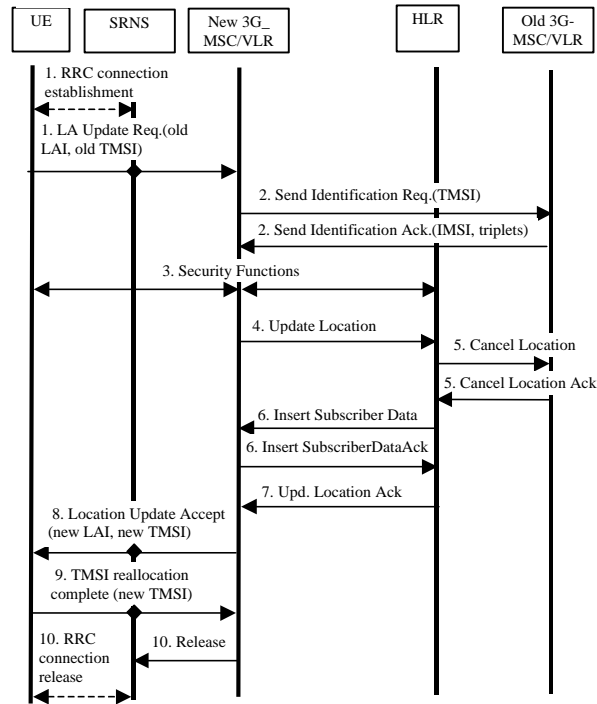

Figure 10: Interface information transfer for location update when changing VLR area

- 1) The RRC connection is established, if not already done. The UE sends the initial message Location Area Update Request (old TMSI, old LAI, etc.) to the new 3G_MSC/VLR. The old TMSI and the old LAI are assigned data in UMTS. The SRNS transfers the message to the 3G_MSC/VLR. The sending of this message to 3G_MSC/VLR will also imply establishment of a signalling connection between SRNS and 3G_MSC/VLR for the concerned UE. The 3G_MSC/VLR determines the new Location Area for the UE. Whether the 3G_MSC/VLR derives the new LAI from information supplied by the UE or by the SRNS is ffs.
- 2) The new 3G_MSC/VLR sends an Send Identification Request (old TMSI) to the old 3G_MSC/VLR to get the IMSI for the UE. (The old LAI received from UE is used to derive the old 3G_MSC/VLR identity/address.) The old 3G_MSC/VLR responds with Send Identification Ack. (IMSI and Authentication triplets).
- 3) Security functions may be executed.
- 4) The new 3G_MSC/VLR inform the HLR of the change of 3G_MSC/VLR by sending Update Location (IMSI, MSC address, VLR number) to the HLR.
- 5) The HLR cancels the context in the old 3G_MSC/VLR by sending Cancel Location (IMSI). The old 3G_MSC/VLR removes the context and acknowledges with Cancel Location Ack .
- 6) The HLR sends Insert Subscriber Data (IMSI, subscription data) to the new 3G_MSC/VLR. The new 3G_MSC/VLR acknowledges with Insert Subscriber Data Ack.
- 7) The HLR acknowledges the Update Location by sending Update Location Ack. to the new 3G_MSC/VLR.
- 8) The new 3G_MSC/VLR validates the UE presence in the new LA. If due to regional, national or international restrictions the UE is not allowed to attach in the LA or subscription checking fails, then the new

3G_MSC/VLR rejects the location area update with an appropriate cause. If all checks are successful, then the new 3G_MSC/VLR responds to the UE with Location Area Update Accept (new TMSI, new LAI).

- 9) The UE acknowledges the new TMSI with a TMSI reallocation Complete. (TMSI can optionally be reallocated with the TMSI reallocation procedure).
- 10) When the location registration procedure is finished, the 3G_MSC/VLR may release the signalling connection towards the SRNS for the concerned UE. The SRNS will then release the RRC connection if there is no signalling connection between 3G_SGSN and SRNS for the UE.

7.3.11.1.2 Routing Area update

This example shows location registration when changing Routing Area including change of 3G_SGSN when the UE is in MM idle state towards the 3G_SGSN.

The illustrated transfer of MM signalling to/from the UE uses an established RRC connection. This RRC connection can have been established beforehand due to ongoing interwork between UE and 3G_MSC/VLR or be established only for this location registration procedure towards the 3G_SGSN.

For each indicated MM message sent in this case to/from UE, the CN discriminator indicates 3G_SGSN.

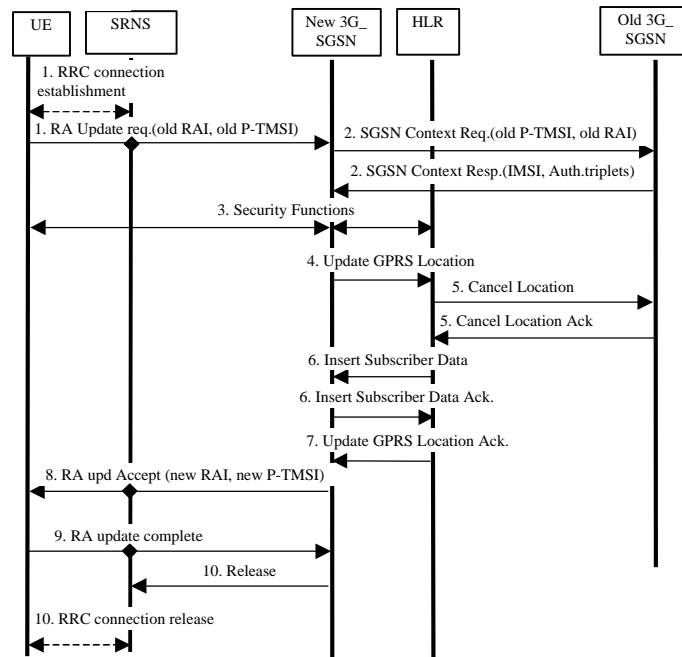

Figure 11 Interface information transfer for Routing Area update when changing SGSN area (successful case)

- 1) The RRC connection is established, if not already done. The UE sends the initial message Routing Area Update Request (old P-TMSI, old RAI, etc.) to the new 3G_SGSN. The old P-TMSI and the old RAI are assigned data in UMTS. The SRNS transfers the message to the 3G_SGSN. The sending of this message to 3G_SGSN will also imply establishment of a signalling connection between SRNS and 3G_SGSN for

the concerned UE. The 3G_SGSN determines the new Routing Area for the UE. Whether the 3G_SGSN derives the new RAI from information supplied by the UE or by the SRNS is ffs.

- 2) The new 3G_SGSN send an SGSN Context Request (old P-TMSI, old RAI) to the old 3G_SGSN to get the IMSI for the UE. (The old RAI received from UE is used to derive the old 3G_SGSN identity/address.) The old 3G_SGSN responds with SGSN Context Response (e.g. IMSI and Authentication triplets).
- 3) Security functions may be executed.
- 4) The new 3G_SGSN informs the HLR of the change of 3G_SGSN by sending Update GPRS Location (IMSI, SGSN number, SGSN address) to the HLR.
- 5) The HLR cancels the context in the old 3G_SGSN by sending Cancel Location (IMSI). The old 3G_SGSN removes the context and acknowledges with Cancel Location Ack.
- 6) The HLR sends Insert Subscriber Data (IMSI, subscription data) to the new 3G_SGSN. The new 3G_SGSN acknowledges with Insert Subscriber Data Ack.
- 7) The HLR acknowledges the Update GPRS Location by sending Update GPRS Location Ack. to the new 3G_SGSN.
- 8) The new 3G_SGSN validate the UEs presence in the new RA. If due to regional, national or international restrictions the UE is not allowed to attach in the RA or subscription checking fails, then the new 3G_SGSN rejects the Routing Area Update Request with an appropriate cause. If all checks are successful, then the new 3G_SGSN responds to the UE with Routing Area Update Accept (new P-TMSI, new RAI, etc.).
- 9) The UE acknowledges the new P-TMSI with Routing Area Update Complete.
- 10) When the location registration procedure is finished, the 3G_SGSN may release the signalling connection towards the SRNS for the concerned UE. The SRNS will then release the RRC connection if there is no signalling connection between 3G_MSC/VLR and SRNS for the UE.

7.3.11.1.3 Periodic Registration towards both CN nodes without use of Gs

This example shows Periodic Registration to both the 3G_MSC/VLR and the 3G-SGSN (i.e. no change of registration areas) when the UE is in MM idle state and registered in both the 3G_SGSN and the 3G_MSC/VLR.

The illustrated transfer of MM signalling to/from the UE uses an established RRC connection. This RRC connection will be established, is in this case, only for the two registration procedures towards the 3G_SGSN and 3G_MSC/VLR.

For each indicated MM message sent to/from UE, the CN discriminator indicates either 3G_SGSN or 3G_MSC/VLR.

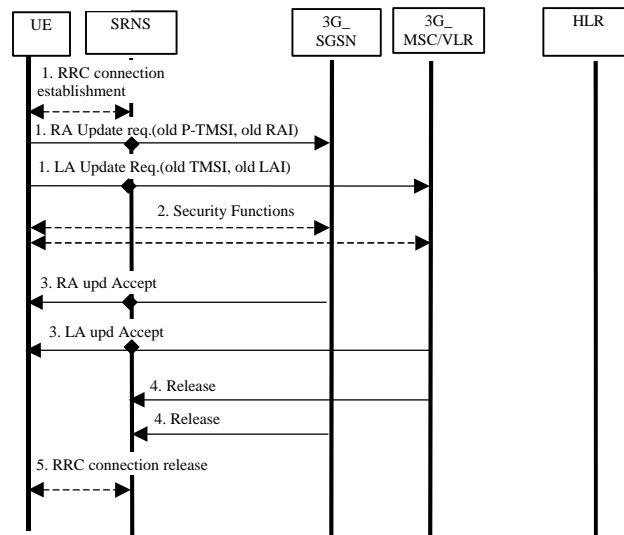

Figure 12 Interface information transfer for periodic registration to 3G_SGSN and 3G_MSC/VLR (successful case)

- 1) The RRC connection is established. The UE sends the initial messages Routing Area Update Request (old P-TMSI, old RAI, etc.) to the 3G_SGSN and Location Area Update Request (old TMSI, old LAI, etc.) to the 3G_MSC/VLR. In both cases, the UE will indicate the cause periodic registration. The sending of the respective message to SGSN respective to MSC/VLR will also imply establishment of a signalling connection between SRNS and SGSN and a signalling connection between SRNS and MSC/VLR for the concerned UE.
- 2) Security functions may be executed.
- 3) The 3G_SGSN respective the 3G_MSC/VLR validates the UEs presence. If all checks are successful, then the 3G_SGSN responds to the UE with Routing Area Update Accept and 3G_MSC/VLR responds to the UE with Location Area Update Accept.
- 4) When the periodic registration procedure is finished, the 3G_SGSN respective the 3G_MSC/VLR may release the signalling connection towards the SRNS for the concerned UE. If both CN nodes release the signalling connection towards the SRNS for the concerned UE, then the SRNS will release the RRC connection towards the UE.

7.3.11.1.4 Periodic Registration with use of Gs/UMSC

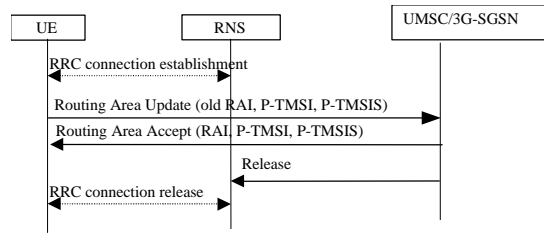

Figure 13: Periodic update procedure when the MS is attached for both CS and PS services

An RRC connection is established for the periodic registration. Note that this procedure is invoked only when the UE is in MM-idle state. The UE sends a Routing Area Update to the UMSC. The UMSC authenticates the P-TMSI signature. If the update is successful it sends a Routing Area Accept message. The RRC connection is then released.

7.3.11.1.5 UE initiated Combined Detach Procedure when using Gs/UMSC

The UE-Initiated Detach procedure when initiated by the UE is illustrated in Figure 30. Each step is explained in the following list.

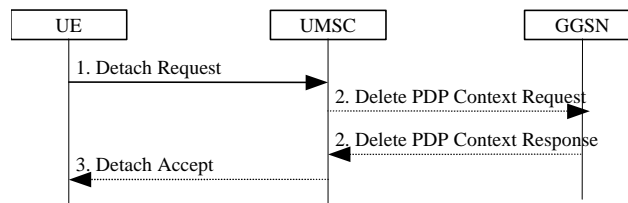

Figure 29: UE-Initiated Combined Detach Procedure (The procedure for combined detach when using Gs is as defined in GSM 03.60)

- 1) The UE detaches by sending Detach Request (Detach Type, Switch Off) to the UMSC. Detach Type indicates which type of detach that is to be performed, i.e., PS Detach only, CS Detach only or combined Detach. Switch Off indicates whether the detach is due to a switch off situation or not.
- 2) If PS detach, any active PDP contexts in the GGSNs regarding this particular UE may be deactivated. This is FFS
- 3) If Switch Off indicates that the detach is not due to a switch off situation, the UMSC sends a Detach Accept to the UE.

7.3.11.2 SRNS Relocation

The signalling procedures shown in the following sections do not represent the complete set of possibilities, nor do they mandate this kind of operation. The standard will specify a set of elementary procedures for each interface, which may be combined in different ways in an implementation. Therefore these sequences are merely examples of a typical implementation. In these examples MSC stands for 3G_MSC/VLR and SGSN stands for 3G_SGSN.

Furthermore the list of parameters may not be complete, but should only be seen as examples of possible information carried by the messages.

7.3.11.2.1 SRNS relocation (UE connected to a single CN node, 3G_MSC/VLR) followed by Location Registration in new Routing Area

This example shows SRNS relocation when source RNC and target RNC are connected to different 3G_MSC/VLR. This is then followed by a Routing Area update procedure towards a new SGSN. Figure 14 and Figure 15 illustrate the situation before respective after the SRNS relocation and location registration. Figure 16 illustrates the signalling sequence where each step is explained in the following list.

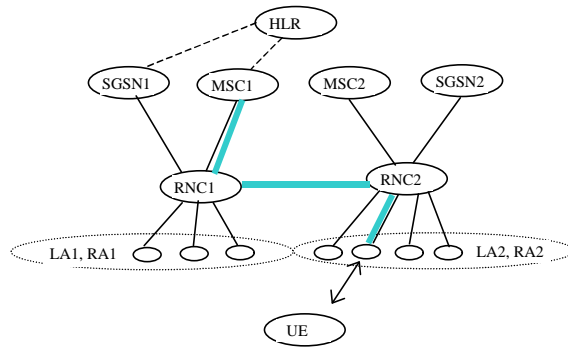

Figure 14 Before the SRNS relocation and location registration

Before the SRNS relocation and location registration the UE is registered in SGSN1 and in MSC1. The UE is in state MM idle towards the SGSN1 and in state MM connected towards the MSC1. The RNC1 is acting as SRNC and the RNC2 is acting as DRNC.

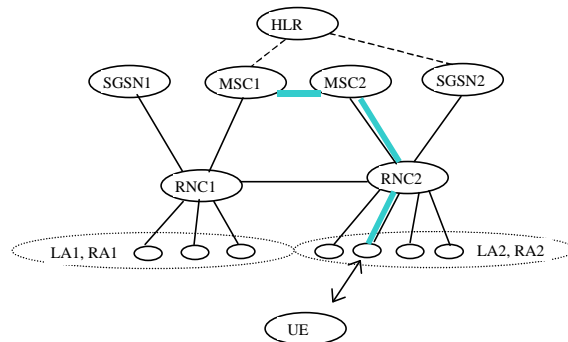

Figure 15 After the SRNS relocation and location registration

After the SRNS relocation and location registration the UE is still registered in MSC1 while the registration in the IP domain has changed from SGSN1 to SGSN2. The UE is in state MM idle towards the SGSN2 and in state MM connected towards the MSC1. The RNC2 is acting as SRNC.

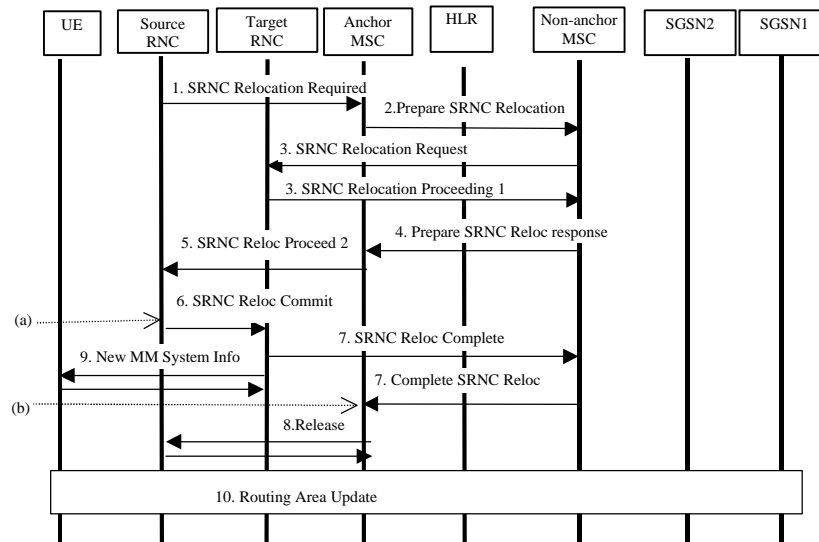

Figure 16 Interface information transfer for SRNS relocation when UE connected to 3G_MSC/VLR followed by location registration in new Routing Area.

- 1) UTRAN makes the decision to perform the Serving RNC relocation procedure. This includes decision on into which RNC (Target RNC) the Serving RNC functionality is to be relocated. The source SRNC sends SRNC Relocation required messages to the MSC. This message includes parameters such as target RNC identifier and an information field that shall be passed transparently to the target RNC.
- 2) Upon reception of SRNC Relocation required message the Anchor MSC (MSC1) prepares itself for the switch and determines from the received information that the SRNC relocation will (in this case) involve another MSC. The Anchor MSC will then send a Prepare SRNC Relocation Request to the applicable non-anchor MSC (MSC2) including the information received from the Source RNC.
- 3) The non-anchor MSC will send a SRNC Relocation Request message to the target RNC. This message includes information for building up the SRNC context, transparently sent from Source RNC (UE id., no of connected CN nodes, UE capability information), and directives for setting up Iu user plane transport bearers. When Iu user plane transport bearers have been established, and target RNC has completed its preparation phase, SRNC Relocation Proceeding 1 message is sent to the non-anchor MSC.
- 4) The Prepare SRNC Relocation Response that is sent from non-anchor MSC to Anchor MSC will contain the SRNC Relocation Proceeding 1 received from target RNC.
- 5) When the SRNC Relocation Proceeding 1 has been received in the Anchor MSC, the user plane transport bearers has been allocated the whole path between target RNC and Anchor MSC and the Anchor MSC is ready for the SRNC move, then the Anchor MSC indicates the completion of preparation phase at the CN side for the SRNC relocation by sending the SRNC relocation proceeding 2 message to the Source RNC.
- 6) When the source RNC has received the SRNC Relocation Proceeding 2 message, the source RNC sends a SRNC Relocation Commit message to the target RNC. The target RNC executes switch for all bearers at the earliest suitable time instance.
- 7) Immediately after a successful switch at RNC, target RNC (=SRNC) sends SRNC Relocation Complete message to the non-anchor MSC. This message is included by the non-anchor MSC in the Complete SRNC relocation message that is sent to the anchor MSC. Upon reception of this message, the Anchor-MSC switches from the old Iu transport bearers to the new ones.

- 8) After a successful switch at the Anchor MSC, a release indication is sent towards the Source RNC. This will imply release of all UTRAN resources that were related to this UE.
- 9) When the target RNC is acting as SRNC, it will send New MM System Information to the UE indicating e.g. relevant Routing Area and Location Area. Additional RRC information may then also be sent to the UE, e.g. new RNTI identity.
- 10) When receiving new MM system information indicating a new Routing Area, the UE will in this case initiate a Routing Area update procedure towards the SGSN.

Before point (a), in Figure 16, the connection is established between UE and Anchor MSC via Source RNC.

After point (b), in Figure 16, the connection is established between UE and Anchor MSC via Target RNC and Non-anchor MSC.

7.3.11.2.2 SRNS relocation (UE connected to a single CN node, 3G_SGSN) followed by Location Registration in new Location Area

This example shows SRNS relocation when source RNC and target RNC are connected to different 3G_SGSN. Figure 17 and Figure 18 illustrate the situation before respective after the SRNS relocation and location registration. Figure 19 illustrates the signalling sequence where each step is explained in the following list.

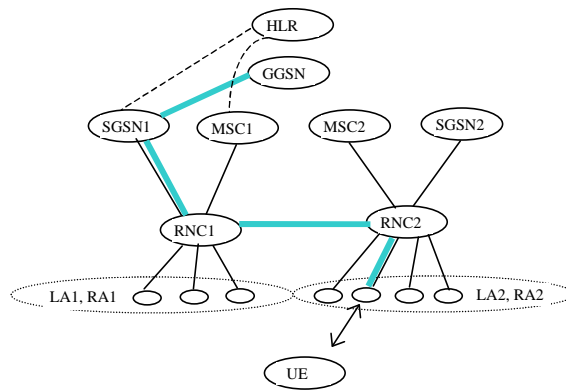

Figure 17 Before the SRNS relocation and location registration

Before the SRNS relocation and location registration the UE is registered in SGSN1 and in MSC1. The UE is in state MM connected towards the SGSN1 and in state MM idle towards the MSC1. The RNC1 is acting as SRNC and the RNC2 is acting as DRNC.

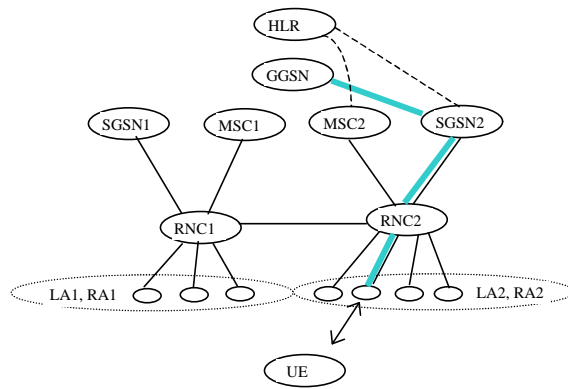

Figure 18 After the SRNS relocation and location registration

After the SRNS relocation and location registration the UE is registered in MSC2 and in SGSN2. The UE is in state MM connected towards the SGSN2 and in state MM idle towards the MSC2. The RNC2 is acting as SRNC.

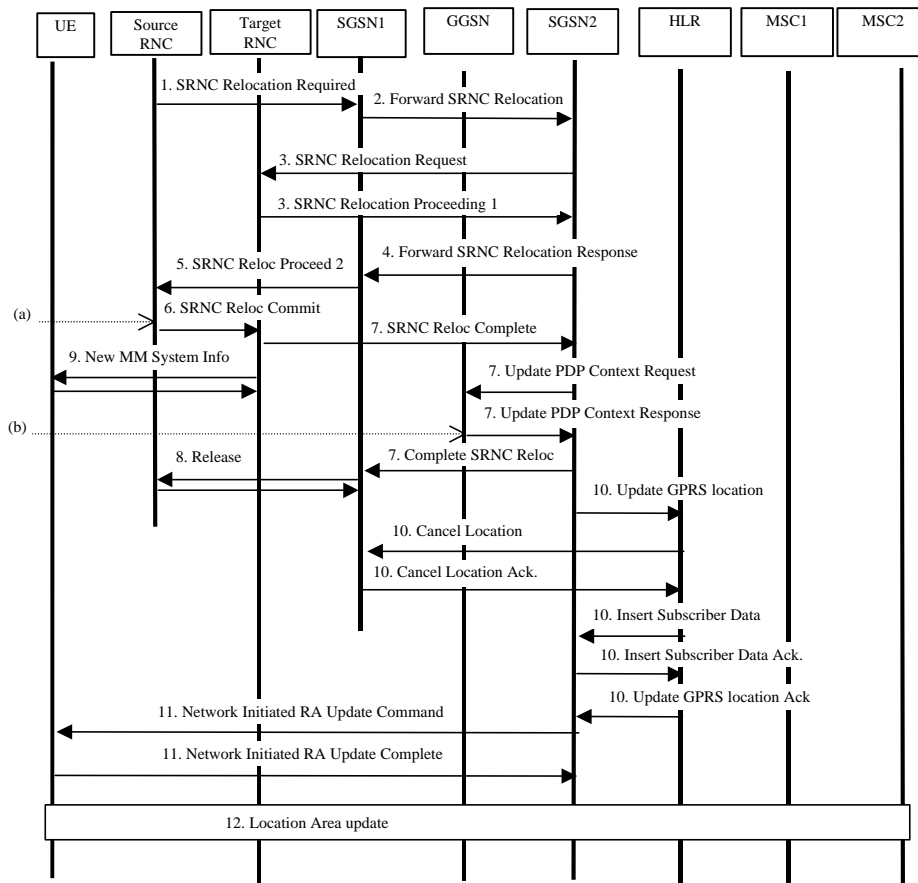

Figure 19 Interface information transfer for SRNS relocation update when changing SGSN area resulting in a change of registered location and followed by location registration in new Location Area.

- 1) UTRAN makes the decision to perform the Serving RNC relocation procedure. This includes decision on into which RNC (Target RNC) the Serving RNC functionality is to be relocated. The source SRNC sends SRNC Relocation required messages to the SGSN1. This message includes parameters such as target RNC identifier and an information field that shall be passed transparently to the target RNC.
- 2) Upon reception of SRNC Relocation required message the SGSN1 determines from the received information that the SRNC relocation will (in this case) result in change of SGSN. The SGSN will then send a Forward SRNC relocation request to the applicable SGSN, SGSN2, including the information received from the Source RNC and necessary information for the change of SGSN (e.g. MM context, PDP context).
- 3) The SGSN2 will send a SRNC Relocation Request message to the target RNC. This message includes information for building up the SRNC context, transparently sent from Source RNC (e.g. UE id., no of connected CN nodes, UE capability information), and directives for setting up Iu user plane transport bearers. When the Iu user plane transport bearers have been established, and target RNC completed its preparation phase, SRNC Relocation Proceeding 1 message is sent to the SGSN2.

- 4) When the traffic resources between target RNC and SGSN2 has been allocated and the SGSN2 is ready for the SRNC move, then the Forward SRNC Relocation Response is sent from SGSN2 to SGSN1. This message indicates that necessary resources have been allocated for the SRNC relocation.
- 5) When the Forward SRNC Relocation Response has been received in the SGSN1, the SGSN1 indicates the completion of preparation phase at the CN side for the SRNC relocation by sending the SRNC Relocation Proceeding 2 message to the Source RNC.
- 6) When the source RNC has received the SRNC Relocation Proceeding 2 message, the source RNC sends a SRNC Relocation Commit message to the target RNC. The target RNC executes switch for all bearers at the earliest suitable time instance.
- 7) Immediately after a successful switch at RNC, target RNC (=SRNC) sends SRNC Relocation Complete message to the SGSN2. Upon reception of this message, the SGSN2 updates the GGSN with a Update PDP Context Request including the new SGSN address. The GGSN will then update the PDP context and return Update PDP Context Response. The SGSN will also send a Complete SRNC Relocation towards the SGSN1.
- 8) At reception of the Complete SRNC Relocation, SGSN1 will send a release indication towards the Source RNC. This will imply release of all UTRAN resources that were related to this UE.
- 9) When the target RNC is acting as SRNC, it will send New MM System Information to the UE indicating e.g. relevant Routing Area and Location Area. Additional RRC information may then also be sent to the UE, e.g. new RNTI identity.
- 10) The SGSN2 informs the HLR of the change of SGSN by sending Update GPRS location (IMSI, new SGSN address etc.) to the HLR. The HLR cancels the context in the old SGSN, SGSN1, by sending Cancel Location (IMSI). The SGSN1 removes the context and acknowledges with Cancel Location Ack. The HLR sends Insert subscriber data (IMSI, subscription data) to the SGSN2. The SGSN2 acknowledges with Insert Subscriber Data Ack. The HLR acknowledges the Update GPRS location by sending Update GPRS Location Ack to the SGSN2.
- 11) At reception of Insert subscriber data from HLR, the SGSN2 will initiate the update of MM information stored in the UE. This is done by sending Network Initiated Routing Area Update Command to the UE. This message will include new RAI, and possible also new P-TMSI. When the UE has made necessary updates it answers with Network Initiated Routing Area Update Complete.
- 12) When receiving new MM system information indicating a new Location Area, the UE will, in this case, initiate a Location Area update procedure towards the MSC2. This implies that the Location Area update will be performed in parallel to the above indicated activities related to the SGSN side of the Core Network.

Before point (a), in Figure 19, the connection is established between UE and GGSN via Source RNC and SGSN1.

After point (b), in Figure 19, the connection is established between UE and GGSN via Target RNC and SGSN2.

7.3.11.3 Comparison between UMTS and GSM

For the PSTN/ISDN domain, the proposed UMTS MM concept is in principle identical to the GSM MM.

For the IP domain, the differences between the proposed UMTS MM concept and the GSM GMM are more extensive, such as:

- a) "Cell update" is moved from GMM level in GSM to RRC level in UMTS.
- b) "Routing area update" in GSM GMM-standby state is moved from GMM level in GSM to RRC level in UMTS and corresponds to "URA update".
- c) A new case when "Routing area update" is performed towards 3G_SGSN is introduced in the UMTS PS-IDLE state.
- d) A UMTS PS-CONNECTED state is introduced and in this state the UE mobility towards the CN will be handled by UTRAN-CN procedures, i.e. not on MM level.

Figure 25 provides illustration of the above bullets.

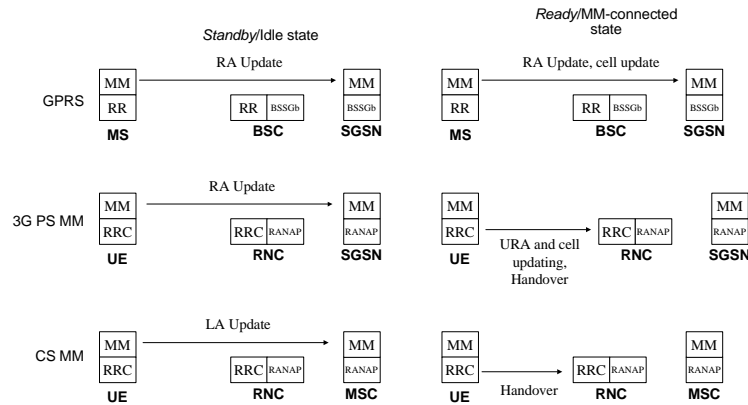

Figure 20 The states written in italics correspond to those defined in GSM with GPRS.

7.3.11.3.1 PS -idle state

The RA update procedure is utilised to update the whereabouts of the UE into SGSN. The updating into SGSN takes place irrespectively of the CS MM state in MSC.

7.3.11.3.2 PS -connected state

The URA and cell updating and handover procedures presented in Figure 25 are based on UMTS YY.03 [2]. In brief, the aim in [2] is to introduce functionality that caters for the same functionality as standby/ready in GPRS. The RRC shall be designed in such a fashion, which allows the state of the RRC connection to define the level of activity associated to a packet data connection. The key parameters of each state are the required activity and resources within the state and the required signalling prior to the packet transmission. The similar functionality in GPRS is offered via standby/ready at MM level.

The cell update and URA update between UE and RNC are used when the UE is in RRC common channel state, i.e., when the above mentioned parameters allow to scale down the resources reserved for the UE (for a more detailed description on this, see [2]). For example, the purpose of the cell update procedure is to allow the UE to inform its current location in the corresponding RRC state. According to [2] the cell update procedure replaces handover in the corresponding RRC substate.

To summarise, the RRC procedures proposed by [2] allow the CN MM to be independent of the actual activity. This is a significant deviation from GPRS MM, which is closely related to the activity in terms of implementing standby and ready functionality at MM level. Another significant deviation from GPRS is the introduction of the handover procedures for connections supporting traffic into IP domain (in RRC cell connected state, see [2]).

7.3.11.4 Issues for further study

List of issues that are for further study related to this chapter and is the following:

- a) More details are required with regards to the differences with regards to the "IP-domain" MM compared to GPRS MM, especially considering roaming and handover to/from UMTS to GSM/GPRS.
- b) More details should be provided with regards to the logical relations between UE-CN and UTRAN-CN, and how these relate to the physical interconnection between UTRAN and the CN nodes(s), namely whether one logical/physical Iu can be used to interconnect the UTRAN with the CN.

- c) It should be clarified whether this approach allows for the possibility to use a common signalling connection from MSC and/or SGSN to the HLR.

7.3.12 Combined update towards the HLR for a combined 3G-(MSC/VLR+SGSN) configuration

7.3.12.1 Motivation

In order to optimise the signalling load within the network, reduce operating and maintenance costs and creating the possibility to combine cs and ps handover it is essential to open the door in the specifications for combined 3G-(MSC/VLR+SGSN) solutions.

7.3.12.2 Technical description

For the area concept discussed for the time being, four different cases have to be distinguished:

1. change of UTRAN Registration Area (URA) within the same Routing Area (RA)
2. change of URA and RA within the same Location Area (LA)
3. change of URA, RA, or LA within the same node
4. change of URA, RA, or LA, and node

For a combined 3G-(MSC/VLR+SGSN) node only in case 4 the UE's HLR has to be updated. If the UE is idle mode for the packet and circuit switched traffic a combined 3G-(MSC/VLR+SGSN) node will run the location update procedure jointly for the UE's cs and ps domain resulting in one combined location update message, see Figure 3.

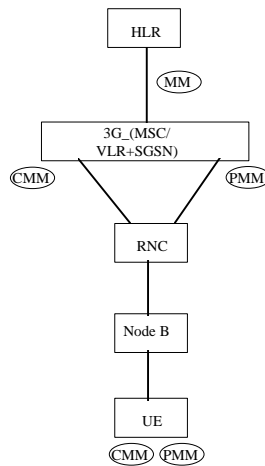

Figure 21 Combined MM Instance For a Combined 3G-(MSC/VLR+SGSN) Node

Split nodes may have to run one specific location update procedure for any of the two domains resulting in two separate location update messages, see Figure 4.

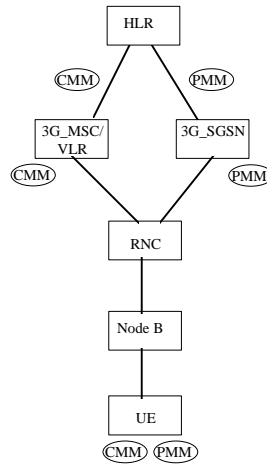

Figure 22 Split MM Instances for Separate Nodes

7.3.12.3 Requirements on UTRAN

The provision of location information by the UE to the core network must be independently of whether the 3G-MSC/VLR and 3G-SGSN are implemented as separate entities or as a combined node. It shall be possible to use a combined update procedure between serving node and HLR irrespective of the update procedure used between the UE and the serving node.

7.3.12.4 List of MAP services for location management between the HLR and MSC-VLR/SGSN for GSM/GPRS

Table 1 shows the MAP services used for location management between the SGSN and MSC/VLR and the HLR as defined in GSM/GPRS release 98.

MAP service	Comment
MAP_UPDATE_LOCATION service	Updates VLR and MSC number in the HLR
MAP_UPDATE_GPRS_LOCATION service	Updates SGSN number and address in the HLR
MAP-INSERT-SUBSCRIBER-DATA service	Inserts subscriber data for GSM or GPRS
MAP_SEND_AUTHENTICATION_INFO service	To send authentication triplets to VLR or SGSN
MAP_CANCEL_LOCATION service	Cancels location in VLR or SGSN
MAP_PURGE_MS service	Marks user as unreachable in HLR. Common service for both GSM and GPRS

Table 1: List of Location management services between the HLR and MSC/VLR and SGSN

From the above table, it is clear that only minor modifications are required to MAP services between the MSC/VLR and SGSN and the HLR. A new service combining the MAP_UPDATE_LOCATION and MAP_UPDATE_GPRS_LOCATION services will need to be defined. All other services are common for both GSM and GPRS and can be used with minor modifications in the “conditional” parameter list.

7.3.12.5 Signalling procedures for combined update towards HLR

7.3.12.5.1 Combined attach case where the previous attach was towards 2 CN elements

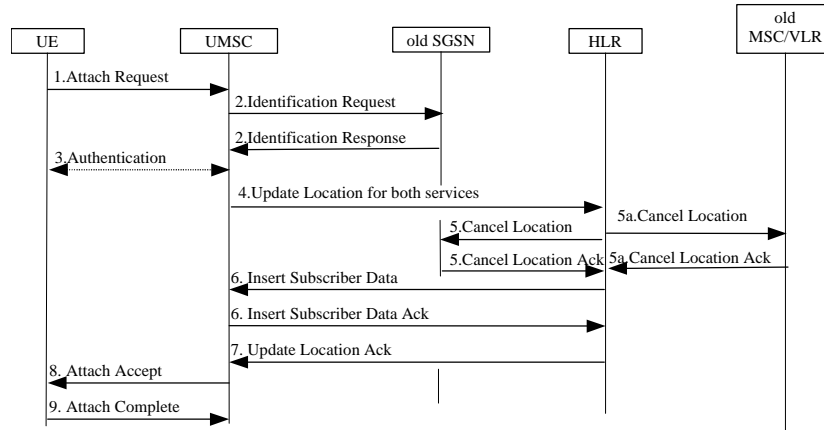

Figure 23 Combined attach procedure when the Ms moves from 2 CN element to a UMSC

- 1) The UE initiates the attach procedure by the transmission of an Attach Request (IMSI or P-TMSI and old RAI, Attach Type, old P-TMSI Signature) message to the UMSC. Attach Type indicates which type of attach that is to be performed, i.e., PS attach only, CS attach only, or combined attach (the example given is for combined attach).
- 2) If the UE identifies itself with P-TMSI and the 3G-SGSN/UMSC has changed since detach, the new UMSC sends an Identification Request (P-TMSI, old RAI, old P-TMSI Signature) to the old SGSN to request the IMSI. The old SGSN responds with Identification Response (IMSI, Authentication Triplets). If the UE is not known in the old SGSN, the old SGSN responds with an appropriate error cause. The old SGSN also validates the old P-TMSI Signature and responds with an appropriate error cause if it does not match the value stored in the old SGSN.
- 3) The authentication functions are optional and may be used for example if P-TMSI signature authentication was not successful. If the UMSC number has changed since the detach, or if it is the very first attach, routing/location area update procedures are executed:
- 4) The UMSC sends a Combined Update Location (UMSC Number, UMSC Address, IMSI) to the HLR.
- 5) The HLR sends Cancel Location (IMSI, Cancellation Type) to the old SGSN and MSC. The old SGSN and MSC acknowledges with Cancel Location Ack (IMSI).
- 6) The HLR sends Insert Subscriber Data (IMSI, PS and CS subscription data) to the new UMSC. The new UMSC validates the UE's presence in the (new) RA. If all checks are successful then the UMSC constructs an MM context for the UE and returns an Insert Subscriber Data Ack (IMSI) message to the HLR.

- 7) The HLR acknowledges the Update Location message by sending an Update Location Ack to the UMSC. If the Update Location is rejected by the HLR, the UMSC rejects the Attach Request from the UE with an appropriate cause.
- 8) The UMSC sends an Attach Accept (P-TMSI, TMSI, P-TMSI Signature) to the UE.
- 9) If P-TMSI or TMSI was changed, the UE acknowledges the received TMSI(s) with Attach Complete (P-TMSI, TMSI).

If the Attach Request cannot be accepted, the UMSC returns an Attach Reject (IMSI, Cause) message to the UE.

7.3.12.5.2 Combined location/routing area update where the previous LA/RA belonged to a 2 CN element

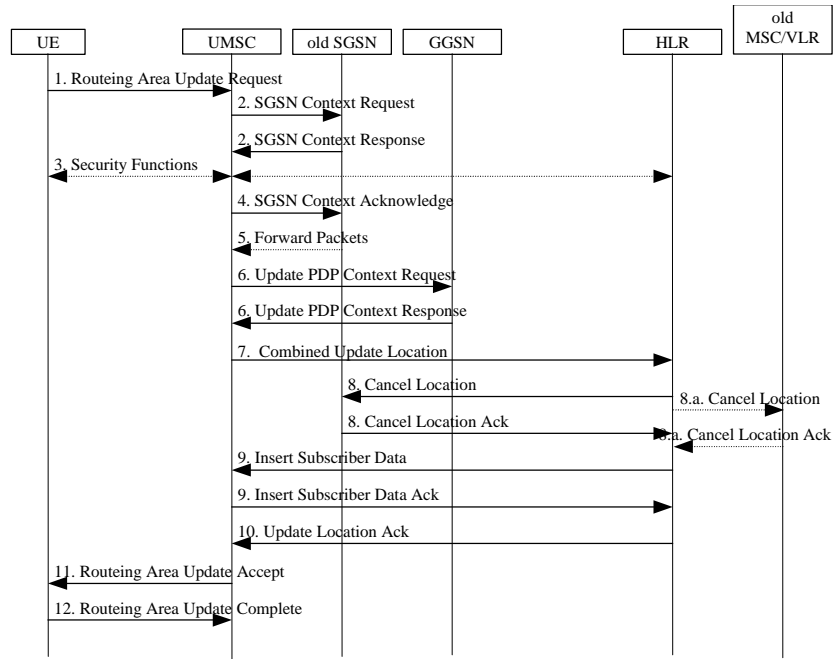

Figure 24 Combined LA/RA update when the MS moves from 2 CN element to UMSC

- 1) The UE sends a Routing Area Update Request (old RAI, old P-TMSI Signature, Update Type) to the new UMSC. Update Type example given here is for combined RA / LA update.
- 2) The new UMSC sends SGSN Context Request (old RAI, P-TMSI, old P-TMSI Signature, New UMSC Address) to the old SGSN to get the MM and PDP contexts for the UE. The old SGSN validates the old P-TMSI Signature and responds with an appropriate error cause if it does not match the value stored in the old SGSN. This should initiate the security functions in the new UMSC.
- 3) Security functions may be executed. These procedures are defined in subclause "Security Function".
- 4) If the user has at least one activated PDP context, then the new UMSC shall send an SGSN Context Acknowledge message to the old SGSN. This informs the old SGSN that the new UMSC is ready to receive data packets belonging to the activated PDP contexts.

- 5) The old SGSN starts tunnelling of buffered N-PDUs to the new UMSC. However, the possibility of this happening is remote since the UE is in MM-idle indicating that it was not in active communication.
- 6) The new UMSC sends Update PDP Context Request to the GGSNs concerned. The GGSNs update their PDP context fields and return an Update PDP Context Response (TID).
- 7) The new UMSC informs the HLR of the change of SGSN/MSR by sending Combined Update Location (UMSC Number, UMSC Address, IMSI) to the HLR.
- 8) The HLR sends Cancel Location (IMSI, Cancellation Type) to the old SGSN and MSR. The old SGSN acknowledges with Cancel Location Ack (IMSI).
- 9) The HLR sends Insert Subscriber Data (IMSI, PS and CS subscription data) to the new UMSC. The new UMSC validates the UE's presence in the (new) RA. If due to regional subscription the UE is rejected, the UMSC rejects the Attach Request with an appropriate cause and returns an Insert Subscriber Data Ack (IMSI, UMSC Area Restricted Due To Regional Subscription) message to the HLR. If all checks are successful then the UMSC constructs an MM context for the UE and returns an Insert Subscriber Data Ack (IMSI) message to the HLR.
- 10) The HLR acknowledges the Update Location by sending Update Location Ack (IMSI) to the new UMSC.
- 11) The new UMSC validates the UE's presence in the new RA. If due to regional, national or international restrictions the UE is not allowed to attach in the RA or subscription checking fails, then the UMSC rejects the routing area update with an appropriate cause. If all checks are successful then the new UMSC establishes MM and PDP contexts for the UE. The new UMSC responds to the UE with Routing Area Update Accept (P-TMSI, TMSI, P-TMSI Signature).
- 12) The UE confirms the reallocation of the TMSIs by sending Routing Area Update Complete to the UMSC.

7.4. UMTS call control

7.4.1 Technical Requirements

The following technical requirements are applied to support multimedia in GSM/UMTS.

- P1) GSM/UMTS shall enable the provisioning of multimedia services and with multivendor interworking between UE and network.
- P2) Basic voice and PDP-context establishment shall be based on GSM CC/SM respectively.
- P3) Handover and roaming to and from GSM shall be supported provided GSM is capable of supporting the ongoing media service.
- P4) Ideas, concepts and procedures developed by other fora e.g. other standards bodies such as ITU, IETF etc. shall be included or referenced in the GSM/UMTS CC/SM when found suitable.
- P5) The following major alternatives or a combination there-of are identified
 - P5a) Enhance GSM Call Control and Session Management by specifying GSM/UMTS specific procedures or using elements from H.323 or other standards.
 - P5b) For multimedia services a new CC/SM protocol could be introduced as a peer to GSM/GPRS CC/SM - possibly by reference to other standards (eg H.323).
 - P5c) For multimedia services a multimedia CC/SM protocol could be run transparently via a PDP-context established using GSM SM which would allow transparent handover and roaming between GSM and UMTS provided that GSM supports the QoS requirements.

7.5 Core network layer 3

In UMTS/GPRS, it should be possible for operators to use different packet switching protocol (e.g. ATM-SVC) under single GTP standard.

Between GSNs GTP uses UDP/IP (or TCP/IP) for addressing regardless whether IP routing or ATM-SVC switching is used. The use of ATM-SVC will not impact on GTP standardisation.

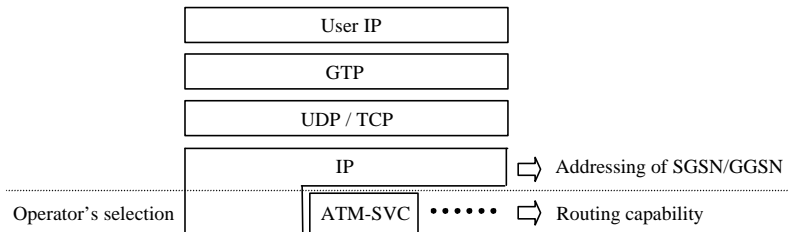

7.6 Alternate Access technologies to UTRAN

BRAN Access

The evolved GPRS network should allow for various radio access networks. As stated in [UMTS 23.01], a modular approach in UMTS evolution is recommended. This is also in line with the recommendation from GMM. Thus, the infrastructure domain, which encompasses the core network domain and the access network domain, allows for different access techniques/networks to be used. This scenario focuses on EP BRAN HIPERLAN 2 as a complement to GSM BSS and UTRAN in order to provide broadband data services in hot spot environments.

ETSI Project BRAN (Broadband Radio Access Networks) is developing specifications for broadband wireless access systems that support data rates around 25 Mbit/s for several applications. The primary focus for HIPERLAN 2 is to provide short range wireless broadband access with controlled quality of service for use within buildings and on-campus using unlicensed radio spectrum in the 5 GHz band. HIPERLAN 2 shall provide a range of 30-50 m in a typical indoor environment and up to 150-200 m in a typical outdoor environment.

The HIPERLAN 2 specifications are expected to be finalised during 2000, hence it will be possible to introduce BRAN access in UMTS phase 1.

7.6.1 Advantages of attaching HIPERLAN 2 to UMTS

- Provide UMTS with a complementary access technology for broadband data services for indoor and hot spots environments
- UMTS mobility infrastructure enables roaming also for HIPERLAN 2 terminals
- Easier multi-mode UMTS/HIPERLAN 2 service integration, enables e.g. network support for a one number service and the use of a common service platform
- UMTS subscriber management may be reused for HIPERLAN 2
- Enables the reuse of investments in core network technologies.

7.6.2 HIPERLAN 2 UMTS Interworking

UMTS will incorporate a new generic radio access network, the UMTS Radio Access Network (URAN). The URAN may include several different realisations, of which the UTRAN (UMTS Terrestrial Radio Access Network) is one. The Iu reference point forms the boundary between URAN and the UMTS core network. By connecting HIPERLAN 2 to the Iu interface, HIPERLAN 2 will form a complimentary realisation of the URAN concept for broadband data services. UMTS interworking will provide HIPERLAN 2 with roaming support using the UMTS mobility infrastructure.

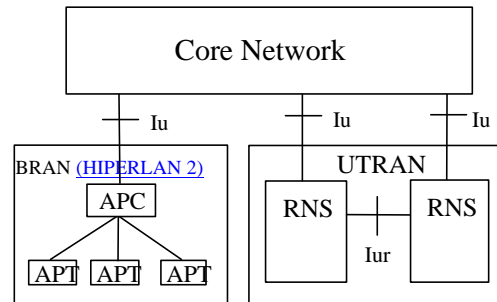

Figure 25: HIPERLAN 2 UMTS interworking.

A HIPERLAN 2 realisation of URAN should provide the same logical interface to the higher layers (i.e. layers belonging to the non-access stratum) as UTRAN. Hence, no changes in higher layers should be required. UMTS authentication, security and location management can be used over HIPERLAN 2. UMTS bearer setup requests should be mapped to the corresponding HIPERLAN 2 DLC connection. A USIM (User Service Identity Module) may be needed in a BRAN terminal supporting UMTS interworking. Handovers within a HIPERLAN 2 subsystem should be invisible to the core network. Handovers between UTRAN and HIPERLAN 2, in case of dual mode terminals, should be supported via the core network.

7.6.3 Related Actions

The same protocols over the Iu interface should be used for both UTRAN and HIPERLAN 2. However, some impact of connecting a broadband access network, capable of bit rates in the order of 100 Mbit/s, can be expected. Therefore the Iu must be flexible and future proof. Guidance and co-operation with EP BRAN on these matters should be sought.

8. 0 UMTS Concepts

Section 8 contains concepts that are considered as stable within SMG12 and no further input is expected but it should also be noted that consensus could not be reached on their use within UMTS.

8.1 Reduction of UMTS signalling

8.1.1 GLR Concept

The benefits of the Gateway Location Register (GLR) are:

- reduction in signalling traffic between networks.
- potential enhancements to mobile terminated call handling

8.1.1.1 Overview of the GLR Concept

The GLR is a node between the VLR and the HLR, which may be used to optimise the handling of subscriber location data across network boundaries.

In Figure 26, the GLR interacts with HLRA and VLRb for roamers on Network B. The GLR is part of the roaming subscriber's Home Environment. When a subscriber to HLRA is roaming on Network B the GLR plays the role of an HLR towards VLRb and the role of a VLR towards HLRA. The GLR handles any location change between different VLR service areas in the visited network without involving HLRA.

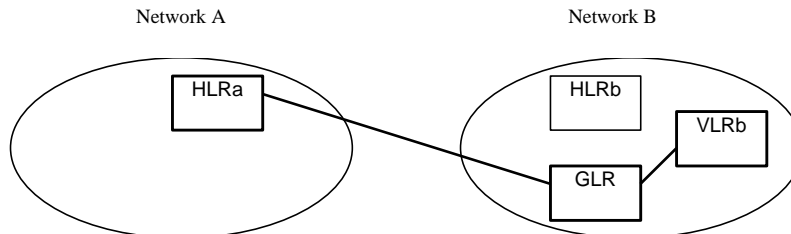

Figure 26 GLR Overview

The sequence of events when the subscriber roams to network B is as follows:

- VLRb sends the registration message to HLRA via the GLR, (i.e. HLRA stores the GLR's SCCP address and the GLR stores VLRb's SCCP address).
- HLRA returns the subscriber profile data
- The subscriber profile is stored in the GLR and VLRb

As the roaming subscriber moves between VLRs in network B, then the GLR is updated, but no message is sent to HLRA, therefore the number of messages between Network A and Network B is reduced. The reduction in signalling traffic is a significant benefit when the two networks are far apart, e.g. between Europe and Japan.

8.1.1.2 Applications of the GLR

In addition to reducing the amount of mobility related signalling between networks, the GLR's function might also be extended to other aspects. These include the following:

- Enhancements for mobile terminated call handling
- Support for the Virtual Home Environment of a roaming subscriber
- Reduction of CAMEL signalling traffic between the visited and home network
- Hiding local variations in signalling between networks
- Further study is needed on these issues

8.1.2. Super-Charger

The signalling load associated with subscriber roaming can be high when either the MSC/VLR areas are small or the subscriber travels significantly. The Super-Charger concept aims to optimise signalling associated with subscriber data management by retaining subscription data in previously visited VLRs, where possible.

The benefits of the Super-Charger concept are:

- Reduction of signalling traffic for subscribers located in the home PLMN,
- Reduction of signalling traffic between the visited PLMN and the home PLMN,
- No new network nodes are required,
- Applicable to a wide range of protocol used for the transfer of data.

8.1.2.1 Overview of the Super-Charger Concept

The concept of the Super-Charged network is described with examples from GSM mobility management. However, Super-Charger can be applied to other scenarios and protocols. This is a further study.

Super-Charger retains subscriber data stored in VLRs after the subscriber has moved to a location area served by a different VLR. The HLR performs the insertion of subscriber data to the VLR serving the location area to which the subscriber has roamed. The subscriber data stored at previously visited VLRs shall not be maintained while the subscriber is located in a location area serviced by a different VLR.

When the subscriber moves to a location area served by a VLR that has retained the subscriber's subscription data, the VLR shall indicate to the HLR whether subscriber data is required. If the VLR indicates that subscription data is not required but the user's subscription data has changed the HLR shall send the new subscription data to the VLR. Figure x shows an example message flow in a Super-Charged network.

To ensure data consistency for super-charged VLRs a sequence numbering method can be used. A sequence number is added to the subscriber data record. This sequence number is incremented whenever the subscriber data record is changed for any reason. The sequence number is sent to the VLR in ISD. For non-super-charged VLRs this can be ignored. For super-charged VLRs it is stored and returned to the HLR in subsequent UpdateLocation messages. The HLR can then compare this sequence number with the value currently stored in the HLR to determine if the cached data is still valid.

With the Super-Charger activated subscriber information is no longer deleted from the VLR database when a mobile station moves from the location area served by the VLR. This results in the continuous growth of the VLR database size. Consequently, a new VLR data management system is required so that the VLR can handle newly arrived mobile stations. Two options for subscriber data management systems are:

- subscriber data for subscribers that are not currently served by the VLR shall be deleted periodically using a VLR audit system and/or,
- subscriber data for subscribers that are not currently served by the VLR shall be deleted dynamically to make room for the newly arrived subscribers.

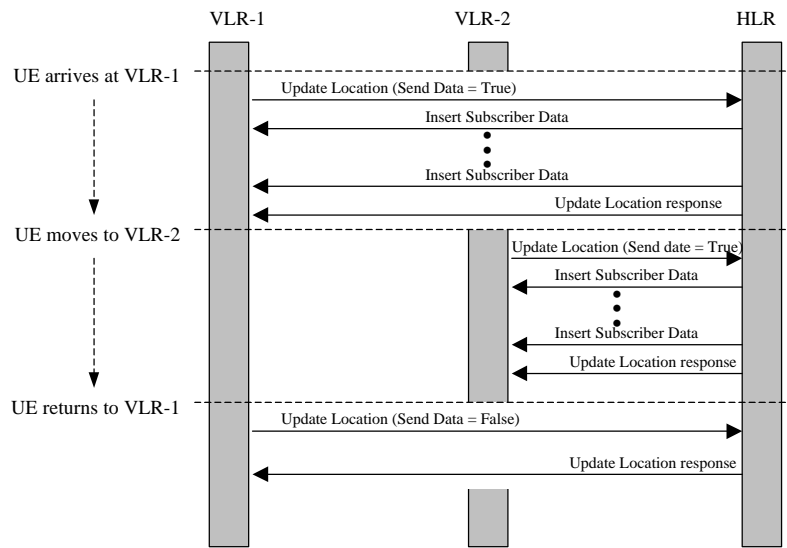

Figure 27: Example message flow in a Super-Charged network.

9 Key issues

{Editors note: These key issues have arisen from the scenario work, it is agreed within SMG12 that the focus should be on solving these key issues. Once these issues have become relatively stable, they are moved to the Section 7 or 8 or removed from this document}. Study of these items is ongoing.

9.1 Core network transport

- L1 and L2 technologies
- Signalling protocols
- How to use ATM?
- Nx64k transport

9.2 Core network layer 3

- L3 technologies
- GTP vs. IP-in-IP tunneling

In UMTS/GPRS, it should be possible for operators to use different packet switching protocol (e.g. ATM-SVC) under single GTP standard.

Between GSNs GTP uses UDP/IP (or TCP/IP) for addressing regardless whether IP routing or ATM-SVC switching is used. The use of ATM-SVC will not impact on GTP standardisation

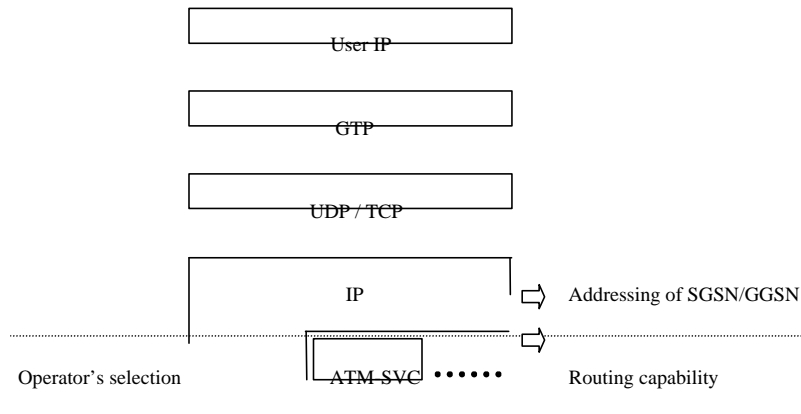

9.3 Benefits of the Gs interface applied to UMTS

The Gs interface defined within GSM/GPRS provides a number of benefits to a GSM/GPRS operator [03.60]. These include: combined attach/detach procedures, combined location/routing area updates, paging of CS connection via the SGSN, identification procedures, MM information procedures. The main aims of these include saving of GSM/GPRS radio resources, harmonised security procedures and reduction of MS battery consumption.

As GSM operators roll out GPRS and as the numbers of mobiles increase the benefits of the Gs interface to the network operator will increase as the percentage of GPRS enabled mobiles grows. GSM/GPRS operators with mature

networks will also be looking to roll out UMTS using evolved CN infrastructure, they will also be looking to apply the benefits of the Gs interface reaped for GSM to UMTS. Many of the capabilities of the Gs interface will be applicable to UMTS (such as combined updates, combined attach and MS/UE information procedures), this will save on radio resource usage. The presence of the MSC-GSN interface will also offer the opportunity for developments to ease seamless service support between CS and PS platforms (such as SoLSA and Camel).

In the future, network operators who have incorporated Gs functionality into their networks will be looking to connect UTRAN to their GSM/GPRS Core Networks with minimal changes (excepting those for service development, network and radio optimisation, network evolution and flexibility), thus the Gs interface should be maintained and enhanced for UMTS.

The Gs interface also offers opportunities for suppliers and operators regarding integrated MSC/GSN products (which may support internal proprietary Gs functionality as well as standardised MSC-GSN functionality). Operator's networks which have separated MSC/GSN nodes will be able to add integrated nodes into their GSM/GPRS/UMTS networks (and vice versa), depending upon the MM solutions developed for UMTS this could enable combined updates to be performed between (Gs supporting) integrated and separated nodes. If the Gs interface is not present operators will not be able to optimise resource between (integrated or separated) nodes.

9.3.1 Periodic updates

9.3.2 Why do we have Periodic updates

Periodic updates are within the network to increase the efficiency of the CN while also increasing the quality of service perceived by calling parties to mobiles. The periodic timer is set within the CN node to a figure which enables absent mobiles to have their (VLR based) information removed after the timer expires. People calling mobiles which are registered as 'detached' (either implicitly or via periodic expiry) will receive faster treatment of the call in the CFNrc case or 'Not been possible to connect your call' RANN case as the mobile is not paged by the network.

9.3.3 Support of periodic updates in UMTS

One of the current proposals for SRNS relocation [1, incl.: section 9.3.4, 2] propose that when in CMM connected mode (PMM idle) or PMM connected (CMM idle) the relevant location/routing updates to the (idle) CN are performed while in RRC connected mode.

For periodic updates the UE may be RRC connected (known to the UTRAN as 'active') when the (UE based) periodic timer is due to expire, the (idle) CN node will also have a timer about to expire and be ready to detach the UE.

If the methodology of [1, Section 9.3.4] is followed a location update will be performed within the same RRC connection to the (MM idle state) CN node to re-set the periodic timer.

9.3.4 Impact upon UMTS

The impact upon UMTS of this is that the UTRAN, UE and one CN node have an active session ('xMM connected) in place with accurate knowledge of the (periodic) attached/detached status of the UE. It is a waste of (valuable) radio resource for the UE to perform a LA/RA update purely to reset the periodic timer in the (idle) CN node: this also contradicts working assumption [1, section 11].

As UMTS is envisaged as a mass market system supporting very large numbers of mobiles within the network, many of these could potentially have very long (i.e. all day) duration (but low packet volume) Packet sessions (as per GPRS). It is folly to consider additionally loading the radio resource to update the (periodic) detach status of the mobile on the CN side of the radio interface when elements on the CN side of the radio interface already know the status of the mobile.

9.4 Authentication

9.5 Management of ciphering keys

9.5.1 Cipher Mode Control – 2MM concept

The assumptions in this section is based upon the assumption that ciphering is performed between UE and RNC.

It is assumed that in UMTS the ciphering key and the allowed ciphering algorithms are supplied by CN domains to the UTRAN usually in the beginning of the connection. Receipt of the ciphering command message at the UTRAN will cause the generation of a radio interface ciphering command message and, if applicable, invoke the encryption device and start data stream ciphering. The CN domain is noted if the ciphering is executed successfully in the radio interface and the selected ciphering algorithm.

When new connection is established from other CN domain, which is not having any connection to the UE, the new CN domain also supplies the ciphering key and the ciphering algorithms allowed to use to UTRAN in the beginning of the connection. This is due to the fact CN domains are independent from each other.

9.5.1.1 One ciphering key used in UTRAN

If it is assumed that only one ciphering key and one ciphering algorithm are used for all connections, this leads to a situation, in which there are two ciphering keys supplied from CN domains and only one of them is used.

To handle this situation, UTRAN must select either one of the ciphering keys. If there are no differences between the ciphering requirements¹ requested by two CN domains then, e.g., the first ciphering key and the algorithm is maintained (see Figure 28).

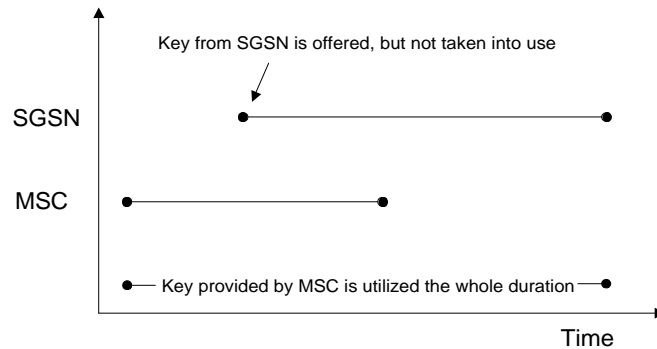

Figure 28. One ciphering key use in the UTRAN

As a result of the selection of the ciphering key between two different CN domains (if both CN domains have active connection(s) to the UE) either one or both of the CN domains do not know the present ciphering key used for the connection(s). Only UTRAN and UE know the present ciphering key used.

Further, if the case described in figure 1 is still considered and if after the MSC connection is released, but before SGSN connection is released, a new connection from MSC is established, the MSC may initiate a new authentication

¹ E.g. a requirement for more efficient ciphering algorithm that is currently used for the connection(s).

resulting in a new MSC ciphering key supplied to UTRAN. In this case, the UTRAN may follow the same key selection approach as it used previously, i.e., the first ciphering key is maintained².

9.5.1.2 Multiple ciphering keys used in UTRAN

It may be required to use more than one ciphering key for different radio access bearer, e.g., user plane bearers associated to one CN domain are ciphered by the ciphering key supplied by the associated CN domain. However, in the control plane only one ciphering key is used and therefore in the control plane there must be co-ordination between ciphering keys supplied by CN domains.

The co-ordination in the control plane is similar to what is presented for one ciphering key used in UTRAN option (ch. 2.1). In the control plane, UTRAN must select either one of the ciphering keys supplied from CN domains if both CN domains are active. The change of the used ciphering key in the control plane during active RRC connection is for further study.

9.5.1.2 Serving RNC relocation and ciphering

In GSM, when inter-BSC handover is performed, MSC sends the ciphering key and allowed algorithms to the target BSC in the BSSMAP HANDOVER REQUEST message. In GPRS, because the SGSN performs the ciphering, the inter-BSC handover does not cause any need for the ciphering key management.

For UMTS, the GSM approach is not applicable on the serving RNC (SRNC) relocation, because CN domains do not necessarily know the present ciphering key(s) used as it is described in the chapter 2.

It is recommended that the ciphering key(s) or a relevant information indicating used ciphering key(s) is transferred in the transparent UTRAN information field from the source RNC to the target RNC in the RANAP SRNC RELOCATION REQUIRED and RANAP SRNC RELOCATION REQUEST messages (see Figure 29.). In this way the present ciphering key(s) is transferred to the target RNC.

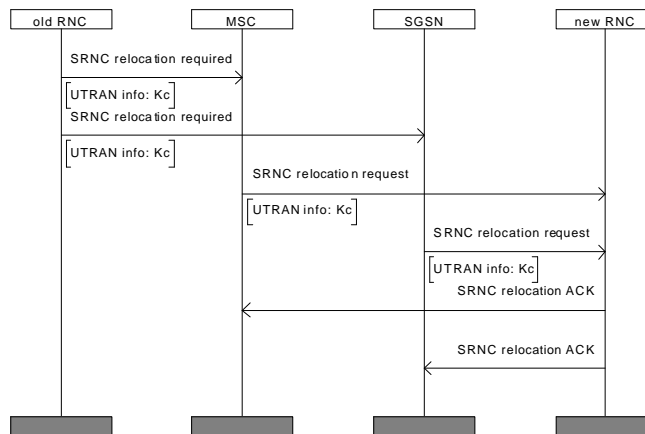

Figure 29. The ciphering key transfer in SRNC relocation procedure (one ciphering key)

² The change of used ciphering key during an active RRC connection is considered as a further study item.

9.5.2 UMTS-GSM handover

In the handover from UMTS to GSM, the ciphering key cannot be transferred transparently like it is proposed for UMTS. The CN has to build the BSSMAP HO REQUEST message, having the ciphering key from the MSC. 2G-SGSN receives its ciphering key from the old 3G-SGSN via Gn-interface as it is done in GPRS.

If the ciphering keys used in UMTS are different compared to GSM, e.g., the ciphering key length is different, both MSC and SGSN ciphering keys must be changed in UMTS-GSM handover. This type of interoperation is left for further study in this paper.

9.5.3 Interworking with 2g-MSC

In GSM, the A-interface BSSMAP [2] supports a transparent field in the BSSMAP HO REQUIRED and HO REQUEST messages, which allows to utilise the proposed solution also for GSM CN connected to the UTRAN.

9.6 Mobile IP in UMTS

9.6.1. Mobility Support

The possibility of combining different mobility handling systems should be considered. MAP, as being a widely spread protocol would form the basis for mobility handling in the evolution scenarios, but the combination of different mobility handling systems should be supported. As an example, the use of MobileIP, as a means to support discrete mobility, in combination with MAP subscriber handling, authorisation etc. should be supported. In that case Mobile IP would be used to handle discrete mobility in between access networks, whereas GSM/GPRS would be used for handling of subscriber data, charging mechanisms etc. Thus, Mobile IP would handle roaming and possibly handover between radio access networks (UTRANs), whereas the GPRS SGSN node –enhanced to include also some IP functionality – would be used for mechanisms such as authorisation and handling of encryption keys.

9.6.2 Mobile IP

A single generic mobility handling mechanism that allows roaming between all types of access networks would allow the user to conveniently move between fixed and mobile networks, between public and private as well as between PLMN's with different access technologies. The ongoing work in IETF Mobile IP working group [MIP WG] is targeted towards such a mechanism³. Thus it is important to offer Mobile IP also to UMTS users and UMTS must be developed to support Mobile IP. Mobility within the UMTS CN could also be handled by Mobile IP. This would allow transparency to networks external to the UMTS PLMN. Potentially, this would allow cost savings for operators and a broadening of the market for manufacturers.

It is important to understand the different driving forces:

- Mobile IP as an overlay to the UMTS-GPRS would make it possible to offer easy roaming between different types of networks
- An integration of Mobile IP within the UMTS CN would additionally allow the operators to use standard IP technology to a larger extent and thus lower the cost for deployment and maintenance of networks.

Operators shall have the possibility to offer Mobile IP to end customers for R99. A flexible approach should be taken in order to extend the use of Mobile IP to handle mobility within the UMTS CN. UMTS standards should be aligned to when new Mobile IP functionality, that is needed for the different stages, will come out on the market. As not all operators will introduce Mobile IP at the same time, compatibility with GPRS based PLMN's is needed. Such a flexible, yet backward compatible, approach is outlined below.

³ Note that in this text, Mobile IP is used in a wide sense. It refers to [RFC2002] and ongoing and future work in the IETF Mobile IP Working Group [MIP WG].

The concept of surrogate registration [TEP] allows MS's without Mobile IP to benefit from Mobile IP infrastructure by letting the network perform the registration with the HA on behalf of the MS. However, this issue needs further investigation.

9.6.3 A staged introduction of Mobile IP in the UMTS CN

Three stages, which are discussed more in detail further down, have been identified. Briefly, these are:

1. Stage 1 represents a minimum configuration for an operator, who wishes to offer the mobile IP service. The current GPRS structure is kept and handles the mobility within the PLMN, while MIP allows user to roam between other systems, such as LAN's, and UMTS without loosing an ongoing session, e.g. TCP.
2. The SGSN and GGSN can be co-located without any alterations of the interfaces. However, to obtain more efficient routing, the MS could change GGSN/FA, i.e. PDP context and care-of address after an inter SGSN handover if it is not transferring data. MS's which are transferring data during the inter SGSN handover could perform the streamlining after the data transfer is completed, using the old GGSN as anchor during the completion of the data transfer.
3. The third stage is to let MIP handle also handover during ongoing data transfer. The Gn interface is here only needed for handling roaming customers without support for MIP.

9.6.3.1 Stage 1 – Offering Mobile IP service

Mobile IP has the benefit of being access system independent, which allows users to roam from one environment to another, between fixed and mobile, between public and private as well as between different public systems. Assuming a minimal impact on the GPRS standard and on networks whose operators do not wish to support MIP, leads to the following requirements:

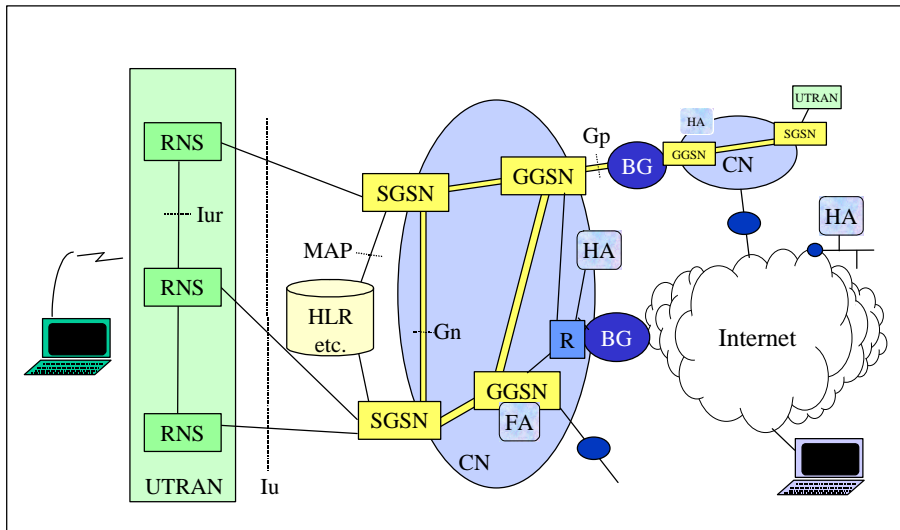

Figure 30. Core network architecture with GPRS MM in and between GPRS PLMN's and Mobile IP MM between different types of systems and optionally between GPRS PLMN's.

- The MS must be able to find a FA, preferably the nearest one. The underlying assumption is that FA's are located at GGSN's and that not all GGSN's may have FA's. One FA in a PLMN is sufficient for offering MIP service,

however for capacity and efficiency reasons, more than one may be desired. This means that the MS must request a PDP context to be set up with a GGSN that offers FA functionality.

- While setting up the PDP context, the MS must be informed about network parameters of the FA, e.g. care-of address.
- Furthermore, the interaction between the GGSN and the FA needs to be studied more in detail. With the assumption that FA care-of addresses are used, the FA needs to detunnel incoming packets and, together with the GGSN, map the home address of the MS to a PDP context.

Roaming can be handled either via the Gp interface or via Mobile IP. This is described in the section on roaming further down. It is assumed that the MS keeps the same care-of address as long as the PDP context is activated.

A typical network is shown in Figure 30. The detailed solutions of this stage are to be worked out in [MIP-SMG4].

9.6 3.2 Stage 2 – Intermediate GPRS-Mobile IP system

One way to implement a GPRS backbone is to co-locate the SGSN and GGSN, as depicted in Figure 31 . This might be favourable for operators with a strong interest in utilising standard IP (IETF) networks as far as possible and does not require any changes in the current GPRS protocol architecture.

In stage 1, the assumption was that the MS stays with the same care-of address, during a session, i.e. as long as a PDP context is activated. A very mobile MS, might perform several inter SGSN HO's during a long session which may cause inefficient routing. As an initial improvement, a streamlining procedure, with a temporary anchoring point in the GGSN, could be introduced:

If the MS is not transferring data while moving from one SGSN to another, a new PDP context could be setup between the new SGSN and its associated GGSN at the handover. The MS will get a new care-of address. The procedure for informing the MS that it has arrived to a new network has to be defined.

If the MS is transferring data, e.g. being involved in a TCP session, the MS would move from the old SGSN to the new one while keeping the PDP Context in the old (anchor) GGSN for the duration of the data transfer. Once the data transfer is terminated, the PDP Context can be moved to the GGSN associated with the new SGSN and a new care-of address can be obtained.

The buffer and forward mechanism, which already exists between the SGSN's for preventing data loss at inter SGSN HO's, will, with this procedure, be reused as it is. This procedure also has some advantage regarding the handling of firewalls, which are assumed to be attached to the GGSN's. Today, there is no standard for changing firewall during e.g. a TCP session.

As in the previous stage, the GPRS interfaces (Gn and Gp) need to be deployed for roaming customers, since there might be networks which not yet supports Mobile IP. Roaming between PLMN's can be handled either with Mobile IP or with GPRS.

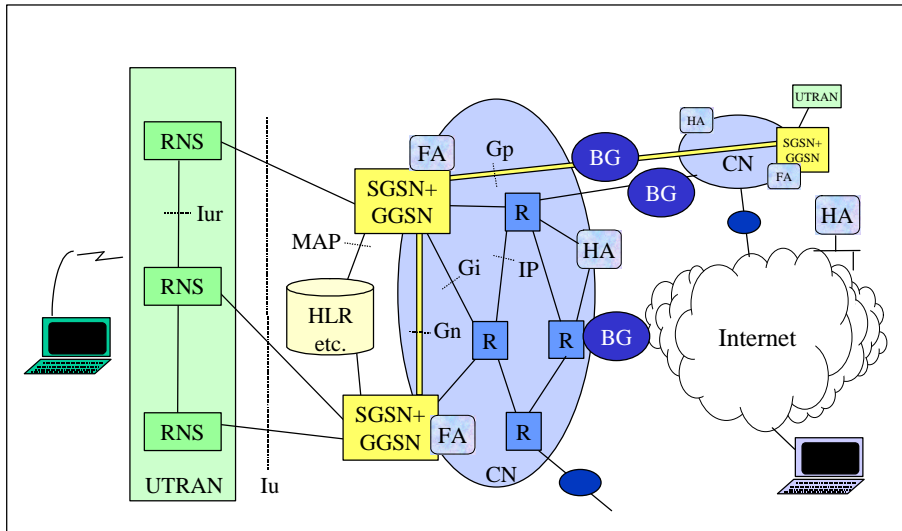

Figure 31. Core network architecture where GPRS MM handles active mobiles and Mobile IP streamlining at inter SGSN handover. The SGSN and GGSN are here co-located.

9.6.3.3 Stage 3 – Using Mobile IP for Intra System Mobility

The third and last stage is to let Mobile IP handle all intra system mobility, including all handovers between GGSN's or IGSN's. This is depicted in Figure 32, where the IGSN represents an integrated SGSN/GGSN. The Gn and Gp interfaces may optionally be kept to handle roaming customers, whose terminals do not support MIP and the operator's own customers roaming to networks without MIP functionality. The main difference compared to the previous stage is that lossless handovers between IGSN's must be handled. This is the target architecture of an ongoing study in SMG12 [MIP-SMG12].

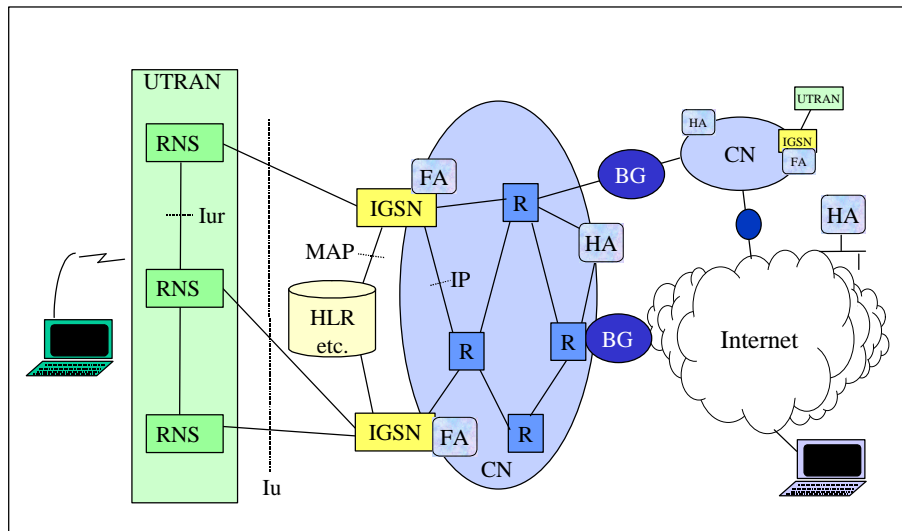

Figure 32. Core network architecture with Mobile IP MM within the CN and between different types of systems and between GPRS PLMN's.

9.6.4 Roaming

Depending on the capabilities of a visited network, two roaming schemes can be identified; GPRS roaming and MIP roaming. With GPRS roaming, we mean roaming via the Gp interface and the use of a GGSN in the home network, which is necessary when the visited network does not offer any FA's. In those cases where the visited network offers a FA, either a GGSN/FA in the visited or in the home network can be utilised. Networks, which use Mobile IP for all its own customers can provide GPRS roaming to visiting users by deploying the Gn and Gp interfaces.

9.6.5 Mobile IP and UMTS terminals

The mobile equipment needs to be enhanced with MIP software. For compatibility with other systems, it is of great importance that standard IETF Mobile IP and not a special UMTS version is used. Although it should be kept to a minimum, any interaction between the IP layer and the "UMTS layer" needs to be identified and defined. To avoid future updates of the mobile equipment, it should be considered to include the needed UMTS specific functionality of all three stages in the MS at once.

9.6.6 Surrogate Registrations

The concept of surrogate registration has a potential use in supporting non Mobile IP aware terminals using a Mobile IP based infrastructure. Instead of the MS performing registration with the Home Agent according to [RFC 2002], the FA could surrogate the mobile node in performing Mobile IP registrations with the Home Agent. One solution is proposed in [TEP] (Tunnel Establishment Protocol). However, surrogate registration may cause IP level authentication to be dependent on UMTS authentication and hence increase the dependence of Mobile IP on the access technology. Further study is required on this topic.

9.7 Structure of air interface layer 3

- Connection Management
- Session Management
- Starting point is relevant parts of GSM 04-series, e.g. GSM 04.08

9.8 Iu reference point

9.8.1 General

As a first step, UMTS will be based on the GSM/GPRS network, i.e. one circuit switched and one packet oriented domain. Due to the differences of the domains, the Iu reference point will be realised by two Iu instances, one for each domain. This enables each domain to develop according to their specific characteristics. At the same time, an aligned view of the Iu reference point should be achieved where this is deemed suitable

9.8.2 Control structure for the Iu reference point.

- A multi-vendor interface shall be defined at the Iu reference point (Iu interface). The interface embodies a protocol suite allowing different protocol stacks towards the PSTN/ISDN domain and the IP domain.
- Over the Iu interface, user information to one UE is carried in one or several logical user flows, controlled by a signalling protocol (RANAP). Additionally some control elements (potentially relevant for only one domain) may be carried inband in the user flows.
- A common syntax for RANAP messages for both the IP and the PSTN/ISDN domain is the target as long as the functionality of either domain is not compromised.
- A guideline for defining the control procedures over the Iu reference point is to reuse, to the extent possible, control procedures defined in BSSMAP and BSSGP/GTP. The use of BSSMAP and BSSGP/GTP as the base when defining the control procedures over Iu does not preclude new control procedures to be introduced over Iu reference point.
- For each domain the protocol stack used by RANAP may be based on one of SS7, TCP/IP or a combination (e.g. SCCP on TCP/IP or UDP/IP). The protocol stack used by RANAP may be different for the PSTN/ISDN domain and the IP domain.
- The protocol stack used by the user data transport over Iu may be different from the protocol stack used by RANAP. Furthermore the user plane protocol stack may be different for the two domains.

9.8.3 Iu reference point - User plane towards IP domain

- The standard shall support that the user data flows transported over the Iu reference point to/from the 'IP domain' shall be multiplexed on top of common layer 2 resources.
- One or several AAL5/ATM Permanent VCs may be used as the common layer 2 resources between the UTRAN and the 'IP domain' of the CN. The reason for usage of several permanent AAL5/ATM VCs may e.g. be for load sharing and redundancy. It is also possible to use one switched VC per user flow (PDP context or radio access bearer).
- An ARQ mechanism between UE and Core Network (LAC-U) shall not be used to prevent loss of data at a change of the Iu connection point. For all cases of a change of the Iu connection point loss of data shall be prevented by forwarding packet data not yet transferred via radio from one UTRAN entity to the other. The

forwarding is done via the Iu bearer as the Iu resources provide a higher trunking gain and therefore better adapted for bursty data transfer.

- The requirement for a decreased residual error rate (10⁻⁸) shall be provided by an RLC option and not by an additional ARQ layer LAC-U.
- The lossless relocation/handover requires no Iu flow control and no buffering of packet data in the Core Network as the relevant Iu bearer with its RLC entity is always established and the UTRAN entities forward packet data between each other in the case of relocation or handover.
- Complete user data packets shall be transferred without any segmentation by the Iu packet bearer. The UTRAN RLC shall be capable of transferring these user data packets up to a maximum size. An efficient packet data transfer path between the UE and the Core Network is gained by this approach without a second ARQ layer LAC-U, without flow control for the Iu packet bearer and without packet data buffering in the 3G-SGSN. This approach supports real time packet data transfer as well as transfers with low residual error rate. Furthermore, a minimised number of layers and functions simplifies the UE and it reduces the execution time and the performance requirements for re-establishing the Iu packet bearer at a change of the Iu connection point or at re-negotiation of QoS parameters.
- Any problems within the UTRAN which cause loss of data addressed to a UE shall be indicated to the 3G-SGSN to maintain the conformance of the data volume counted by the 3G-SGSN with the successfully transferred data volume. It is FFS whether this mechanism provides a degree of conformance required for volume dependent charging.

9.8.4 Proposals for the User Plane for the IP Domain

The various proposals for the user plane for the IP domain at the Iu reference point can be classified in three broad categories.

Editors Note: Finally, a single protocol stack for the user plane for the IP domain will be specified. Currently, the following proposals are being evaluated.

Proposal 1: The proposed protocol stack is shown in Figure 1. This proposal is very similar to the user plane protocol stack in GPRS.

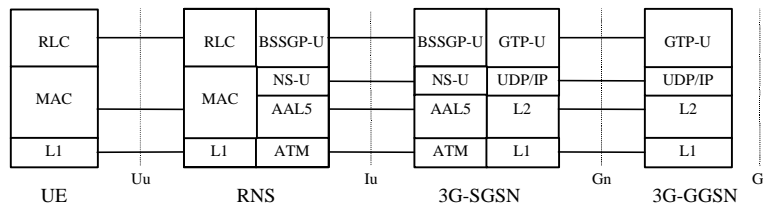

Note: Protocol layers above RLC and BSSGP-U are outside the scope of this contribution and FFS

Figure 33: User Plane Protocol Architecture for Proposal 1

Proposal 2: The proposed protocol stack is shown in Figure 2. In this proposal, a tunneling protocol is used between the SGSN and the UTRAN. Further, it is proposed that the tunneling protocol used is an evolution of the GTP protocol used in GPRS.

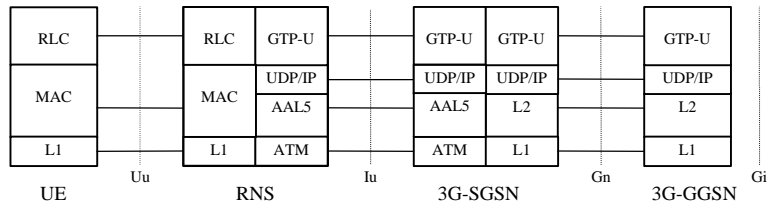

Note: Protocol layers above RLC and GTP-U are outside the scope of this contribution and FFS

Figure 34: User Plane Protocol Architecture for Proposal 2

Proposal 3: The proposed protocol stack is shown in Figure 3 (from DTR 23.20). In this proposal, a tunneling protocol is once again used at the Iu reference point. However, in this proposal, the SGSN does not perform any user plane functions at Layer 3.

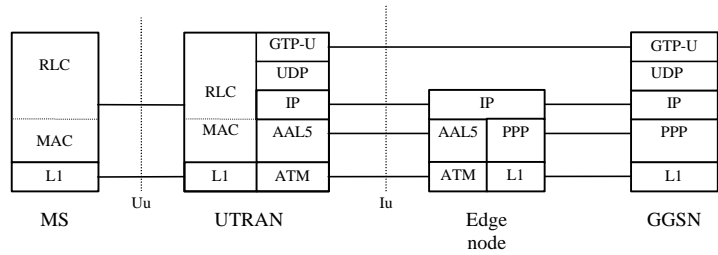

Figure 35: User Plane Protocol Architecture for Proposal 3

9.9 Dualmode operation (GSM/UMTS)

9.9.1 Will dualmode terminals also support GPRS?

9.9.1.1 Handovers between GSM/GPRS class A and UMTS terminals

In the following some problems and suggestions to solve the problems are made concerning the case where UMTS must support handovers from GSM to UMTS and/or UMTS to GSM for mobile stations with CS and PS service capability (GPRS class A).

9.9.1.2 Handover from GSM to UMTS

This type of handover could be needed, e.g., due to traffic reasons in a congested GSM network. In GSM the control for CS connection remains in the MSC from which the call was originated. This is called anchoring. Figure 36 illustrates the situation before the HO into UMTS (i.e., to UMTS UTRAN).

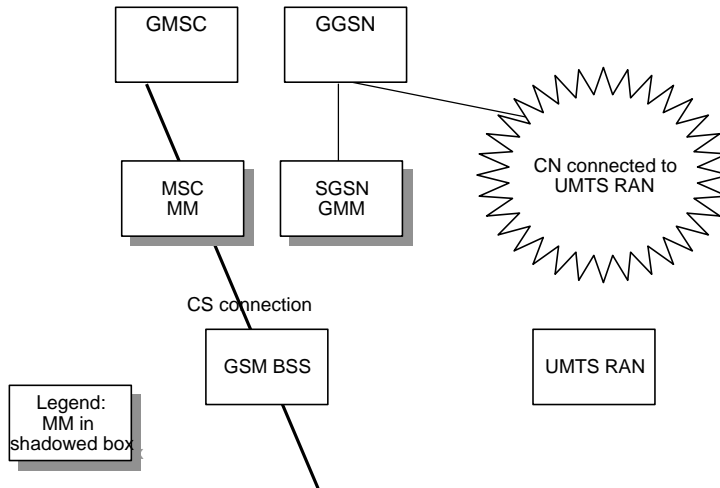

Figure 36. Before HO to UMTS from GSM. The PS services are provided from SGSN in GSM.

In order to have access to PS services after the HO, the MS has to perform the necessary update, obviously. The reason for this is that there are no means to change SGSN in GSM without doing so. However, as there is an active connection from GSM MSC, no updating can be done for CS services (i.e., to MSC connected to UMTS UTRAN) until the call has ended, i.e., the control and MM for CS remains in GSM. As a result, only the PS MM can be activated in UMTS and thus the MM is split into two due to the HO.

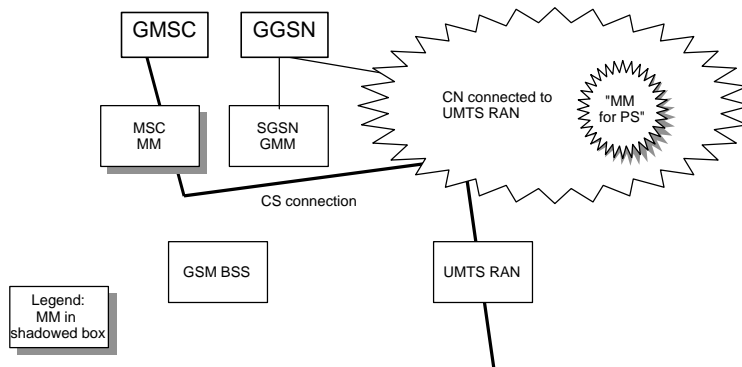

Figure 37 After HO to UMTS from GSM.

The PS services can only be accessed from UMTS CN. To avoid severe limitation on accessing the PS service during the length of the CS connection, "MM for PS" must be setup into UMTS CN. To support that, the MM in UMTS CN has to be able to be split into two like MM in GSM. Moreover, to support PS access the UTRAN needs to perform coordination similar to the one required for the core network architecture with two edge nodes (e.g. scenario 2).

9.9.1.3 Handover from UMTS to GSM

Figure 38 illustrates the situation before the HO; anchoring is assumed in UMTS CN. This type of handover could be needed, e.g., due to limited coverage of UMTS.

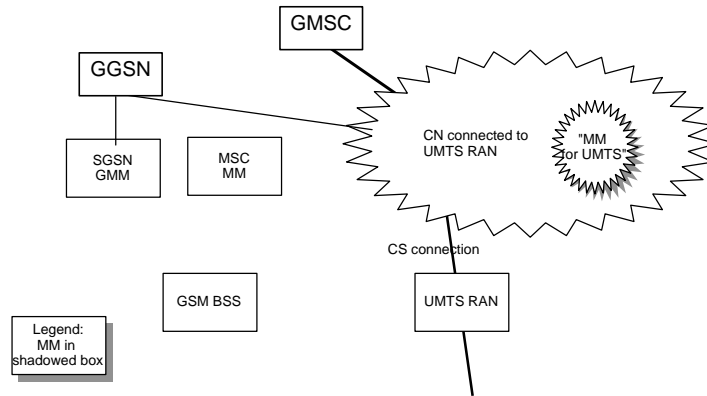

Figure 38 Before HO from UMTS to GSM.

This type of handovers are seen as important especially in the first stages of UMTS due to limited coverage. Without these, the end user perception may be seriously affected.

Again, to have access to the PS services after the HO, an appropriate update is needed and also no updating can be done for CS. As a result, MM instance only for PS can now be activated in GSM as long as the call lasts and as a result, the MM in UMTS is split into two due to the HO..

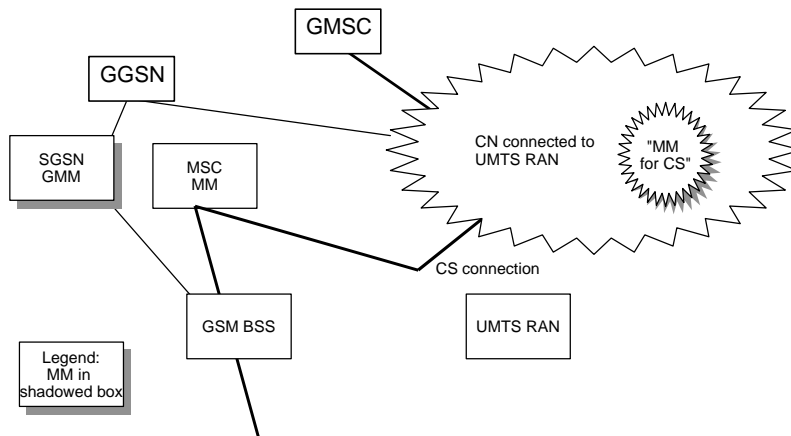

Figure 39 After HO from UMTS to GSM.

To have access for PS service in GSM, the "PS part of MM in UMTS" has to be transferred to GSM.

9.9.1.4 Suggestions

From the discussion above one can suggest that to support handovers between UMTS and GSM for class A type of mobiles:

1. UMTS MM must support some distinction between CS and PS services in the registration related procedures. An example is a dedicated update/cancel only to PS services in UMTS. This is likely to affect to the states of UMTS MM sublayer in MS and CN (independent of the selected MM solution)
2. The MS has to be capable of handling the GSM – UMTS dualism
3. The UTRAN has to support the operation. Required functions bear resemblance to the architecture where the core network has two edge nodes (MSC, SGSN).

Some of these problems may be alleviated if the UMTS core network node provides also GSM functionality (A and Gb) and there is no need to change the UMTS core network node during the handover. This is for further study.

Requirements due to handover for dualmode "UMTS class A" – GPRS class B terminal are:

- Handovers between GSM and UMTS for N-ISDN and packet oriented services (e.g. IP)
- Idle mode operation of dual mode terminals (e.g. cells in same or different location areas)

9.10 Anchor concept

UMTS Mobility Management (UMM) for release 99 shall use packet anchoring at the GGSN, providing this meets the QoS requirements, including those for real time services.

Disassociation of SRNS relocation and PS session transfer should be evaluated for release 99

9.10.1 Introduction to the concept of anchoring communications in GPRS

GPRS is being developed to include Quality of Service, this includes real time aspects. At present within GSM/GPRS the Core Network part of inter SGSN RA update procedure- is used to maintain communications within the network for a change of SGSN. GPRS will need development to support real time QoS requirements, the current mechanisms for changing the current SGSN (inter SGSN RA update) may also need developments to maintain the QoS requirements.

For UMTS the notion of Serving and Drift RNC provides a no loss of data at Hand-over inside a UTRAN as long as SRNS relocation (or a UMTS<=>GSM handover) is not performed (use of RLC between SRNC and UE in case of non-real time packet data, and use of soft handover in case of real time). The SRNC could be considered as an "anchor" point for the UTRAN. Therefore only the case of SGSN change induced by SRNS relocation has to be considered.

Within the UMTS CN two proposals have been made to satisfy the QoS requirements, the anchor SGSN concept and the non-anchor SGSN concept, both are illustrated in Figure 40 and are discussed in the following sections.

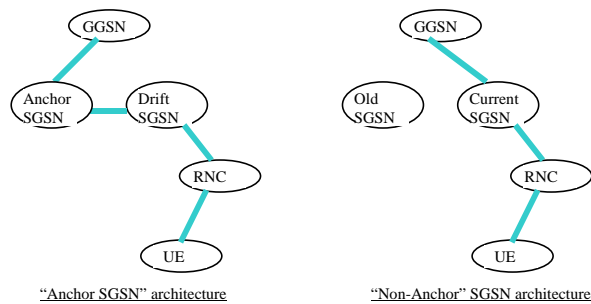

Figure 40: The "anchor SGSN" and the "non-anchor" SGSN architectures

9.10 2 The Anchor SGSN concept

This section proposes that the current technique for anchoring communications within the MSC is considered for application to the QoS based GPRS communications (i.e. between SGSNs). This technique is termed 'the Anchor SGSN concept' and is used to maintain the communications between the GGSN and the UE, with the SGSN(old) making a bearer link to the SGSN(new).

It should be noted that this concept may be applicable for UMTS as well as GPRS.

9.10.2.1 Requirements for the anchor SGSN

The requirements for the support of the SGSN anchor concept are discussed below

GPRS: With added QoS

To date GPRS has used a number of different QoS Criteria, however the GPRS (and UMTS) community have been looking at enhancing this to enable better support for real-time type features. The current Core Network GPRS inter SGSN RA update (SGSN change) relies upon the Old SGSN to suspend and buffer packet transmission, the new SGSN to interact with the GGSN/HLR to maintain the active session. The new SGSN then re-commences transmission and buffered packets (from the old SGSN) are passed to the mobile. The impact of this is potential breaks in transmission which would not satisfy Real-time/QoS requirements.

The Core Network part of GPRS Cell re-selection: convergence with (inter MSC) handover?

As GPRS adopts real time QoS, developments will be needed within the routing elements (GSN) to cater for the real-time nature of the packet communications. One upshot of this is within the QoS based environment the resource reservation paradigm moves towards a 'circuit switched' one (with resources 'reserved' for the QoS stream). With this in mind the support of the CN part of inter SGSN RA update in a QoS environment could become closer to a 'circuit switched' handover where the old and new paths are 'connected/bridged' during the actual handover. For UMTS the SRNS relocation within a QoS based GPRS network may require developments between SGSN to enable the paths to be connected at an inter SGSN level, rather than the current method of using the GGSN. Effectively the current GPRS inter SGSN RA update mechanism uses the GGSN as the anchor point.

To maintain the QoS requirements during a change of SGSN an SGSN based anchor point (similar to the current VMSC based anchor in GSM CS) could be applied. Following the successful SGSN change it may be possible to optimise the packet routing between the GGSN and new SGSN, this requires further study.

SGSN based Anchor

The adoption of an SGSN based anchor could ease some of the problems highlighted within *UMM* where the MM becomes split between GSM/GPRS and UMTS when a handover between the two radio mechanisms occurs. At present the (GPRS) MM location follows the Packet Switched serving node (SGSN) as it moves within and between

the networks, whereas the Circuit switched (CS) MM remains within the anchor MSC. Further study should be made to see if the concept of anchoring of all services within the 'initial' network (network where communications were initiated) will ease the 'split MM' problem.

MM enhancements

Within the Circuit switched world the MM information is retained at the old MSC following an inter MSC handover and no location update is performed until the CS session (call) has been terminated. The adoption of a similar mechanism for Packet switched Services could ease the GSM-UMTS MM problem. If a CS session is in place the location update/routing area update would be constrained until the CS session is terminated (from the UTRAN perspective any PS packets would be routed over the common RRC session with no need for paging (in the now 'new' UTRAN RA/LA)).

9.10.2.2 Developments of GSM/GPRS for the SGSN based anchor

To enable the SGSN anchor concept to be supported the following developments will be needed to the contemporary GSM/GPRS network: these should be linked in to the overall UMTS developments:

- a) Support for GPRS/UMTS QoS during SGSN change (inter SGSN RA update). Modification of the contemporary inter SGSN RA update mechanisms to become similar (if not converged with) GSM inter MSC handover type mechanisms.
- b) Modification of the inter SGSN signalling mechanisms to support the transfer of related information directly between SGSNs (e.g. SRNC relocation parameters, cipher/security information).
- c) Development of mechanisms to support single MM (the relation of updates between the MSC/SGSN and HLR is for further study). The Gs interface may be enhanced to support this capability.

Developments in contemporary GSM/GPRS network are also required to enable the UMTS <=>GSM/GPRS interworking since the anchor point is currently the GGSN.

9.10.3 The non-Anchor SGSN concept

The non-anchor SGSN concept may be viewed as the method currently used within GPRS (R97) for a change of SGSN.

9.8.3.1 Current GPRS operation

Current GPRS does not use an anchor SGSN (the SGSN used at PDP context activation may not be used by the MS during the lifetime of this PDP context).

The main reason is that, while in Circuit Switched GSM the call duration is very short, the PDP context duration may be very long (and the user be very far away from the SGSN where it activated the PDP context).

Furthermore, current inter-2G-SGSN mechanisms do not support a 'drift' SGSN since, at the reception of a downstream PDU, it is not possible to page a MS in standby state through another SGSN (there is no support of this requirement for a (R97) SGSN).

Note: When in (UMTS) RRC Connected mode, the UTRAN caters for paging of the mobile when in PS CONNECTED.

9.8.3.2 Developments of GSM/GPRS for the non-SGSN based anchor

To satisfy the identified requirements for GSM/GPRS/UMTS R99, the following developments will be needed to the contemporary GSM/GPRS network:

- a) Support for GPRS/UMTS QoS mechanisms during inter SGSN RA update, this will involve continued linkage of the GGSN with the inter SGSN RA Update.

The current mechanisms for inter (2G)SGSN RA update are different to the mechanisms for inter MSC handover .

9.10.4 Analysis and comparison of the “anchor SGSN” and “non-anchor SGSN” concepts

The following aspects need to be considered when considering inter SGSN RA update concepts for GPRS/UMTS:

- Support of QoS requirements (e.g. transfer delay (for real time traffic), reliability (ability to handle correctly traffic requiring a high reliability), service interruption (for real time traffic))
- Relationship to mobility management
- Support of Class A/Simultaneous mode operation
- Resource usage within the network
- Developments needed within the standards

9.10.5 Support of QoS requirements

Transfer delay

Both the network and radio paths create delay within GPRS/UMTS communications. The non-anchor mechanism always crosses three GPRS nodes during communications (RNC, current SGSN, GGSN). The “anchor SGSN” architecture uses the same 3 nodes until an SGSN RA update occurs, then a new node (the drift SGSN) is added, with the communications ‘anchored’ at the initial SGSN. After an inter SGSN RA update in the SGSN anchor mechanism 4 nodes are used (RNC, drift SGSN, anchor SGSN, GGSN), the anchor SGSN relays user packets to the drift SGSN. The “non-anchor” architecture provides a lower network transfer delay and a lower jitter on this delay (less nodes implies less queuing). This is likely to be an issue for real time traffic such as VoIP. The impact of this needs to be assessed in relation to the delay over the radio path.

Reliability

Within the UTRAN the (acknowledged) RLC layer between UE and SRNC provides the reliability required by some (non real time – high reliability) traffic within the UTRAN. When there is a change of SRNC:

- - either the RNCs (if there is no LLC in the protocol definition of Iu) using packet transfer between old and new RNC
- - or the CN (if there is an acknowledged LLC in the protocol definition of Iu) using packet transfer between old and new SGSN

can repeat the non acknowledged packets ensuring the reliability requested by the user.

The same reliability can be provided in both “anchor SGSN” / “non-anchor” SGSN architecture.

It should be noted that ARQ mechanisms (using acknowledged mode with repeats) do not guarantee to avoid break in transmission for real time applications (such as speech/VoIP).

Service interruption at SRNS relocation

With the anchor SGSN architecture service interruption may exist during the change over of path from old RNC to new RNC, mechanisms such as parallel paths could be used to prevent or minimise this. The anchor SGSN would act as the anchor for multiple PDP contexts (potentially to different GGSN which could be located within different networks).

With the non-anchor mechanism service interruption may exist during the change over of path within the GGSN between the old SGSN and the new SGSN. The impacts (upon timing of inter SGSN RA update) of multiple PDP contexts (potentially to different GGSN which could be located within different networks) needs to be studied.

The impact on nodal buffering and path change requirements for both concepts

(e.g. between GGSN and old/new SGSN in non Anchor concept, and between anchor SGSN and drift SGSN in anchor concept), combined with the support of real time and non real time traffic needs to be assessed further.

Network resources used

As shown in Figure 40, the non-anchor SGSN architecture requires less nodes and transmission resources than the anchor SGSN architecture. However, the impacts upon the network resources in terms of signalling, buffering and processing load requirements need to be addressed.

Quality of service requirements

The optimum mechanism to satisfy the service requirements need to be considered, for example for a non real time, long duration packet session the anchor SGSN may not be optimum. Alternatively, for a real-time short duration packet session the non-anchor concept may not satisfy the QoS requirements at SRNS relocation. However, if SRNS relocation is not performed for real-time short duration packet session, there is no break in transmission at all (It is acceptable since the duration is short).

A mix of solutions may need to be considered in relation to the Quality of Service requirements of the packet session.

9.10.5.1 Support for Class A (GSM/GPRS) and UMTS Simultaneous Mode operation

Within GSM/GPRS the mechanisms used within the MS and the network to support Class B/C operation are different to those required for Class A. Simultaneous mode is required within UMTS (R99) which will place requirements to the GSM/GPRS/UMTS R99 standards. The impacts on the network and MS usage and control of radio resource need to be addressed.

9.10.5.2 Mobility Management

For MM point of view, interworking with 2G-SGSN has to be considered. A non-anchor SGSN architecture makes it easy since the GGSN is the anchor point in both 2G-GPRS and UMTS networks. The concepts chosen for UMTS and GSM/GPRS for R99 need to be compatible.

In the case SGSN anchor concept is introduced in R99 GPRS, several issues have to be considered:

- A new relaying protocol has to be introduced since BSSGP does not fulfil this requirement,
- The MS behaviour has to be modified: in standby state, it has to initiate a cell update instead of a RA update,
- The drift SGSN has to route the cell update to the anchor SGSN it does not already know,
- When receiving a downstream PDU, the anchor SGSN has to page the MS under another SGSN. The use of P-TMSI may lead to conflicts since the same P-TMSI value may be already used for another MS.
- Interception and charging aspects, since the GGSN and the MS could be in different regions.

The current mechanism with UMM uses different mechanisms for PS and CS MM. The impacts of both mechanisms on GPRS MM/UMM and security/ciphering need to be addressed.

Within the anchor concept there are no RA updates as long as the MS has an active PDP context via anchor SGSN.

The non-anchor concept leads to RA updates with every change of SGSN; however, there is no RA update as long as the SRNS is not changed since the SRNS acts as an anchor point in the UTRAN.

The impacts of inter SGSN RA update for both anchor and non anchor solution in conjunction with location based services (such as SoLSA) needs to be addressed.

9.10.5.3 Comparison of developments needed within the standards for GSM/GPRS/UMTS R99

- R99 will include the support of QoS within GSM/GPRS and UMTS.

- Class A operation and UMTS simultaneous mode will be required for R99.
- The anchor SGSN concept would include the specification of drift SGSN and packet forwarding mechanisms.
- The non-anchor concept may need enhancement to satisfy the QoS concepts and will need development to ensure the interruption for inter SGSN RA update can be achieved within the QoS requirements.
- The changes and developments needed to GPRS R97 to satisfy these requirements as well as inter-working to pre R99 networks needs to be addressed.

9.11 Quality of service

- Application/End to end QoS
- QoS Segments (e.g. Radio, UTRAN, CN, Internet)
- QoS Mapping (between different segments/layers)
- Radio Access Bearers
- Resource management
- Interfaces/APIs between Application, TE, MT
- Charging of QoS aware applications

9.12 Others

9.12.1 Evolved GPRS/IP support for Multi-media service

The following developments are needed within IP/GPRS to support the expected multi-media requirements of UMTS (note this list is not exhaustive):

QoS for GPRS: To enable real-time 'streaming' developments.

Adoption of IP Telephony, H.323 and equivalent PSTN/Internet technologies: To support the control and interworking of multi-media and telephony applications with non-UMTS networks.

Interrogation of the HLR with the Gateway functionality: To enable terminated communications to be delivered to the mobile terminal. This can include the PIG and H323 functionality.

Figure Z illustrates a potential architecture which could be used to deliver telephony and multi-media features.

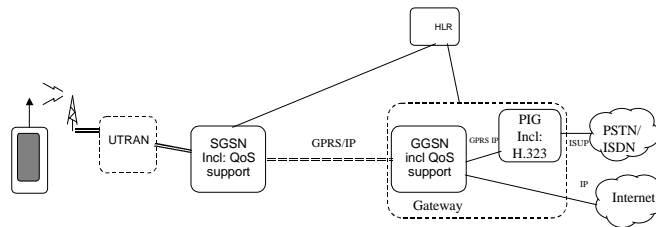

Figure 41: Evolved GPRS/IP support for Multi-media services

Telephony and multi-media requirements for UMTS may be supported via the evolved IP/GPRS network of Figure Z. This architecture does not need a separate non-IP based circuit switched (MSC) platform.

- Multimedia service control
- Phasing. What is for release -99, -00, etc. ?
- Network migration
- Handling and type of coded speech over Iu
- Location of ciphering functionality
- Link access control for user data (LAC-U)
- Data compression
- Allocation of resources of Iu

9.12.1 Separation of switching and control

Proposed Architecture

In this section the concept of a logically Separated Call Control (SCC) server is introduced. Currently CC is integrated with each of the MSCs in a network. Here it is suggested (and shown in figure 1) that a single CC function is implemented which is logically separated from the switch. The physical location of the SCC server is an implementation issue. Examples of implementation include:

- SCC integrated with IWU.
- SCC integrated with one or more switches. In this case a IWU may not be required between the SCC and the switch(s) with which it is implemented. IWUs would be used to connect to other switches.
- Standalone SCC.

Data required by the SCC could be held locally so as to reduce signalling load. This is likely to include data currently held in the HLR and VLR and a network resource database which allows the SCC to determine what network resources are available and record the state of resources e.g. used, reserved or free. Figures 2 and 3 show the signalling flows in the network for mobile originated and mobile terminated calls respectively.

In figure 1 MM is shown as being integrated with the SCC. It could equally well be separated from the SCC.

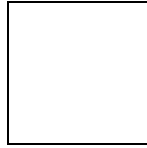

Figure 1 Network Architecture

Notes:

1. DBs represents all databases necessary for SCC operation, e.g. HLR, VLR, Network Resource database.
2. MAP (with some new operations) could be used here which would probably represent minimum change. Alternatively a more general protocol such as MGCP could be used which would represent more change but have the advantage that the switch would be made more generic.
3. ISUP (with some modified messages) could be used to communicate between the SCC and the transit switch of a neighbouring network.
4. This signalling is shown to pass through the transit switch as this is a likely (but not mandatory) route for it to take. The logical connection is between the SCC and the neighbour network.
5. MAP (with some new operations) could be used here which would probably represent minimum change. Alternatively a more general protocol could be used which would represent more change but have the advantage that the databases would become more generic. If an IN implementation is adopted the SSF could form part of the SCC which could communicate with an SCF via MAP or INAP which in turn could communicate with the DB via DAP.
6. This interface could be the same vendor specific propriety interface that is implemented today internally to the MSC.

Mobile Originated Call

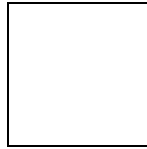

Figure 2. Signalling Flow for MO call.

Notes:

1. A modified SRI operation could be used by the SCC to request routing information from the databases. The response contains all the information required to route the call from the serving switch to the point of interconnect.
2. A modified IAM and ACM could be used to communicate between the SCC and the transit switch. Because the SCC serves multiple switches a switch ID (in addition to a route ID and circuit ID) is required.
3. EST (establish) and EST ACK could be a new MAP) or could be provided by a new protocol such as MGCP. Here EST is used to instruct the switch to establish the backward connection. EST ACK confirms that the required connection has been established. Note that the SCC executes the EST operation to all involved switches simultaneously. In the event of a handover the SCC would execute EST operations only to those switches involved in the handover. In the event that the neighbour network is not controlled by an SCC the transit switch is unlikely to be involved.

4. Here EST is used to instruct the switch to establish the forward connection.

Mobile Terminated Call



Figure 3. Signalling Flow for MT Call.

Notes:

1. A modified IAM and ACM could be used to communicate between the SCC and the transit switch. Because the SCC serves multiple switches a switch ID (in addition to a route ID and circuit ID) is required.
2. A modified SRI operation is used by the SCC to request routing information from the databases. The response contains all the information required to route the call from the serving switch to the point of interconnect.
3. For clarity MM is considered as part of SCC here.
4. EST (establish) and EST ACK could be a new MAP) or could be provided by a new protocol such as MGCP. Here EST is used to instruct the switch to establish the backward connection. EST ACK confirms that the required connection has been established.
5. Here EST is used to instruct the switch to establish the forward connection.

9.12.1.1 Benefits

The separation of switching and control functions offers the following benefits:

Architectural Flexibility: The separation of bearer from the control allows flexibility in locating the desired functions. (functions could either be centralised or distributed). For instance, the switching and call control functions performed by a circuit or packet switch can now be separated and located in physically distinct locations. The control functions (all or a part thereof) could be located in a “call control server”, which can provide the information necessary to appropriately route the bearer. Further, this allows the use of platforms designed specifically for the task being performed to be used. Dedicated platforms will allow easier and faster software development and less work will be involved in rolling out new software versions.

Efficient Utilisation of Network Resources Given that most of the traffic associated with a call is bearer traffic, optimal routing of bearers (facilitated by separating control from the bearer) allows efficient utilisation of network resources. For instance, call control may be routed to a “ Call Control server” for purposes of address resolution, billing, enabling of services, and others, but the bearer does not have to traverse through the call control server. Further, optimal routing can be maintained during mobility (the concept of an anchor MSC can be removed) since the bearers can be re-routed after a change in location. Optimising the routing in this way will have greater significance for UMTS calls which are likely to be high bandwidth and may also consist of multiple streams.

- Further optimal routing can be achieved in the case of call divert.

Bearer Flexibility and Robustness: The separation of bearer and control allows the communicating parties to negotiate the resources required (even possibly re-route the bearers) even after call setup has been completed. Bearers could be re-routed during a call due to a change in the performance required or to work around failure of network elements.

Future-Proof: The separation of bearers from control makes the protocols used more modular (than before). For instance, the same control protocols can be used over multiple transport technologies. Further, the same control

protocol can be used for establishing multiple bearer types. This facilitates improvements in technologies being used with minimal impact.

9.12.1.2 Drawbacks

Separation of switching and control means defining the interfaces between the various control functions (such as call control, mobility management, session control, etc.) and the switching functions (i.e., switching matrix). For example in the case of a GSM MSC, this would mean defining an open interface between the MSC service switching functionality and the TDM switching matrix.

For packet data nodes, the separation might be more realistic as a client-server type of architecture is more natural in that domain. However, this is a deviation from the current GPRS and therefore may require additional standardisation effort.

9.13. New Handover functionalities

The radio access network has to be capable of connecting to a variety of existing core networks. This leads to a requirement that the UTRAN will be allowed to connect with evolved forms of existing CNs. There will be the need to support new Handover functionalities between UMTS and 2G systems.

The support of multimedia services and the separation of Call Control and Connection Control (many connections: telephony, video, data could be associated with one single call and handed over separately), together with a micro or pico-cellular environment will cause increased complexity of Handovers compared with GSM.

Developments will be needed of the contemporary GSM/GPRS platforms to enable handover/cell reselection of communications between GSM/GPRS and UMTS. To enable this specific developments are needed for:

- Handover/cell reselection of communications which have inherent delay and error requirements (e.g. speech as for contemporary GSM circuit switched and speech/ video). (This may be viewed as an equivalent of GSM circuit switched handover).
- Handover/cell reselection of communications which may not have inherent delay requirements but do have error requirements (e.g. packet data communications such as IP/GPRS, file transfer, SMS). (This may be viewed as an equivalent of GPRS cell-reselection).

This also requires the ability to potentially 'negotiate' and modify communications parameters when handing over between GSM/GPRS and UMTS.

- It would be useful to provide new procedures in UMTS in order to make handover a totally Radio Resource Management procedure fulfilled as far as possible by the BSS without the intervention of the NSS part. The proposed interconnection of BSSs to allow for handover streamlining could be a step in this direction. (This may be difficult when performing hand-over between different environments, and a traditional GSM-like handover procedure is likely to be used in this case).
- It is likely that the network performance during handovers will be increased by restricting handover to the access network, leaving the core Network to deal with the Streamlining procedure without any real-time constraints. (In the case of a successful GSM inter-BSC handover, eight messages are exchanged real time on the A interface between the MSC and the two BSC; if Streamlining is used, this could be potentially reduced to two messages (Streamlining Request - Streamlining Acknowledge) with a significant saving in the signalling overhead.

As part of the overall QOS negotiation between user and network, mechanisms will be needed to enable parameters such as handover delay, jitter, packet/information loss/acceptable error etc. to be applied as part of the communications path requirements utilised during the communications 'session'.

A number of options are available to support handover within the UMTS Core Network; real time support within the core network, real time handover within the UTRAN with subsequent 'streamlining'. Irrespective of the final mechanism developed within the UMTS Core Network for UMTS handover, functional developments are needed within the Core Networks (both GSM/GPRS and UMTS) to support handover between UMTS Core Networks and evolved GSM/GPRS core networks.

9.14 Reduction of UMTS signalling

9.14.2 Turbo Charger

The signalling load associated with subscriber roaming can be high when either the location areas are small or the subscriber travels significantly. The Turbo-Charger concept aims to optimise signalling associated with subscriber data management by assigning one MSC/VLR to perform the Call Control and Mobility Management functions while the subscriber remain attached or until signalling routes require further optimisation.

The benefits of the Turbo-Charger concept are:

- the substantial reduction in signalling traffic for subscribers located in the home PLMN,
- the substantial reduction in signalling traffic between the visited PLMN and the home PLMN,
- no new network nodes are required,
- applicable to a wide range of protocol used for the transfer of data.

The disadvantages of the turbo-charger concept are:

- Connections are required from the access network to be fully meshed to all MSCs in the turbo-charger area.

9.14.2.1 Overview of the Turbo-Charger Concept

A Turbo-Charged network constitutes a network architecture designed to reduce mobility management costs and provide automatic load-sharing between MSC/VLRs.

The architectural philosophy is to equally divide the subscribers between the available MSC/VLRs, irrespective of their location. In the context of GSM, this could be achieved by placing a routing function (e.g. evolved STP) between the BSC and the pool of MSC/VLRs. The purpose of the routing function is to route A-interface messages to the MSC/VLR that is serving the mobile station. The solution requires the MS to store a discriminate that can be used to identify the serving MSC/VLR and for routing to be applied on this discriminate on the connection between the MSC/VLR and access network. A TMSI partitioning scheme could be utilised. This scheme allocates a sub-set of the TMSI range to each MSC/VLR, Figure X. The A-interface messages are then routed to the right MSC based on the TMSI. This could be done by a routing function external to the access network implying no access network modification (see figure x). If a TMSI partitioning scheme is used then new SIM cards are not required.

The temporary identity used for paging (TMSI) must be unique within all the MSCs in the turbocharger area. This implies that there must be a mechanism to ensure that this requirement is met for turbocharged MSCs (e.g. TMSI partitioning).

Two mechanism to provide load-sharing are envisaged, random load-sharing and dynamic load-sharing.

Random load-sharing requires the routing function to randomly assign a MSC/VLR to serve a particular mobile station when it first comes in to the network. Regardless of where the mobile is the same MSC/VLR will always serve it provided the mobile remains in the area served by all the turbocharged MSC/VLRs linked by the routing function.

In large metropolitan areas where subscribers are served by multiple MSC/VLRs, some MSC/VLRs may be very busy while others are not fully utilised. Dynamic load-sharing requires the implementation of an intelligent router. Since the routing function routes all A-interface traffic, it can participate in load-sharing and balancing based on the current loading of each MSC however linkage between MSC load and the routing algorithm would be required.

In the case of a Turbo-Charged network where the network is sub-divided into large regions, further optimisation can be achieved by adding the Super-Charger functionality.

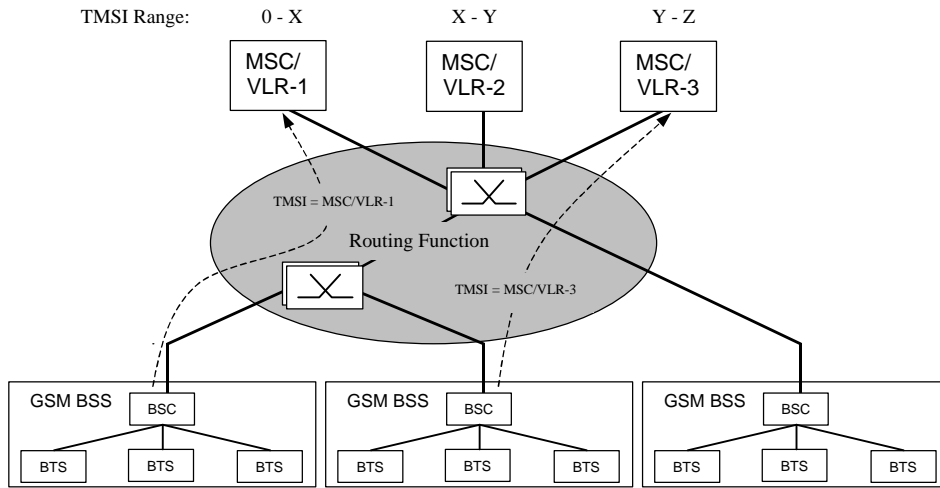

Figure 42: Example of GSM Turbo-Charger Network Architecture

In the context of UMTS, the routing function becomes a feature of the RNC, see **Error! Reference source not found.**

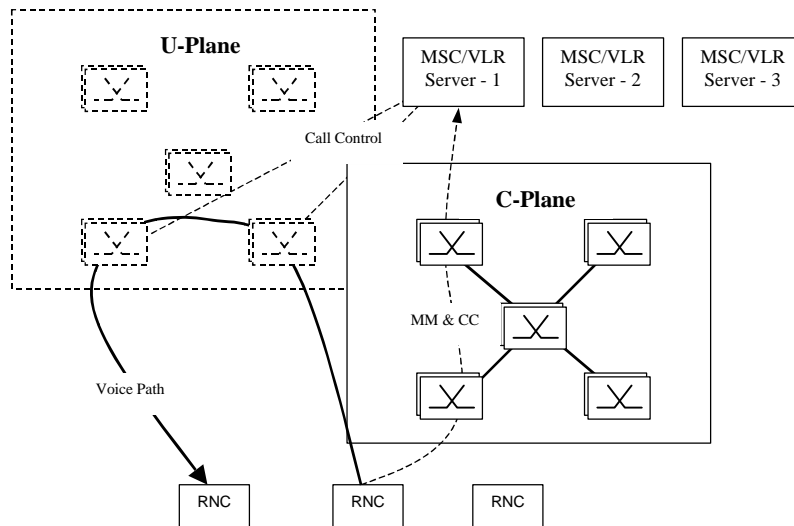

Figure 43: Example of UMTS Turbo-Charger Network Architecture

9.14.3 Relationship between GLR and TurboCharger

The GLR and TurboCharger are two independent schemes for reducing the amount of MAP traffic generated in UMTS networks.

- The GLR works by reducing traffic between PLMNs associated with Location Updates. This is achieved by "caching" the roaming subscriber's data in the visited network
- The TurboCharger works by eliminating the need to perform location updates. The same VLR can hold a subscriber's data for the duration of his attachment to the network.

A TurboCharged network requires that each MSC/VLR can physically connect to all RNCs. Therefore TurboCharging may be best suited to areas of the network characterised by dense geographic coverage. On the other hand, the GLR function is independent of the network density.

The network structure illustrated in **Error! Reference source not found.** shows that the GLR and a TurboCharged area within the same PLMN are independent. In fact, it shows benefits from using the two techniques in the same network. The Turbo-Charger reduces the location registration signals between the MSC/VLR and GLR:

- There is no new update location signal between MSC/VLR and GLR if roamer moves inside of the Region A.
- There is no new update location signal between GLR and HLR if roamer moves between regions.

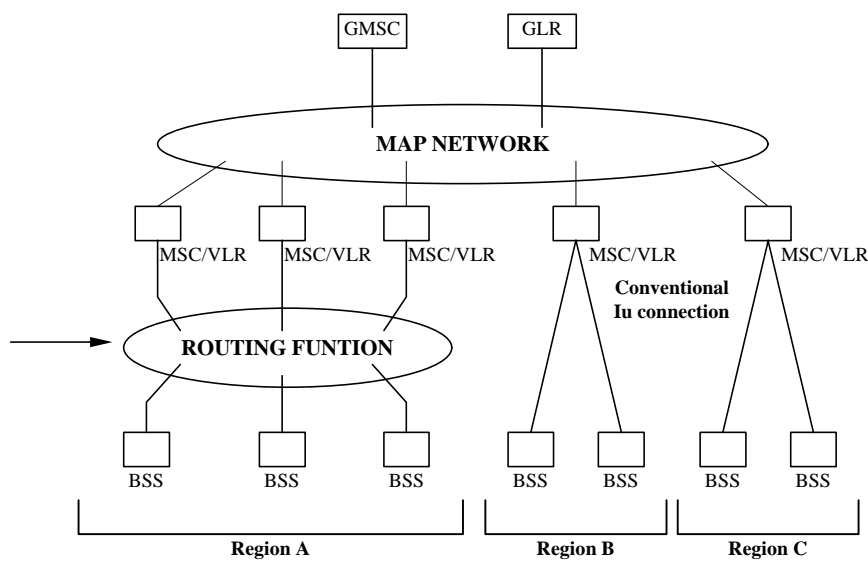

Figure 44.

9.15 Transcoder Control

In order to improve voice quality for mobile-to-mobile calls (MS-MS calls) in GSM Phase 2+ networks, Tandem Free Operation (TFO) using in-band signalling has been specified. The equivalent function in Japan's PDC (Personal Digital Cellular) network is known as Transcoder Bypass, which has been specified to make use of out-of-band signalling control (i.e. by the PDC-MAP protocol).

It is likely that UMTS terminals will support a wider range of codecs than is currently the case for GSM terminals. In the case of calls between UMTS terminals, codec negotiation will be needed to:

- match terminal capabilities during call establishment
- support supplementary services interactions such as with conference/Multi-party calling, ECT, CFNRy
- support changes in radio interface conditions.

This requires control of the transcoder unit in the UMTS Core Network during (and after) call establishment and handover. However, the inband signalling technique currently specified for GSM-TFO has limitations in this area. For example:

- **UMTS call setup;** the GSM-TFO mechanism is designed to support a limited set of codecs. Each time a new codec is introduced into UMTS the transcoder would need to be upgraded.
- **UMTS call in progress;** codec negotiation using the GSM-TFO mechanism would need complex in band signalling.

The different solutions to support the required functionality for transcoder control in UMTS need to be studied in detail. Signalling for codec negotiation and control may be achieved by:

- New control mechanisms between the mobile terminal and the network based transcoder (out of band and in-band solutions need to be studied).
- Revisions to ISUP signalling.
- Revisions to MAP signalling.
- Inband signalling mechanism developed for AMR

It is for further study what impact transcoder control has upon networks external to the PLMN.

9.16. Support of multimedia services

One of the most important requirements for UMTS is the capability of supporting multimedia services.

The following principles should guide and apply to the support of multimedia services in UMTS:

- Multimedia services in relation to UMTS should be standardised and handled according to emerging multimedia standards. SMG should not standardise multimedia services solely for UMTS networks. SMG should take advantage of existing and emerging main stream standards for multimedia, in reality defined outside of the UMTS.
- Multimedia applications according to such main stream standards should be *supported* (transported and handled) *efficiently* in the UMTS.
- Multimedia requirements on the UMTS should, as far as possible, explicitly be related to such multimedia application standards to be supported – rather than to generic statements or assumptions related to the architecture.
- The multimedia bearer capability requirements, incl. QoS, are expected to effect the core as well as the radio network.

Among others, two requirements for an efficient support for multimedia applications, which currently can not be achieved by GSM, are sufficient bandwidth allocation and flexibility of bearers.

- The bandwidth requirement relates to the transport technology used on (both the radio and network sides). In particular switching and transport capabilities within the network must be able to support, in an efficient and flexible way, air interface rates of at least up to 2 Mbit/s. It is unlikely that a 64 kbit/s based switching system will be able to do this in the most efficient manner.
- Separation of call control from connection and bearer control. This is an important requirement to satisfy the concept of Quality of Service for media components: a call/session may use various connections at any one particular instant (making use of one or several bearers). It should then be possible to add or remove bearers during such a call in order to cope with user needs or problems on the radio path. (Ref. ETS 22.01 Service Principles)

9.17. Support of services requiring variable bit rate

- If a number of applications use VBR data flows then packet transfer mode on the radio and network side has to be considered in order to make efficient use of resources.
- If packet transfer is allowed on the radio side, a finer degree of location management is/may be needed for radio resource optimisation (if only the LAI is used as in GSM, packets addressed to one single mobile terminal would need to be broadcasted over its entire Location Area; a new routing concept playing a similar role to the GPRS routing area is then needed). These additional Radio Resource/Mobility Management functions could be located in the Radio Access Domain, containing data strictly related to the access techniques that could be hidden from the serving network.

9.18 UMTS Simultaneous Mode.

Within GSM/GPRS Class A mobiles have been defined which support 'simultaneous operation of both GPRS and other GSM services'. UMTS is intended to enable users to access a variety of communications features including access to PSTN/ISDN services/features as well as IP capability. The UTRAN developments have a mechanism to support common 'pipe' over the radio interface (the RRC Connection). It is expected that multi-media and mixed media (PSTN/ISDN/IP communications) will play a large part of UMTS communications.

From this perspective it is essential for UMTS that from day 1 of network launch that mobile terminals can support both PSTN/ISDN services and features as well as IP simultaneously. Based upon this aspect 'Simultaneous mode' has been defined for UMTS communications. This definition can be applied to both network and mobile terminals.

Simultaneous mode is defined as the support of active parallel CS and PS communications.

The UE has simultaneous PS MM Connected and CS MM Connected states when in UE simultaneous mode.

Note: The support of 'Simultaneous mode' should not prevent the operation of mobile terminals in solely CS MM or PS MM connected mode. Simultaneous mode capable terminals should be supported in CS service and PS service only capable networks. Operators may wish to just use 3G_MSC and/or 3G_GSNs if required.

The impact of supporting 'Simultaneous mode' operation of the UE needs to be addressed within the UMTS System as a whole. In particular, the impacts upon the UE, radio, UTRAN and Core Network nodes need to be assessed.

10. Interoperability between GSM and UMTS

- Transparency [from a users perspective] of roaming and handover
- Re-use of existing subscription profiles

Note: This list is not exhaustive and is FFS.

This allows easier management and deployment of a new UMTS network.

UMTS is a system supporting handovers between GSM and UMTS in both directions. To support these handovers effectively, the following is required from a dual mode MS/UE supporting simultaneous ISDN/PSTN and packet service in GSM/UMTS:

Depending upon the solution adopted for GSM-UMTS handover, the MS/UE supporting simultaneous ISDN/PSTN and packet service may be required to perform appropriate update into CN depending on the activity of the UE once the handover between GSM and UMTS is completed. This update is needed to avoid any severe interruptions on the accessibility of packet services after the handover.

The nature of the update to be made after the handover in both direction, i.e., from GSM to UMTS and from UMTS to GSM, from MS/UE depends on the activity of the UE in the following way:

ISDN/PSTN connection: RA update only (if RA is changed)

Packet connection: LA and RA update (if RA and LA are changed)

Both ISDN/PSTN and packet connection: RA update only (if RA is changed)

If the RA, LA or both LA and RA are not changed the MS/UE behaviour is for further study

10.1 Circuit Switched Handover and Roaming Principles

Introduction of a UMTS Core Network necessitates the inter-connection with legacy systems to allow inter-PLMN roaming and handover.

For ease of convergence with the existing networks and the introduction of dual mode handsets, roaming and handover to/from UMTS should be performed in the simplest manner that requires as little change as possible to the legacy networks and standards, i.e. inter-MSC handover functionality.

These principles provide - from a user perspective - transparency of handover and roaming. In addition, operators providing UMTS services should also allow access to legacy networks using existing subscriber profiles and network interfaces.

Illustrated in Figure 45 shows the introduction of a UMTS Core Network for UMTS phase 1 network configuration. Notice that it leaves the current GSM specifications mainly untouched whereupon the UMTS core network acts towards the GSM MSC like a GSM MSC by providing for example MAP/E for handover purposes. Further, it should be observed that GSM subscriptions belong to the HLR whilst UMTS subscriptions exist in the HLR release 99..

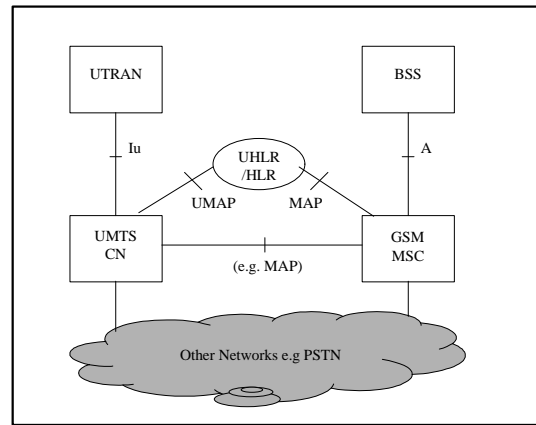

Figure xx. Inter-Operability between GSM and UMTS

Figure 45 Inter-Operability between GSM and UMTS

Note: No physical implementation should be taken from the figure. As a further note, no interworking functions are shown to ease clarity, but however should not be precluded.

From Figure 45 it can be seen that the information exchanged over the Iu must provide the necessary parameters to enable the core networks to communicate via for example the MAP interface for handover purposes.

Also note that from the above diagram, existing interfaces are used towards the HLR to allow for subscription management based on today's principles using the already defined user profile, providing seamless roaming between the 2nd generation system and UMTS.

The existing GSM handover procedures should be re-used to minimise the effects on existing GSM equipment (figure 1).

- The anchor concept in GSM for inter-MSC handover should be used for inter-system handover between UMTS and GSM.
- The signalling over the A-interface and over the MAP/E-interface should be the same as in GSM phase 2+ with possibly addition of some new or updated information elements in some messages.
- For the set up of the handover leg (user plane) standard ISUP/POTS should be used in line with the principles used in GSM.
- The control signalling over the Iu-interface at handover between UMTS and GSM should be based on the A-interface signalling at inter-MSC handover in GSM.
- The signalling over the Iu-interface at call set up to/from a dual mode UMTS/GSM mobile station, shall include GSM information elements needed for handover from UMTS to GSM.
In the corresponding way the signalling over the A-interface at call set up to/from a dual mode UMTS/GSM mobile shall include UMTS elements needed for handover from GSM to UMTS.
The data are needed to initiate the handover towards the new BSS/RNC.
- A target cell based on CGI is sent to the MSC from UTRAN at handover from UMTS to GSM. The CGI points out the target MSC and target BSC.
The target "cell" identifier for UMTS at handover in the direction GSM to UMTS is for further study.

10.2 Packet Switched Handover and Roaming Principles

The introduction of a UMTS core Network as described in section 11.1 illustrates the requirement for inter-connection with the legacy GSM system to allow inter-PLMN roaming and handover.

Even though there is no current GPRS deployment, the operator may decide to deploy a GPRS network prior to the deployment of a UMTS network. Therefore, the introduction of a UMTS Core Network may require to be inter-connected to the legacy packet network.

As in the circuit switched case, roaming and handover to/from UMTS should be performed in the simplest manner that requires as little change as possible to the GPRS network and standards, i.e. inter-GSN handover functionality. In addition, access is provided to the GPRS network using the existing subscriber profiles and current network interfaces.

A similar figure to Figure 45 is illustrated in Figure 46. Notice that it also leaves the current GPRS specifications mainly untouched whereupon the UMTS core network acts towards the GSN like a GSN by providing for example Gn. Further, it should be observed that GPRS subscriptions belong to the HLR whilst UMTS subscriptions exist in the HLR release 99.

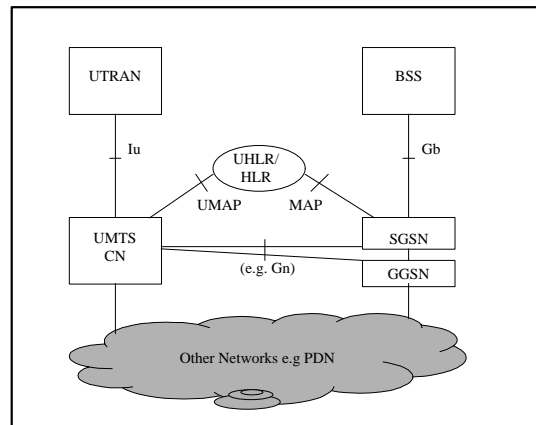

Figure xx. Inter-Operability between GSNs and UMTS

Figure 46 Inter-Operability between GSNs and UMTS

Note: No physical implementation should be taken from Figure 46. As a further note, no interworking functions are shown to ease clarity, but however should not be precluded.

From Figure 46 it can be seen that to provide inter-working between legacy packet switched and UMTS packet switched services, the information exchanged over the Iu must provide the necessary parameters to enable the core networks to communicate via for example the Gn interface for handover purposes.

Also note that from the above diagram, the same principles are used as in the circuit switched services to provide seamless roaming.

10.2.1 Implications

- The active PDP context resides in the same GGSN even after a handover between GSM and UMTS (both directions). This corresponds in principle to the anchor concept on the circuit switched side, but note that whereas packet sessions are long lived, the anchor MSC remains only for the duration of a CS call (typically much shorter than a packet session).
- Assuming an internal structure in UMTS CN that contains logical GGSN and SGSN nodes, the signalling over the inter-system GGSN-SGSN interface should be a joint evolution of Gn for the GSM system and UMTS. I.e., when Gn evolves in the sequence of GSM releases, Gn should include any new or updated information necessary for interoperation.
- The corresponding SGSN-SGSN inter-system interface (also Gn) should also be evolved together. However, in this case the changes relative to the current GPRS release may possibly be more profound.

11 Network Migration And Evolution

The installed base of GSM networks will be very comprehensive at the time of the UMTS roll out. These GSM networks will co-operate very closely with and in many cases be partly integrated into the overall UMTS network. Thus network migration and evolution is a very fundamental aspect to consider when standardising UMTS.

11.1 Network Migration Scenarios

A number of principally different network migration scenarios can be envisioned, e.g.:

- GSM to GSM release 99 (GSM operator with no UMTS licence and no UMTS roaming/handover agreements).
- GSM to GSM release 99 with support for dual mode 'UMTS visitors' (GSM operator with no UMTS licence but with UMTS roaming/handover agreements).
- GSM to GSM/UMTS (GSM operator with a UMTS licence).
- UMTS only PLMN (new UMTS operator with GSM roaming/handover agreements). This scenario is more a matter of network 'compatibility' rather than network migration.

A basic assumption is that the provision of UMTS services in most cases will start, from a radio coverage point of view, within 'islands in a sea of GSM BSS'.

11.2 network migration and evolution requirements

- 1) The UMTS standard shall consider all aspects of network migration and shall describe the migration process from GSM release 98 to UMTS/GSM release 99, including the aspect of partly updated networks and its consequences on end-user services etc.
- 2) While fulfilling the SMG1 requirements the UMTS standard shall aim at minimising the impact on the existing GSM networks delivering only GSM. It is recognised that GSM/GPRS standards will need developments for UMTS however these should not adversely impact the networks that offer GSM only.
- 3) It shall be possible to perform the network migration process of a PLMN independently of co-operating PLMNs.
- 4) It shall be possible to gradually migrate a PLMN, i.e. the UMTS standard shall allow network elements compliant with different GSM releases to co-exist within a PLMN.
- 5) The impact on end-user service level for partly updated PLMN(s) is FFS.
- 6) Internetworking within a PLMN as well as between different PLMNs shall allow operators to utilise current backbone networks (dedicated for GSM traffic only or carrying non-mobile traffic as well according to non-PLMN specific standards).
- 7) A GSM/UMTS mobile terminal shall be reachable from an external network (PSTN/ISDN, IP, X.25) regardless of the mobile terminal being served by BSS or UTRAN.
- 8) A terminal in an external network, as well as the external networks themselves, shall not need to know if the GSM/UMTS mobile terminal is served by BSS or UTRAN.
- 9) The user equipment shall not need to change the E.164 or IP address at handover between UTRAN and BSS.

12 Protocol Architecture

12.1 I_U Signalling Bearer Requirements for IP Domain

12.1.1 Connectionless and Connection Oriented Services

Connection-oriented and connection-less I_U Signalling Bearers are required.

12.1.2 Dynamic Bandwidth Allocation

The I_U Signalling Bearer shall support rapid and flexible allocation and de-allocation of I_U transport resources.

12.1.3 Reliable Transfer

The I_U Signalling Bearer shall provide reliable delivery of signalling data.

12.1.4 Flow Control

The I_U Signalling Bearer shall provide throttling mechanisms to adapt to intermittent congestion in the UTRAN or Core Network.

12.1.5 Redundancy and Load Sharing

To handle detected failures and signalling data congestion, the I_U Signalling Bearer shall be capable of dynamically routing over alternate routes that minimise delay. If the delay metrics over alternative routes are identical, the I_U Signalling Bearer shall be capable of spreading traffic over the identical paths, thus performing load sharing.

12.1.6 Large Pdu Size

To support large transactions, it is important for the I_U Signalling Bearer to provide a Signalling Data Unit size, large enough to allow for all signalling messages to be transferred without fragmentation.

12.1.7 Signalling Bearer Management

To support supervision of I_U Signalling Bearers, mechanisms for managing I_U Signalling Bearers shall be used to provide status information to the RANAP for individual UE(s). The signalling bearer shall also maintain a consistent UE Activation State in the access and the core network.

12.1.8 Transport Media Independence

The I_U Signalling Bearer shall be independent of the underlying transport media (e.g. ATM).

12.2

History

Document history		
Date	Status	Comment
21 May 1997	Version 0.0.1	Creation of Document with output from SMG 3 SA Meeting (Sophia Antipolis, May 97)
07 July 1997	Version 0.0.2	SMG 3 SA meeting output version (Sophia Antipolis, 04.07.97)
25 Sept 1997	Version 0.0.3	SMG3 SA meeting output version (Paris August 97) Application of new template according to ETSI rules.
06 Nov 1997	Version 0.1.0	SMG3 SA meeting output version (Milan Oct 97)
21 Nov 1997	Version 0.2.0	SMG3 SA Meeting output version (Kista, Nov 97) Inclusion of Tdocs 97s380,97s385 and 97s394
09 Mar 1998	Version 0.3.0	SMG3 SA Meeting output version (Malmo Jan 98) Inclusion of Tdoc 98s080 and deletion of 2 nd Bullet point of section 7.4 as agreed in the minutes re: 98s075
12 Mar 1998	Version 0.3.1	Corrected V. 0.3.0
15 April 1998	Version 0.4.0	SMG3 SA Meeting output version (Bad Aibling March 98) Inclusion of Tdoc 98S133
15 May 1998	Version 0.5.0	SMG3 SA Meeting output version (Lisbon ,May 98) Inclusion of Tdoc 98S311 and Tdoc 98S314
18 May 1998	Version 0.5.5	Preliminary restructured version without new scenarios
26 May 1998	Version 0.5.6	New Scenarios Included
29 July 1998	Version 0.6.0	SMG12 Meeting Output Version (Chicago, June 1998) Inclusion of Tdoc 98S353, 98S325, 98S334 modified,98S368 modified, 98S354, 98S427 modified, 98S361 modified, 98S356, 98S359. (*Modified* implies version approved via email exploder) - Update of all figure numbers, with minor adjustments in text to take this into account.

25 th August 1998	Version 0.7.0	<p>SMG12 Meeting output version (Sophia Antipolis, August 1998).</p> <p>Inclusion of new scenarios Tdocs 98S504, 98S509, 98S585, 98S606, 98S607, 98S645, 98S648, 98S649.</p> <p>Removal of phasing headers to the scenario chapters. (Change bars not used on chapter numbering to ease reading)</p> <p>Inclusion of Tdoc658 in section 8.0 (See minutes)</p> <p>Inclusion of Tdocs 503, 511, 531(part) and 584</p> <p>New chapter 10 as proposed on Tdoc630</p> <p>Inclusion of details on VHE - Tdoc 513,540, 673</p>
10 th October 1998	Version 1.0.0 Draft	<p>SMG12 Meeting output version (Rome, Sept 1998).</p> <p>Inclusion of Tdocs 757, 759, 841, 728, 835, 726, 836, 815, 840, 803,851, 839, 745</p> <p>Renumbering of scenarios and chapter numbers (not shown with revisions for ease of reading)</p>
13 th October 1998	Version 1.0.0 New Draft	<p>Inclusion of Tdoc 98S781, Deletion of scenario 2 (formerly 3) and subsequent renumbering. Note on scenario 5 (formerly scenario 9)</p>
3 rd November 1998	Version 1.1.0	<p>SMG12 Meeting output version (Montreux, Oct 1998).</p> <p>Inclusion according to the meeting minutes of Tdocs 891, 925, 930, 934, 935, 936, 942v2, 946, (Tdocs 916 and 917 not included due to no soft copy)</p>
31 st December 1998	Version 1.2.0	<p>SMG12 Meeting Output Version (Castle Coombe, Nov 1998)</p> <p>Inclusion according to the meeting minutes of Tdocs 1073, 1124, 994, 1084, 1006, 1012, 1121.</p> <p>Deletion of scenario 5.</p>

12 th January 1999	Version 1.3.0	<p>SMG12 Meeting Output Version (Heathrow, Jan 99)</p> <p>Relocation of scenarios (Previously Chapter 10, change bars not used) to new Appendix.</p> <p>Deletion of chapter on GSM capabilities (Previously Chapter 7, change bars not used)</p> <p>Removal of chapter 8,5 VHE section (Section 8.5) – Transferred to Open Service Document (Change bars not used)</p> <p>Removal of chapter 11 Protocol Architecture chapter (previously chapter 11 – empty chapter, change bars not used)</p> <p>Inclusion of the following Tdocs from the Heathrow meeting 96,19,20,80,81,42,82,46,95,74,75,84,60,61,93,102,99,68,76,100.</p>
29 th January 1999	Version 1.4.0	<p>SMG12 Meeting Output Version (Walnut Creek, Jan 99)</p> <p>Inclusion of the following Tdocs according to the minutes of the above meeting. 226, 250, 241, 237, 186, 239, 259, 198, 188, 258, 145, 244, 233, 253, 211, 206</p>
7 th February 1999	Version 1.5.0	<p>SMG12 Meeting Output Version (Stockholm, Feb 99)</p> <p>Change bars have not been used where items have been simply moved.</p>
8 th April 1999	Version 1.6.0	<p><u>3GPP – WG2 meeting output version (Nynashamn, Mar 99)</u></p> <p><u>Removal of appendices</u> <u>Bran section moved to correct location</u></p> <p><u>Inclusion of Tdocs 129, 134,123, 95, 116, 143, 69</u></p>
13 th April 1999	Version 1.6.1	<p><u>Correction of miscellaneous errors made by the editor including taking into account C-99-345 from the February Stockholm meeting.</u></p>

23.20 Appendices

The appendices have been moved to another document – (not identified at present)

