

**3GPP TSG_CN
Plenary Meeting #9, Oahu, Hawaii
20th – 22nd September 2000.**

Tdoc NP-000550

Source: TSG_N WG 4

Title: Editorial CRs to R99 Work Item Technical Enhancements and Improvements (TEI)

Agenda item:

Document for: APPROVAL

Introduction:

This document contains 13 Editorial CRs on R99 Work Item TEI, that have been agreed by TSG_N WG4, and is forwarded to TSG_N Plenary meeting #9 for approval.

SM	TDoc	SPEC	CR	REV	PHAS	VERS	SUBJECT	CAT
CN9	N4-000429	23.011	002		R99	3.0.1	SDL refresh	D
CN9	N4-000564	23.018	059		R99	3.5.0	Modification to procedure obtain routeing address	D
CN9	N4-000430	23.082	008		R99	3.2.0	SDL refresh	D
CN9	N4-000431	23.083	004		R99	3.1.0	SDL refresh	D
CN9	N4-000432	23.084	002		R99	3.1.0	SDL refresh	D
CN9	N4-000433	23.085	001		R99	3.0.1	SDL refresh	D
CN9	N4-000434	23.086	001		R99	3.0.1	SDL refresh	D
CN9	N4-000435	23.087	001		R99	3.0.1	SDL refresh	D
CN9	N4-000436	23.088	002		R99	3.1.0	SDL refresh	D
CN9	N4-000437	23.090	002		R99	3.1.0	SDL refresh	D
CN9	N4-000438	23.091	002		R99	3.1.0	SDL refresh	D
CN9	N4-000748	29.002	179	1	R99	3.5.1	Correction to MSC-A handover SDLs	D
CN9	N4-000749	29.002	185		R99	3.5.1	Correction to MSC-A handover SDLs	D

CHANGE REQUEST		Please see embedded help file at the bottom of this page for instructions on how to fill in this form correctly.	
23.011 CR 002		Current Version: 3.0.1	
GSM (AA.BB) or 3G (AA.BBB) specification number ↑		↑ CR number as allocated by MCC support team	
For submission to: CN#09	for approval <input checked="" type="checkbox"/>	strategic <input type="checkbox"/>	(for SMG use only)
<i>list expected approval meeting # here</i> ↑	for information <input type="checkbox"/>	non-strategic <input checked="" type="checkbox"/>	

Form: CR cover sheet, version 2 for 3GPP and SMG The latest version of this form is available from: <ftp://ftp.3gpp.org/Information/CR-Form-v2.doc>

Proposed change affects: (U)SIM ME UTRAN / Radio Core Network
(at least one should be marked with an X)

Source: N4 **Date:** 2000-06-26

Subject: SDL refresh

Work item: TEI

Category:	F Correction <input type="checkbox"/> A Corresponds to a correction in an earlier release <input type="checkbox"/> B Addition of feature <input type="checkbox"/> C Functional modification of feature <input type="checkbox"/> D Editorial modification <input checked="" type="checkbox"/>	Release:	Phase 2 <input type="checkbox"/> Release 96 <input type="checkbox"/> Release 97 <input type="checkbox"/> Release 98 <input type="checkbox"/> Release 99 <input checked="" type="checkbox"/> Release 00 <input type="checkbox"/>
(only one category Shall be marked With an X)			

Reason for change: The SDL diagrams in this document have been replaced, without any semantic changes due to the following reasons:

- In the previous version, the diagrams contained nothing but garbage when viewed on-screen.
- Some of the diagrams were, if not impossible, very hard to print.
- A binary version of the SDL diagrams, suitable for standard tools, is needed to assure a qualitative handling of the diagrams in the future. Telelogic Tau SDL Suite (formerly known as SDT) versions of the diagrams have been created and made available, providing a new fresh base for future changes. For obvious reasons, the binary version, to be regarded as the source, should be mirrored in the document. Therefore, the diagrams replacing the previous versions are printouts of the binary versions.

Clauses affected: All figures in the document, containing an SDL diagram.

Other specs Affected:	Other 3G core specifications <input type="checkbox"/> Other GSM core specifications <input type="checkbox"/> MS test specifications <input type="checkbox"/> BSS test specifications <input type="checkbox"/> O&M specifications <input type="checkbox"/>	→ List of CRs: → List of CRs: → List of CRs: → List of CRs: → List of CRs:	
------------------------------	---	--	--

Other comments: ETSI plans to make the binary versions of the SDL diagrams available on the 3GPP website.

2.3 Exceptional handling of basic service codes

When an individual teleservice code or bearer service code is sent by an MS instead of an elementary basic service group the network shall treat such a request as a request for the corresponding elementary basic service group.

The response to such a request shall include the elementary basic service group code of this basic service code if this is required by the protocol or application.

Process SS_REQUEST_WITH_BS_GROUP

311_211(1)

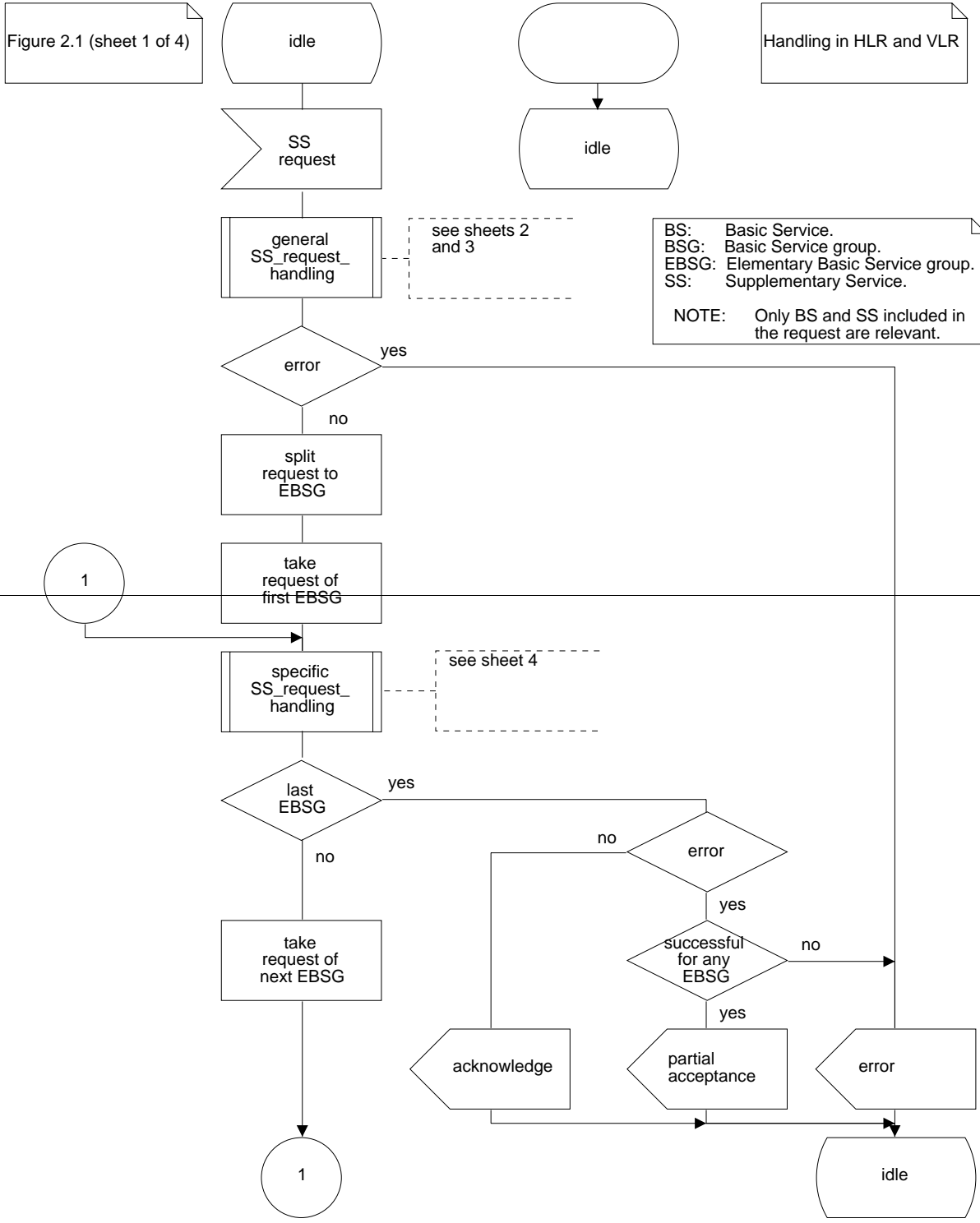

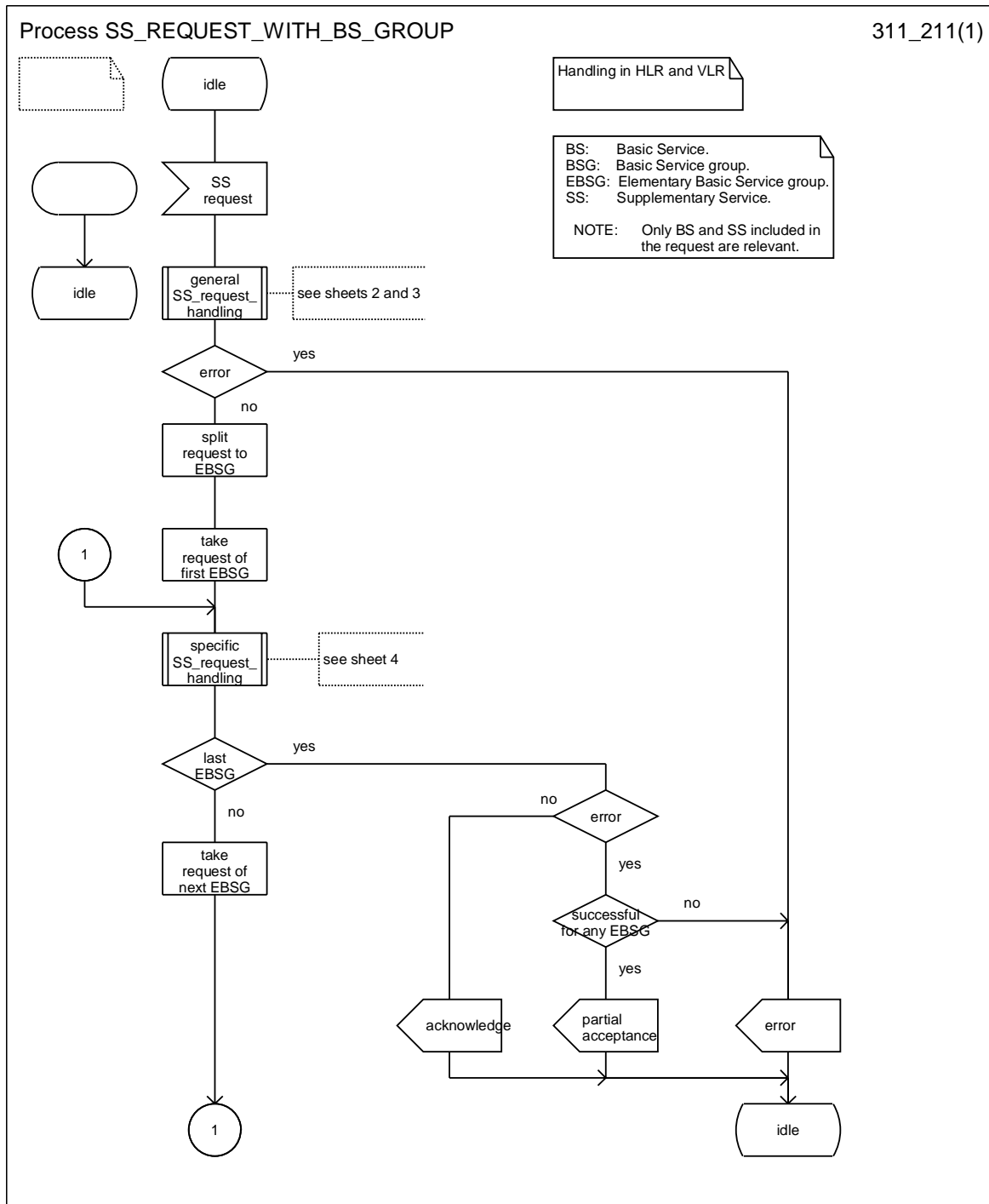
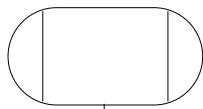

Figure 2.1 (sheet 1 of 4): Handling of call independent SS procedures with respect to basic service groups

Procedure general_SS_request_handling

311_212(2)

Figure 2.1 (sheet 2 of 4)



BS: Basic Service.
BSG: Basic Service Group.
SS: Supplementary Service.

Handling of the entire request

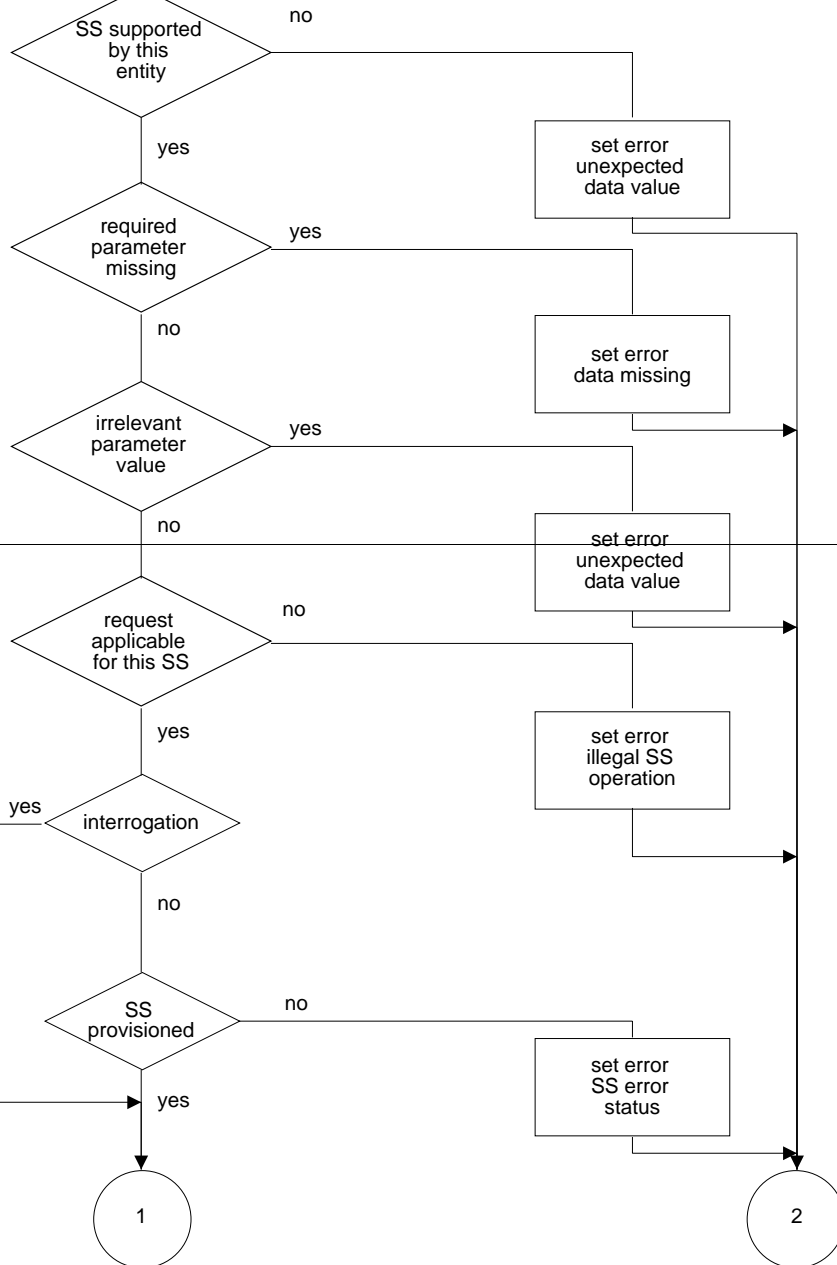

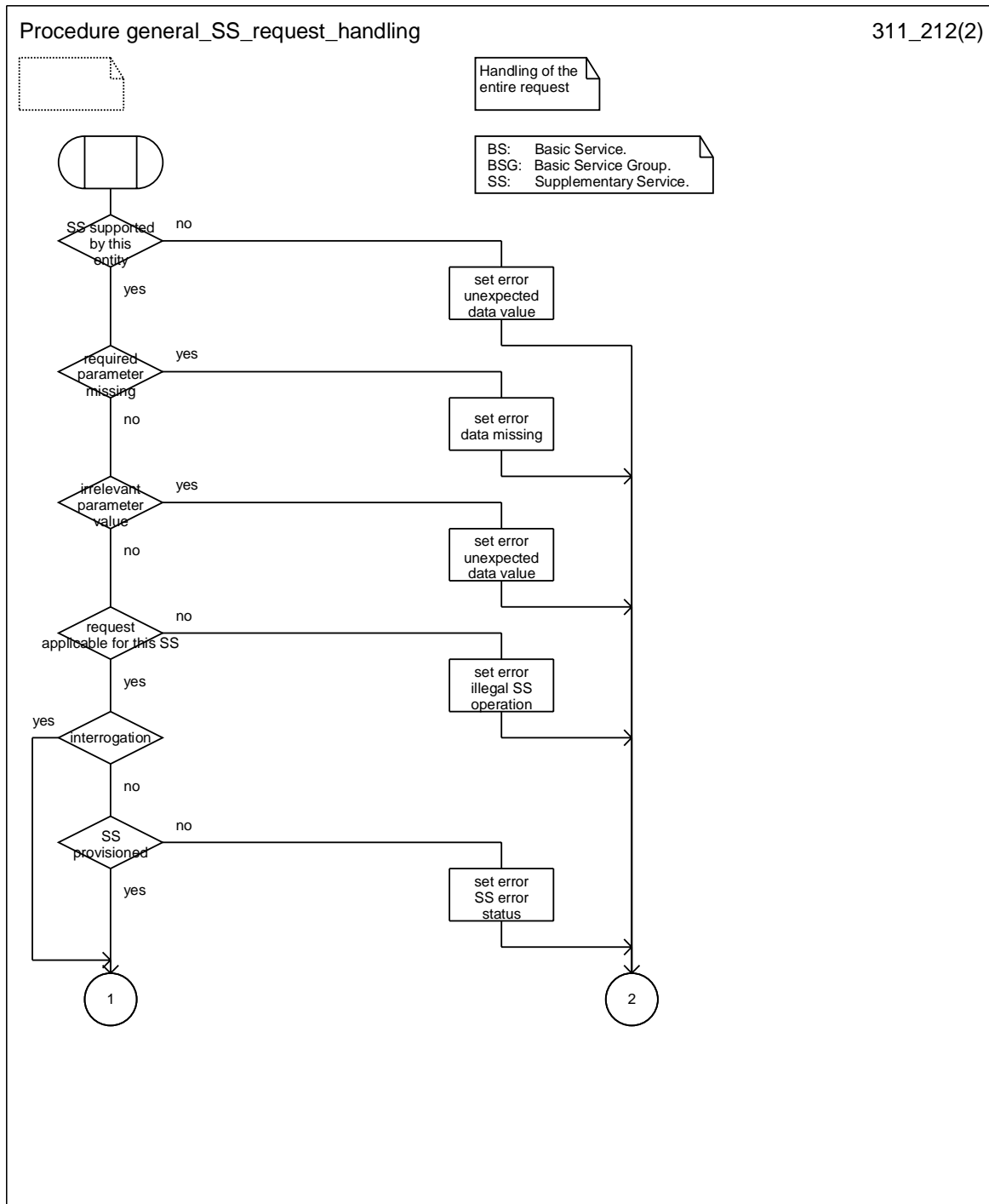
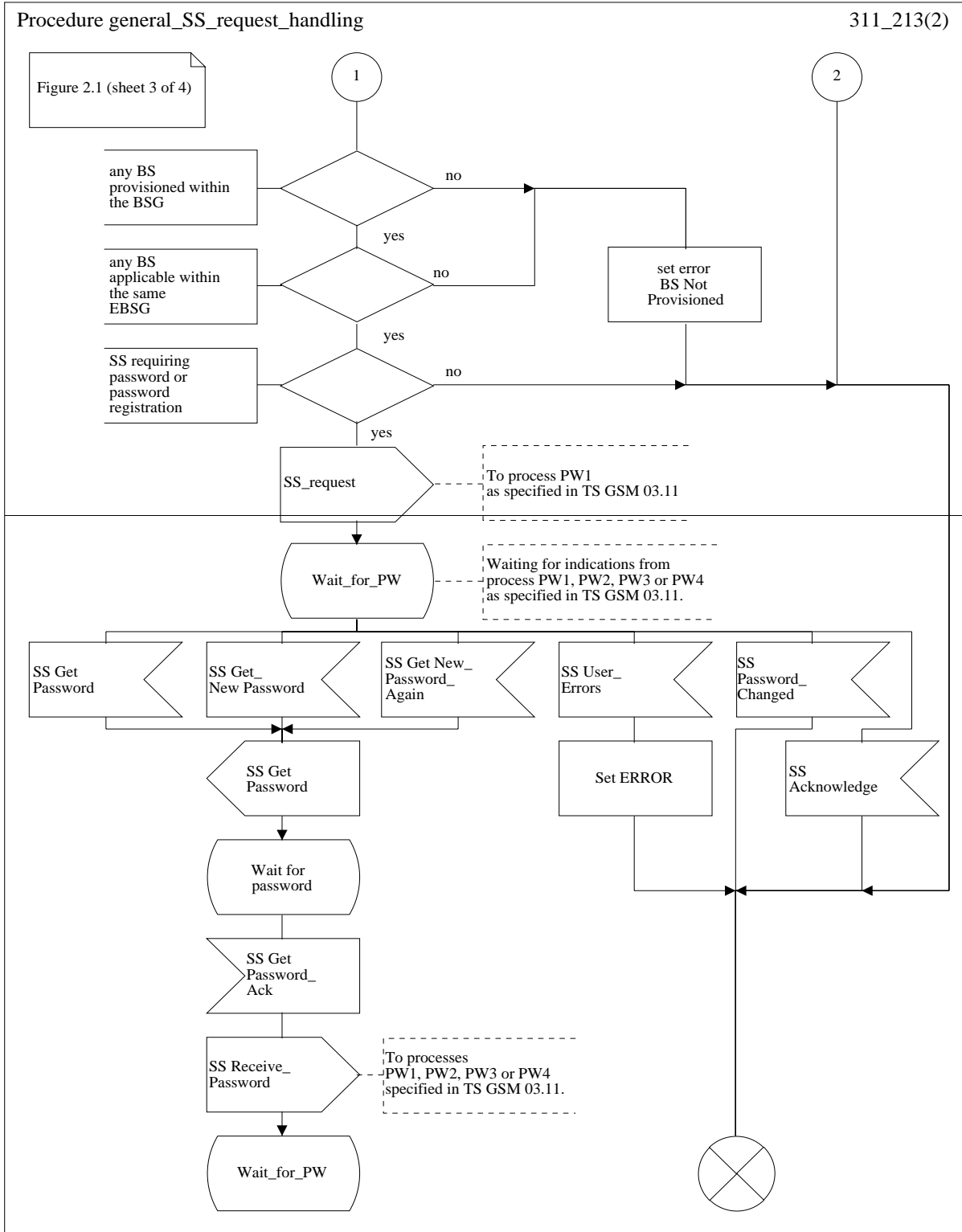

Figure 2.1 (sheet 2 of 4): Handling of call independent SS procedures with respect to basic service groups



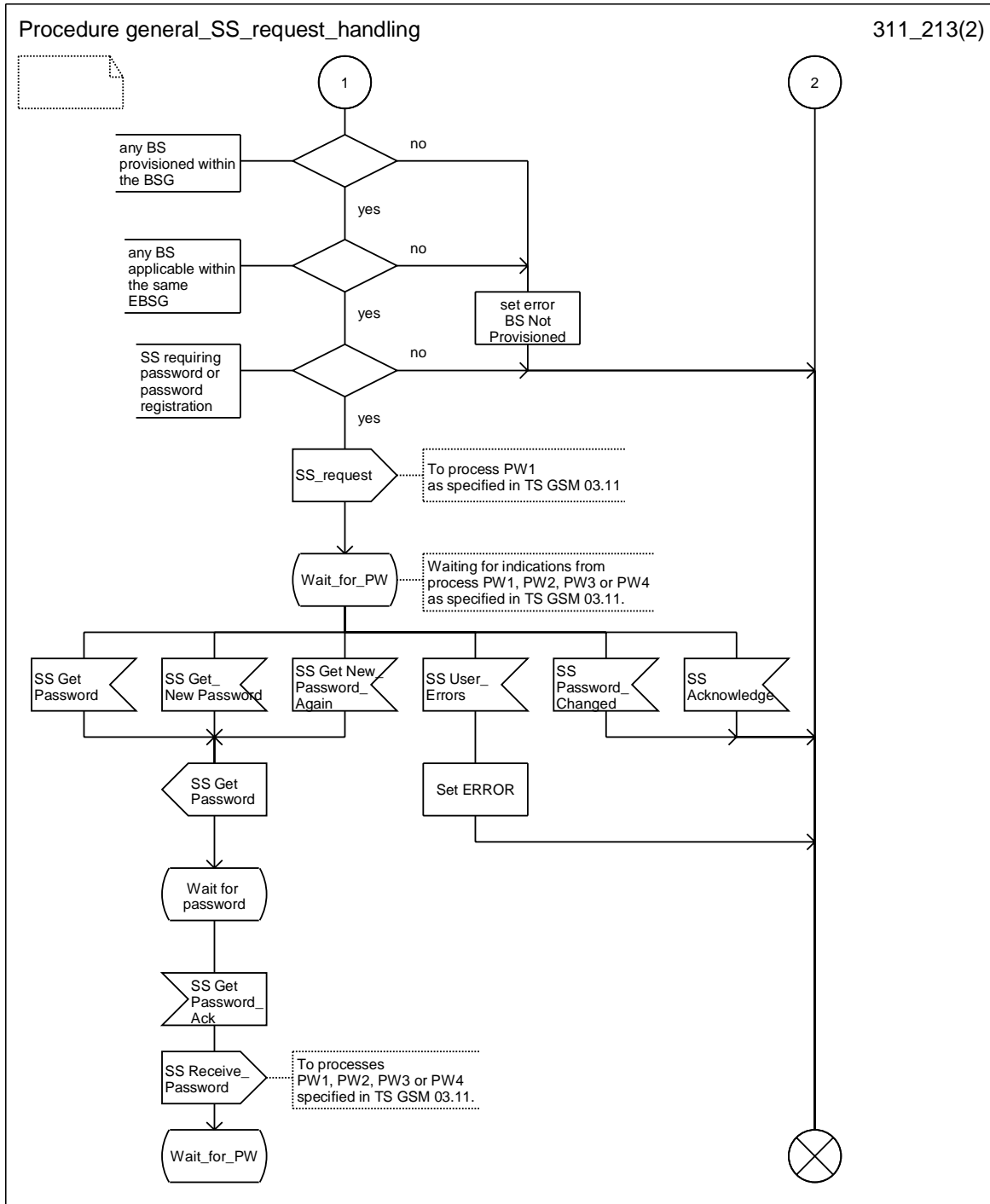

Figure 2.1 (sheet 3 of 4): Handling of call independent SS procedures with respect to basic service groups

Procedure specific_SS_request_handling

311_214(1)

Figure 2.1 (sheet 4 of 4)

Handling of elementary BS groups

BS: Basic Service
EBSG: Elementary Basic Service Group
SS: Supplementary Service

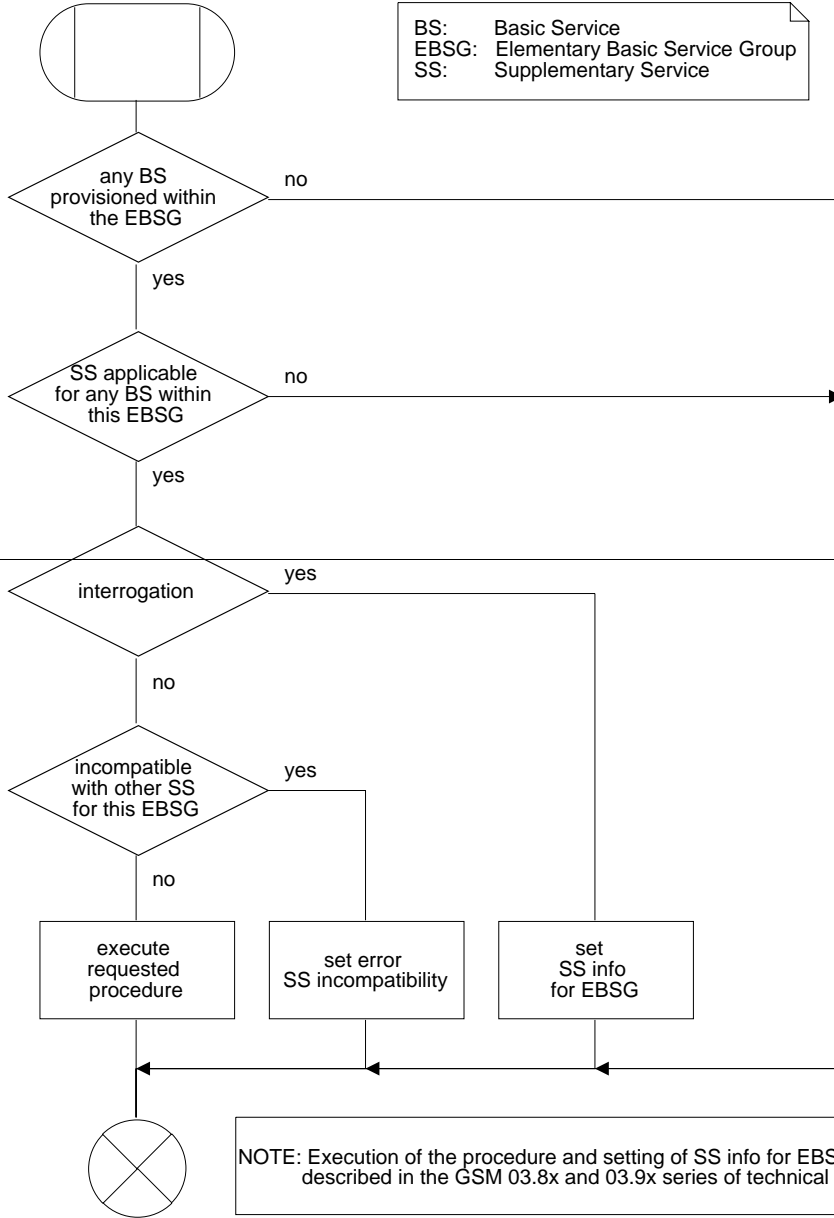

NOTE: Execution of the procedure and setting of SS info for EBSGs is described in the GSM 03.8x and 03.9x series of technical specifications.

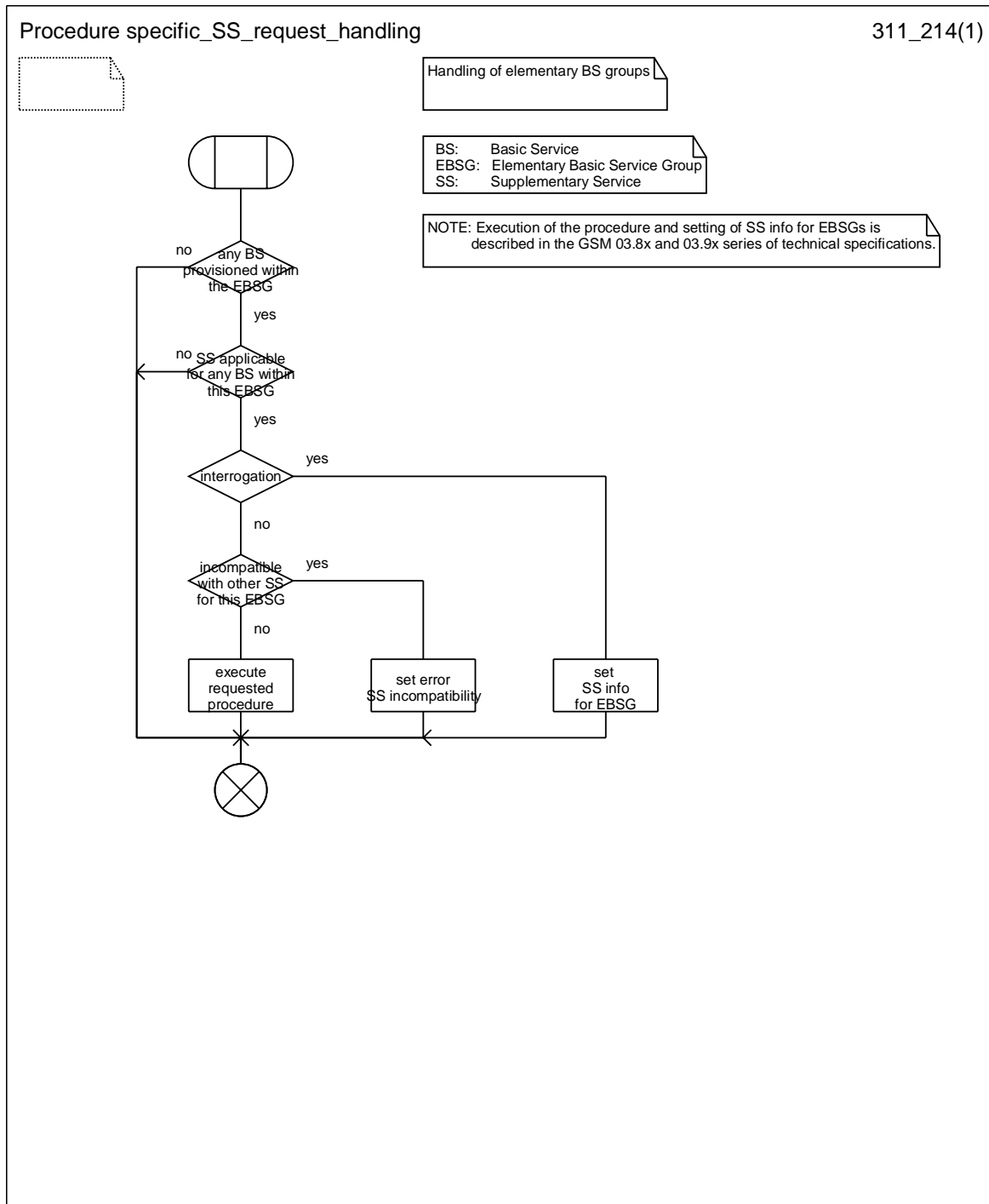

Figure 2.1 (sheet 4 of 4): Handling of call independent SS procedures with respect to basic service groups

3 Password handling

3.1 General

Some supplementary services can be subscribed with the option "control of supplementary service by subscriber using password" as described in the corresponding GSM 03.8x and 03.9x-series of technical specifications. These services are referenced in the following as protected supplementary services.

The password is stored in the HLR only.

It has to be memorised by the network, if a wrong password has been used. Therefore, the HLR stores the value of the Wrong Password Attempts counter (WPA).

If a password check is done with an incorrect password, the WPA is incremented by one. If a password check is passed, WPA is set to zero. If WPA exceeds the value three, the subscription option "control of supplementary service" is set to "by the service provider". This makes registration of password and activation or deactivation of protected supplementary services impossible (see GSM 02.04).

When the service provider registers a password, the WPA is set to zero.

When an attempt to perform an operation requiring a password is received by the network, the network has to check whether the requesting subscriber has subscribed to the option "control of supplementary service by subscriber using password". This is shown in figure 3.1 (function PW1).

If this option has the value "by the service provider" the WPA has to be checked. When WPA exceeds three, then more than three attempts with a wrong password have been made and the appropriate message will be sent to the user. If the value of WPA is less than or equal to three, then the subscriber has not subscribed to "control of supplementary service by subscriber using password".

When a password is supplied, it has to be checked, whether it is identical to the one stored. If this applies, then WPA is reset to zero. Otherwise WPA is incremented by one and dependent of the value of the counter, the network shall request the password again, or shall send an error message and update the subscription option as shown in figure 3.2 (function PW2).

After the input of a wrong password more than three consecutive times, the only possibility to reset the Wrong Password Attempts counter (WPA) is, to register a new password by the service provider.

Figures 3.3 and 3.4 show the procedures executed by the network in order to check the format (function PW3) and to check the new password (function PW4).

Process PW1

311_31(1)

Figure 3.1

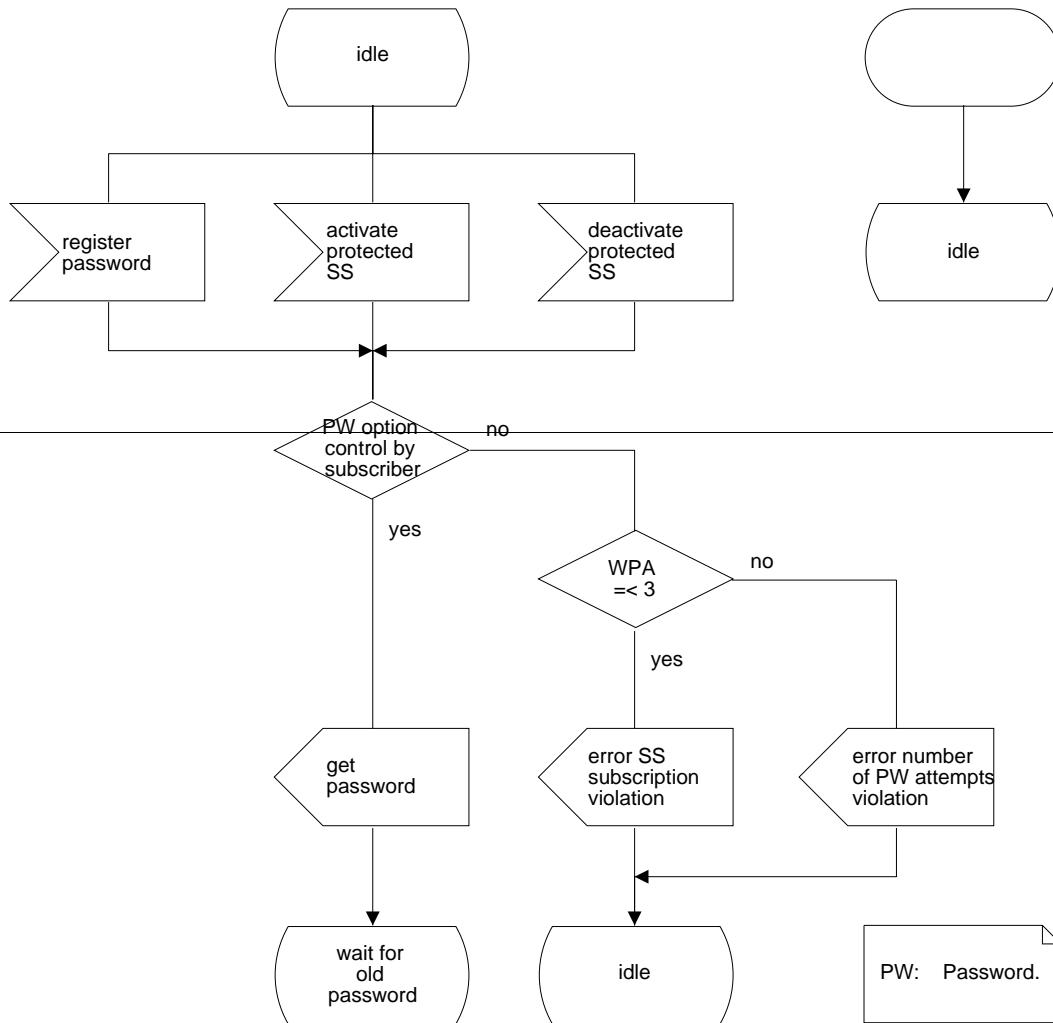

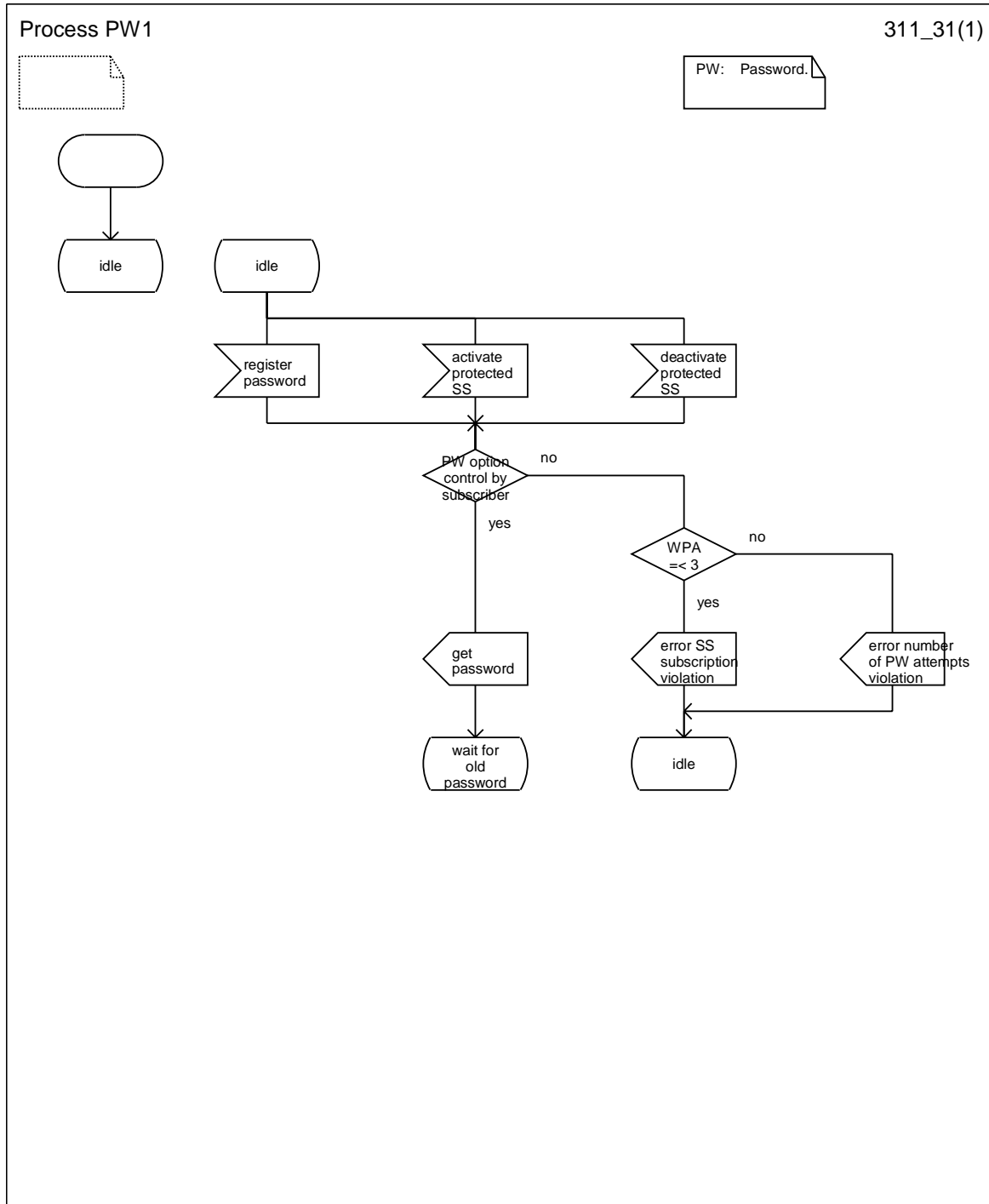
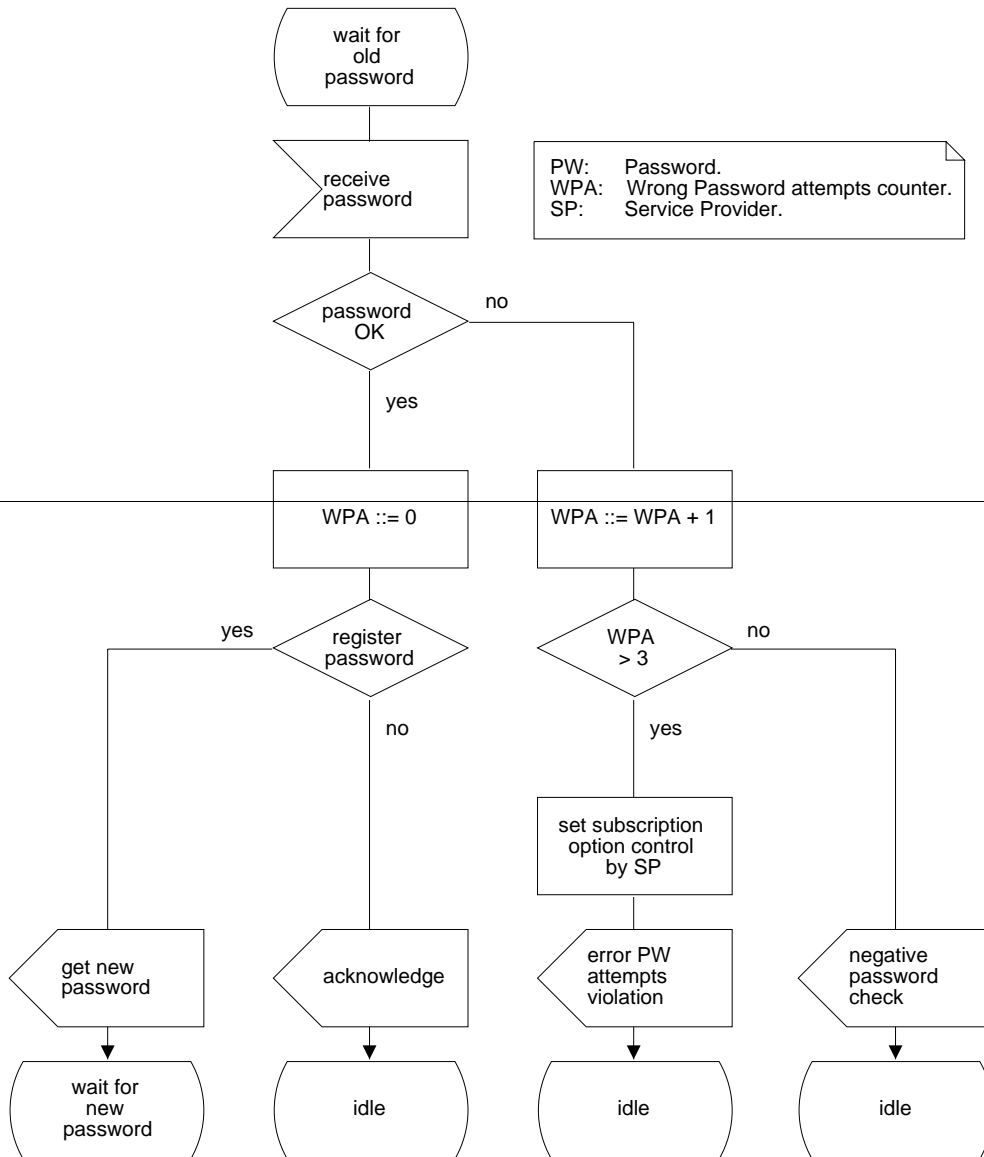

Figure 3.1: PW1; Check of subscription option (HLR)

Process PW2

311_32(1)

Figure 3.2



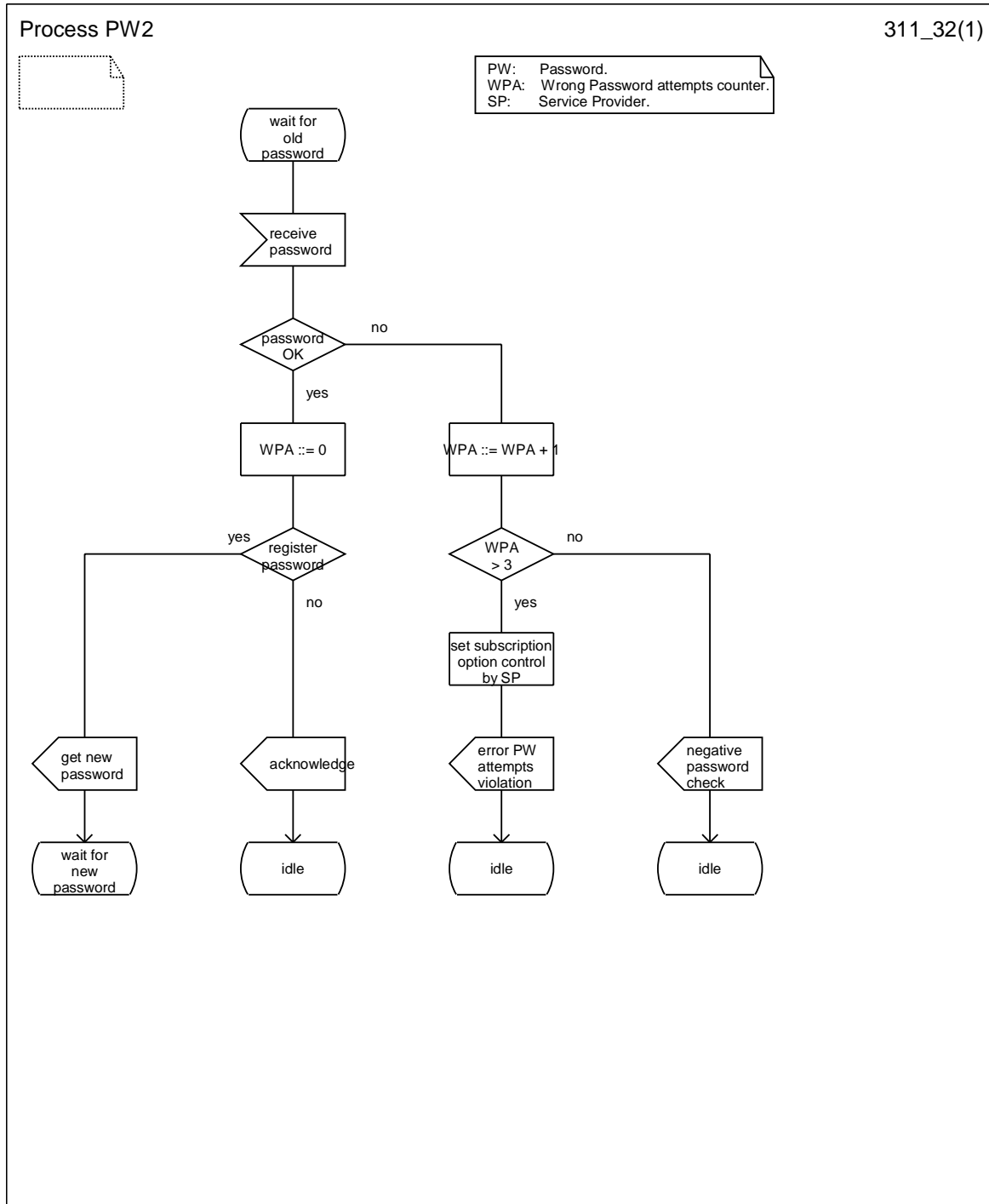
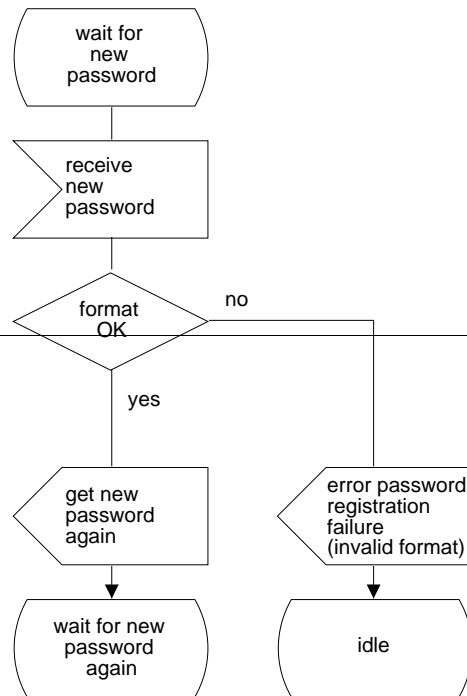

Figure 3.2: PW2; Check of password input (HLR)

Process PW3

311_33(1)

Figure 3.3



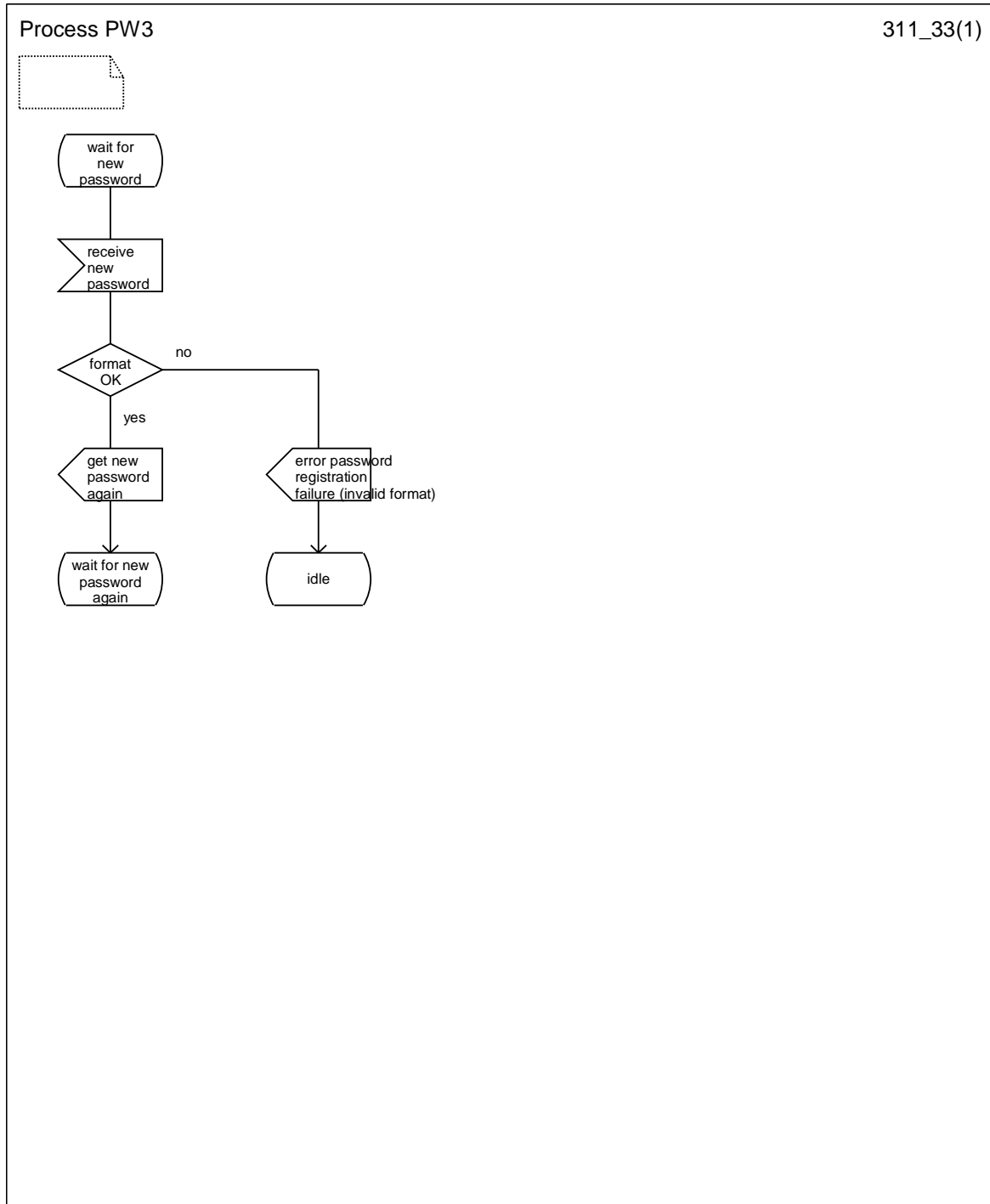
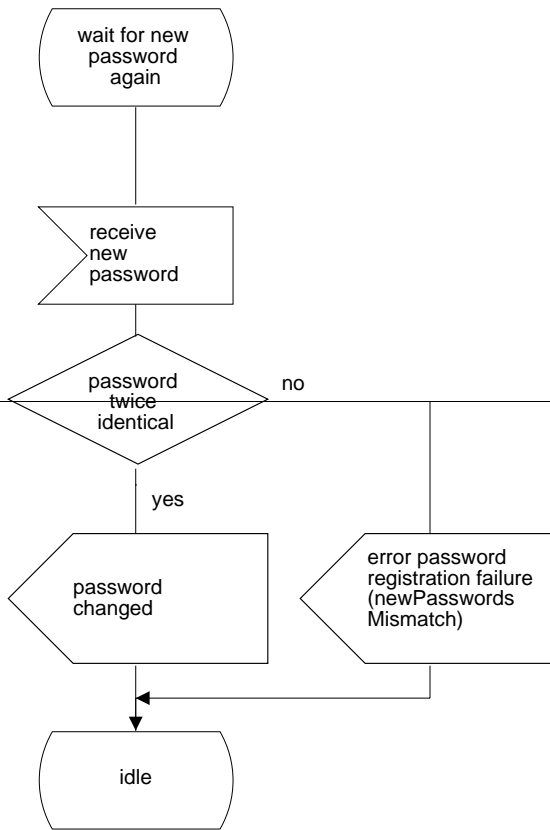

Figure 3.3: PW3; Format check (HLR)

Process PW4

311_34(1)

Figure 3.4



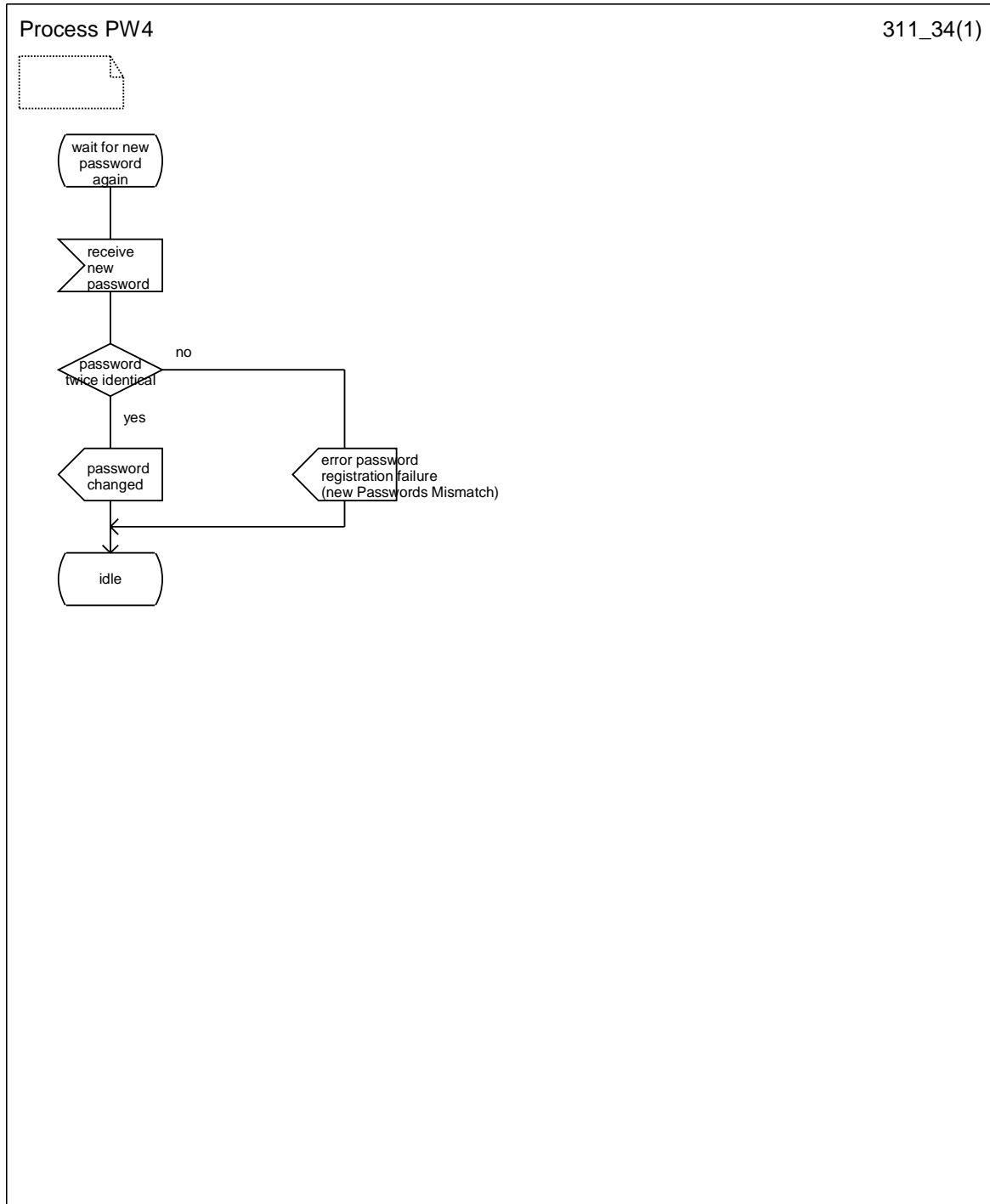

Figure 3.4: PW4; Check of new password (HLR)

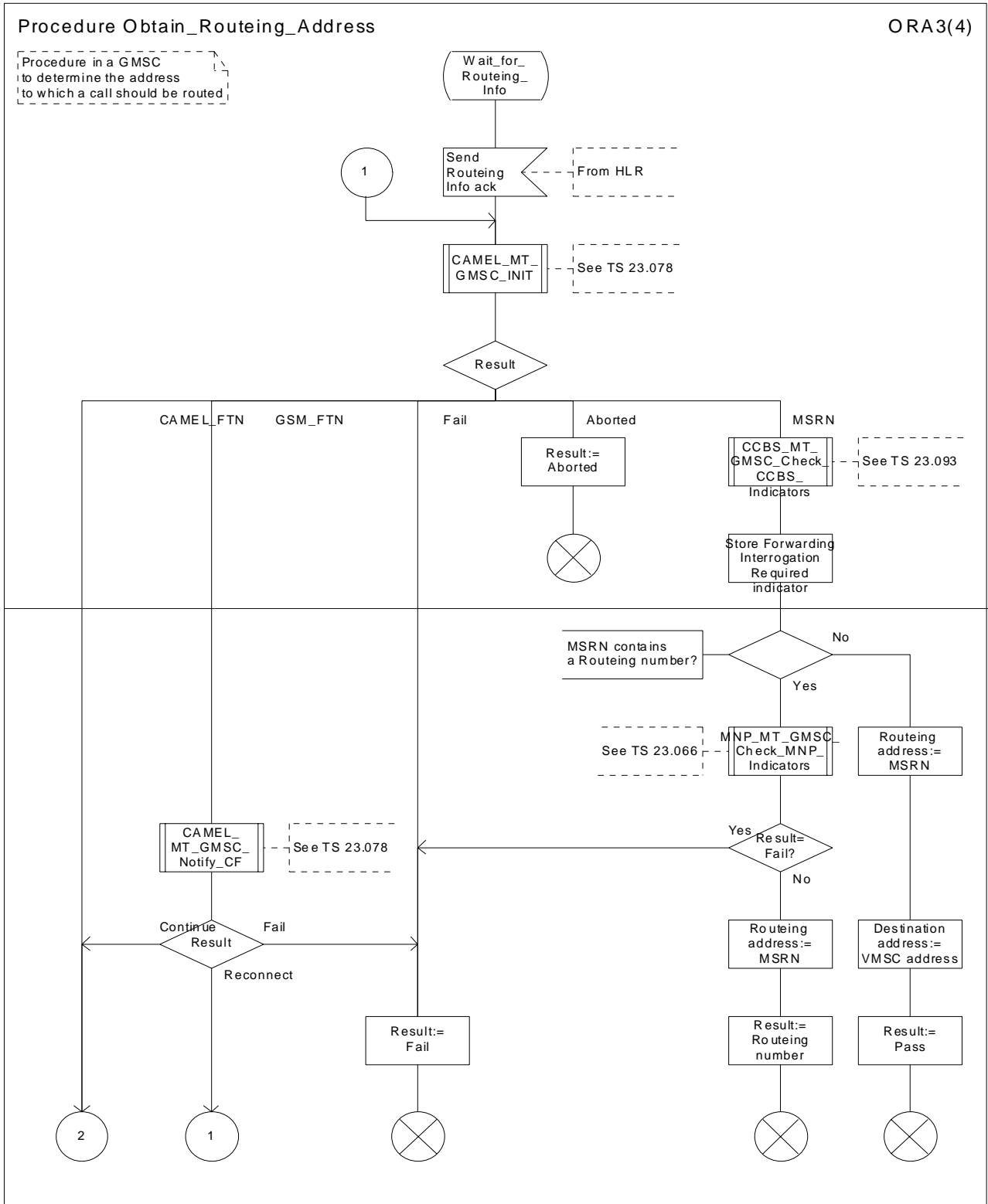

Figure 36c: Procedure Obtain_Routeing_Address (sheet 3)

*****Next Modified Section*****

8.2.2 Send Routeing Info ack

The following information elements are required:

Information element name	Required	Description
IMSI	M	IMSI of the B subscriber (see 3G TS 23.003 [5]).
Roaming number	C	E.164 number required to route the call to VMSCB (see 3G TS 23.003 [5]). Shall be present if the HLR received it in the Provide Roaming Number ack and the call is not subject to early CF , otherwise shall be absent.
Forwarded-to number	C	E.164 number of the C subscriber. Shall be present if the HLR has determined that the call is to be forwarded, otherwise shall be absent.
Forwarded-to subaddress	C	Subaddress of the C subscriber (see 3G TS 23.003 [5]). Shall be present if the HLR has determined that the call is to be forwarded and a forwarded-to subaddress is stored in the HLR in association with the forwarded-to number, otherwise shall be absent.
Notification to calling party	C	Indication of whether the calling party is to be notified that the call has been forwarded. Shall be present if the HLR has determined that the call is to be forwarded, otherwise shall be absent.
Forwarding reason	C	Indication of why the call has been forwarded (unconditionally or on mobile subscriber not reachable). Shall be present if the HLR has determined that the call is to be forwarded, otherwise shall be absent.
Redirecting presentation	C	Indication of whether the MSISDN of B subscriber shall be presented to the C subscriber. Shall be present if the HLR has determined that the call is to be forwarded, otherwise shall be absent.
MSISDN	C	E.164 number which identifies the B subscriber (basic MSISDN). It will be used to create the redirecting number presented to the C subscriber. Shall be present if the HLR has determined that the call is to be forwarded, otherwise shall be absent.
CUG interlock	C	For the definition of this IE, see 3G TS 23.085 [18]. Shall be present if the HLR has determined that the call is to be treated as a CUG call in accordance with the rules in 3G TS 23.085 [18], otherwise shall be absent.
CUG outgoing access	C	For the definition of this IE, see 3G TS 23.085 [18]. Shall be present if the HLR has determined that the call is to be treated as a CUG call with outgoing access in accordance with the rules in 3G TS 23.085 [18], otherwise shall be absent.
<u>NAEA preferred Carrier Id</u>	O	The preferred carrier identity identifying the carrier to be used to route the interexchange call if the call requires routing via an interexchange carrier. This parameter may be included at the discretion of the HLR operator.

*****End of document*****

CHANGE REQUEST		Please see embedded help file at the bottom of this page for instructions on how to fill in this form correctly.	
23.082 CR 008		Current Version: 3.2.0	
GSM (AA.BB) or 3G (AA.BBB) specification number ↑		↑ CR number as allocated by MCC support team	
For submission to: CN#09	for approval <input checked="" type="checkbox"/>	strategic <input type="checkbox"/>	(for SMG use only)
<i>list expected approval meeting # here</i> ↑	for information <input type="checkbox"/>	non-strategic <input checked="" type="checkbox"/>	

Form: CR cover sheet, version 2 for 3GPP and SMG The latest version of this form is available from: <ftp://ftp.3gpp.org/Information/CR-Form-v2.doc>

Proposed change affects: (U)SIM ME UTRAN / Radio Core Network
(at least one should be marked with an X)

Source: N4 **Date:** 2000-06-26

Subject: SDL refresh

Work item: TEI

Category:	F Correction <input type="checkbox"/> A Corresponds to a correction in an earlier release <input type="checkbox"/> B Addition of feature <input type="checkbox"/> C Functional modification of feature <input type="checkbox"/> D Editorial modification <input checked="" type="checkbox"/>	Release:	Phase 2 <input type="checkbox"/> Release 96 <input type="checkbox"/> Release 97 <input type="checkbox"/> Release 98 <input type="checkbox"/> Release 99 <input checked="" type="checkbox"/> Release 00 <input type="checkbox"/>
(only one category Shall be marked With an X)			

Reason for change: The SDL diagrams in this document have been replaced, without any semantic changes due to the following reasons:

- In the previous version, the diagrams contained nothing but garbage when viewed on-screen.
- Some of the diagrams were, if not impossible, very hard to print.
- A binary version of the SDL diagrams, suitable for standard tools, is needed to assure a qualitative handling of the diagrams in the future. Telelogic Tau SDL Suite (formerly known as SDT) versions of the diagrams have been created and made available, providing a new fresh base for future changes. For obvious reasons, the binary version, to be regarded as the source, should be mirrored in the document. Therefore, the diagrams replacing the previous versions are printouts of the binary versions.

Clauses affected: All figures in the document, containing an SDL diagram.

Other specs Affected:	Other 3G core specifications <input type="checkbox"/> Other GSM core specifications <input type="checkbox"/> MS test specifications <input type="checkbox"/> BSS test specifications <input type="checkbox"/> O&M specifications <input type="checkbox"/>	→ List of CRs: → List of CRs: → List of CRs: → List of CRs: → List of CRs:	
------------------------------	---	--	--

Other comments: ETSI plans to make the binary versions of the SDL diagrams available on the 3GPP website.

1 Call forwarding unconditional (CFU)

1.1 Handling of call forwarding unconditional

1.1.1 Registration

At the beginning of registration subscription to the basic service, provision of the supplementary service and sufficiency of registration information has to be checked (see figure 1.2).

The following information has to be registered in the network:

- 1) the forwarded-to number (possibly including a sub-address);
- 2) information as to whether all calls or all calls of a specific basic service group should be forwarded.

The basic service group code

If the registration request received by the HLR does not contain any basic service group code, the registration shall be performed for all subscribed basic service groups for which CFU is provided, see figure 1.2.

The forwarded-to number

If the forwarded-to number is a number in the HPLMN country, it may be entered by the served mobile subscriber in three different formats, independent of his actual location, according to the schemes:

- 1) national (significant) number;
- 2) (trunk) prefix plus national (significant) number;
- 3) international prefix, country code, national (significant) number.

The received number may have to be converted to an international number before further processing.

The network may also validate the forwarded-to number before accepting the call forwarding registration request.

If a served mobile subscriber is provided with the Translation Information Flag (TIF-CSI) as part of the CAMEL subscriber data (refer to TS 23.078), the network shall accept and store the forwarded-to number transparently at the time of registration. In this case the network shall neither convert nor validate the received number. Therefore the forwarded-to number may not comply with the schemes indicated above.

For further details related to the handling of the forwarded-to number refer to figure 1.2.

Supplementary Service interaction

Possible interaction situations between CFU and other call forwarding and barring supplementary services must then be checked. This is described in figure 1.2. Also see technical specifications 3G TS 22.004 and 3G TS 22.082. For interaction between CFU and other supplementary services (ie not call barring or call forwarding services), the reader is referred to the respective technical specification for those supplementary services.

Interaction with CAMEL Phase 2 or higher

Possible interaction between CFU and CAMEL Phase 2 or higher is described in figure 1.2. If CAMEL Phase 2 or higher is not supported in the HLR, processing continues from the "No" exit of the test "Result=Pass".

Notifications to the subscriber

When the mobile subscriber registers CFU, the network shall attempt to register and activate the service. The network will return notification of acceptance of the request. This notification will include the forwarded-to number and possibly the basic service group code to which CFU is registered.

If the system cannot accept a registration request, the network sends a notification that CFU registration was not successful to the served mobile subscriber.

The information flow for registration of CFU is shown in figure 1.1.

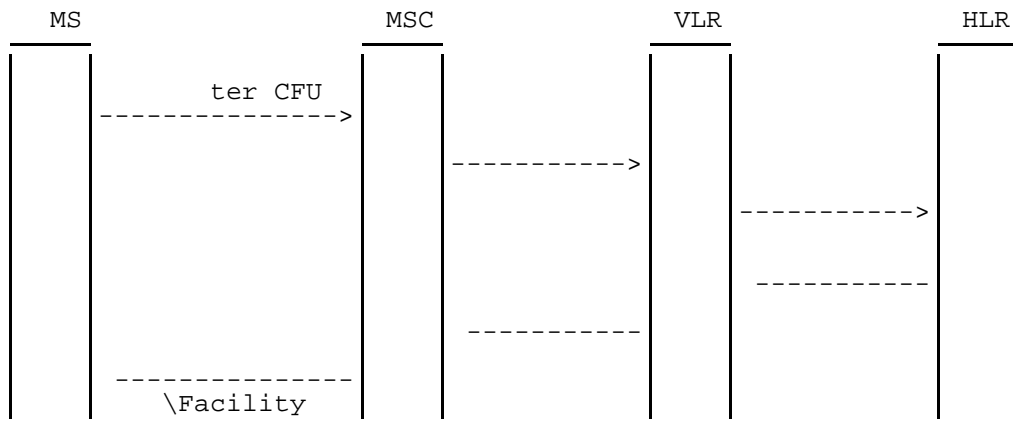
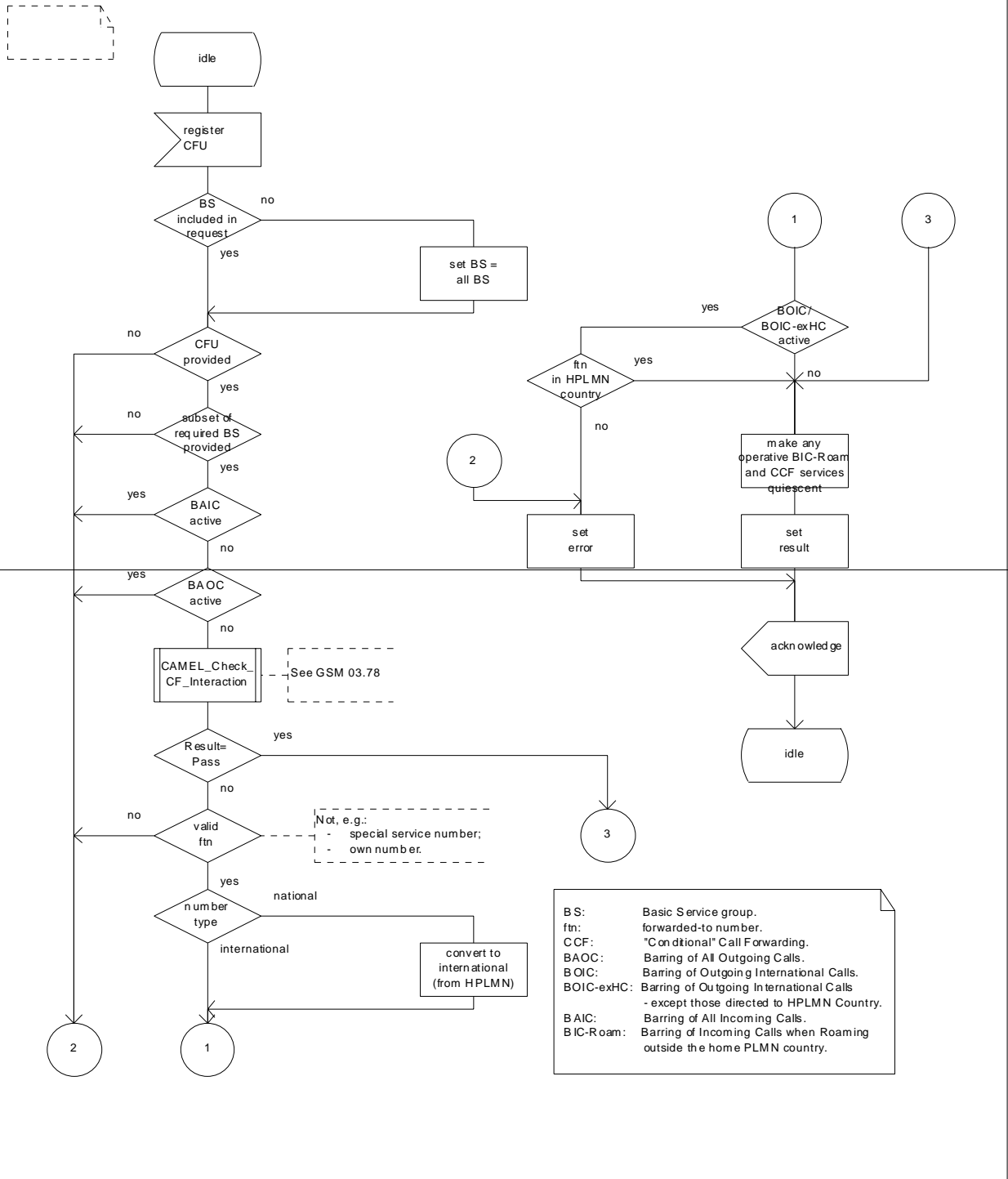

Figure 1.1: Registration of call forwarding unconditional

Process CFU1

382_12(1)



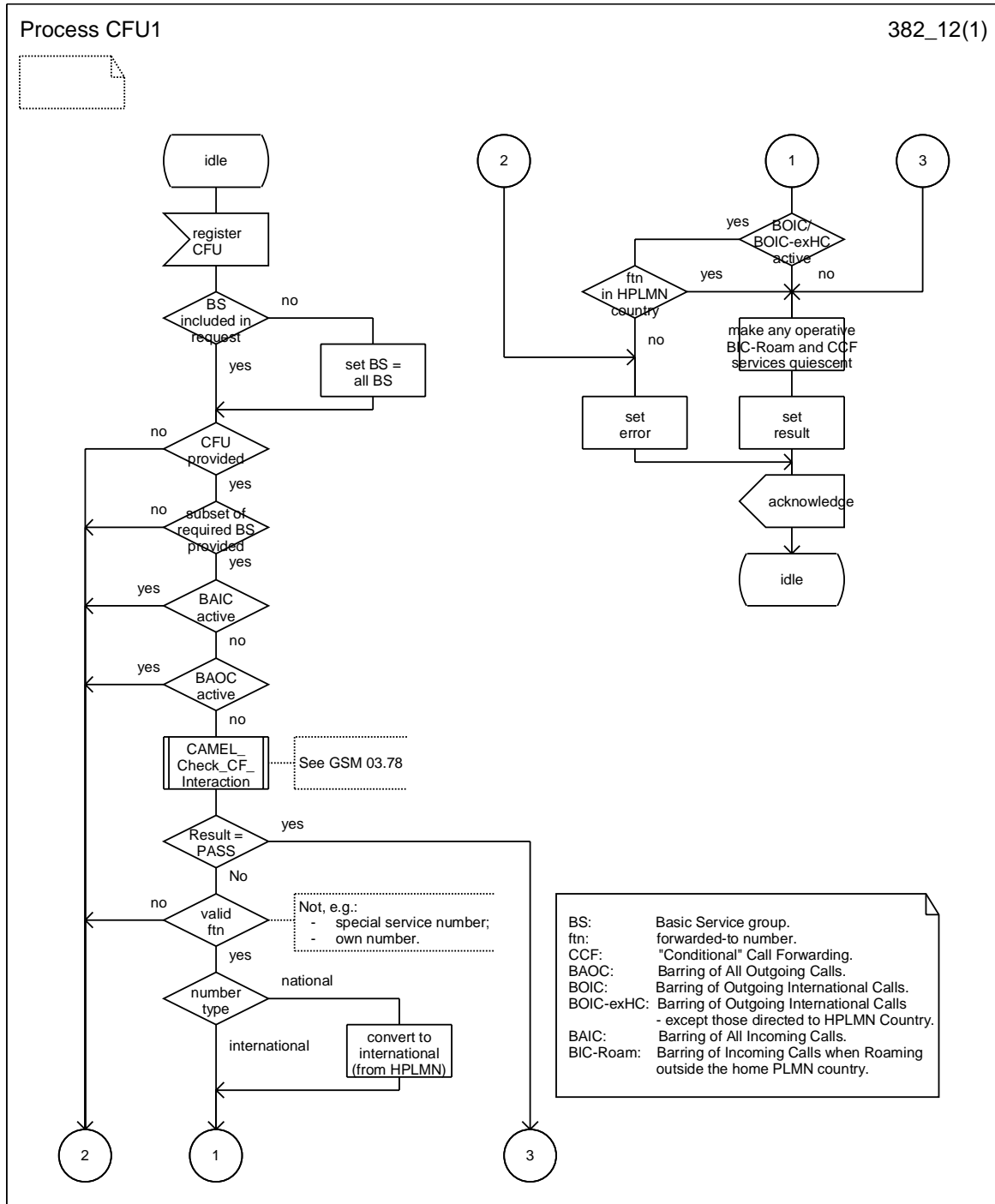

Figure 1.2: CFU1 Call forwarding unconditional registration process

1.1.2 Erasure

A previous registration can be erased in either of the following three ways:

- the subscriber can specifically erase a previous registration (to a basic service group) with an appropriate control procedure;
- the subscriber can register information for CFU (to a basic service group), thus causing previous registrations of CFU to be overridden (in the network this shall be handled as an erasure immediately followed by a registration);
- all information is erased as a result of withdrawal of the supplementary service (administrative handling).

The basic service group code

If the erasure request received by the HLR does not contain any basic service group code, the erasure request applies for all basic service groups for which CFU is registered. See figure 1.4.

Supplementary Service interaction

Possible interaction situations between CFU and other supplementary services must then be checked. This is shown in figure 1.4. Also see technical specifications 3G TS 22.004 and 3G TS 22.082. For interaction between CFU and other supplementary services (ie not call barring or call forwarding services), the reader is referred to the respective technical specification for those supplementary services.

Notifications to the subscriber

When the mobile subscriber erases CFU, the network shall attempt to erase (and thus deactivate) the service. The network shall send an indication of acceptance or rejection of the erasure request to the served mobile station.

The information flow for erasure of CFU is shown in figure 1.3.

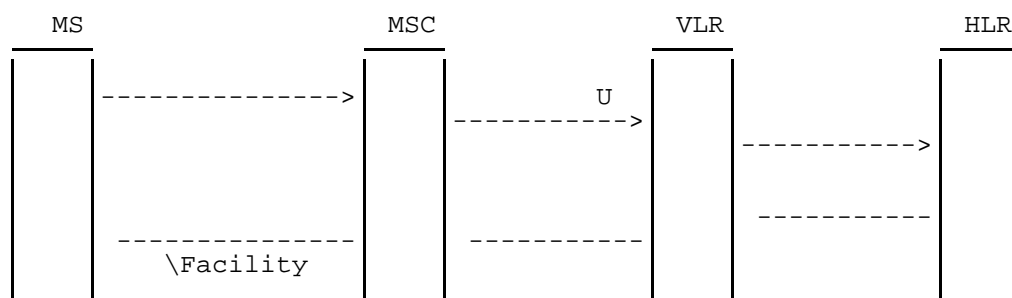
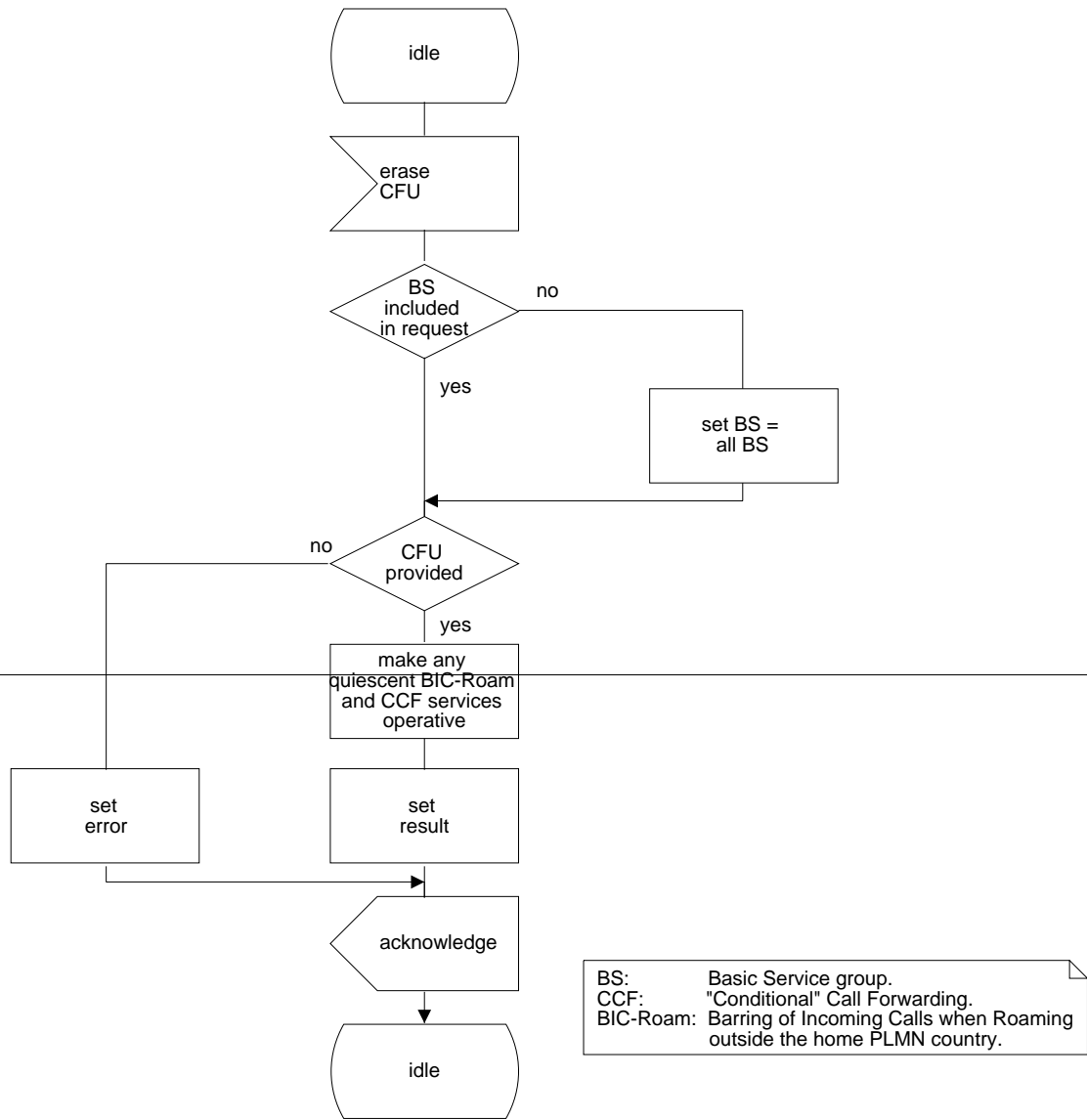

Figure 1.3: Erasure of call forwarding unconditional

Process CFU2

382_14(1)



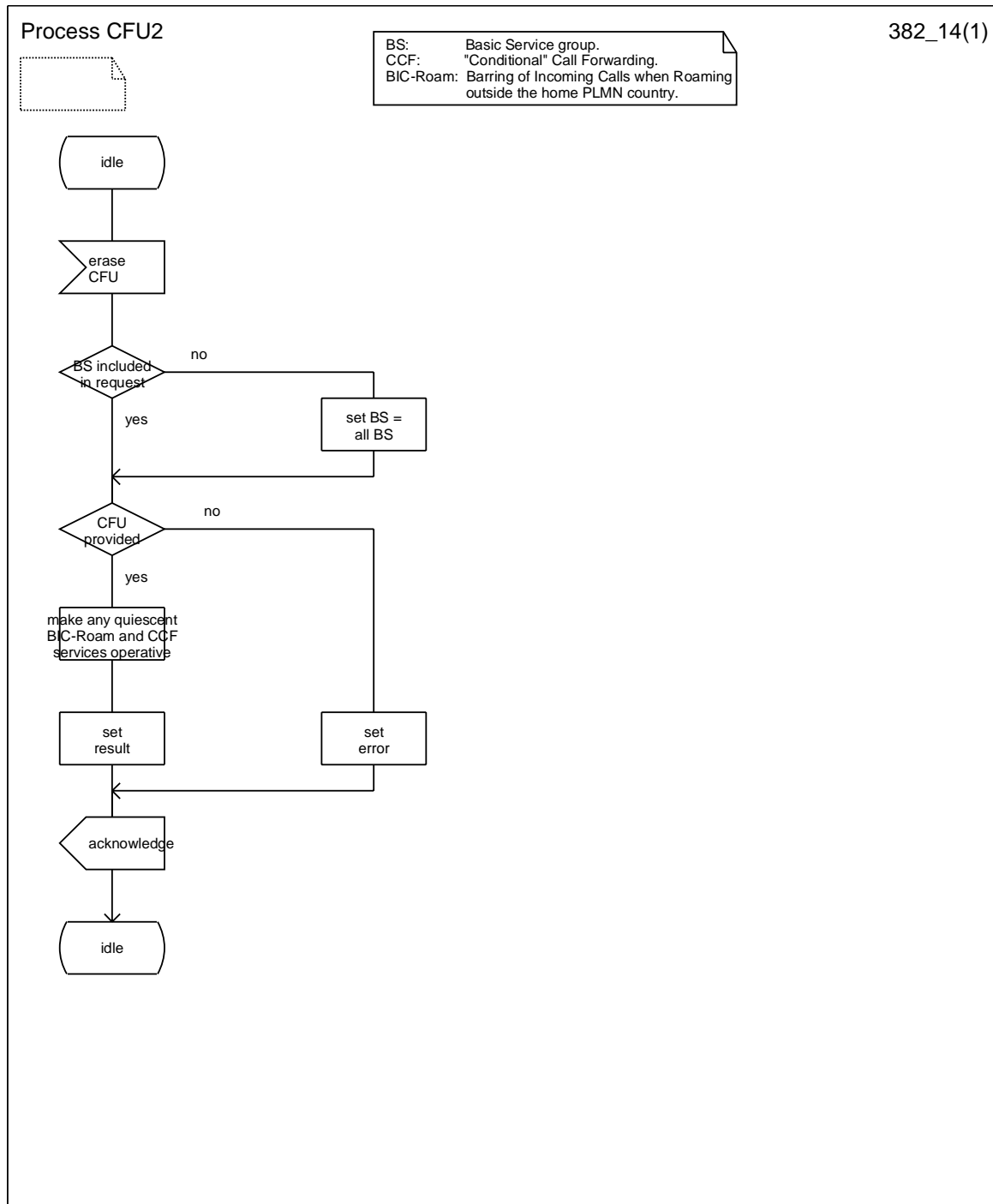

Figure 1.4: CFU2 Call forwarding unconditional erasure process

1.1.3 Activation

The network initially checks subscription to the basic service and registration status of the supplementary service, see figure 1.6.

Possible interaction situations between CFU and other supplementary services must then be checked. The SDL diagrams in figure 1.6 shows the function to be performed in the HLR in order to deal with the interactions between CFU and the call restriction and conditional call forwarding services. Also see 3G TS 22.004 and 3G TS 22.082. For interaction between CFU and other supplementary services (ie not call barring or call forwarding services), the reader is referred to the respective technical specification for those supplementary services.

The Basic Service Group Code

If the activation request received by the HLR doesn't contain any basic service group code, the activation request shall apply to all subscribed basic service groups against which a CFU forwarded-to number is registered. If a forwarded-to number is not registered against even a subset of the required basic service group, the request will be rejected.

Note that according to 3G TS 22.004, a request for activation shall still be accepted although the CFU supplementary service was already active for all basic service groups.

Notification to the subscriber

The network will return notification of acceptance, partial acceptance or rejection of the request to the mobile station.

The information flow for activation of CFU is shown in figure 1.5.

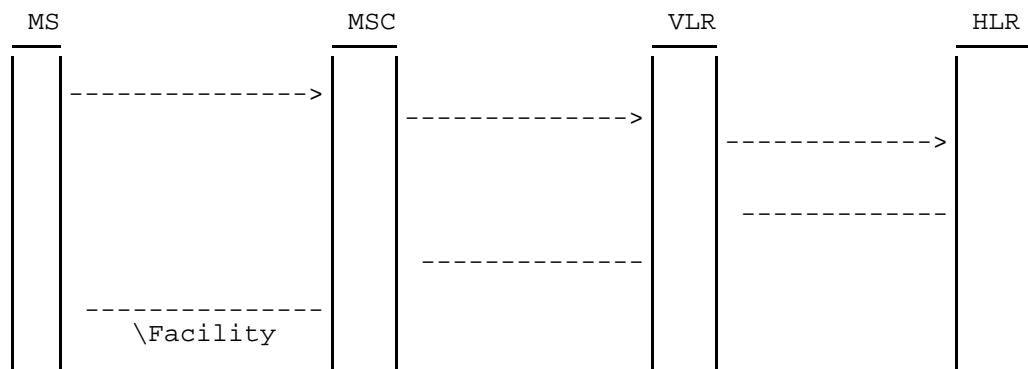
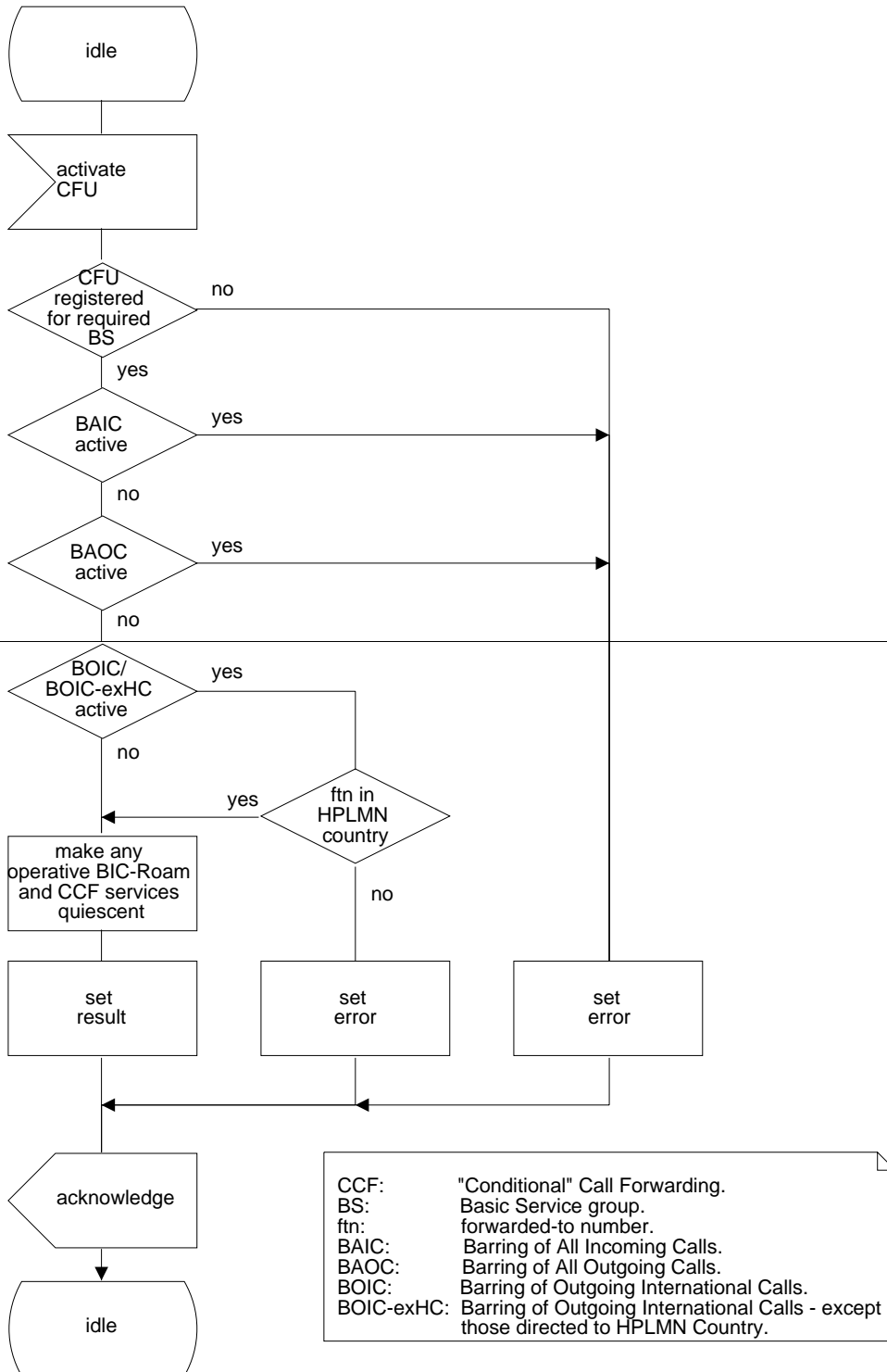

Figure 1.5: Activation of call forwarding unconditional

Process CFU3

382_16(1)



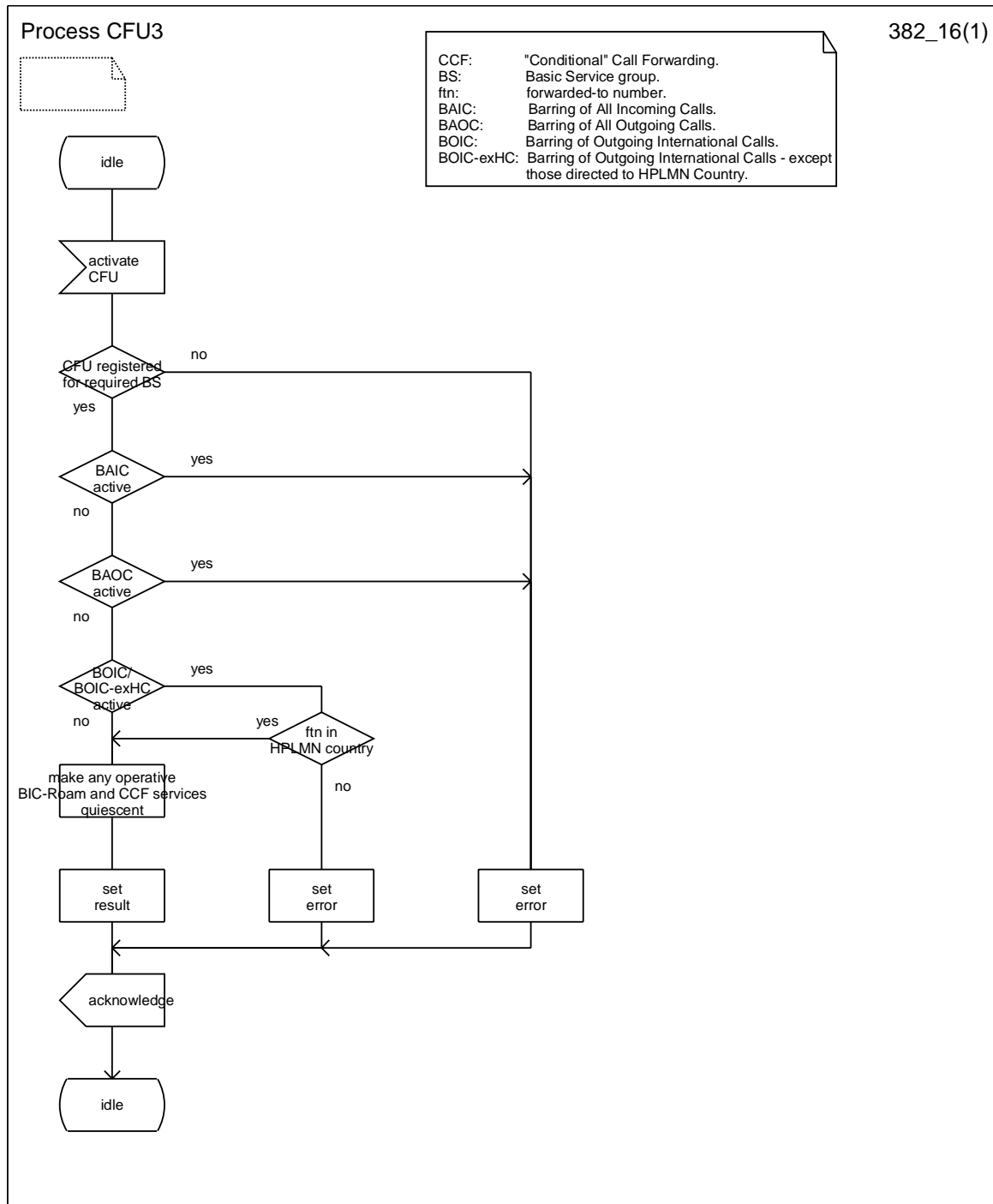

Figure 1.6: CFU3 Call forwarding unconditional activation process

1.1.4 Deactivation

The previous activation can be deactivated in either of the following three ways:

- the subscriber can specifically deactivate a previous activation (to a basic service group) with an appropriate control procedure;
- the subscriber can register information for CFU (to a basic service group), thus causing previous registrations and activations of CFU to be overridden (this shall be handled in the same way as an erasure (implying deactivation) immediately followed by a registration (implying activation));
- the service is deactivated as a result of withdrawal of the supplementary service (administrative handling).

Possible interaction situations between CFU and other supplementary services must be checked. The SDL diagram in figure 1.8 shows the function to be performed in the HLR in order to deal with the possible interactions between CFU and the conditional call forwarding services.

The Basic Service Group Code

The CFU deactivation request may specify a basic service group for which deactivation is required. If the deactivation request received by the HLR doesn't contain any basic service group code, the deactivation request shall apply to all basic services for which CFU is active, see figure 1.8.

If the deactivation request received by the HLR contains a basic service group code, only information related to the specified basic service group(s) is affected. Note that according to 3G TS 22.004, a request for deactivation shall still be accepted even if the CFU supplementary service was already deactive for all basic service groups.

The user shall receive a notification of acceptance or rejection of the CFU deactivation request.

The information flow for deactivation of call forwarding unconditional is shown in figure 1.7.

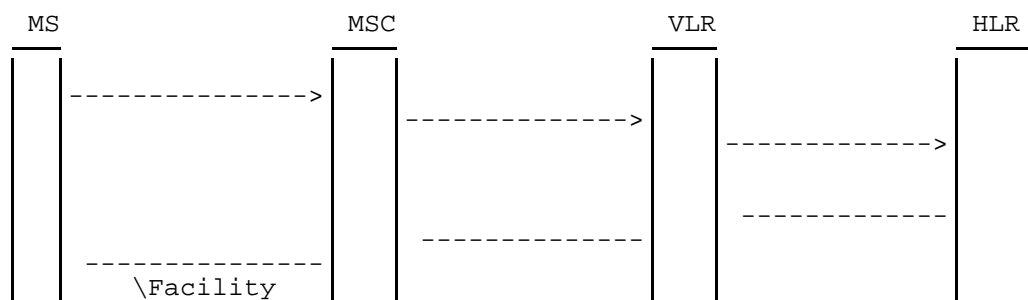
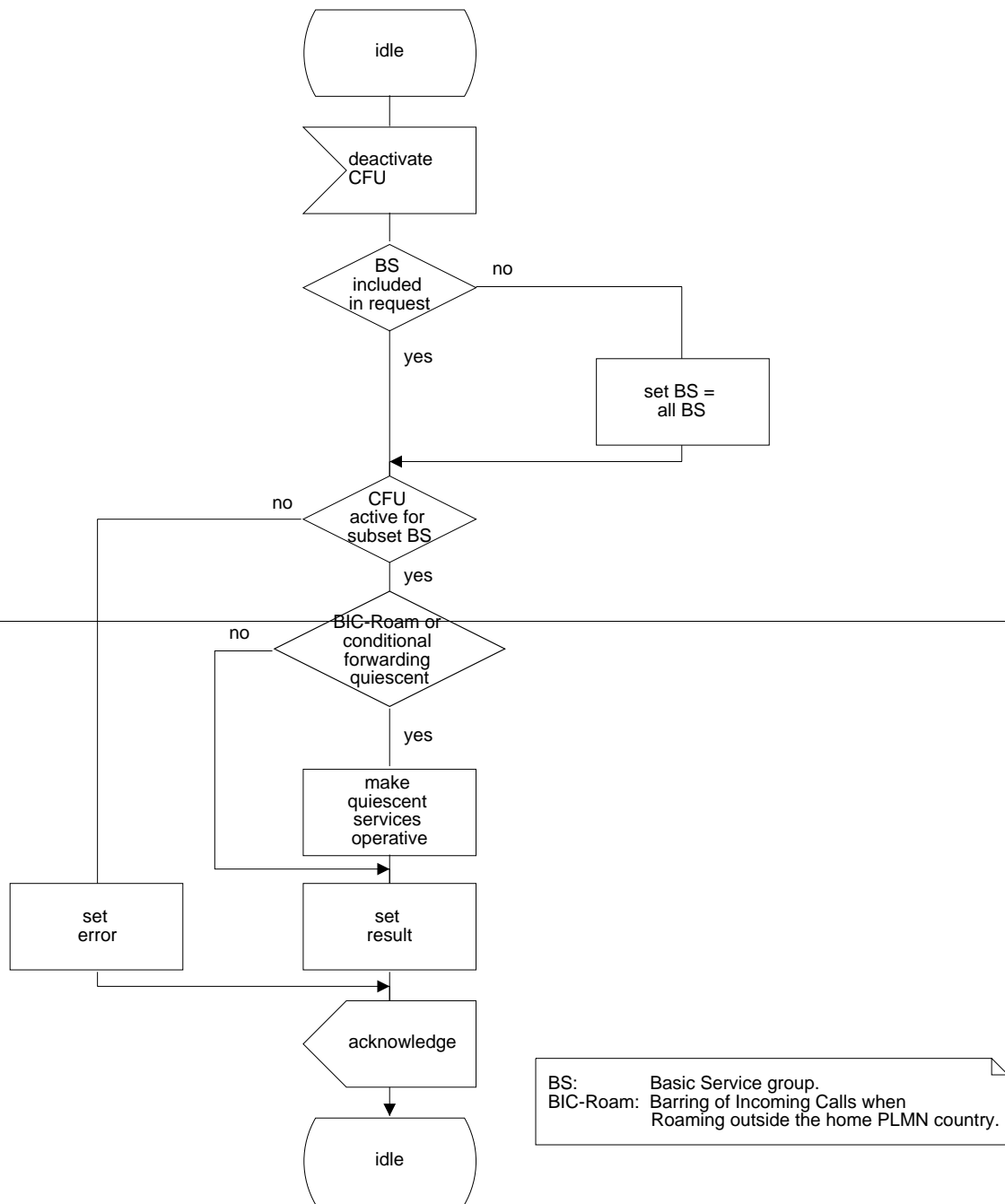

Figure 1.7: Deactivation of call forwarding unconditional

Process CFU4

382_18(1)



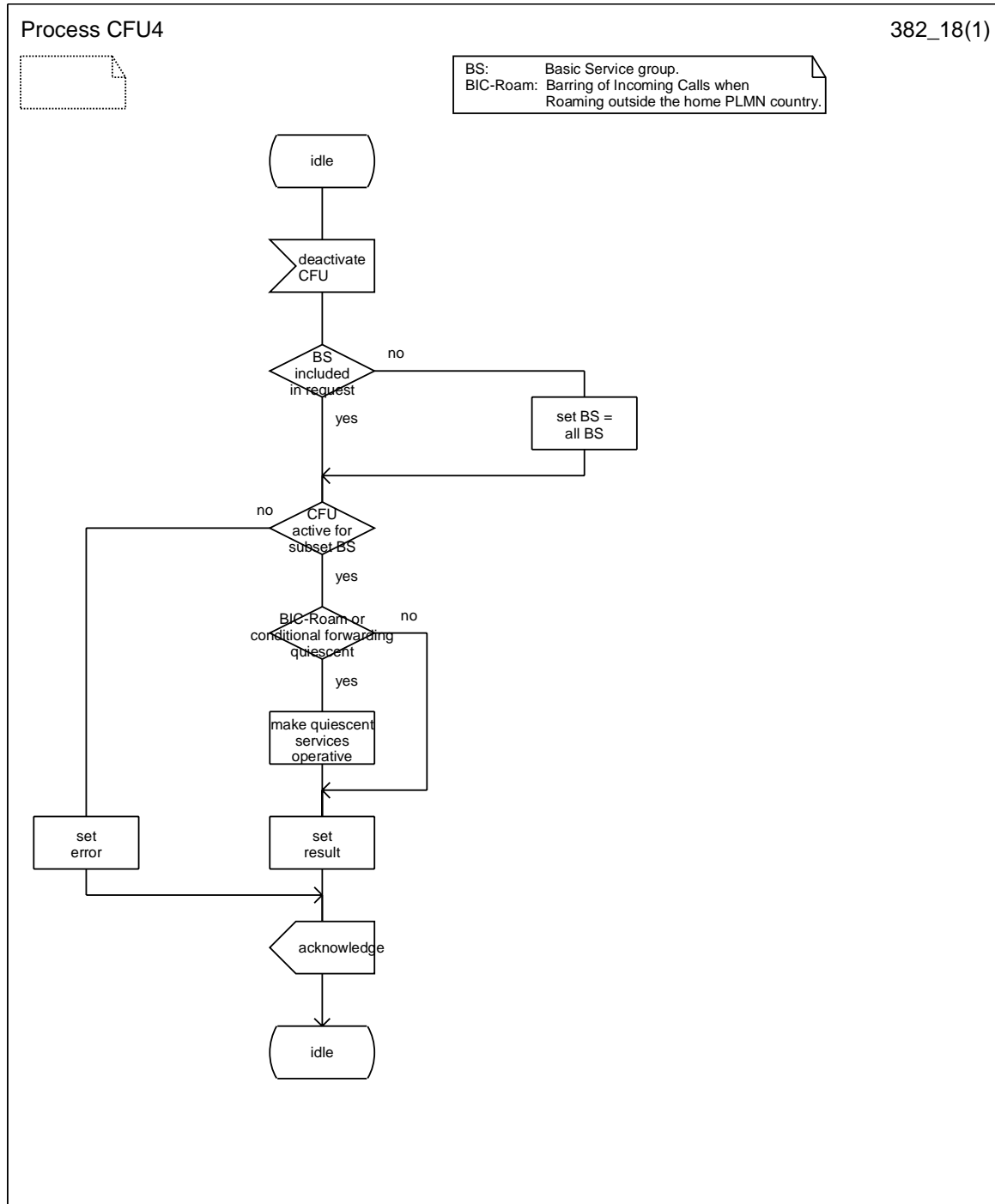

Figure 1.8: CFU4 Call forwarding unconditional deactivation process

1.1.5 Interrogation

Data request

The data request procedure enables the mobile subscriber to obtain information about the data stored in the PLMN. Interrogation of CFU is handled by the HLR which returns the required information or error to the MS, see figure 1.9.

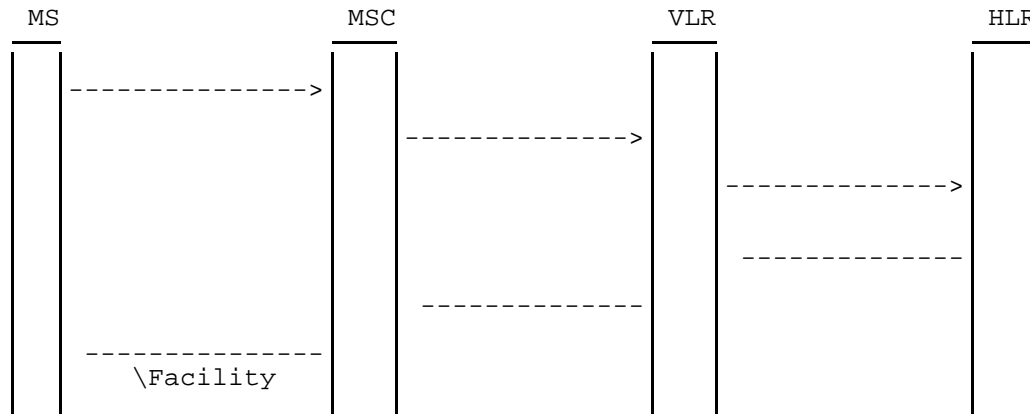

Figure 1.9: Interrogation of call forwarding unconditional

1.2 Functions and information flows

The following Mobile Additional Function has been identified for the PLMN:

MAF007

Call forwarding unconditional authorizations examination

The ability of a PLMN component to determine the authorizations relating to CFU.

See figure 1.10.

Location: HLR.

The information flow for call forwarding unconditional is shown in figure 1.11.

Process MAF007

382_1A(1)

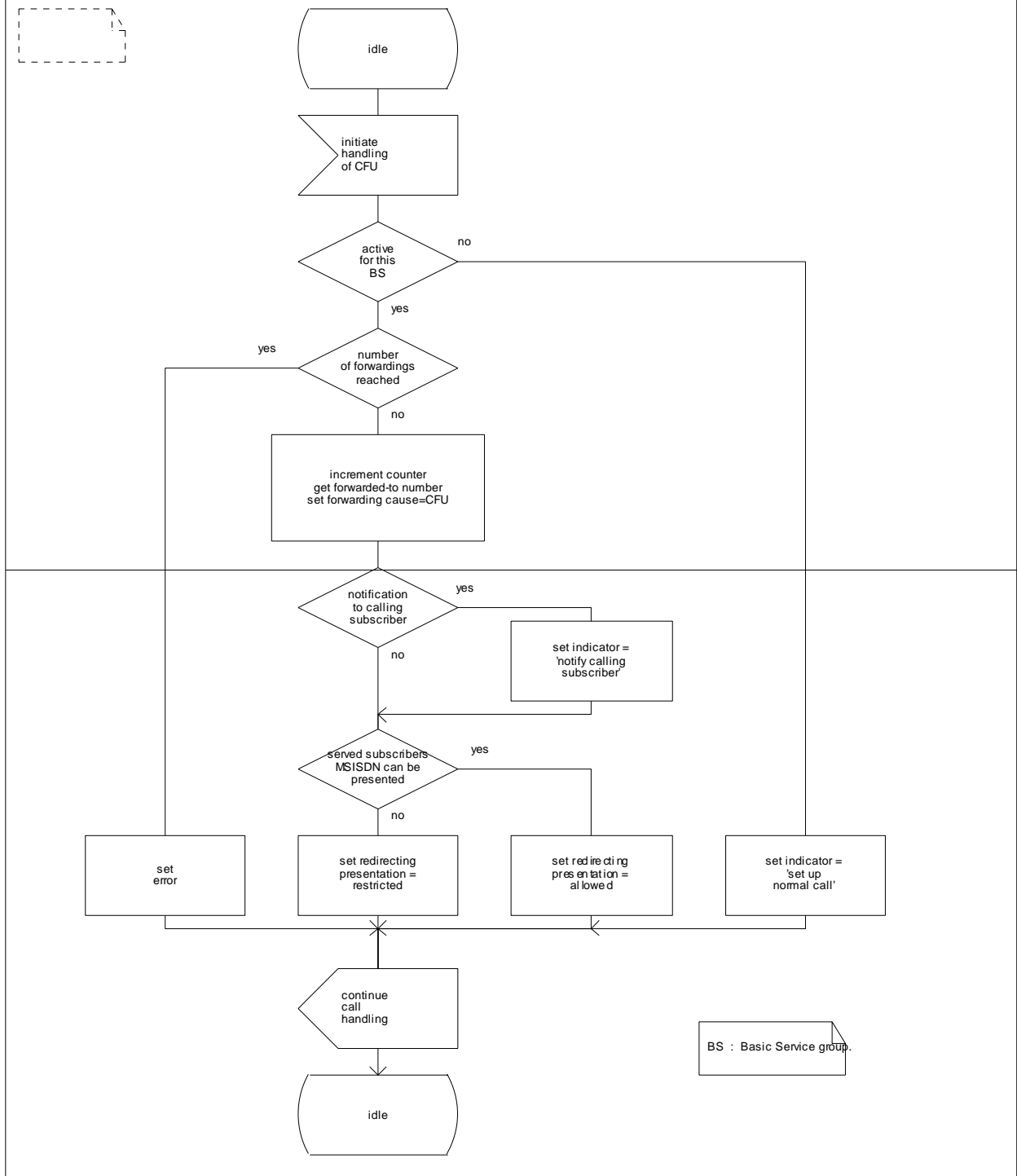

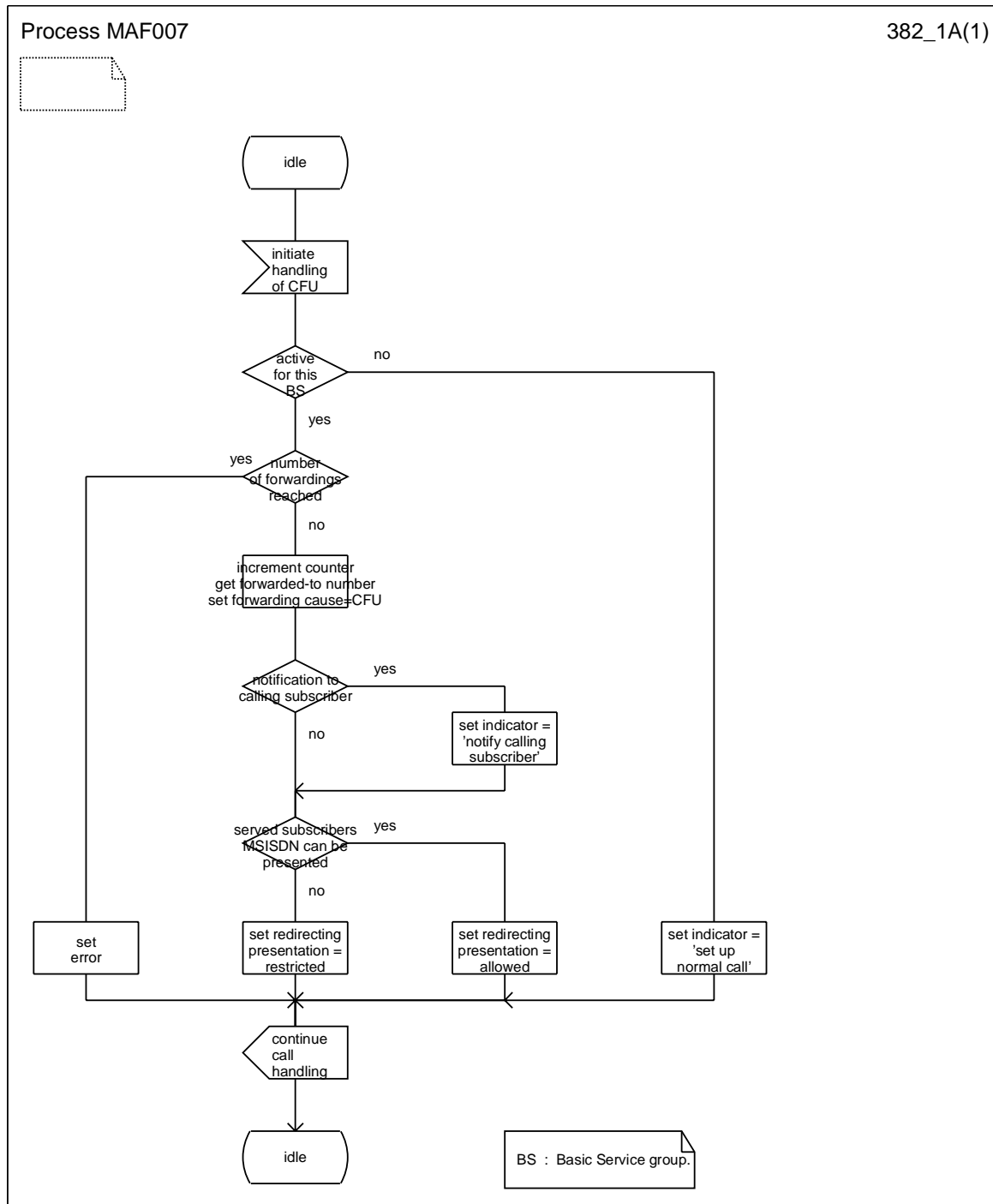
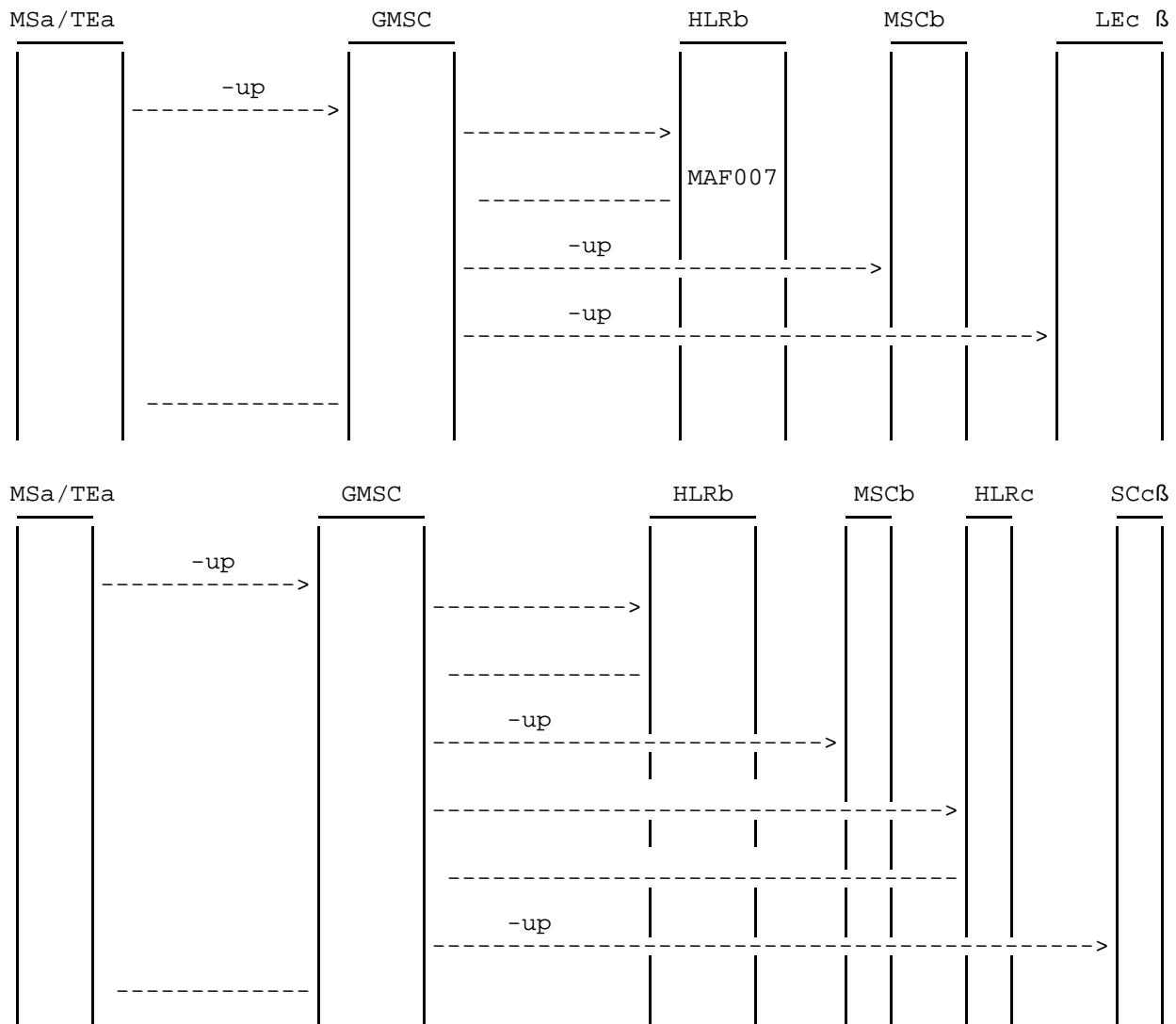

Figure 1.10: MAF007 Call forwarding unconditional authorisations examination (HLR)



NOTE: info: information Y: Yes
 req: request N: No
 ack: acknowledge
 OR1: Forwarding requested
 OR2: Notification to calling subscriber required

Figure 1.11: Information flow for call forwarding unconditional

1.3 Information stored in the HLR

The following logical states are applicable for CFU (refer to 3G TS 23.011 for an explanation of the notation):

Provisioning State	Registration State	Activation State	HLR Induction State
(Not Provisioned,	Not Registered,	Not Active,	Not Induced)
(Provisioned,	Not Registered,	Not Active,	Not Induced)
(Provisioned,	Registered,	Not Active,	Not Induced)
(Provisioned,	Registered,	Active and Quiescent,	Not Induced)
(Provisioned,	Registered,	Active and Operative,	Not Induced)

The registration and activation state may be different for each applicable elementary basic service group.

The provisioning state shall be on a per subscriber basis, and hence the same for all basic service groups.

The HLR shall store:

- the state of CFU (which shall be one of the valid states listed above) for each applicable elementary basic service group;
- the subscription option "notification to the calling party" on a per subscriber basis;

This subscription option takes one of the following values:

- no notification;
 - notification.
- the subscription option "MSISDN of the served subscriber can be presented to the forwarded-to subscriber" on a per subscriber basis;

This subscription option takes one of the following values:

- presentation restricted;
- presentation allowed.

the registration parameter "forwarded-to number" (possibly including a forwarded-to sub-address) for each applicable elementary basic service group.

Note that the value "Active and Quiescent" of the activation state is required in case of interaction with Operator Determined Barring (see 3G TS 23.015).

1.4 State transition model

The following figure shows the successful cases of transition between the applicable logical states of CFU. The state changes are either caused by actions of the service provider, the mobile user or the network.

Note that error cases are not shown in the diagram as they normally do not cause a state change. Additionally, some successful requests may not cause a state change. Hence, they are not shown in the diagram.

The diagram only shows operations on an elementary basic service group.

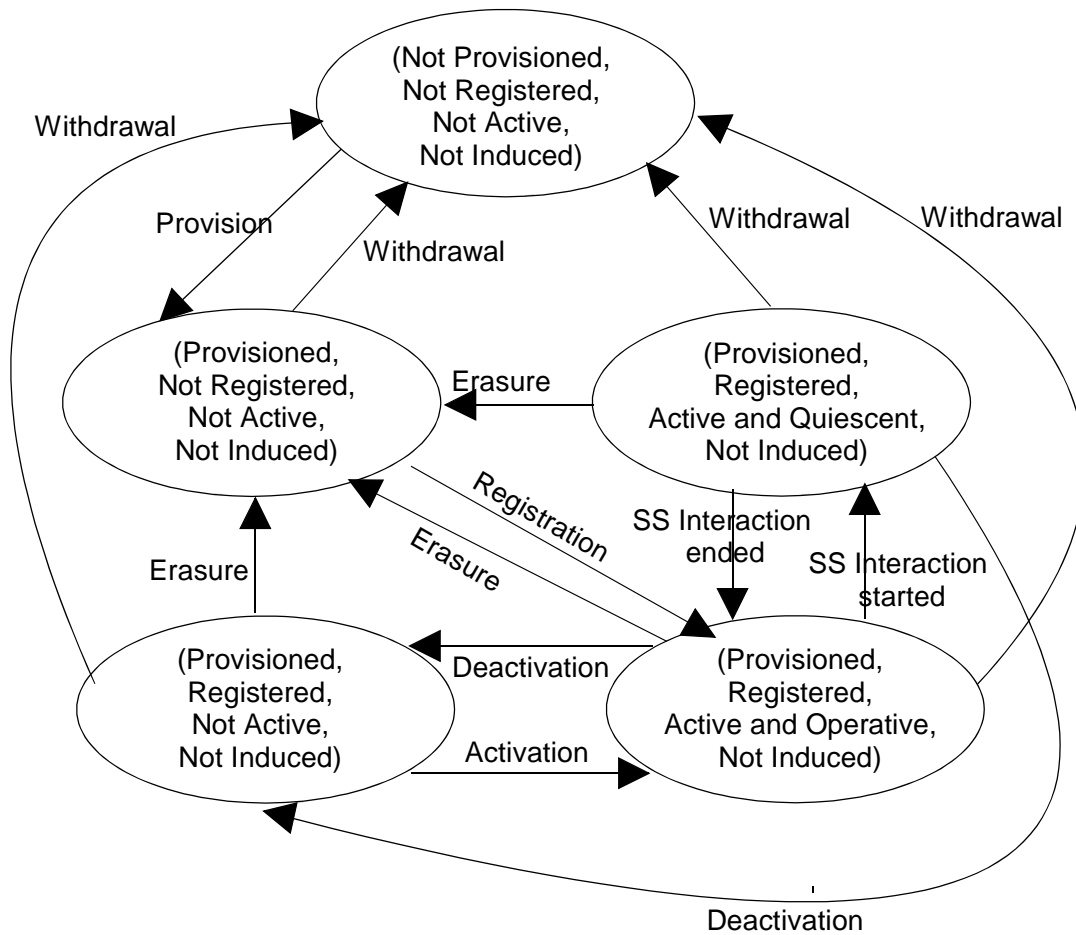

Figure 1.12: State transition model for CFU

1.5 Transfer of information from HLR to VLR

If the provisioning state for CFU is "Provisioned" then, when the subscriber registers on a VLR, the HLR shall send that VLR information about the logical state of CFU for all relevant elementary basic service groups.

If the logical state of CFU is changed while a subscriber is registered on a VLR then for the affected basic service groups, the HLR shall inform the VLR of the new logical state of CFU.

1.6 Information stored in the VLR

For CFU the VLR shall store the service state information received from the HLR for all relevant elementary basic service groups.

1.7 Handover

Handover will have no impact on the control procedure and the operation of the service.

1.8 Cross phase compatibility

1.8.1 MS, MSC, VLR or HLR only support Phase 1 control of SS by the subscriber

In response to a CFU interrogation request, if the MS or any network element involved is of Phase 1, only information concerning basic service groups for which the activation state has the value "Active and Operative" will be returned. This means, for example, that the subscriber will not be aware that the forwarded to number is registered if CFU is deactivated. A subaddress (if registered) will not be included in the response.

Note that if any network element involved is of Phase 1, CFU Registration requests which use a subaddress and all CFU Activation and Deactivation requests will be rejected, as these are not specified in Phase 1.

1.8.2 HLR only supports Phase 1 updating of subscriber information

The VLR shall ignore the subscription option "notification to the calling party" and the registration parameter "forwarded to number" when received from a Phase 1 HLR.

If the VLR receives the SS-Status parameter from a Phase 1 HLR it shall act if it has received the SS-Status parameter with the values shown in the following:

- 1) Activated => A bit = 1, Q bit = 0;
- 2) Deactivated => A bit = 0, Q bit = 0 or 1

1.8.3 VLR only supports Phase 1 updating of subscriber information

When passing CFU information to a Phase 1 VLR, the HLR shall send the service state information in a form which the VLR can accept, based on the logical state held in the HLR, as follows:

- 1) (Provisioned, Not Registered, Not Active, Not Induced)
=> Erased, Deactivated;
- 2) (Provisioned, Registered, Not Active, Not Induced)
=> Registered, Deactivated;
- 3) (Provisioned, Registered, Active and Operative, Not Induced)
=> Registered, Activated;
- 4) (Provisioned, Registered, Active and Quiescent, Not Induced)
=> Registered, Deactivated.

The HLR shall not pass a subaddress to a Phase 1 VLR.

1.8.4 GMSC only supports Phase 1 call handling

When a call is forwarded unconditionally, the HLR shall not pass the subaddress to a Phase 1 GMSC. Calls shall be forwarded without the subaddress.

1.8.5 GMSC does not support CAMEL or supports CAMEL Phase 1 only

If the activation state of CFU is "Active and Operative" and if the forwarded-to number is registered in a format other than international and if the GMSC does not support CAMEL or supports CAMEL Phase 1 only, then when a request for routing information for a mobile terminated call is received in the HLR, CFU shall not be invoked, i.e. the mobile terminated call establishment will be continued towards the served mobile subscriber.

1.9 Contents of Messages

1.9.1 Messages on the C interface (MSC-HLR)

1.9.1.4 Send Routing Info

This message is specified in 3G TS 23.018.

Send Routing Info contains the following IE specific to Long Forwarded-to Numbers:

Information element name	Required	Description
Long FTN supported	C	Shall be present if the GMSC supports Long Forwarded-to Numbers; otherwise shall be absent.

1.9.1.2 Send Routing Info ack

This message is specified in 3G TS 23.018.

Send Routing Info ack contains the following amendment to the Forwarded-to number IE and an additional IE specific to Long Forwarded-to Numbers:

Information element name	Required	Description
Forwarded-to number	C	E.164 number of the C subscriber. Shall be present if the HLR has determined that the call is to be forwarded and at least one of the HLR and GMSC does not support Long Forwarded-to Numbers; otherwise shall be absent.
Long forwarded-to number	C	Number of the C subscriber. Shall be present if the HLR has determined that the call is to be forwarded and Long Forwarded-to Numbers are supported by the HLR and the GMSC; otherwise shall be absent.

1.9.2 Messages on the Um, B and D interfaces (MS – network)

1.9.2.1 RegisterSS

This message corresponds to the MAP_REGISTER_SS service specified in 3G TS 29.002.

Information element name	Required	Description
Long FTN supported	C	Shall be present if the MS supports Long Forwarded-to Numbers; otherwise shall be absent.

1.9.2.2 ActivateSS

This message corresponds to the MAP_ACTIVATE_SS service specified in 3G TS 29.002.

Information element name	Required	Description
Long FTN supported	C	Shall be present if the MS supports Long Forwarded-to Numbers; otherwise shall be absent.

1.9.2.3 InterrogateSS

This message corresponds to the MAP_INTERROGATE_SS service specified in 3G TS 29.002.

Information element name	Required	Description
Long FTN supported	C	Shall be present if the MS supports Long Forwarded-to Numbers; otherwise shall be absent.

1.9.3 Information flows on the J interface (HLR – gsmSCF)

1.9.3.1 Any Time Subscription Interrogation

This IF is specified in 3G TS 23.078.

Any Time Subscription Interrogation contains the following IE specific to Long Forwarded-to Numbers:

Information element name	Required	Description
Long FTN supported	C	Shall be present if the gsmSCF supports Long Forwarded-to Numbers; otherwise shall be absent.

1.9.3.2 Any Time Subscription Interrogation ack

This IF is specified in 3G TS 23.078.

The Call forwarding SS data IE within the Any Time Subscription Interrogation ack IF contains the following amendment to the Forwarded-to number IE and an additional IE specific to Long Forwarded-to Numbers:

Information element name	Required	Description
Forwarded-to number	C	Shall be present if at least one of the HLR and the gsmSCF does not support Long Forwarded-to Numbers; otherwise shall be absent.
Long forwarded-to number	C	Shall be present if the HLR and the gsmSCF support Long Forwarded-to Numbers; otherwise shall be absent.

1.9.3.3 Any Time Modification

This IF is specified in 3G TS 23.078.

Any Time Modification contains the following IE specific to Long Forwarded-to Numbers:

Information element name	Required	Description
Long FTN supported	C	Shall be present if the gsmSCF supports Long Forwarded-to Numbers; otherwise shall be absent.

1.9.3.4 Any Time Modification ack

This IF is specified in 3G TS 23.078.

The Call forwarding SS data IE within the Any Time Modification ack IF contains the following amendment to the Forwarded-to number IE and an additional IE specific to Long Forwarded-to Numbers.

Information element name	Required	Description
Forwarded-to number	C	Shall be present if at least one of the HLR and the gsmSCF does not support Long Forwarded-to Numbers; otherwise shall be absent.
Long forwarded-to number	C	Shall be present if the HLR and the gsmSCF support Long Forwarded-to Numbers; otherwise shall be absent.

1.10 Exceptional Procedures

1.10.1 MS does not support Long Forwarded-to Numbers

The MS shall indicate whether it supports Long Forwarded-to Numbers in the RegisterSS, ActivateSS and InterrogateSS messages.

If the MS does not support Long Forwarded-to Numbers, and a long forwarded-to number is registered, the acknowledgement message shall contain a truncated version of the registered long forwarded-to number (i.e. the leading 15 digits of the registered long forwarded-to number).

1.10.2 HLR does not support Long Forwarded-to Numbers

The HLR shall not allow a subscriber to register a long forwarded-to number.

1.10.3 GMSC does not support Long Forwarded-to Numbers

The HLR can determine from the Send Routing Info message whether the GMSC supports Long Forwarded-to Numbers.

If the GMSC does not support Long Forwarded-to Numbers and the HLR identifies that CFU should be invoked, then:

- If the registered forwarded-to number contains a maximum of 15 digits then the HLR shall populate the Forwarded-to number parameter in the Send Routing Info ack message with the registered forwarded-to number.
- If the registered forwarded-to number contains more than 15 digits then, as a network option, the HLR can:
 - Populate the Forwarded-to number parameter in the Send Routing Info ack message with an alternative forwarded-to number (containing a maximum of 15 digits), or
 - Allow the call to continue without invoking CFU, or
 - Release the call.

2 Call forwarding on mobile subscriber busy

2.1 Handling of call forwarding on mobile subscriber busy

2.1.1 Registration

The same rules apply for the registration of Call Forwarding on Mobile Subscriber Busy as were described for Call Forwarding Unconditional in subclause 1.1.1 above, with the exception of the checking of interaction with other supplementary services. Basic registration of information is illustrated in figure 2.2.

Supplementary Service Interaction

Possible interaction situations between CFB and other supplementary services must then be checked. This is described in figure 2.2. Also see 3G TS 22.004 and 3G TS 22.082. For interaction between CFB and other supplementary services (ie not call barring or call forwarding services), the reader is referred to the respective technical specification for those supplementary services.

Interaction with CAMEL Phase 2 or higher

Possible interaction between CFB and CAMEL Phase 2 or higher is described in figure 2.2. If CAMEL Phase 2 or higher is not supported in the HLR, processing continues from the "No" exit of the test "Result=Pass".

The information flow for registration of CFB is shown in figure 2.1.

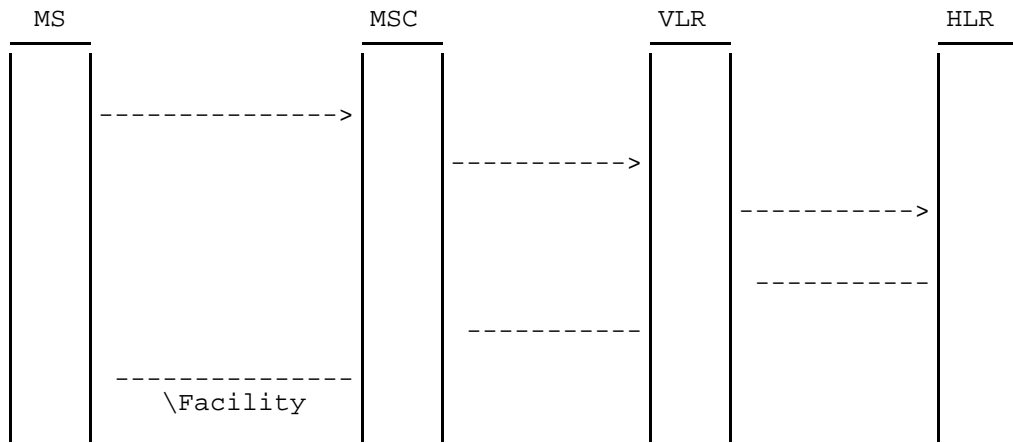
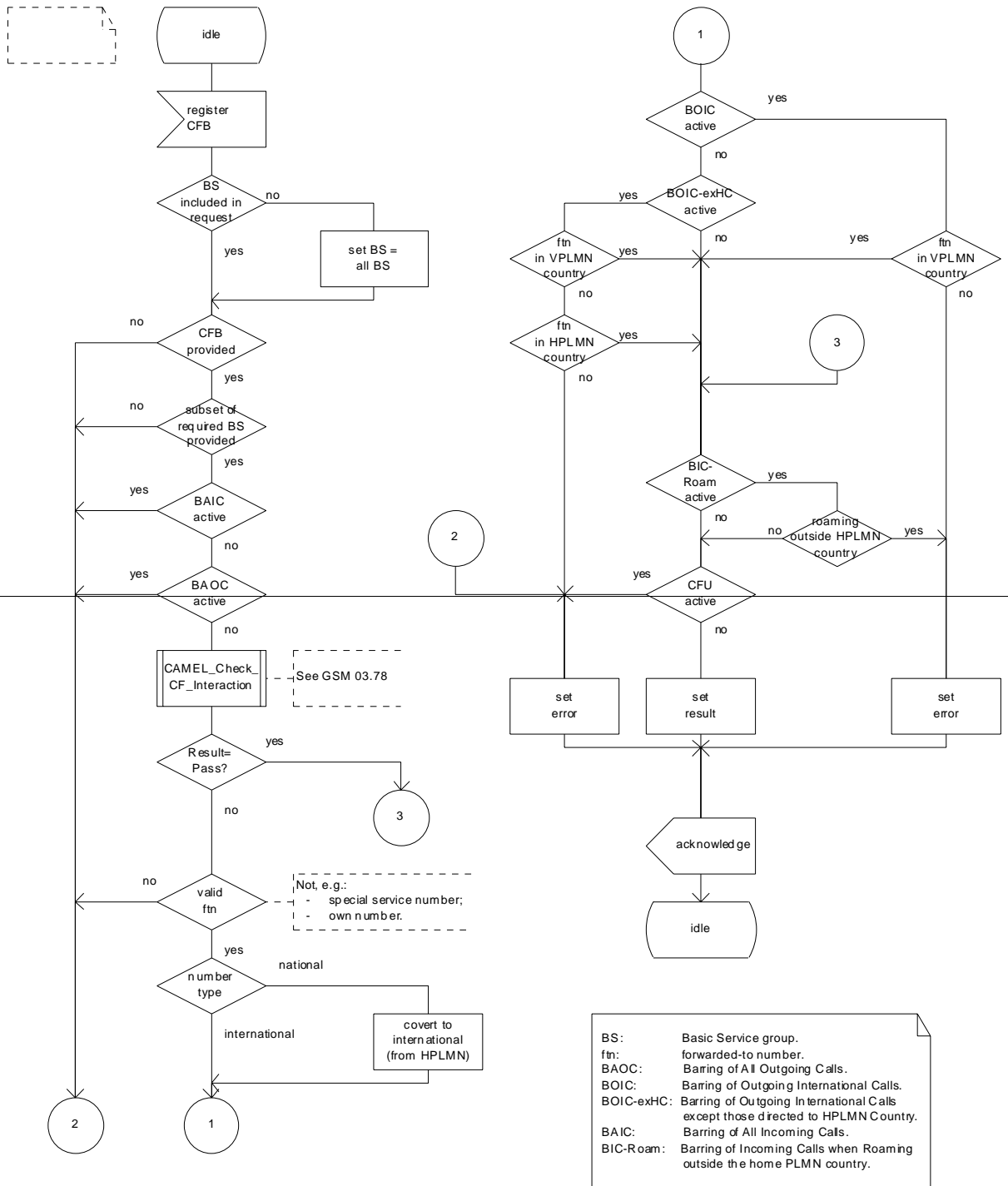

Figure 2.1: Registration of call forwarding on mobile subscriber busy

Process CFB1

382_22(1)



BS: Basic Service group.
ftn: forwarded-to number.
BAOC: Barring of All Outgoing Calls.
BOIC: Barring of Outgoing International Calls.
BOIC-exHC: Barring of Outgoing International Calls except those directed to HPLMN Country.
BAIC: Barring of All Incoming Calls.
BIC-Roam: Barring of Incoming Calls when Roaming outside the home PLMN country.

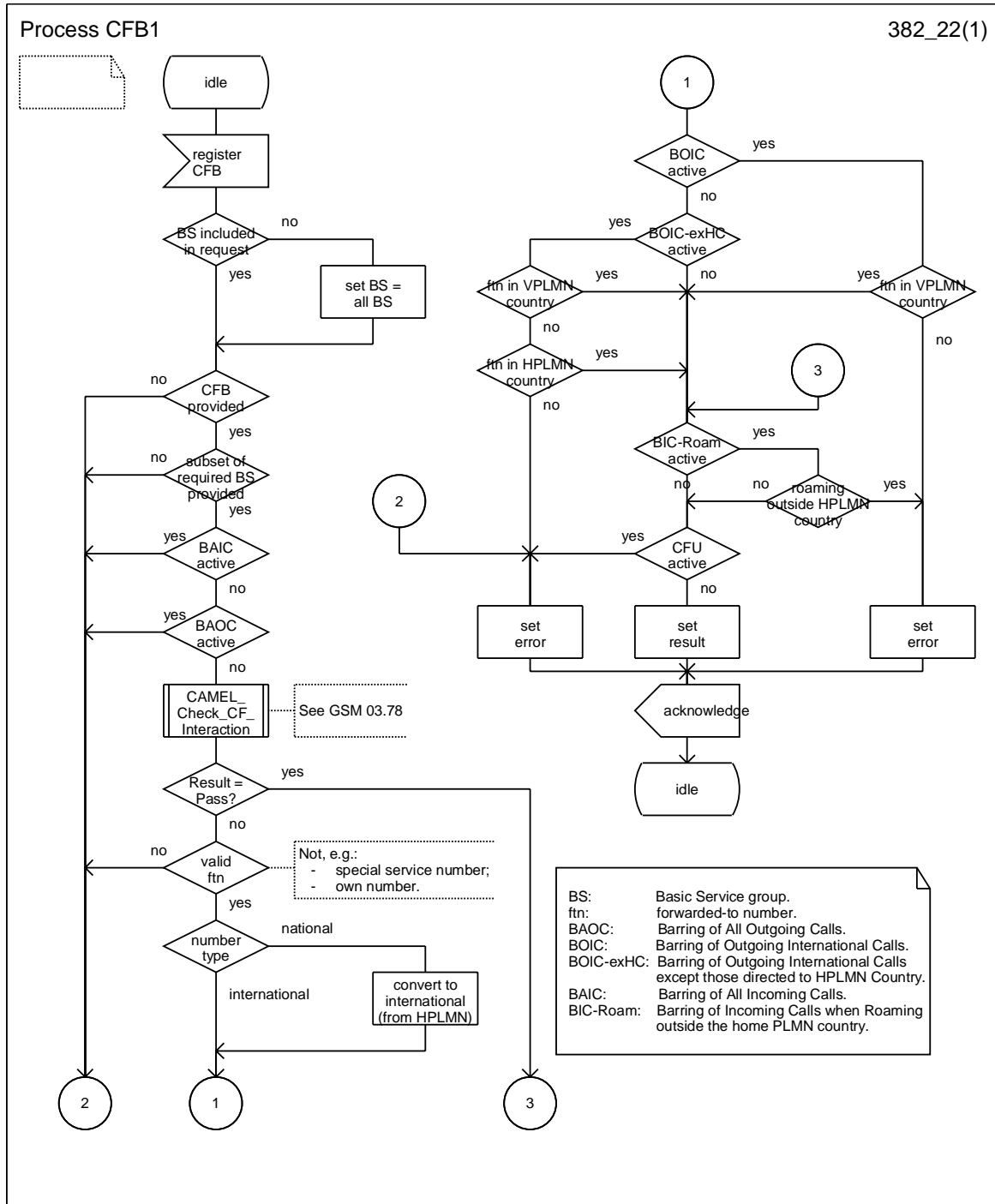

Figure 2.2: CFB1 Call forwarding on mobile subscriber busy registration process

2.1.2 Erasure

The same rules apply for the erasure of CFB as were described for CFU in subclause 1.1.2 above. However, no checks for interaction with other supplementary services are required for erasure of CFB, see figure 2.4.

The information flow for registration of CFB is shown in figure 2.3.

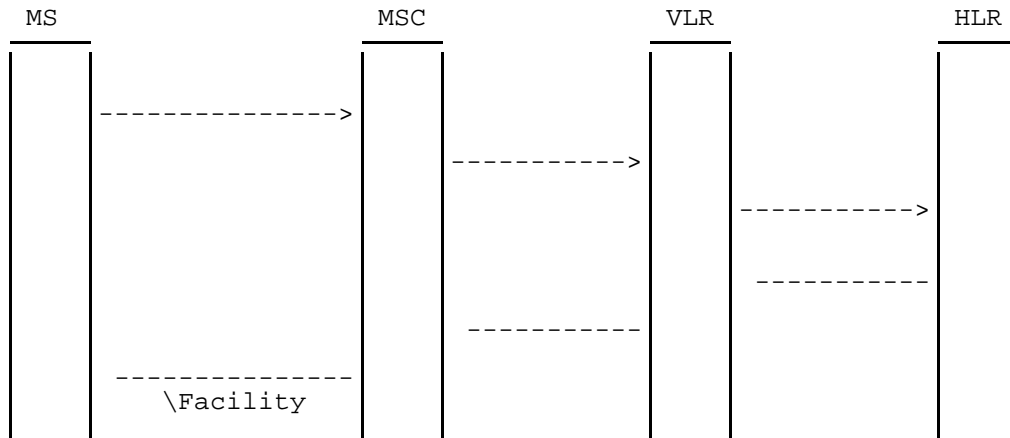
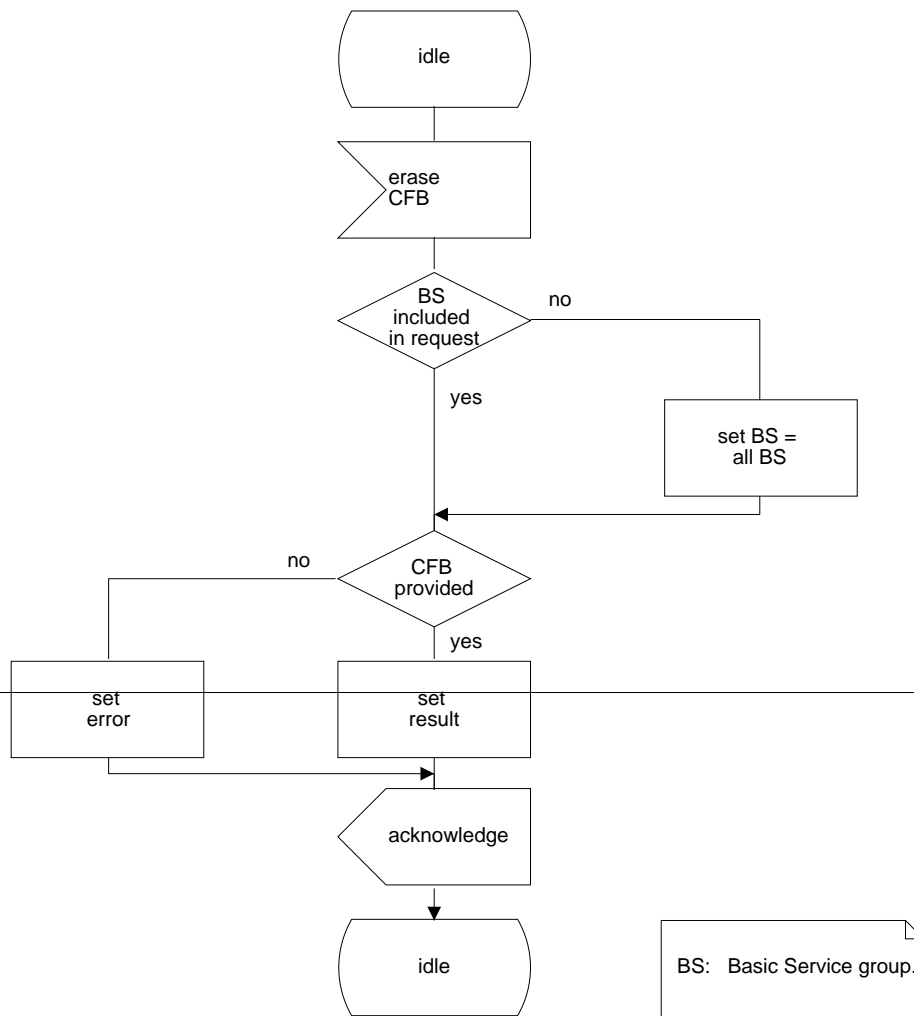

Figure 2.3: Erasure of call forwarding on mobile subscriber busy

Process CFB2

382_24(1)



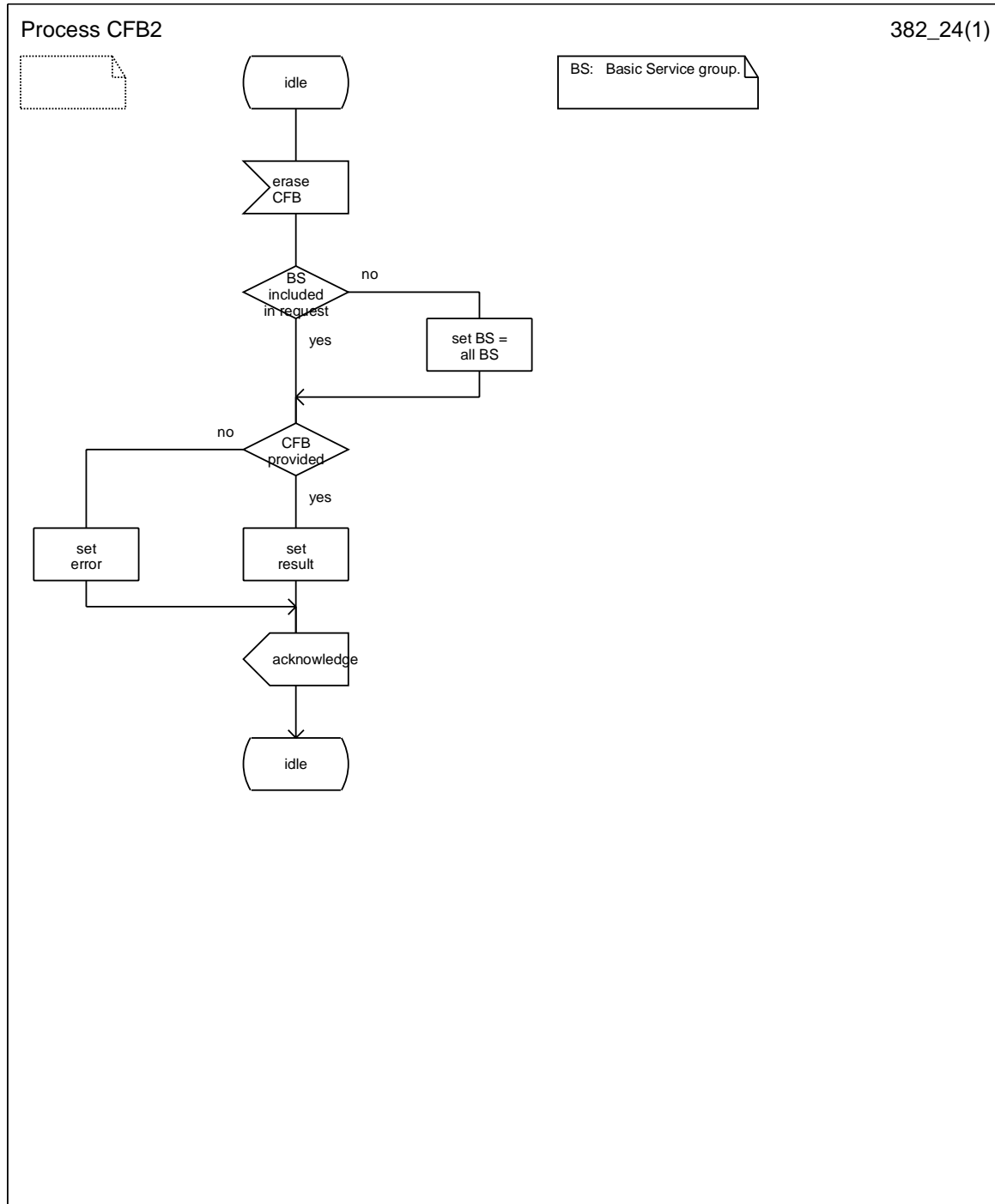

Figure 2.4: CFB2 Call forwarding on mobile subscriber busy erasure process

2.1.3 Activation

The same rules apply for the activation of CFB as were described for CFU in subclause 1.1.3 above, with the exception of the checking of interaction with other supplementary services. Basic activation of CFNRC is illustrated in figure 2.6.

Supplementary Service Interaction

Possible interaction situations between CFB and other supplementary services must then be checked. This is described in figure 2.6. Also see 3G TS 22.004 and 3G TS 22.082. For interaction between CFB and other supplementary services (ie not call barring or call forwarding services), the reader is referred to the respective technical specification for those supplementary services.

The information flow for activation of call forwarding on MS busy is shown in figure 2.5.

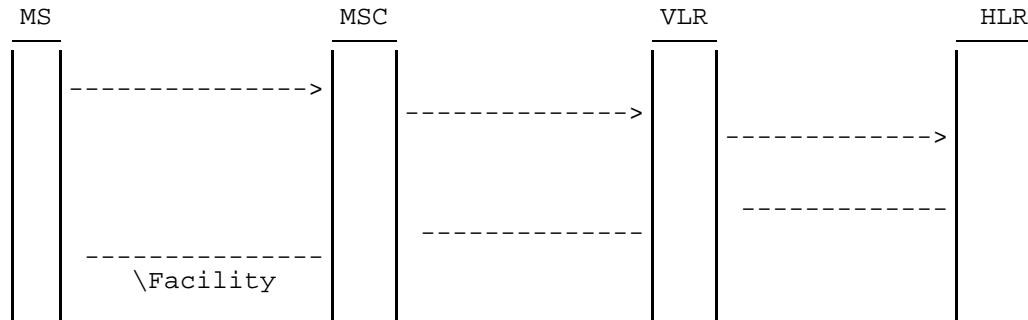
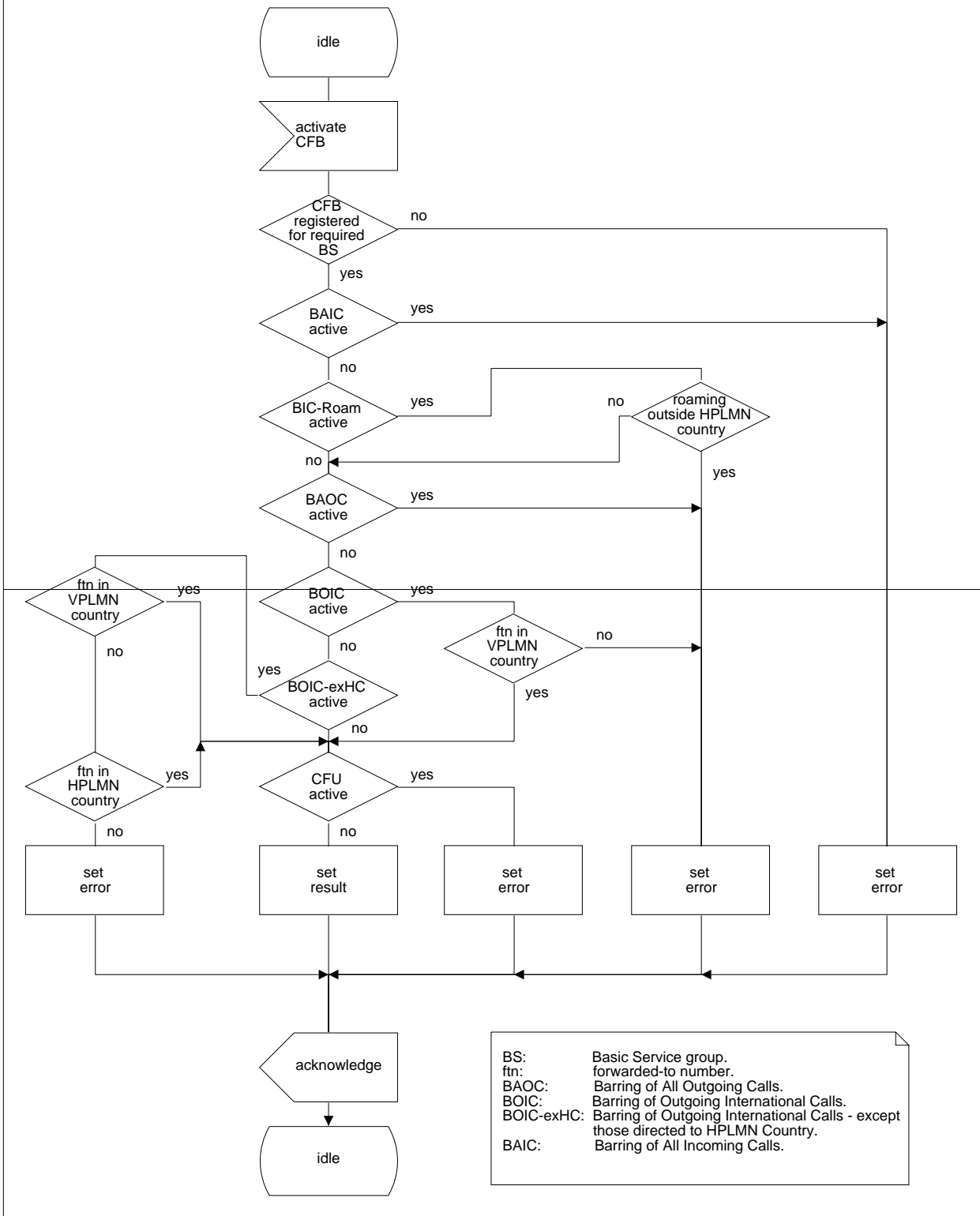

Figure 2.5: Activation of call forwarding on MS busy

Process CFB3

382_26(1)



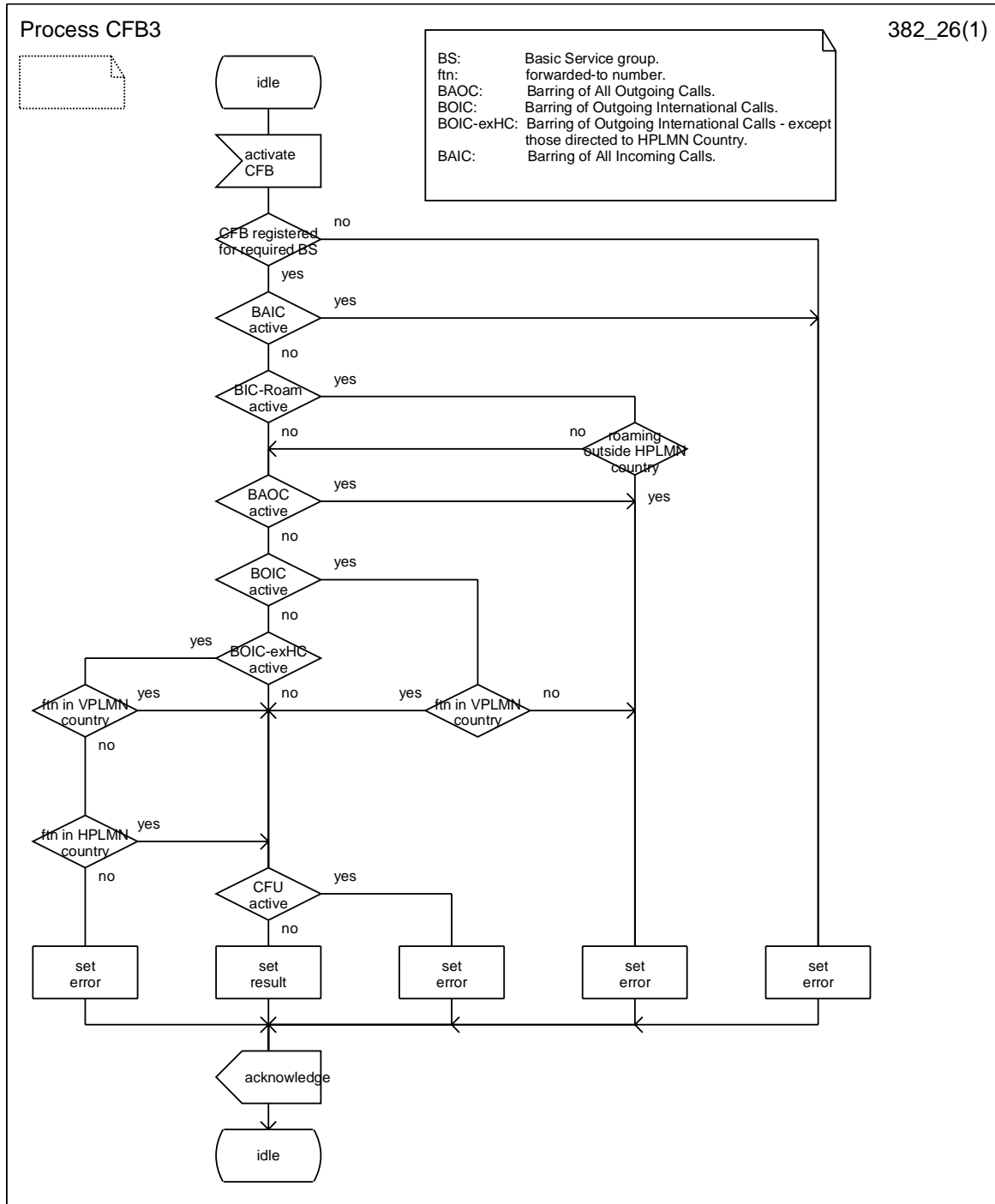

Figure 2.6: CFB3 Call forwarding on mobile subscriber busy activation process

2.1.4 Deactivation

The same rules apply for the deactivation of CFB as were described for CFU in subclause 1.1.4 above, see figure 2.8.

The information flow for deactivation of call forwarding on mobile subscriber busy is shown in figure 2.7.

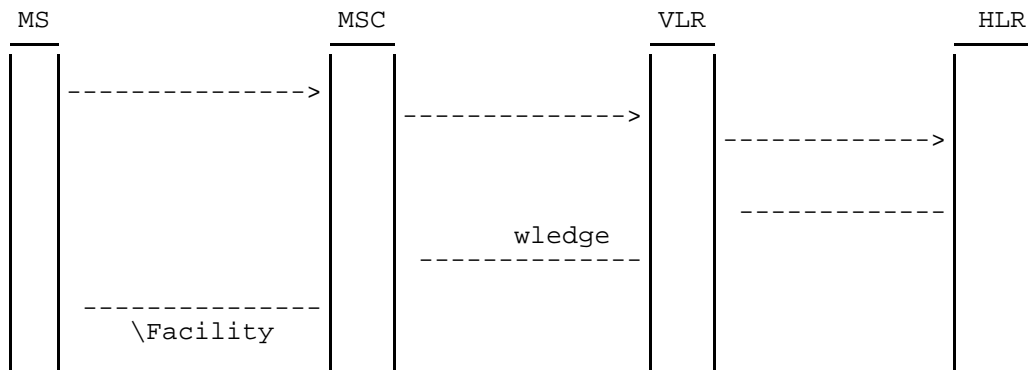
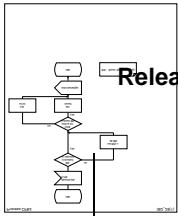

Figure 2.7: Deactivation of call forwarding on mobile subscriber busy



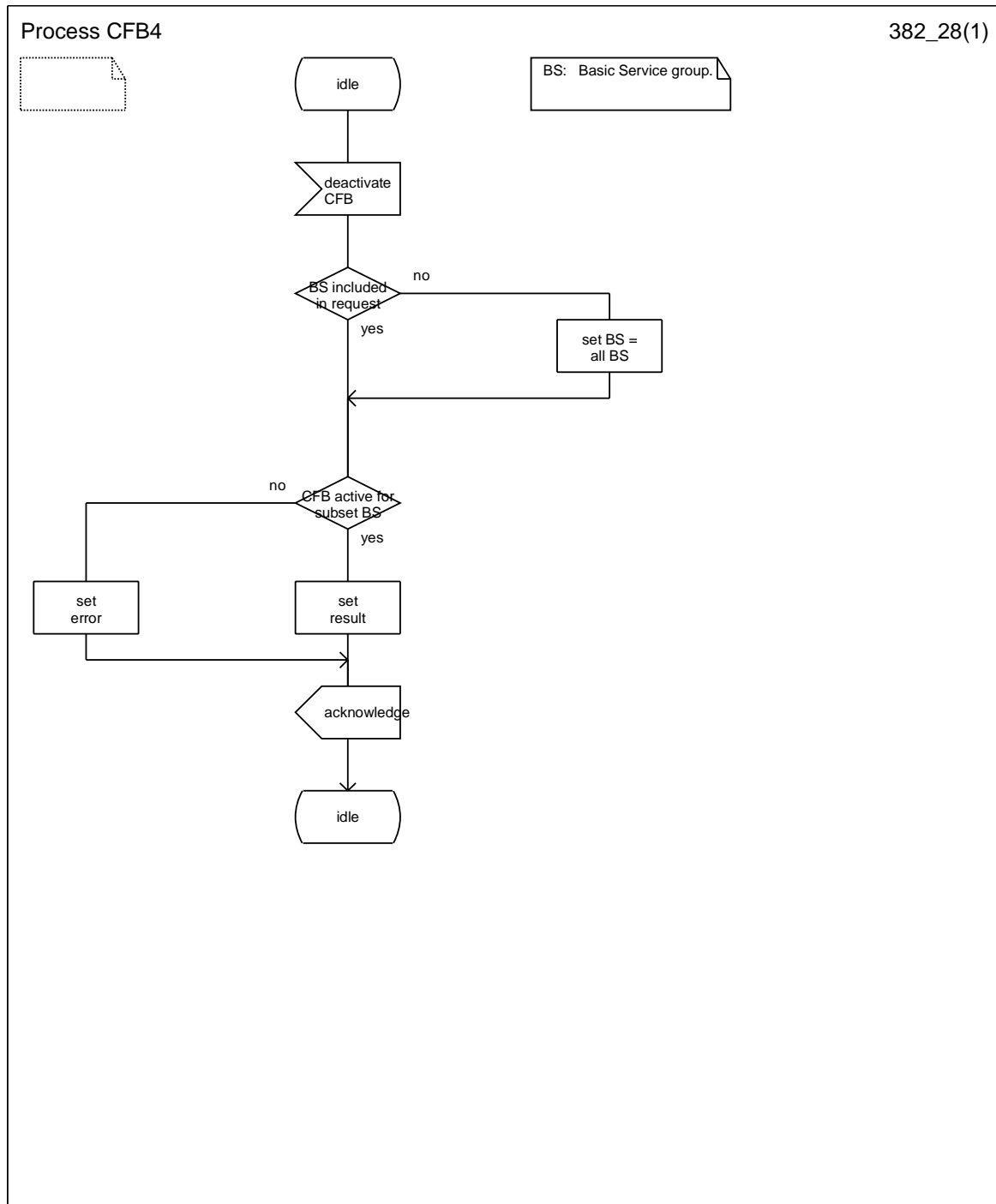

Figure 2.8: CFB4 Call forwarding on mobile subscriber busy deactivation process

2.1.5 Interrogation

Data request

The data request procedure enables the mobile subscriber to obtain information about the data stored in the PLMN. Interrogation of CFB is handled by the VLR which returns the required information or error to the MS, see figure 2.9.

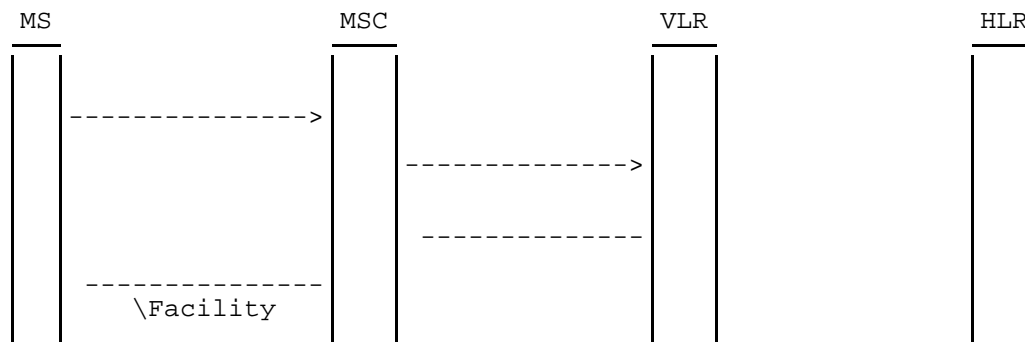

Figure 2.9: Interrogation of call forwarding on mobile subscriber busy

2.2 Functions and information flows

The following Mobile Additional Function has been identified for the PLMN:

MAF008

Call forwarding on mobile subscriber busy authorizations examination

The ability of a PLMN component to determine the authorizations relating to call forwarding on mobile subscriber busy. See figure 2.10.

Location: VLR.

The information flows for forwarding to fixed terminal and to mobile station are shown in figures 2.11 & 2.12 and 2.13 & 2.14 respectively.

Process MAF008

382_2A(1)

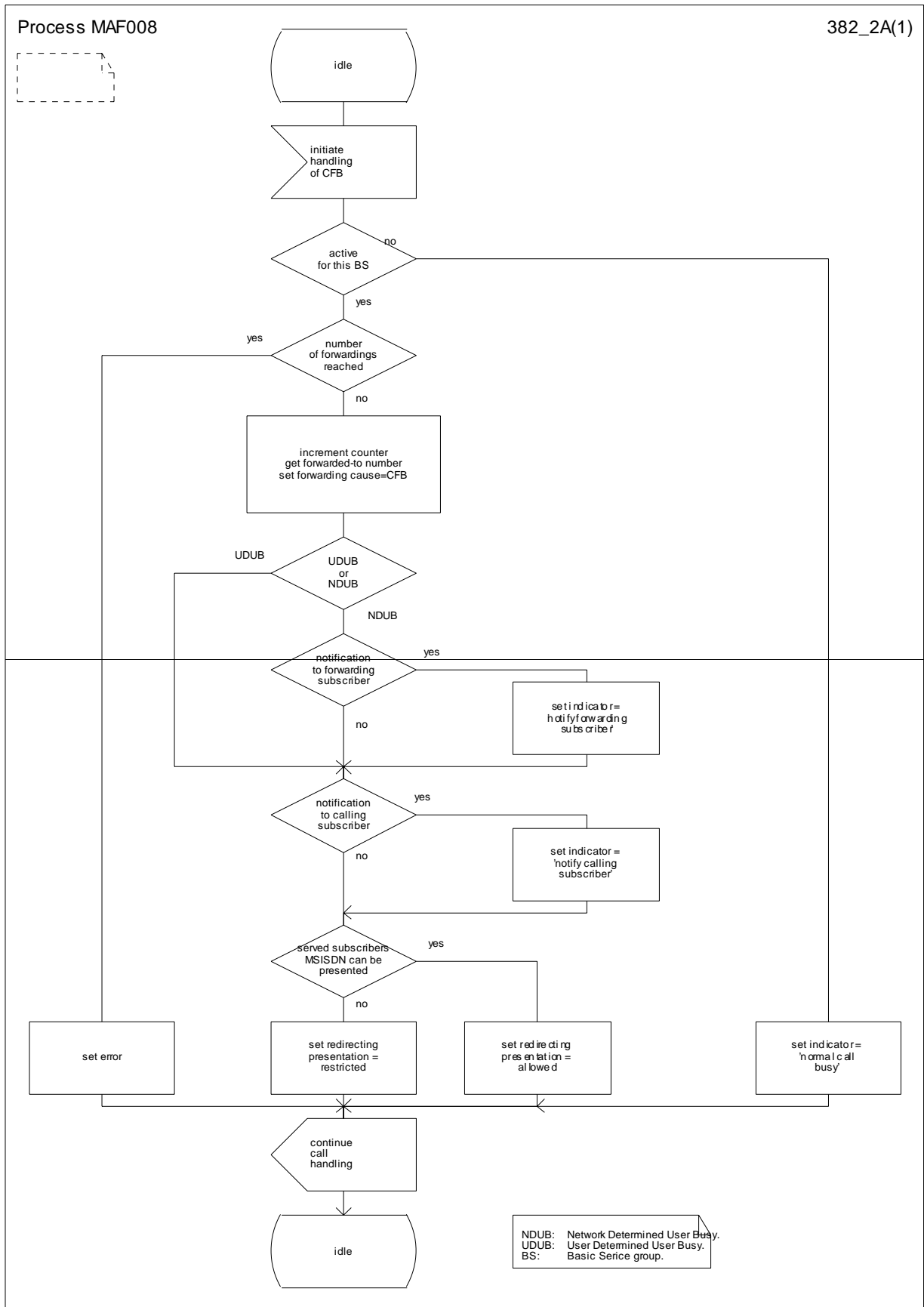

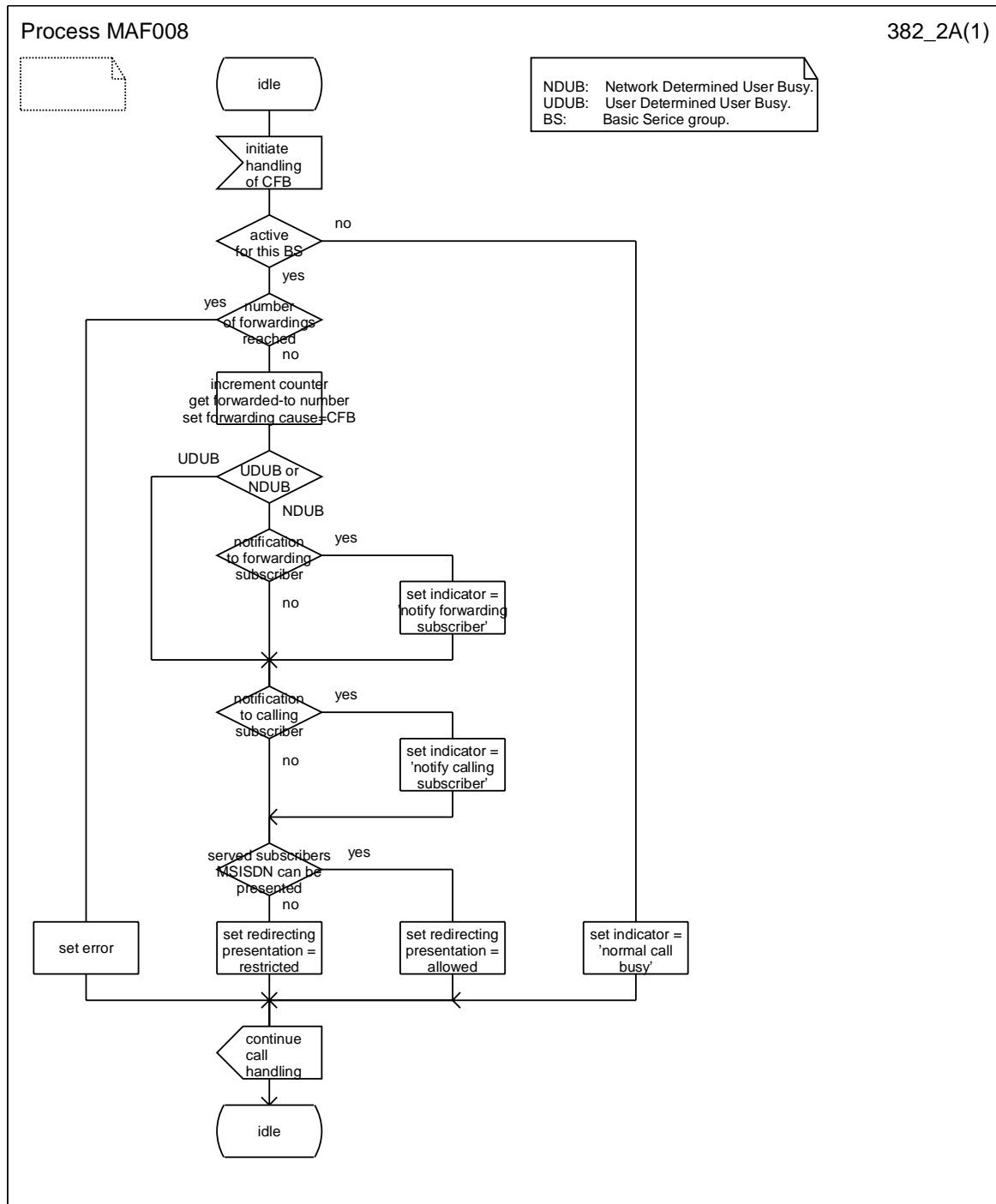
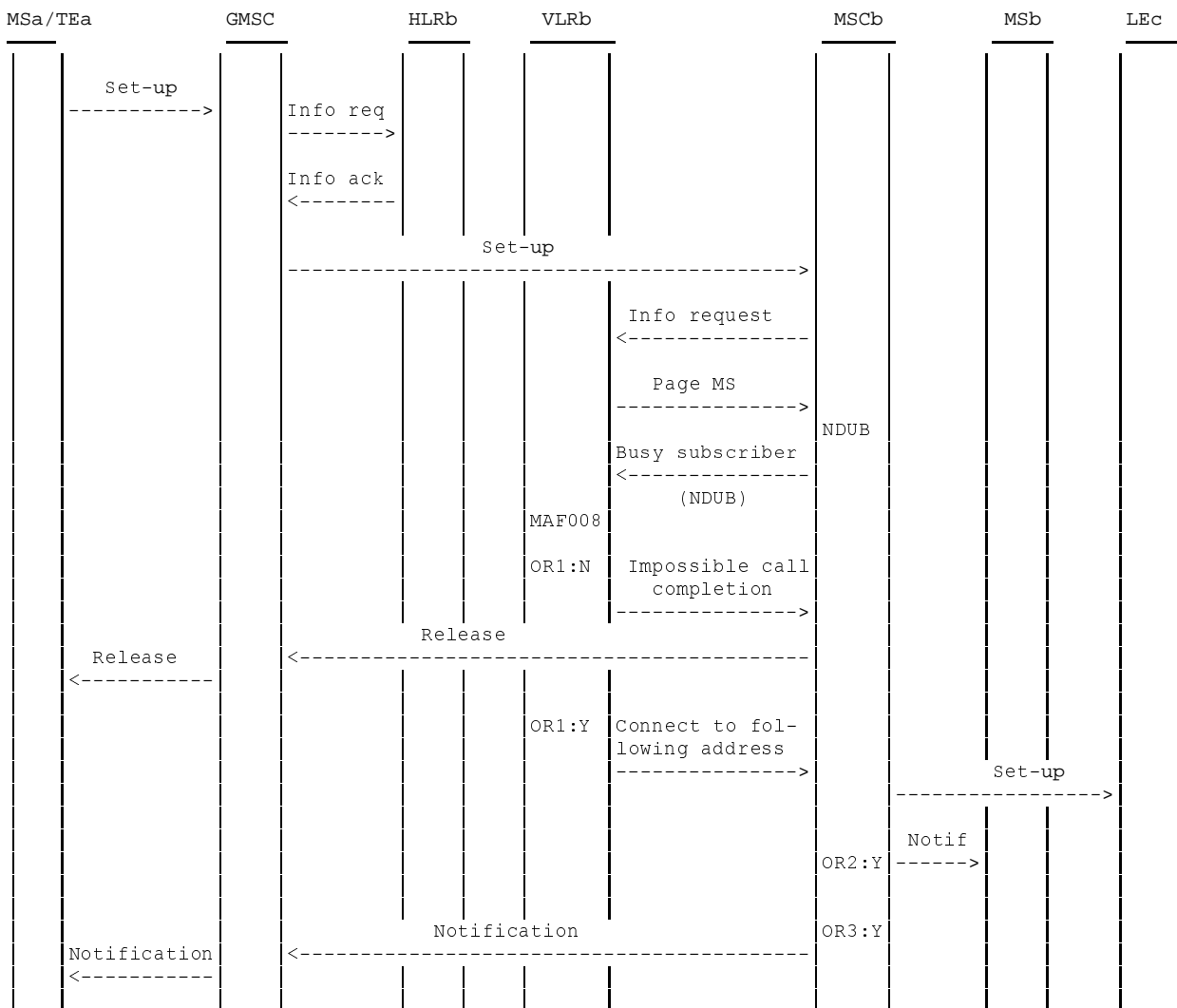
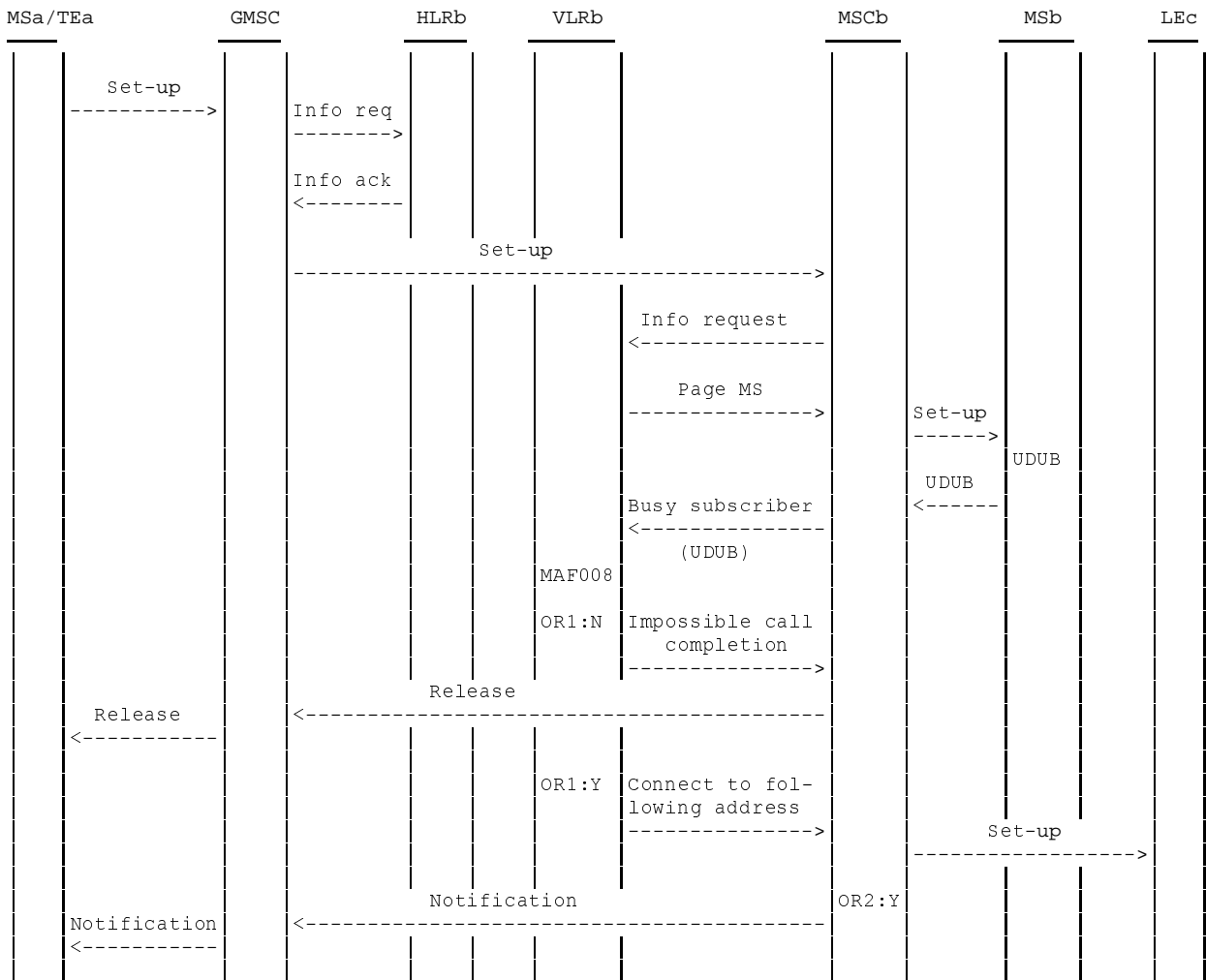

Figure 2.10: MAF008 Call forwarding on mobile subscriber busy authorisations examination (VLR)



NOTE: NDUB: Network Determined User Busy
 info: information Y: Yes
 req: request N: No
 ack: acknowledge
 notif: notification
 OR1: Call to be forwarded
 OR2: Notification to forwarding subscriber required
 OR3: Notification to calling subscriber required

Figure 2.11: Information flow for call forwarding on mobile subscriber busy (to fixed terminal) (NDUB)



NOTE: UDUB: User Determined User Busy
 info: information Y: Yes
 req: request N: No
 ack: acknowledge
 notif: notification
 OR1: Call to be forwarded
 OR2: Notification to calling subscriber required

Figure 2.12: Information flow for call forwarding on mobile subscriber busy (to fixed terminal) (UDUB)

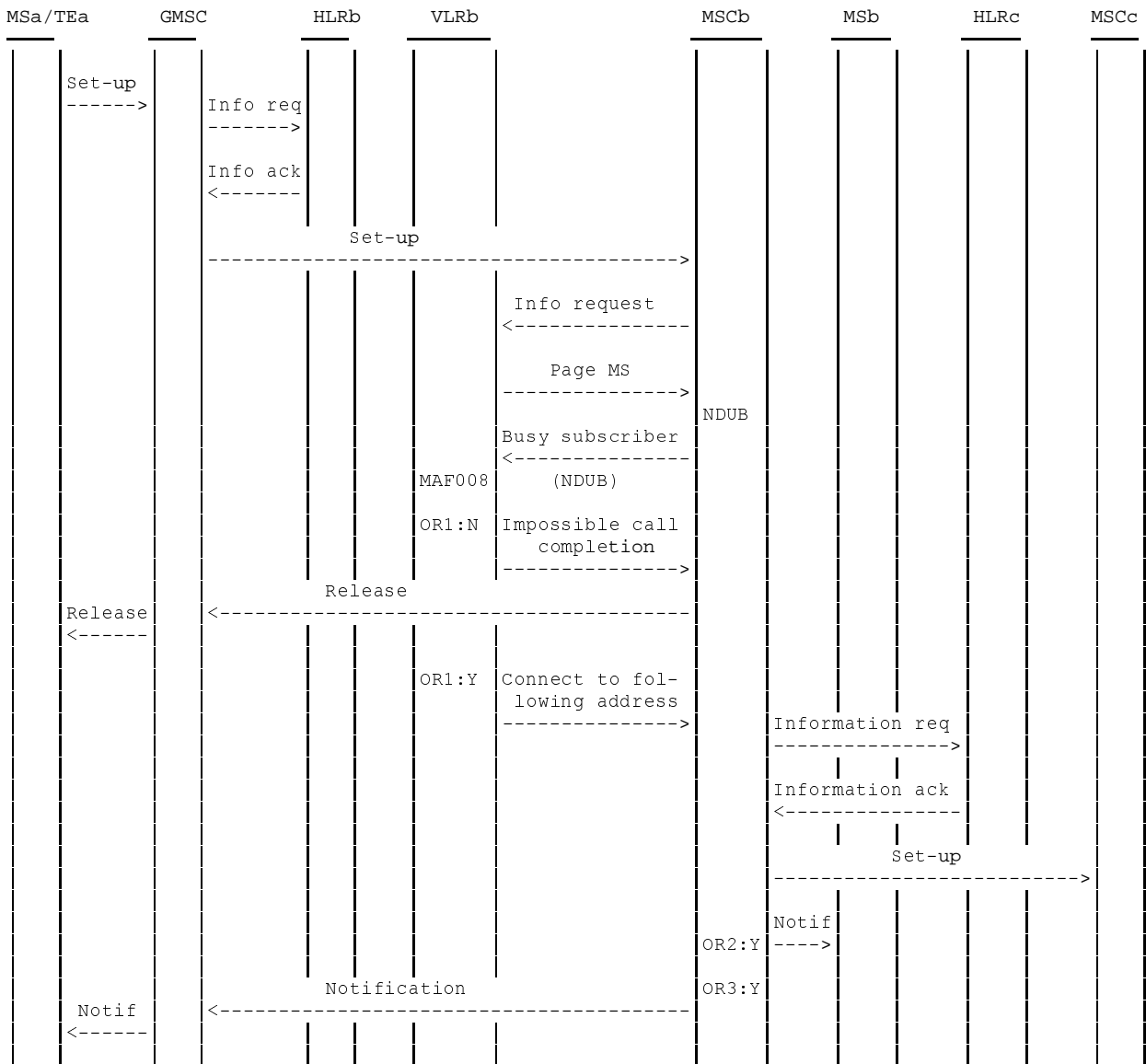

NOTE: NDUB: Network Determined User Busy
 info: information Y: Yes
 req: request N: No
 ack: acknowledge
 notif: notification
 OR1: Call to be forwarded
 OR2: Notification to forwarding subscriber required
 OR3: Notification to calling subscriber required

Figure 2.13: Information flow for call forwarding on mobile subscriber busy (to mobile station) (NDUB)

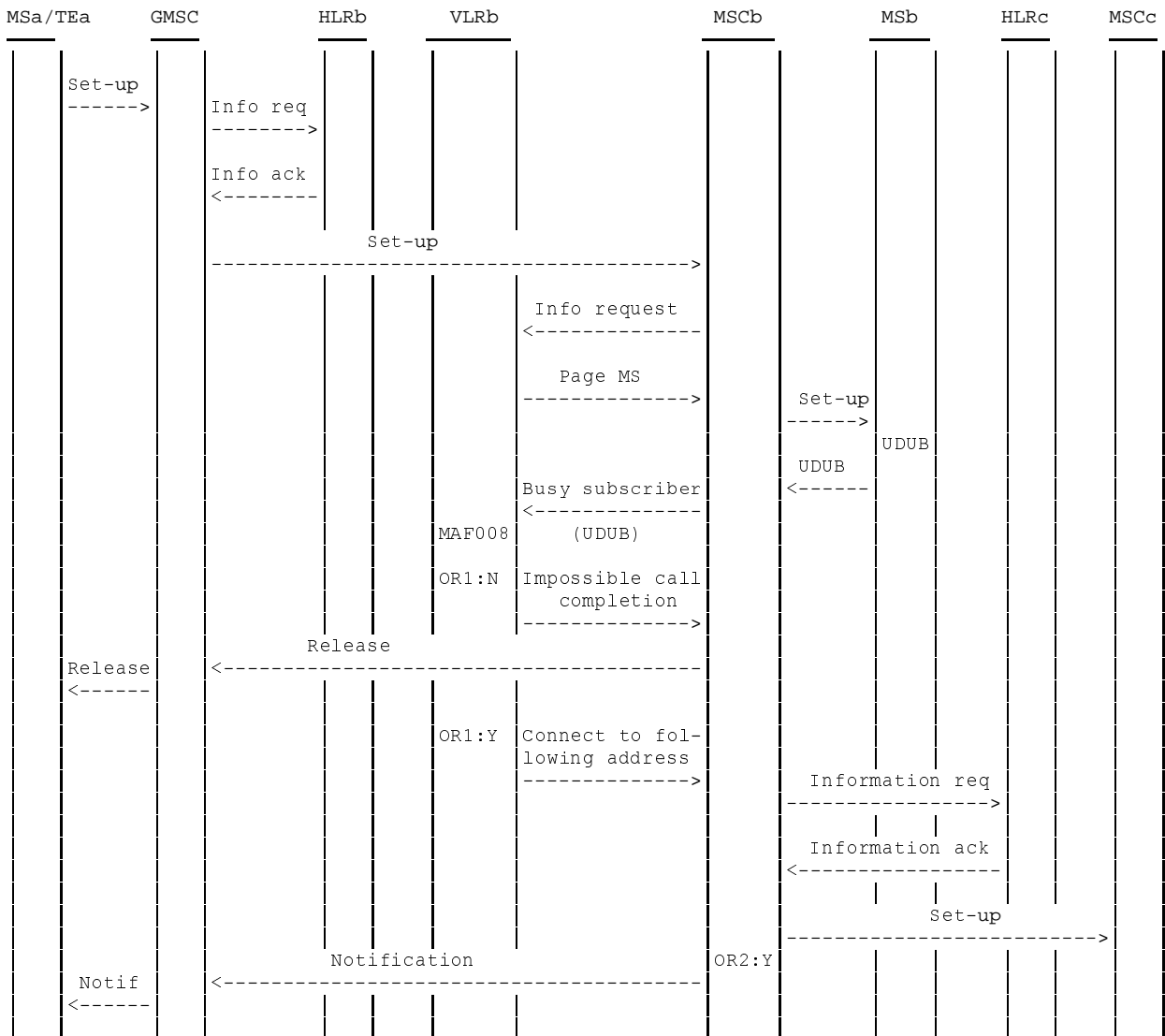

NOTE: UDUB: User Determined User Busy
 info: information Y: Yes
 req: request N: No
 ack: acknowledge
 notif: notification
 OR1: Call to be forwarded
 OR2: Notification to calling subscriber required

Figure 2.14: Information flow for call forwarding on mobile subscriber busy (to mobile station) (UDUB)

2.3 Information stored in the HLR

The following logical states are applicable for CFB (refer to 3G TS 23.011 for an explanation of the notation):

Provisioning State	Registration State	Activation State	HLR Induction State
(Not Provisioned,	Not Registered,	Not Active,	Not Induced)
(Provisioned,	Not Registered,	Not Active,	Not Induced)
(Provisioned,	Registered,	Not Active,	Not Induced)
(Provisioned,	Registered,	Active and Quiescent,	Not Induced)
(Provisioned,	Registered,	Active and Operative,	Not Induced)

The registration and activation state may be different for each applicable elementary basic service group.

The provisioning state shall be on a per subscriber basis, and hence the same for all basic service groups.

The HLR shall store:

- the state of CFB (which shall be one of the valid states listed above) for each applicable elementary basic service group;
- the subscription option "notification to the calling party" on a per subscriber basis;

This subscription option takes one of the following values:

- no notification;
- notification.
- the subscription option "notification to the forwarding party" on a per subscriber basis;

This subscription option takes one of the following values:

- no notification;
- notification.

the subscription option "MSISDN of the served subscriber can be presented to the forwarded-to subscriber" on a per subscriber basis;

This subscription option takes one of the following values:

- presentation restricted;
- presentation allowed.
- the registration parameter "forwarded-to number" (possibly including a forwarded-to sub-address) for each applicable elementary basic service group.

2.4 State transition model

The following figure shows the successful cases of transition between the applicable logical states of CFB. The state changes are either caused by actions of the service provider, the mobile user or the network.

Note that error cases are not shown in the diagram as they normally do not cause a state change. Additionally, some successful requests may not cause a state change. Hence, they are not shown in the diagram. The diagram only shows operations on an elementary basic service group.

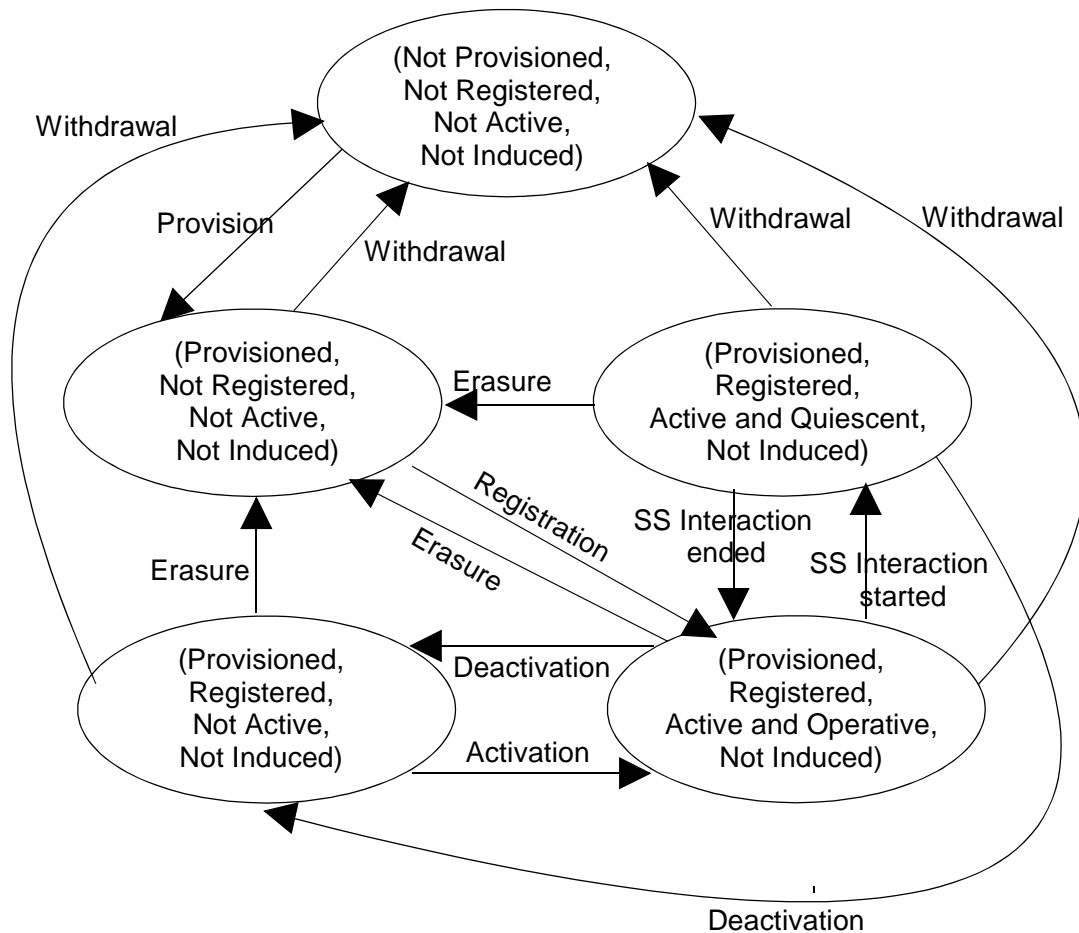

Figure 2.15: State transition model for CFB

2.5 Transfer of information from HLR to VLR

If the provisioning state for CFB is "Provisioned" then, when the subscriber registers on a VLR, the HLR shall send that VLR information about the logical state of CFB for all relevant elementary basic service groups.

If the registration state for CFB is "Registered" then, when the subscriber registers on a VLR, the HLR shall send that VLR the registration parameter "forwarded-to number" for all relevant elementary basic service groups and information about the subscription options "notification to the calling party", "notification to the forwarding party" and "MSISDN of the served subscriber can be presented to the forwarded-to subscriber".

If the logical state or the registration parameter "forwarded-to number" of CFB is changed while a subscriber is registered on a VLR then for the affected basic service groups, the HLR shall inform the VLR respectively of the new logical state or the new registration parameter of CFB.

If information about the subscription options "notification to the calling party" and "notification to the forwarding party" of CFB is changed while a subscriber is registered on a VLR and the registration state of CFB is "Registered" then the HLR shall inform the VLR of the new information about the subscription options of CFB.

2.6 Information stored in the VLR

For CFB the VLR shall store the service state information, the registration parameter "forward-to number" and the subscription options received from the HLR.

2.7 Handover

Handover will have no impact on the control procedure and the operation of the service.

2.8 Cross phase compatibility

2.8.1 MS, MSC, VLR or HLR only support Phase 1 control of SS by the subscriber

In response to a CFB interrogation request, if the MS or any network element involved is of Phase 1, only information concerning basic service groups for which the activation state has the value "Active and Operative" will be returned. This means that the subscriber will not be aware that the forwarded to number is registered if CFB is deactivated or active (quiescent). A subaddress (if registered) will not be included.

Note that if any network element involved is of Phase 1, CFB Registration requests which use a subaddress and all CFB Activation and Deactivation requests will be rejected, as these are not specified in Phase 1.

2.8.2 HLR only supports Phase 1 updating of subscriber information

If the VLR receives the SS-Status parameter from a Phase 1 HLR it shall act if it has received the SS-Status parameter with the values shown in the following:

- | | |
|----------------------------|---|
| 1) Registered, Activated | => P bit = 1, R bit = 1, A bit = 1, Q bit = 0; |
| 2) Registered, Deactivated | => P bit = 1, R bit = 1, A bit = 0, Q bit = 0 or 1; |
| 3) Erased | => P bit = 1, R bit = 0, A bit = 0, Q bit = 0 or 1. |

2.8.3 VLR only supports Phase 1 updating of subscriber information

When passing CFB information to a Phase 1 VLR, the HLR shall send the service state information in a form which the VLR can accept, based on the logical state held in the HLR, as follows:

- | | |
|---|-----------------------------|
| 1) (Provisioned, Not Registered, Not Active, Not Induced) | => Erased, Deactivated; |
| 2) (Provisioned, Registered, Not Active, Not Induced) | => Registered, Deactivated; |
| 3) (Provisioned, Registered, Active and Operative, Not Induced) | => Registered, Activated; |
| 4) (Provisioned, Registered, Active and Quiescent, Not Induced) | => Registered, Deactivated. |

The HLR shall not pass a subaddress to a Phase 1 VLR.

2.8.4 VLR only supports Phase 1 call handling

When a call is forwarded on busy, as the HLR does not pass the subaddress to the VLR, calls shall be forwarded without the subaddress.

2.8.5 VLR does not support CAMEL or supports CAMEL Phase 1 only

When passing CFB information to a VLR not supporting CAMEL or supporting CAMEL Phase 1 only, the HLR shall send the registration parameter "forwarded-to number" only if it is registered in a format which the VLR can accept, i.e. international format.

If the registration state for CFB is "Registered" and the forwarded-to number is registered in a format other than international, then when updating a VLR not supporting CAMEL or supporting CAMEL Phase 1 only the HLR shall modify the service state information of CFB as follows.

- 1) (Provisioned, Registered, Not Active, Not Induced)
 - => (Provisioned, Not Registered, Not Active, Not Induced)
- 2) (Provisioned, Registered, Active and Operative, Not Induced)
 - => (Provisioned, Not Registered, Not Active, Not Induced)
- 3) (Provisioned, Registered, Active and Quiescent, Not Induced)
 - => (Provisioned, Not Registered, Not Active, Not Induced)

According to the definitions in subclause 2.5 no forwarded-to number will be passed to the VLR in these cases. The modification of the service state information sent to the VLR shall have no impact on the service state information stored in the HLR.

If the VLR supports Phase 1 updating of subscriber information only, a further translation of the service state information as defined in subclause 2.8.3 shall be performed by the HLR.

2.9 Contents of messages

The same additions apply for CFB as for CFU, see subclause 1.9. The following additions are specific to CFB.

2.9.1 Messages on the B interface (MSC-VLR)

2.9.1.1 Send Info For Incoming Call ack

This message is specified in 3G TS 23.018.

Send Info For Incoming Call ack contains the following amendment to the Forwarded-to number IE, specific to Long Forwarded-to Numbers:

Information element name	Required	Description
Forwarded-to number	M	Number of the C subscriber.

2.9.2 Messages on the D interface (VLR-HLR)

2.9.2.1 Insert Subscriber Data

This message corresponds to the MAP-INSERT-SUBSCRIBER-DATA service specified in 3G TS 29.002.

Insert Subscriber Data contains the following IE specific to Long Forwarded-to Numbers:

Information element name	Required	Description
Long forwarded-to number	C	Shall be present if the subscriber has a long forwarded-to number registered; otherwise shall be absent.

2.9.2.2 Insert Subscriber Data ack

This message corresponds to the MAP-INSERT-SUBSCRIBER-DATA service specified in 3G TS 29.002.

Insert Subscriber Data ack contains the following IE specific to Long Forwarded-to Numbers:

Information element name	Required	Description
Long FTN supported	C	Shall be present if the VLR supports Long Forwarded-to Numbers; otherwise shall be absent.

C Conditional (The IE shall be sent, if available)

2.9.3 Messages on the E interface (VMSC-GMSC)

2.9.3.1 Resume Call Handling

This message is specified in 3G TS 23.079.

Resume Call Handling contains the following amendment to the Forwarded-to number IE and an additional IE specific to Long Forwarded-to Numbers:

Information element name	Required	Description
Forwarded-to number	C	E.164 number of the C subscriber. Shall be present if the VMSC does not support Long Forwarded-to Numbers; otherwise shall be absent.
Long forwarded-to number	C	Number of the C subscriber. Shall be present if the VMSC supports Long Forwarded-to Numbers; otherwise shall be absent.

2.9.4 Messages on the MSC internal interface

2.9.4.1 Perform Call Forwarding

This message is specified in 3G TS 23.018.

Perform Call Forwarding contains the following amendment to the Forwarded-to number IE specific to Long Forwarded-to Numbers:

Information element name	Required	Description
Forwarded-to number	M	Number of the C subscriber.

2.9.4.2 Perform Call Forwarding ack

This message is specified in 3G TS 23.018.

Perform Call Forwarding ack contains the following amendment to the Forwarded-to number IE specific to Long Forwarded-to Numbers:

Information element name	Required	Description
Forwarded-to number	M	Number of the C subscriber. NOTE: This number may be different from the Forwarded-to number received in the Perform Call Forwarding, as a result of CAMEL handling.

2.10 Support of Long Forwarded-to Numbers

2.10.1 MS does not support Long Forwarded-to Numbers

The handling for CFB is the same as that for CFU, see subclause 1.10.1.

2.10.2 HLR does not support Long Forwarded-to Numbers

The handling for CFB is the same as that for CFU, see subclause 1.10.2.

2.10.3 GMSC does not support Long Forwarded-to Numbers

The handling for CFB is the same as that for CFU, see subclause 1.10.3.

2.10.4 MSC/VLR does not support Long Forwarded-to Numbers

The VLR shall indicate whether it supports Long Forwarded-to Numbers in the Update Location message to the HLR. If the VLR does not support Long Forwarded-to Numbers, as a network option the HLR may:

- Send an Insert Subscriber Data message containing the Forwarded-to number parameter to the VLR with an alternative forwarded-to number (containing a maximum of 15 digits).
- If the registration state for CFB is "Registered" and the forwarded-to number contains more than 15 digits, the HLR shall send the VLR the following service state information:

(Provisioned, Not Registered, Not Active, Not Induced)

For an MT call, if the following conditions are met then the HLR shall include the Forwarding interrogation required parameter in the first Send Routing Info ack:

- The GMSC supports Optimal Routeing and Long Forwarded-to Numbers;
- The MSC/VLR does not support Long Forwarded-to Numbers;
- CFB is active and operative;
- A long forwarded-to number is registered for CFB.

According to the rules of Optimal Routeing, when the GMSC receives a Resume Call Handling message from the MSC/VLR, it shall send a second Send Routing Info message to the HLR allowing the HLR to insert the correct long forwarded-to number.

3 Call forwarding on no reply

3.1 Handling of call forwarding on no reply

3.1.1 Registration

The same rules apply for the registration of Call Forwarding on No Reply as were described for Call Forwarding Unconditional in subclause 1.1.1 above, with the exceptions described below. Basic registration of information is illustrated in figure 3.2.

The No Reply Condition Timer

If a value for the no reply condition timer is not included in the registration request received from the MS, then the previous value set by the mobile user or the network operator applies.

Supplementary Service Interaction

Possible interaction situations between CFNRy and other supplementary services must then be checked. This is described in figure 3.2. Also see 3G TS 22.004 and 3G TS 22.082. For interaction between CFNRy and other supplementary services (ie not call barring or call forwarding services), the reader is referred to the respective technical specification for those supplementary services.

Interaction with CAMEL Phase 2 or higher

Possible interaction between CFNRy and CAMEL Phase 2 or higher is described in figure 3.2. If CAMEL Phase 2 or higher is not supported in the HLR, processing continues from the "No" exit of the test "Result=Pass".

The information flow for registration of call forwarding on no reply is shown in figure 3.1.

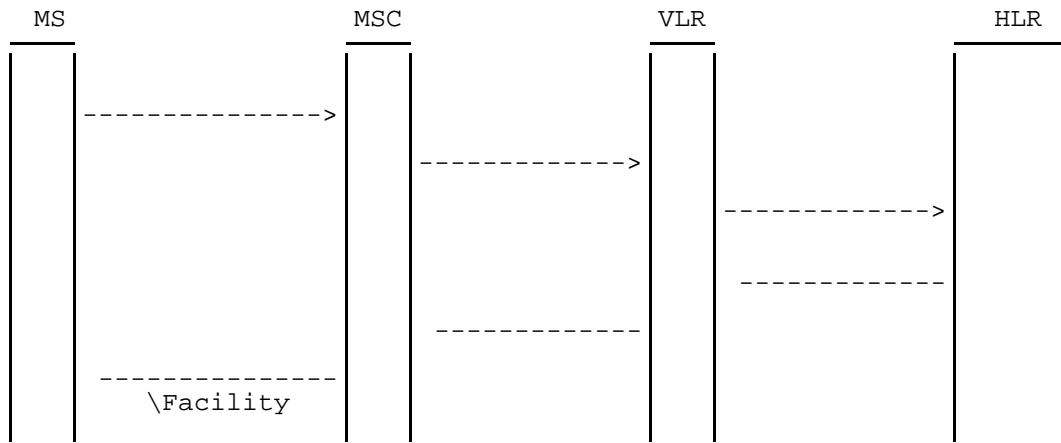
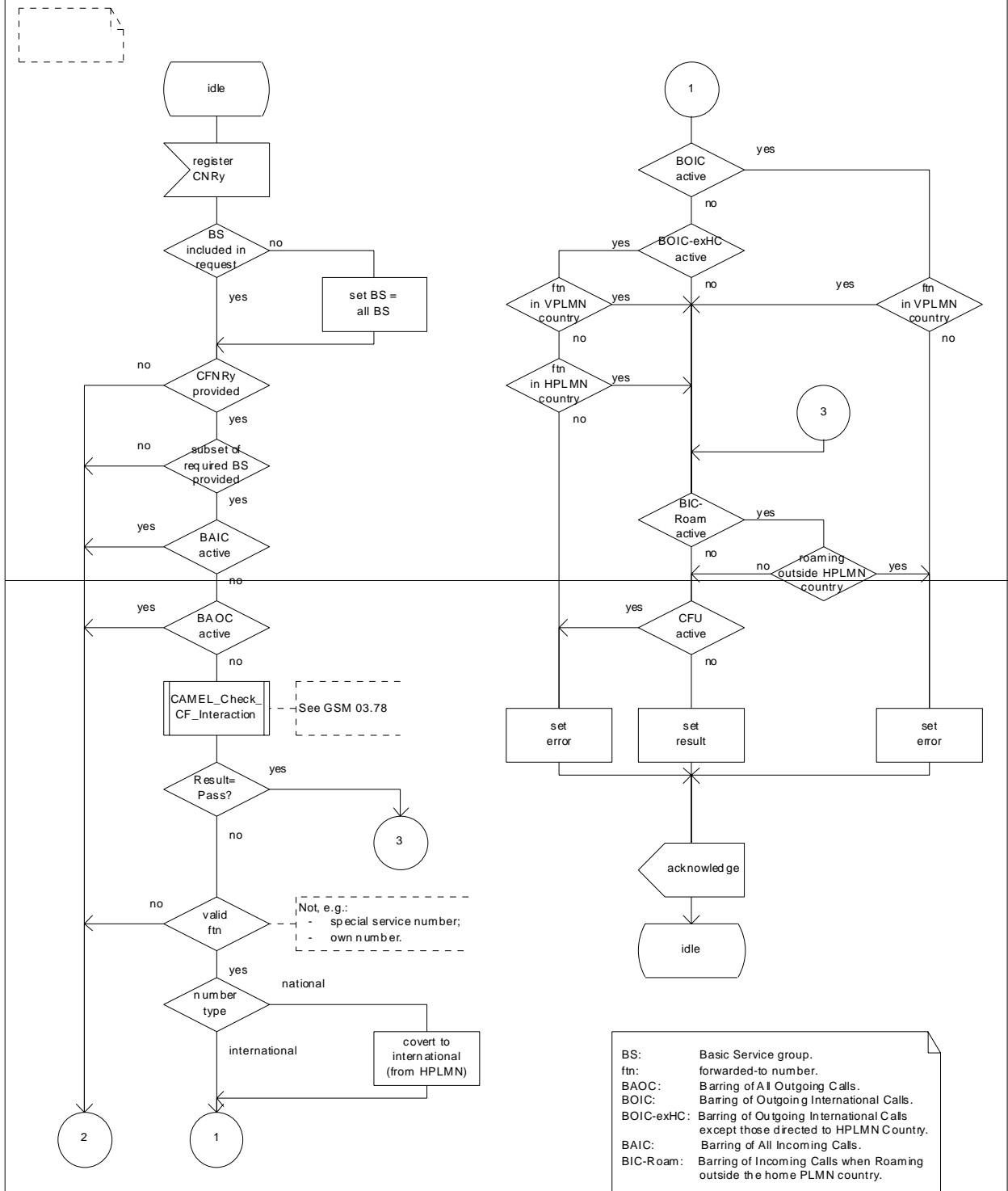

Figure 3.1: Registration of call forwarding on no reply

Process CFNRy1

382_32(1)



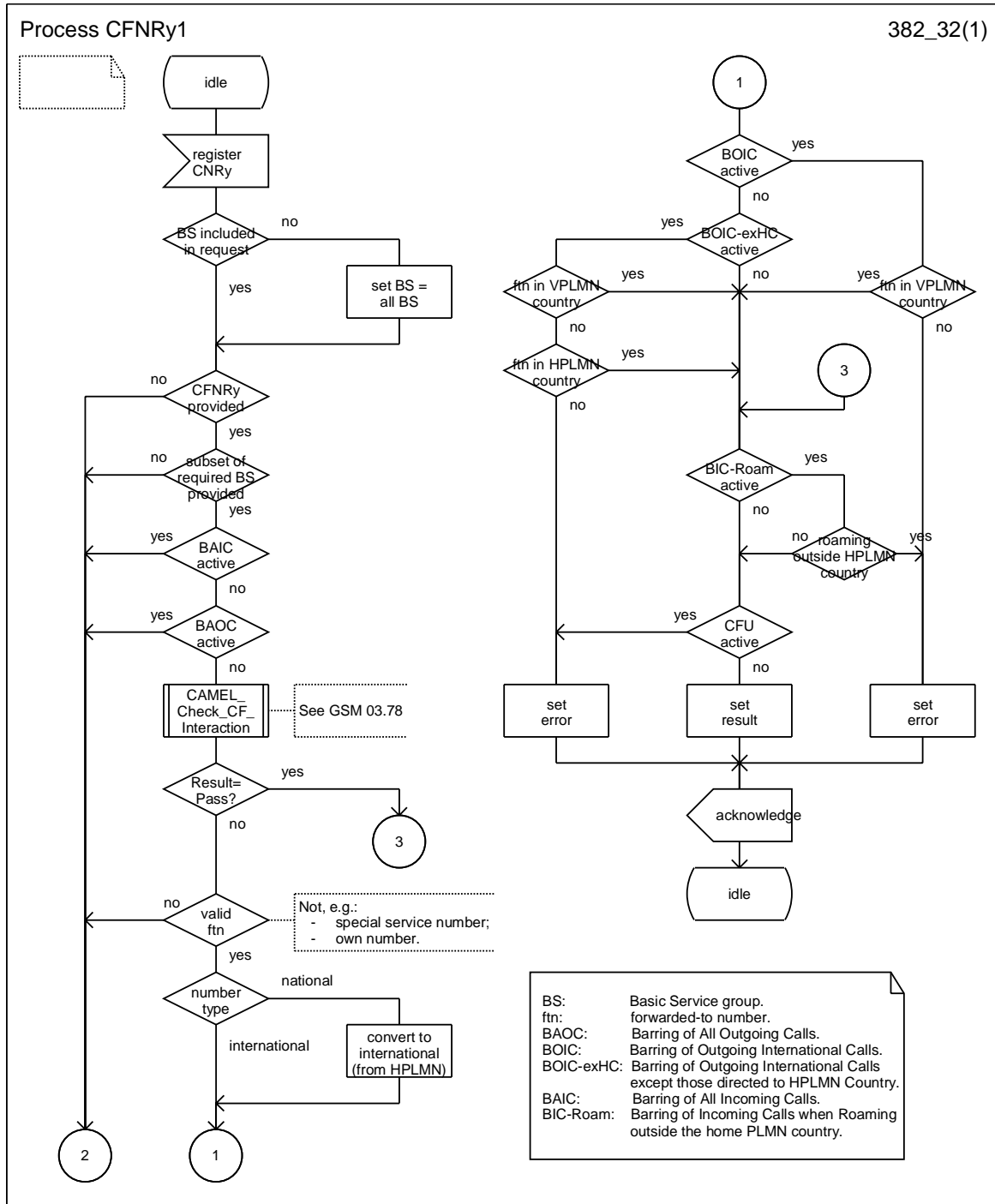

Figure 3.2: CFNRy1 Call forwarding on no reply registration process

3.1.2 Erasure

The same rules apply for the erasure of Call Forwarding on No Reply as were described for Call Forwarding Unconditional in subclause 1.1.2 above. However, no checks for interaction with other supplementary services are required for erasure of CFNRy, see figures 3.3 and 3.4.

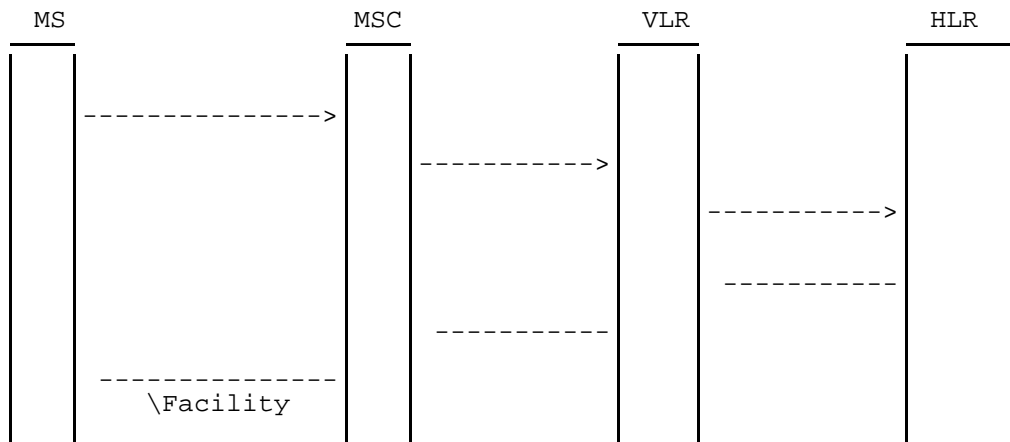
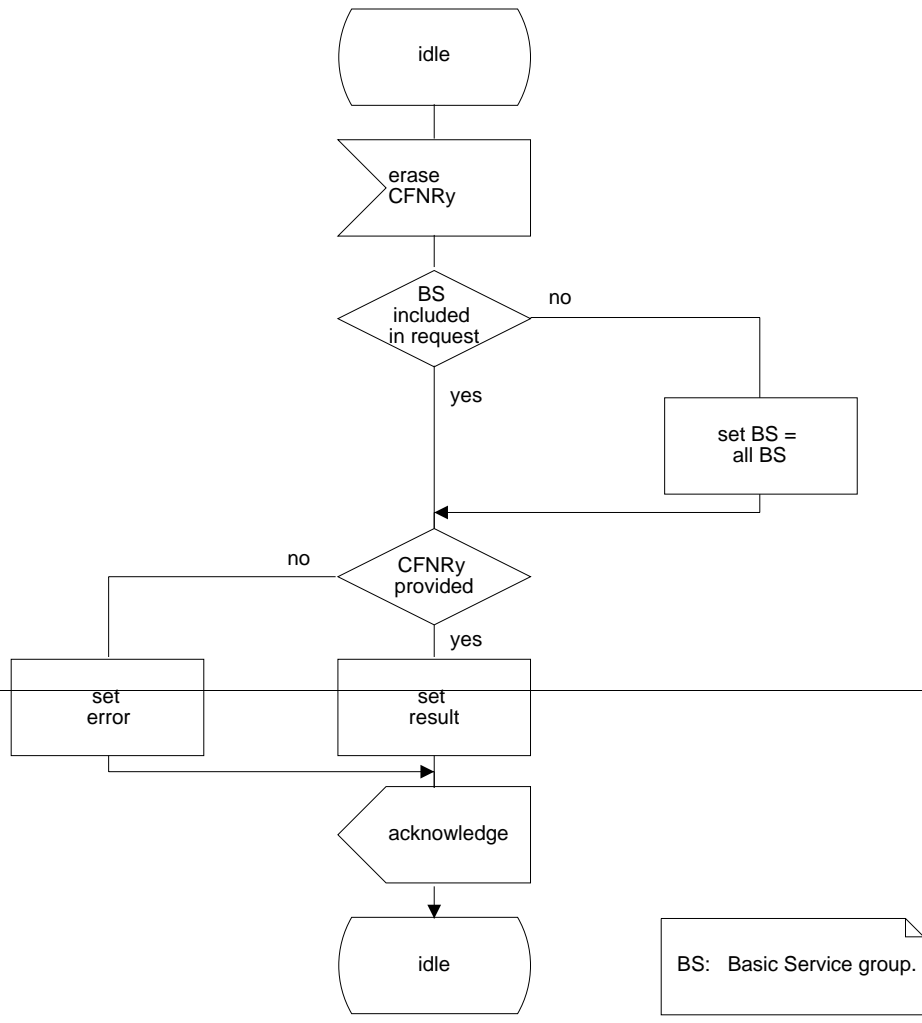

Figure 3.3: Erasure of call forwarding on no reply

Process CFNRy2

382_34(1)



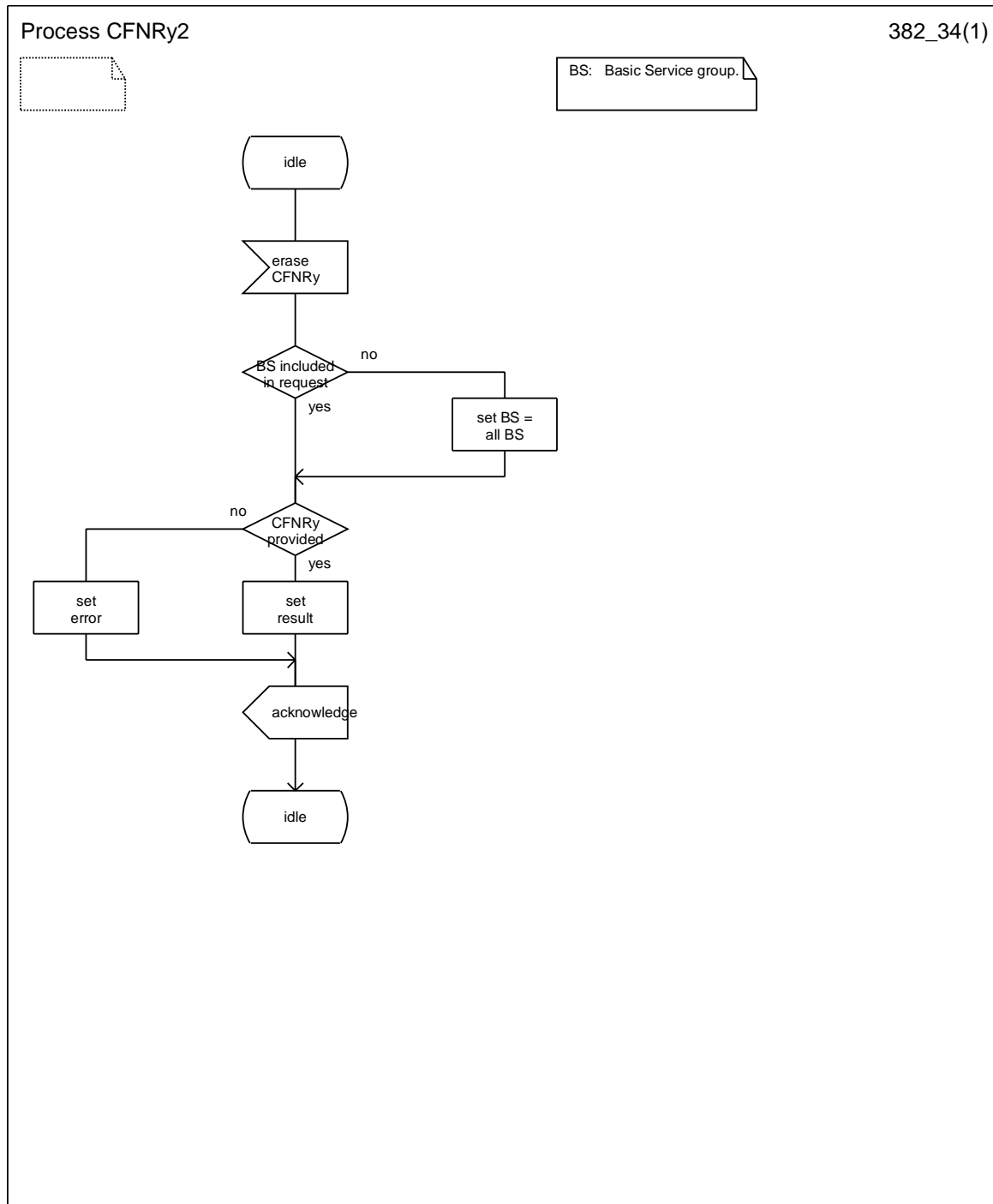

Figure 3.4: CFNRy2 Call forwarding on no reply erasure process

3.1.3 Activation

The same rules apply for the activation of Call Forwarding on No Reply as were described for Call Forwarding Unconditional in subclause 1.1.3 above, with the exception of the checking of interaction with other supplementary services. Basic activation of CFNRy is illustrated in figure 3.6.

Supplementary Service Interaction

Possible interaction situations between CFNRy and other supplementary services must then be checked. This is described in figure 3.6. Also see 3G TS 22.004 and 3G TS 22.082. For interaction between CFNRy and other supplementary services (ie not call barring or call forwarding services), the reader is referred to the respective technical specification for those supplementary services.

The information flow for activation of CFNRy is shown in figure 3.5.

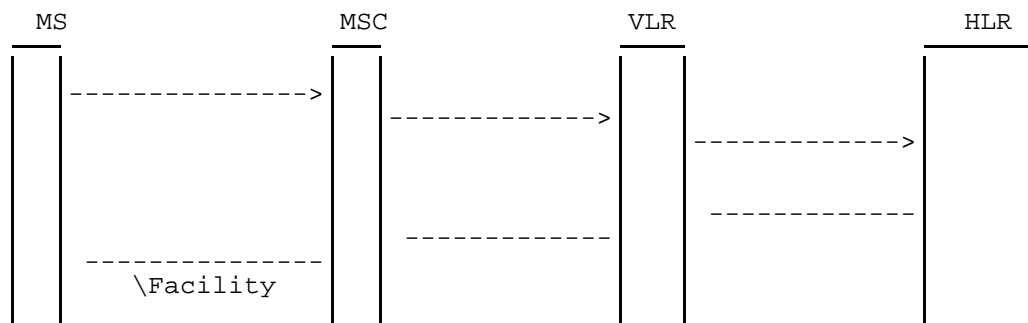
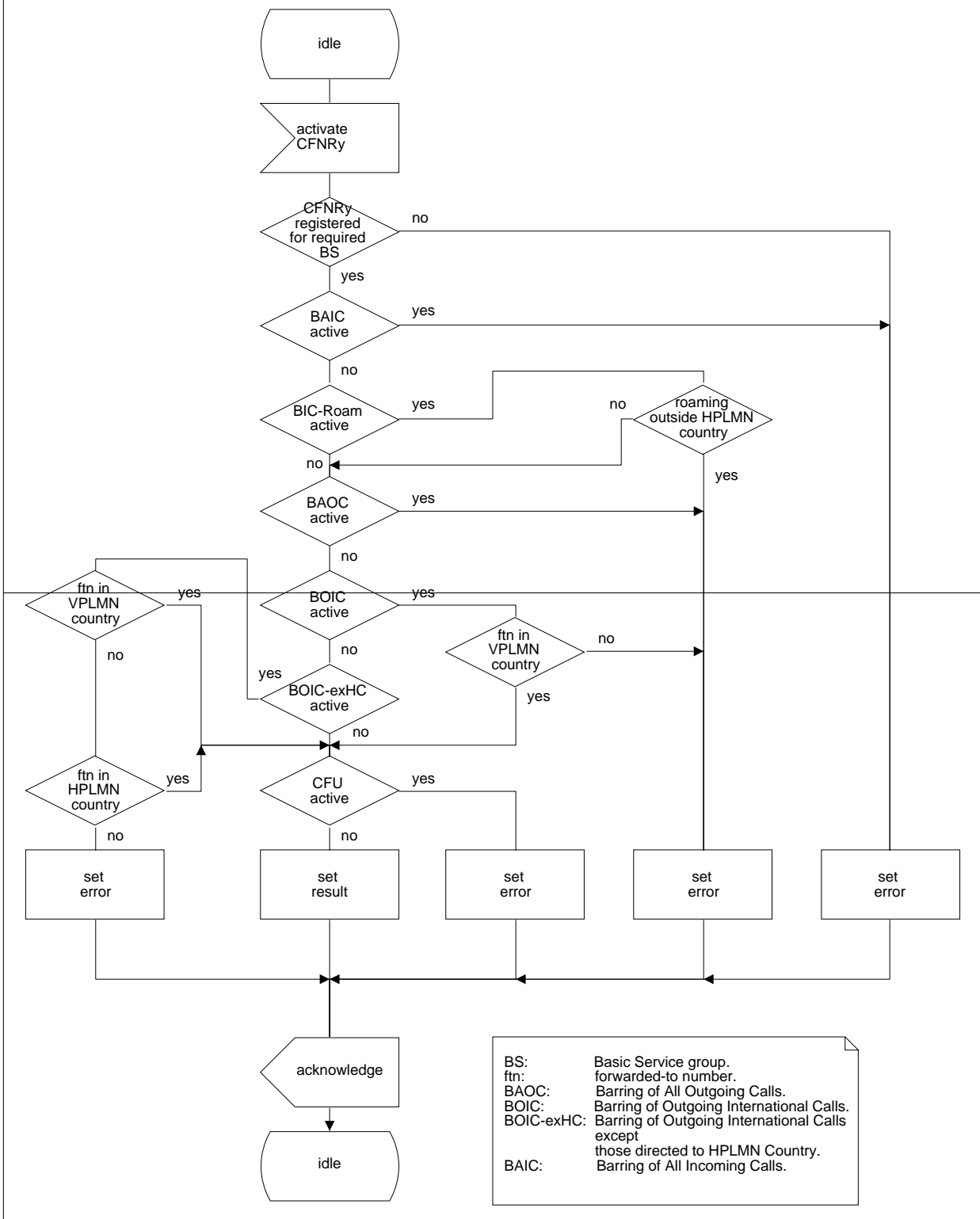

Figure 3.5: Activation of call forwarding on no reply

Process CFNRy3

382_36(1)



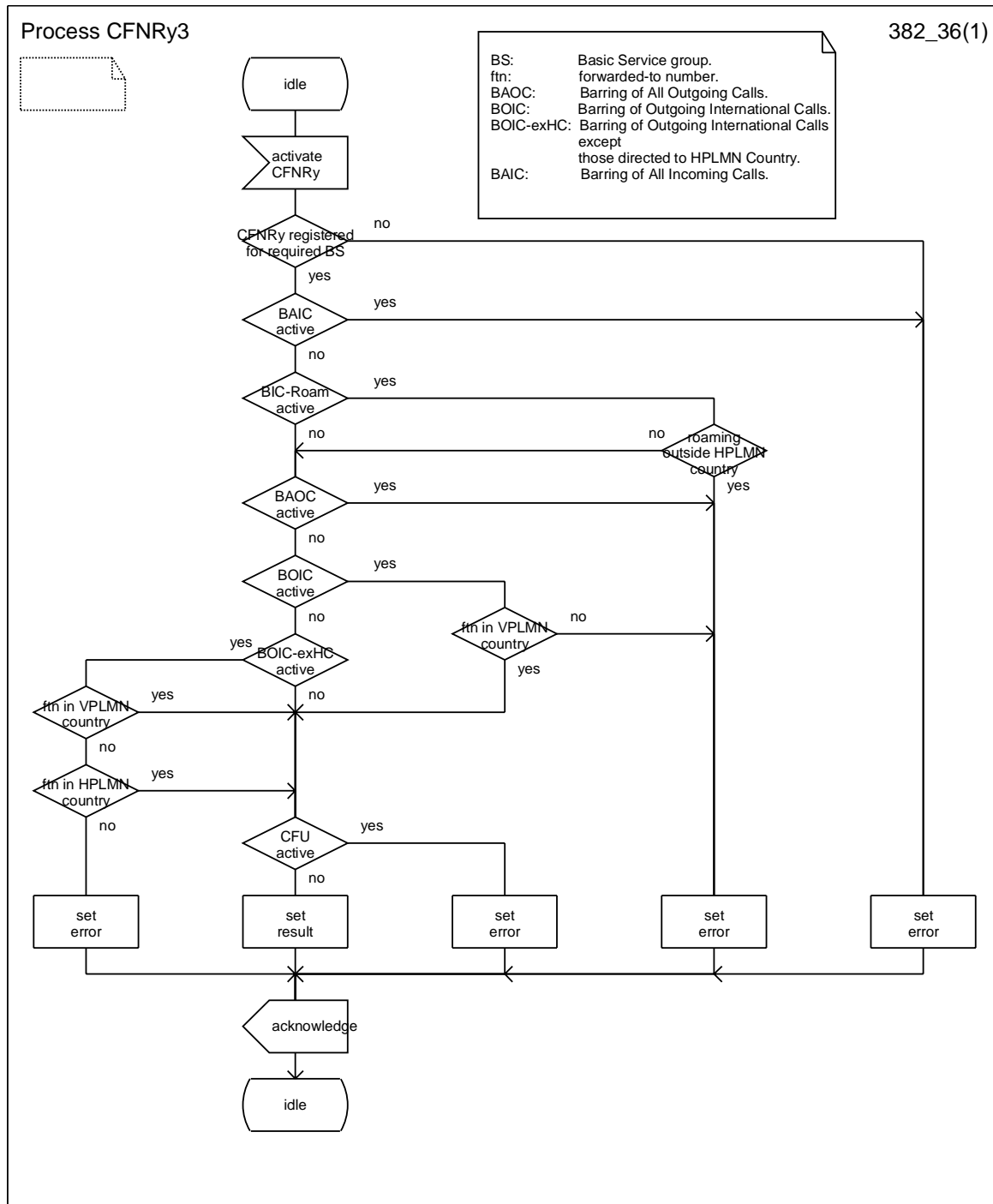

Figure 3.6: CFNRy3 Call forwarding on no reply activation process

3.1.4 Deactivation

The same rules apply for the deactivation of CFNRy as were described for CFU in subclause 1.1.4 above, see figure 3.7 and 3.8.

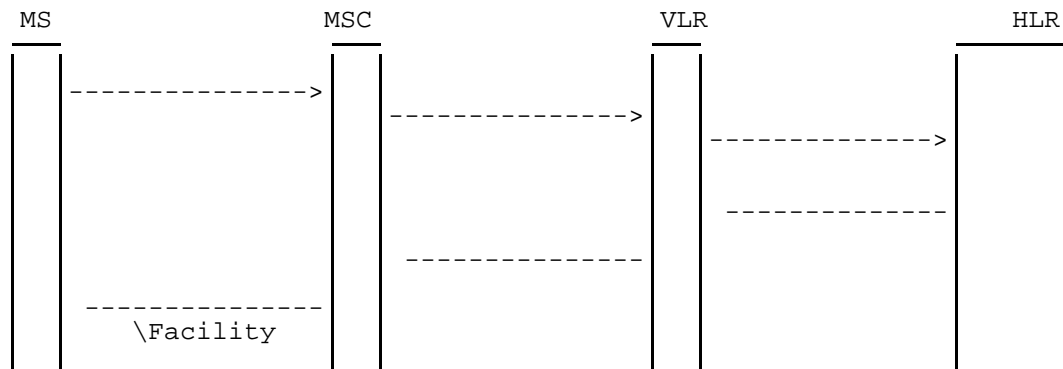
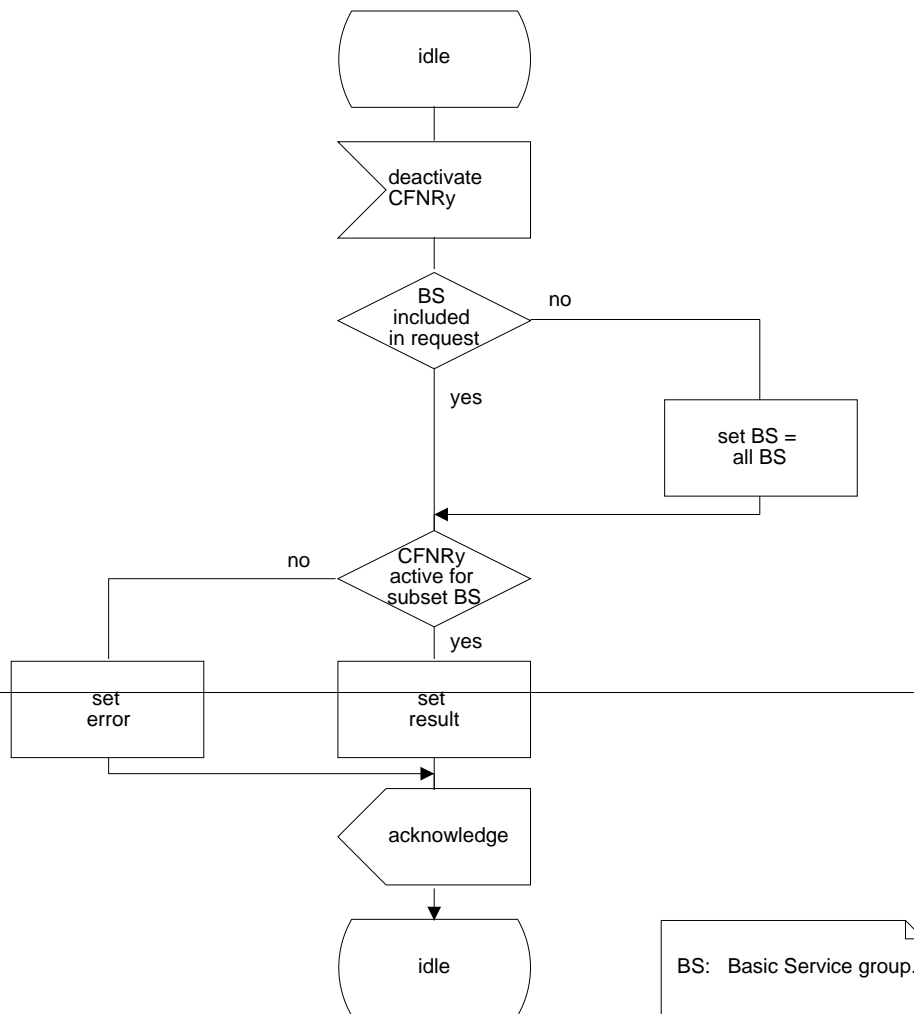

Figure 3.7: Deactivation of call forwarding on no reply

Process CFNRy4

382_38(1)



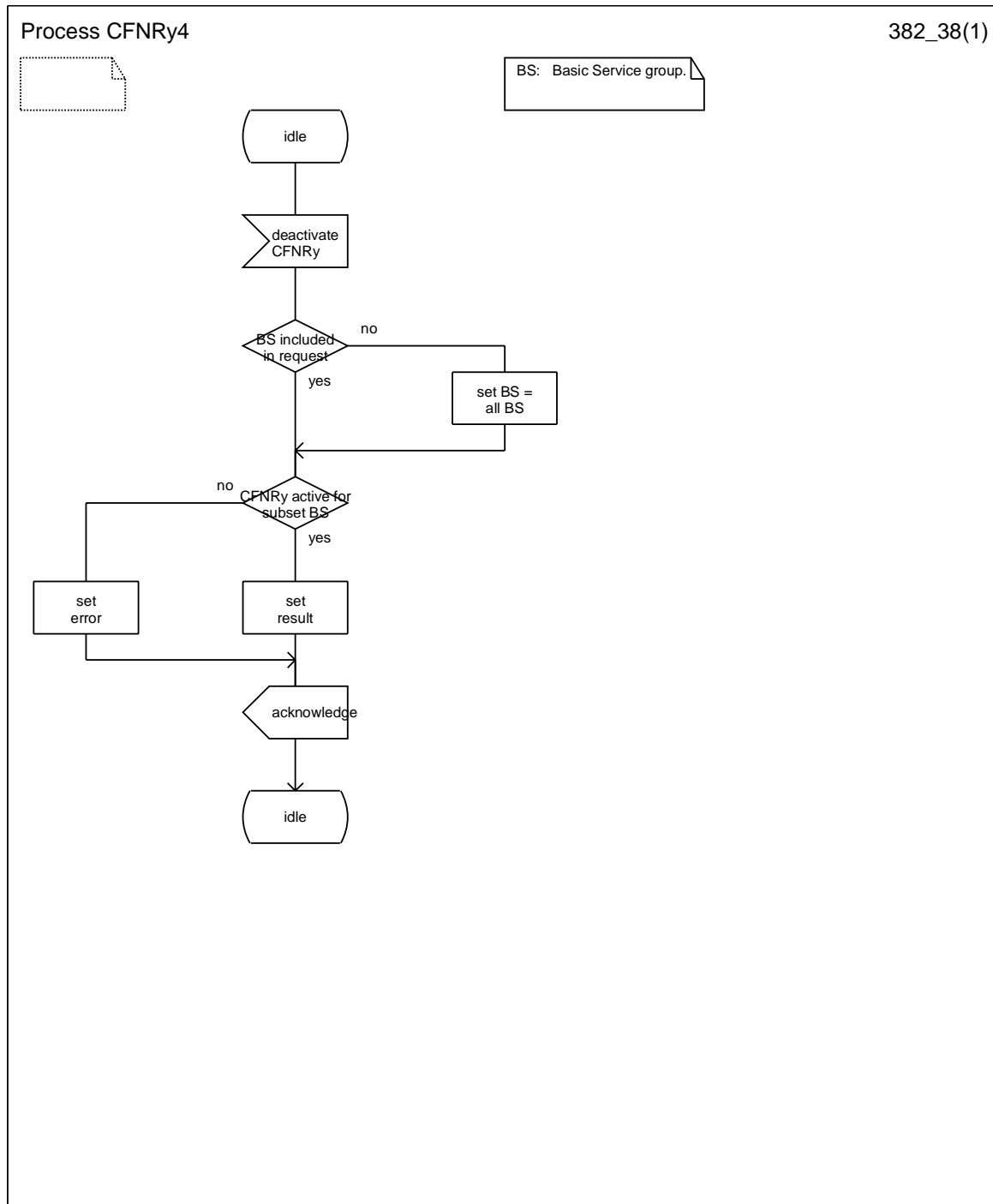

Figure 3.8: CFNRy4 Call forwarding on no reply deactivation process

3.1.5 Interrogation

Data request

The data request procedure enables the mobile subscriber to obtain information about the data stored in the PLMN. Interrogation of CFNRy is handled by the VLR which returns the required information or error to the MS, see figure 3.9.

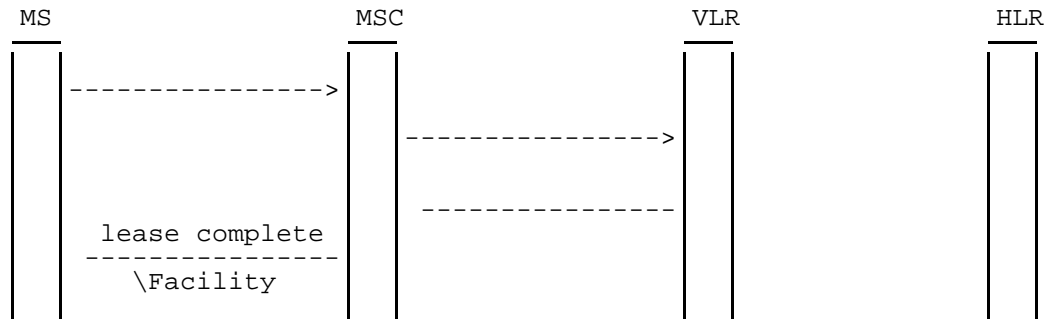

Figure 3.9: Interrogation of call forwarding on no reply

3.2 Functions and information flows

The following Mobile Additional Function has been identified for the PLMN:

MAF009

Call forwarding on no reply authorizations examination

The ability of a PLMN component to determine the authorizations relating to call forwarding on no reply. See figure 3.10.

Location: VLR.

The information flows for forwarding to fixed terminal and to mobile station are shown in figures 3.11 and 3.12 respectively.

Process MAF009

382_3A(1)

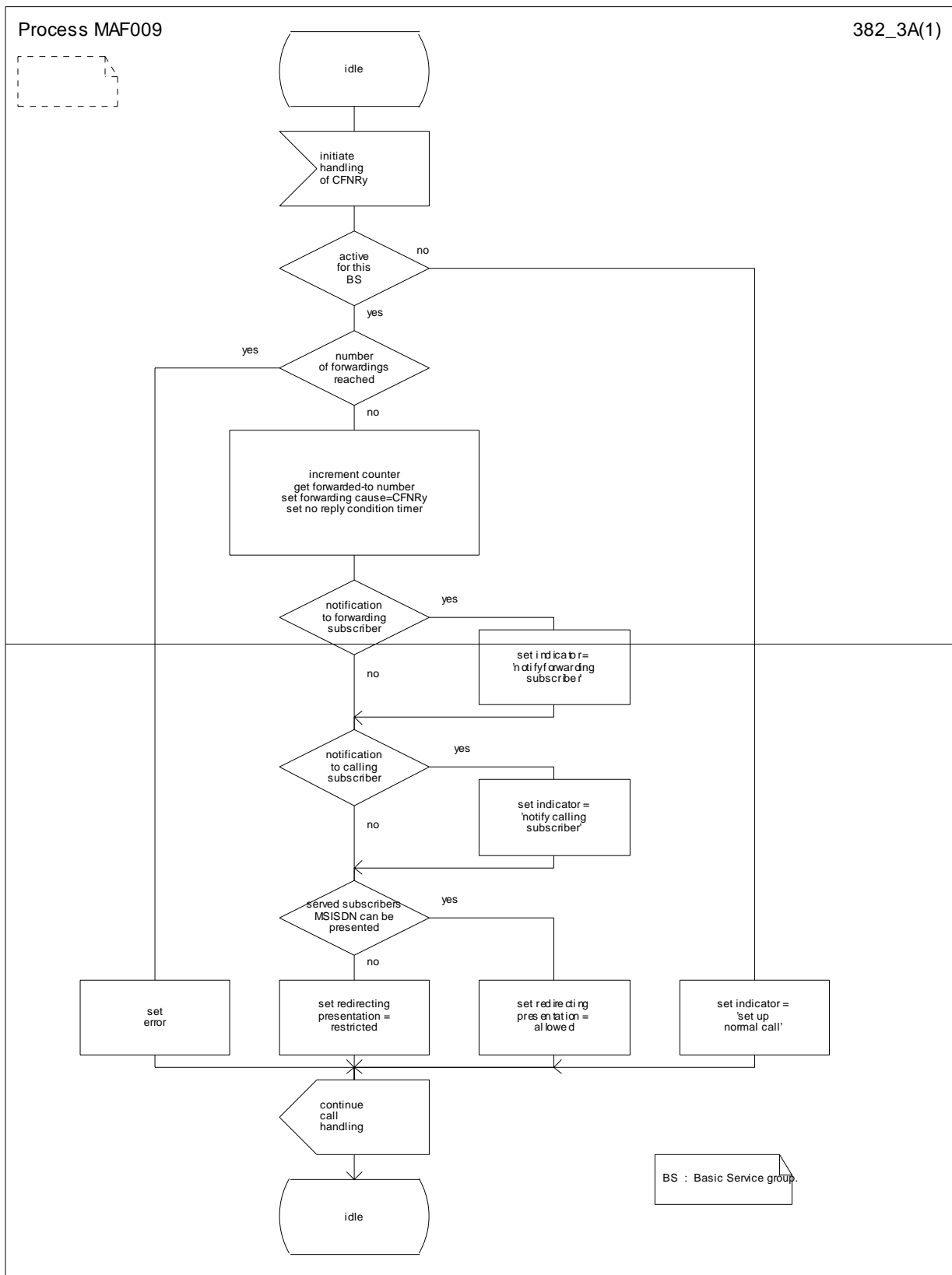

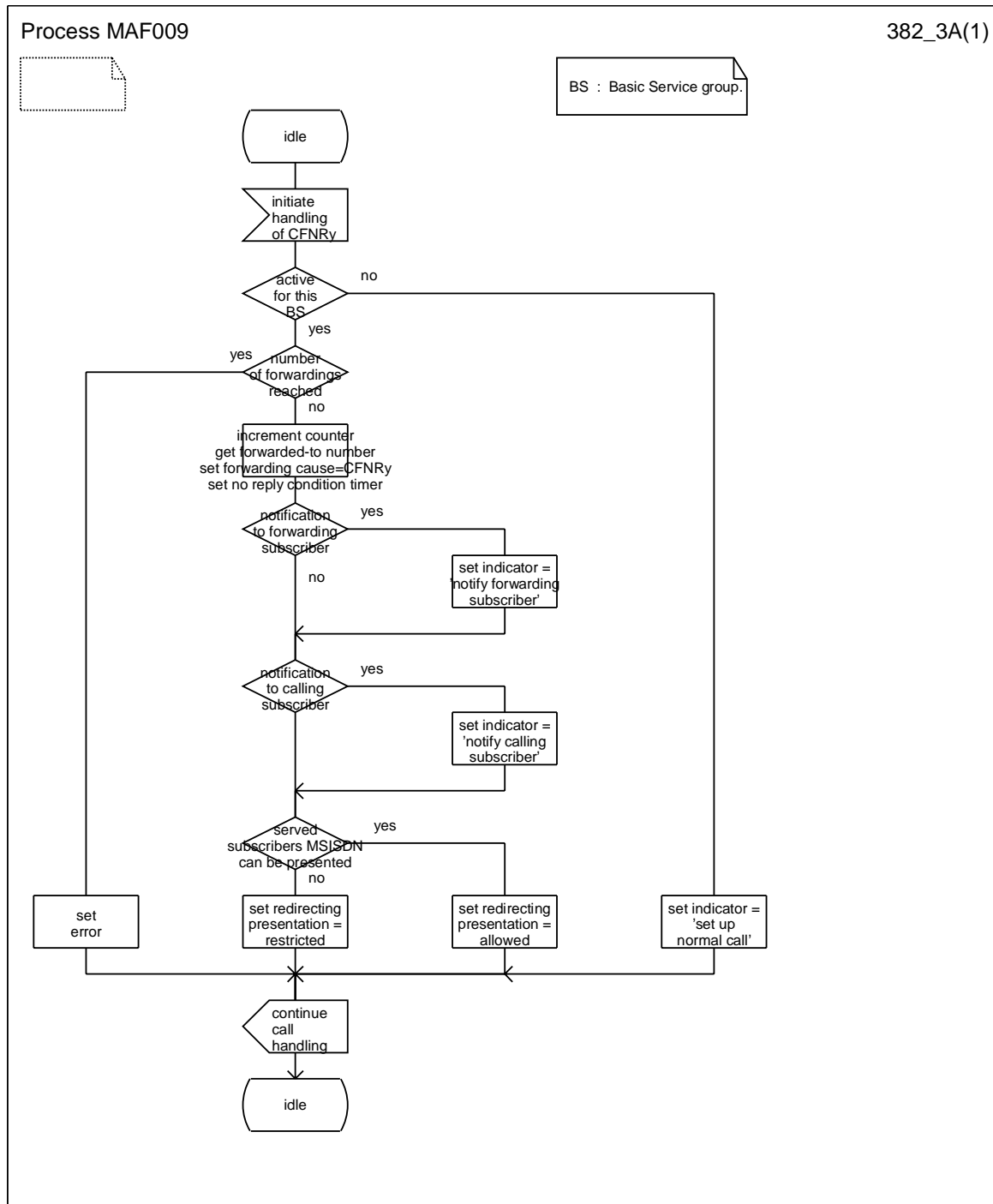
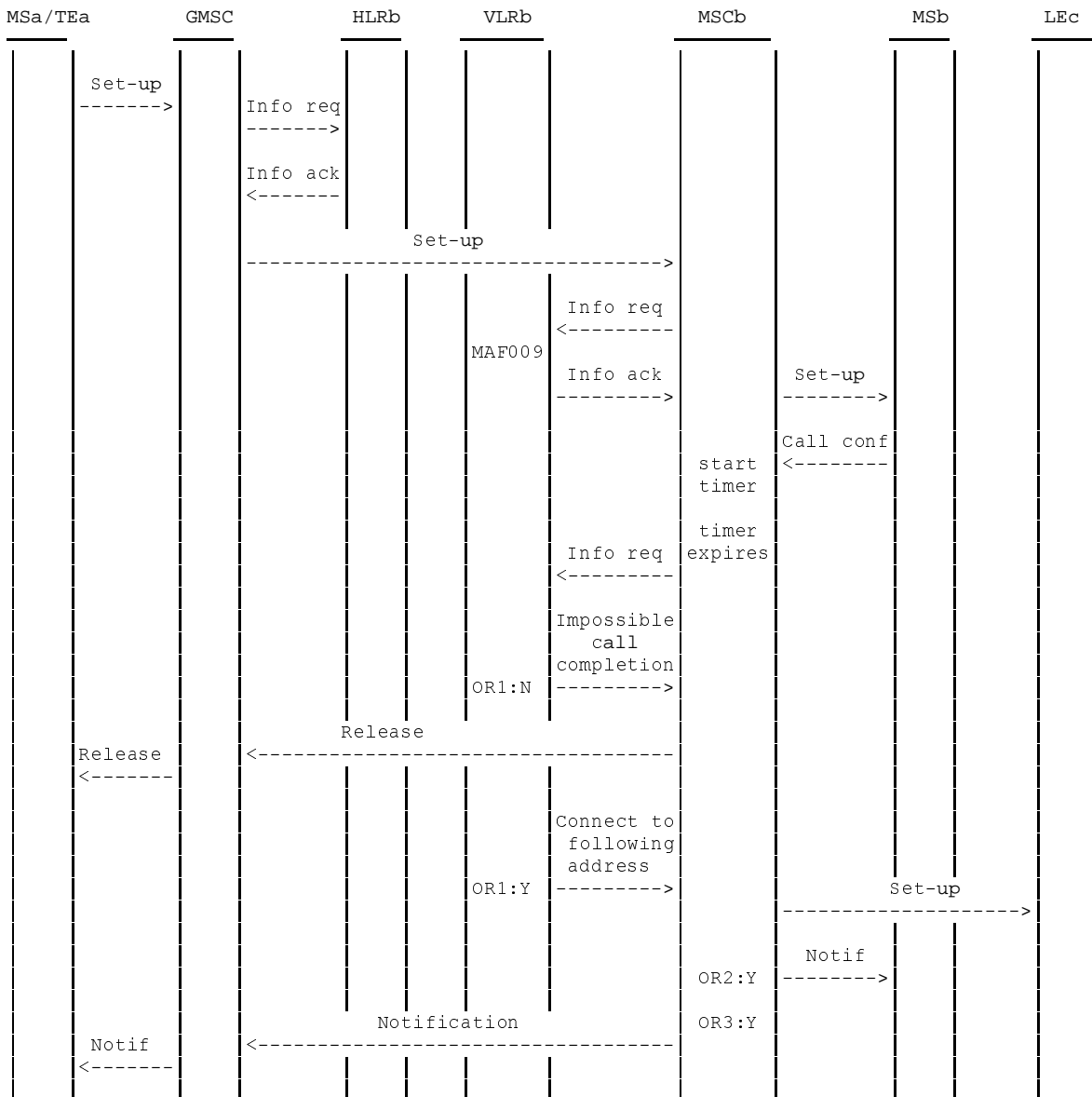
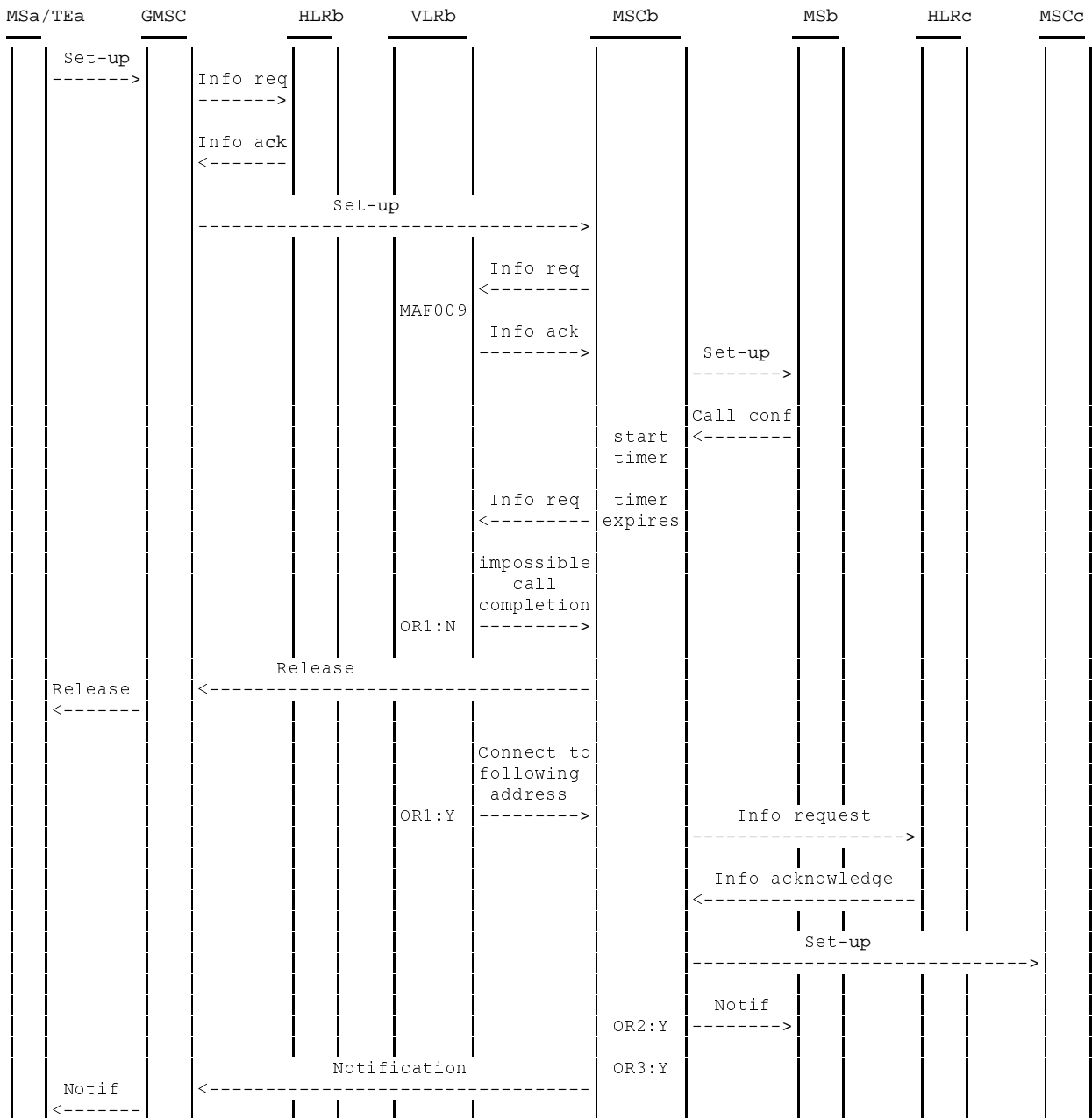

Figure 3.10: MAF009 Call forwarding on no reply authorisations examination (VLR)



NOTE: info: information
 req: request
 ack: acknowledge
 notif: notification
 conf: confirmation
 OR1: Call to be forwarded
 OR2: Notification to forwarding subscriber required
 OR3: Notification to calling subscriber required
 Y: Yes
 N: No

Figure 3.11: Information flow for call forwarding on no reply (to fixed terminal)



NOTE: info: information
 req: request
 ack: acknowledge
 notif: notification
 conf: confirmation
 OR1: Call to be forwarded
 OR2: Notification to forwarding subscriber required
 OR3: Notification to calling subscriber required
 Y: Yes
 N: no

Figure 3.12: Information flow for call forwarding on no reply (to mobile station)

3.3 Information stored in the HLR

The following logical states are applicable for CFNRy (refer to 3G TS 23.011 for an explanation of the notation):

Provisioning State	Registration State	Activation State	HLR Induction State
(Not Provisioned,	Not Registered,	Not Active,	Not Induced)
(Provisioned,	Not Registered,	Not Active,	Not Induced)
(Provisioned,	Registered,	Not Active,	Not Induced)
(Provisioned,	Registered,	Active and Quiescent,	Not Induced)
(Provisioned,	Registered,	Active and Operative,	Not Induced)

The registration and activation state may be different for each applicable elementary basic service group.

The provisioning state shall be on a per subscriber basis, and hence the same for all basic service groups.

The HLR shall store:

- the state of CFNRy (which shall be one of the valid states listed above) for each applicable elementary basic service group;
- the subscription option "notification to the calling party" on a per subscriber basis;

This subscription option takes one of the following values:

- no notification;
- notification.
- the subscription option "notification to the forwarding party" on a per subscriber basis;

This subscription option takes one of the following values:

- no notification;
- notification.
- the subscription option "MSISDN of the served subscriber can be presented to the forwarded-to subscriber" on a per subscriber basis;

This subscription option takes one of the following values:

- presentation restricted;
- presentation allowed.
- the registration parameter "forwarded-to number" (possibly including a forwarded-to sub-address) for each applicable elementary basic service group;
- the registration parameter "no reply condition timer" for each applicable elementary basic service group.

This parameter may take values in the range 5 - 30 seconds in steps of 5 seconds.

3.4 State transition model

The following figure shows the successful cases of transition between the applicable logical states of CFNRy. The state changes are either caused by actions of the service provider, the mobile user or the network.

Note that error cases are not shown in the diagram as they normally do not cause a state change. Additionally, some successful requests may not cause a state change. Hence, they are not shown in the diagram. The diagram only shows operations on an elementary basic service group.

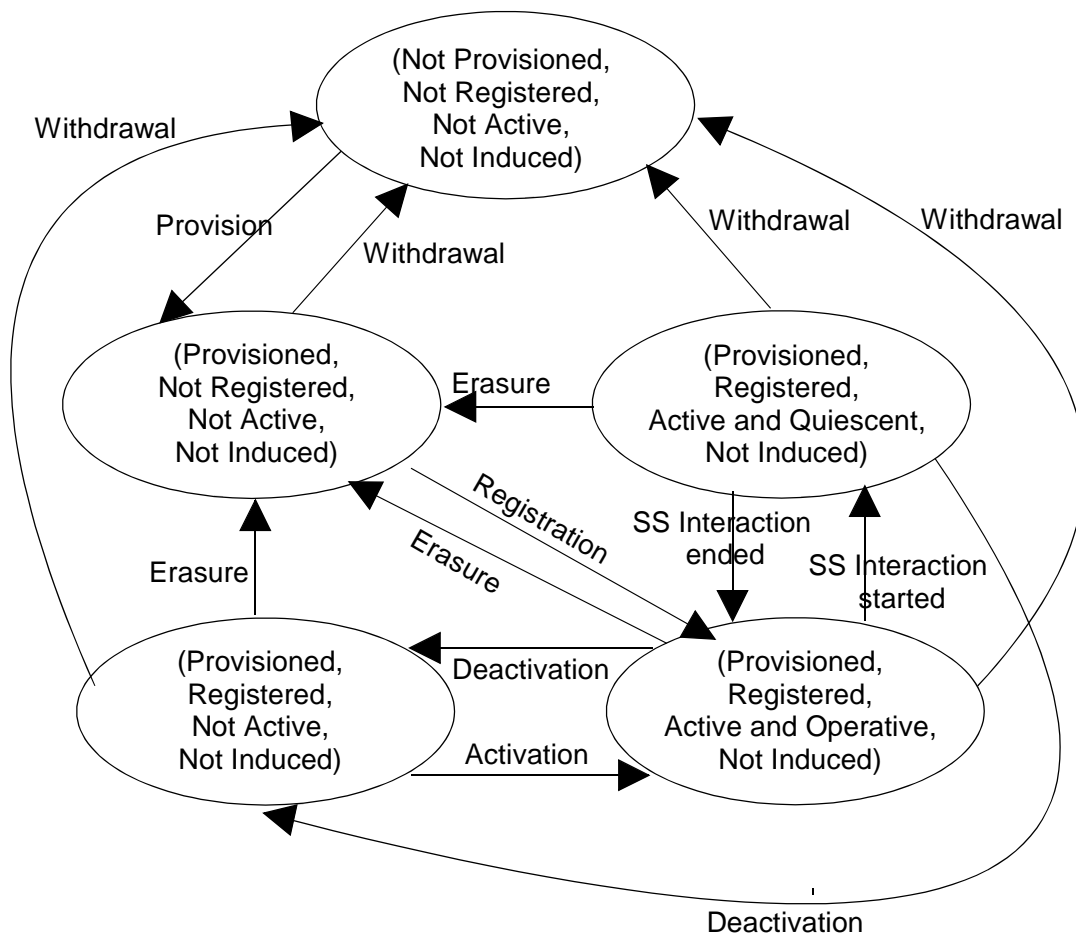

Figure 3.13: State transition model for CFNRy

3.5 Transfer of information from HLR to VLR

If the provisioning state for CFNRy is "Provisioned" then, when the subscriber registers on a VLR, the HLR shall send that VLR information about the logical state of CFNRy for all relevant elementary basic service groups.

If the registration state for CFNRy is "Registered" then, when the subscriber registers on a VLR, the HLR shall send that VLR the registration parameter "forwarded-to number" and "no reply condition timer" for all relevant elementary basic service groups and information about the subscription options "notification to the calling party", "notification to the forwarding party" and "MSISDN of the served subscriber can be presented to the forwarded-to subscriber".

If the logical state, the registration parameter "forwarded-to number" or the registration parameter "no reply condition timer" of CFNRy is changed while a subscriber is registered on a VLR then for the affected basic service groups, the HLR shall inform the VLR respectively of the new logical state or the new registration parameter of CFNRy.

If information about the subscription options "notification to the calling party" and "notification to the forwarding party" of CFNRy is changed while a subscriber is registered on a VLR and the registration state of CFNRy is "Registered" then the HLR shall inform the VLR of the new information about the subscription options of CFNRy.

3.6 Information stored in the VLR

For CFNRy the VLR shall store the service state information, the registration parameter "forward-to number", the registration parameter "no reply condition timer" and the subscription options received from the HLR.

3.7 Handover

Handover will have no impact on the control procedure and the operation of the service.

3.8 Cross phase compatibility

3.8.1 MS, MSC, VLR or HLR only support Phase 1 control of SS by the subscriber

In response to a CFNRy interrogation request, if the MS or any network element involved is of Phase 1, only information concerning basic service groups for which the activation state has the value "Active and Operative" will be returned. This means that the subscriber will not be aware that the forwarded to number is registered if CFNRy is deactivated or active (quiescent). A subaddress (if registered) will not be included.

Note that if any network element involved is of Phase 1, CFNRy Registration requests which use a subaddress and all CFNRy Activation and Deactivation requests will be rejected, as these are not specified in Phase 1.

3.8.2 HLR only supports Phase 1 updating of subscriber information

If the VLR receives the SS-Status parameter from a Phase 1 HLR it shall act if it has received the SS-Status parameter with the values shown in the following:

- 1) Registered, Activated => P bit =1, R bit = 1, A bit = 1, Q bit = 0;
- 2) Registered, Deactivated => P bit =1, R bit = 1, A bit = 0, Q bit = 0 or 1;
- 3) Erased => P bit =1, R bit = 0, A bit = 0, Q bit = 0 or 1.

3.8.3 VLR only supports Phase 1 updating of subscriber information

When passing CFNRy information to a Phase 1 VLR, the HLR shall send the service state information in a form which the VLR can accept, based on the logical state held in the HLR, as follows:

- 1) (Provisioned, Not Registered, Not Active, Not Induced)
=> Erased, Deactivated;
- 2) (Provisioned, Registered, Not Active, Not Induced)
=> Registered, Deactivated;
- 3) (Provisioned, Registered, Active and Operative, Not Induced)
=> Registered, Activated;
- 4) (Provisioned, Registered, Active and Quiescent, Not Induced)
=> Registered, Deactivated.

The HLR shall not pass a subaddress to a Phase 1 VLR.

3.8.4 VLR only supports Phase 1 call handling

When a call is forwarded on no reply, as the HLR does not pass the subaddress to the VLR, calls shall be forwarded without the subaddress.

3.8.5 VLR does not support CAMEL or supports CAMEL Phase 1 only

When passing CFNRy information to a VLR not supporting CAMEL or supporting CAMEL Phase 1 only, the HLR shall send the registration parameter "forwarded-to number" only if it is registered in a format which the VLR can accept, i.e. international format.

If the registration state for CFNRy is "Registered" and the forwarded-to number is registered in a format other than international, then when updating a VLR not supporting CAMEL or supporting CAMEL Phase 1 only the HLR shall modify the service state information of CFNRy as follows.

- 1) (Provisioned, Registered, Not Active, Not Induced)
=> (Provisioned, Not Registered, Not Active, Not Induced)
- 2) (Provisioned, Registered, Active and Operative, Not Induced)
=> (Provisioned, Not Registered, Not Active, Not Induced)
- 3) (Provisioned, Registered, Active and Quiescent, Not Induced)
=> (Provisioned, Not Registered, Not Active, Not Induced)

According to the definitions in subclause 3.5 no forwarded-to number will be passed to the VLR in these cases. The modification of the service state information sent to the VLR shall have no impact on the service state information stored in the HLR.

If the VLR supports Phase 1 updating of subscriber information only, a further translation of the service state information as defined in subclause 3.8.3 shall be performed by the HLR.

3.9 Contents of messages

The same additions apply for CFNRy as for CFB, see subclause 2.9.

3.10 Support of Long Forwarded-to Numbers

The handling for CFNRy is the same as that for CFB, see subclause 2.10.

4 Call forwarding on mobile subscriber not reachable

4.1 Handling of call forwarding on mobile subscriber not reachable

4.1.1 Registration

The same rules apply for the registration of Call Forwarding on Mobile Subscriber Not Reachable as were described for Call Forwarding Unconditional in subclause 1.1.1 above, with the exception of the checking of interaction with other supplementary services. Basic registration of information is illustrated in figure 4.2.

Supplementary Service Interaction

Possible interaction situations between CFNRc and other supplementary services must then be checked. This is described in figure 4.2. Also see 3G TS 22.004 and 3G TS 22.082. For interaction between CFNRc and other supplementary services (ie not call barring or call forwarding services), the reader is referred to the respective technical specification for those supplementary services.

Interaction with CAMEL Phase 2 or higher

Possible interaction between CFNRc and CAMEL Phase 2 or higher is described in figure 4.2. If CAMEL Phase 2 or higher is not supported in the HLR, processing continues from the "No" exit of the test "Result=Pass".

The information flow for registration of call forwarding on mobile subscriber not reachable is shown in figure 4.1.

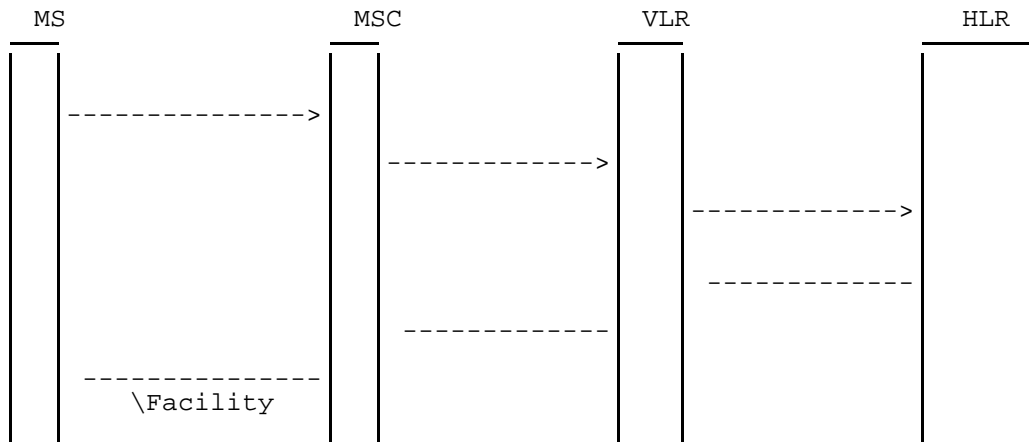
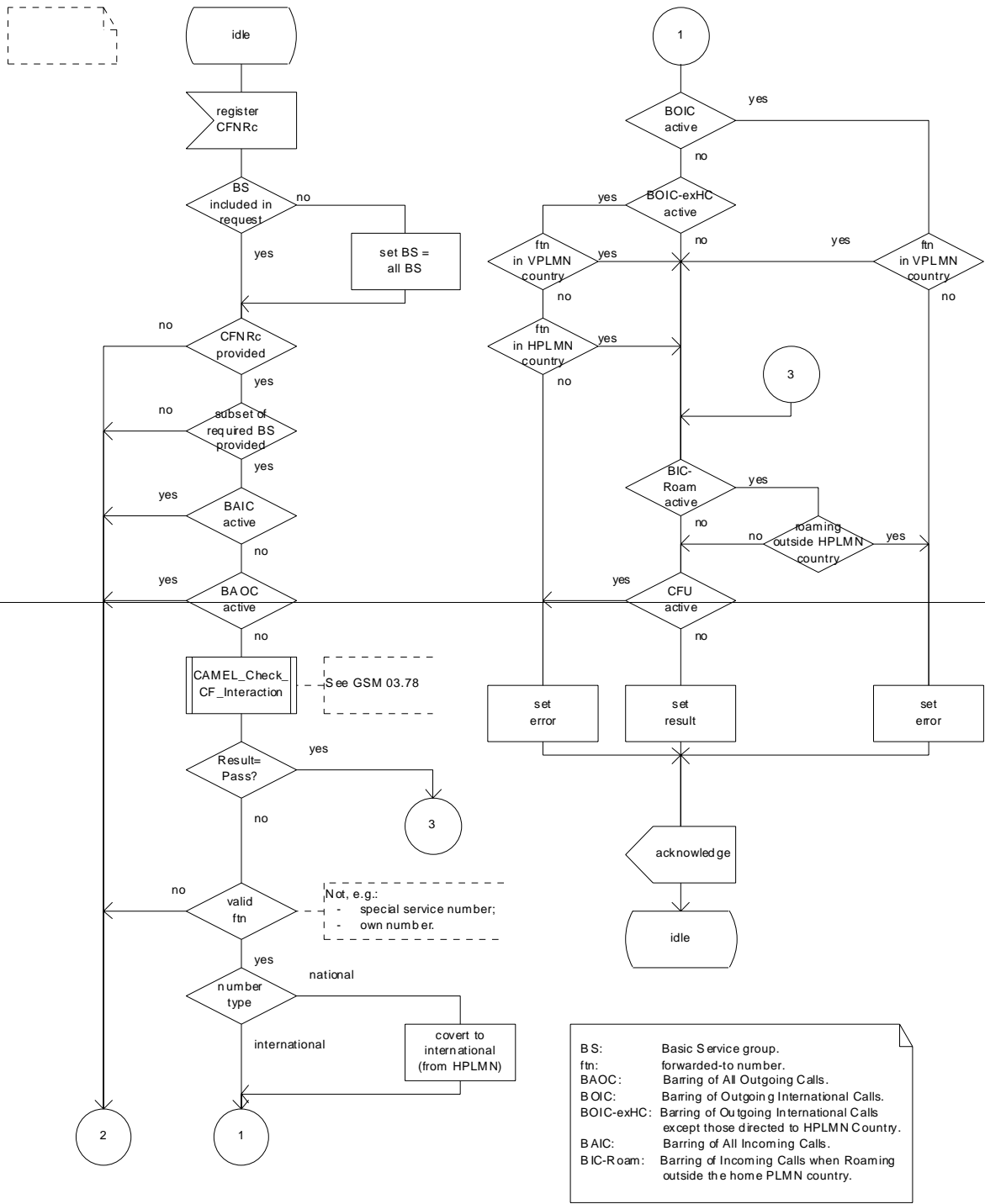

Figure 4.1: Registration of call forwarding on mobile subscriber not reachable

Process CFNRc1

382_42(1)



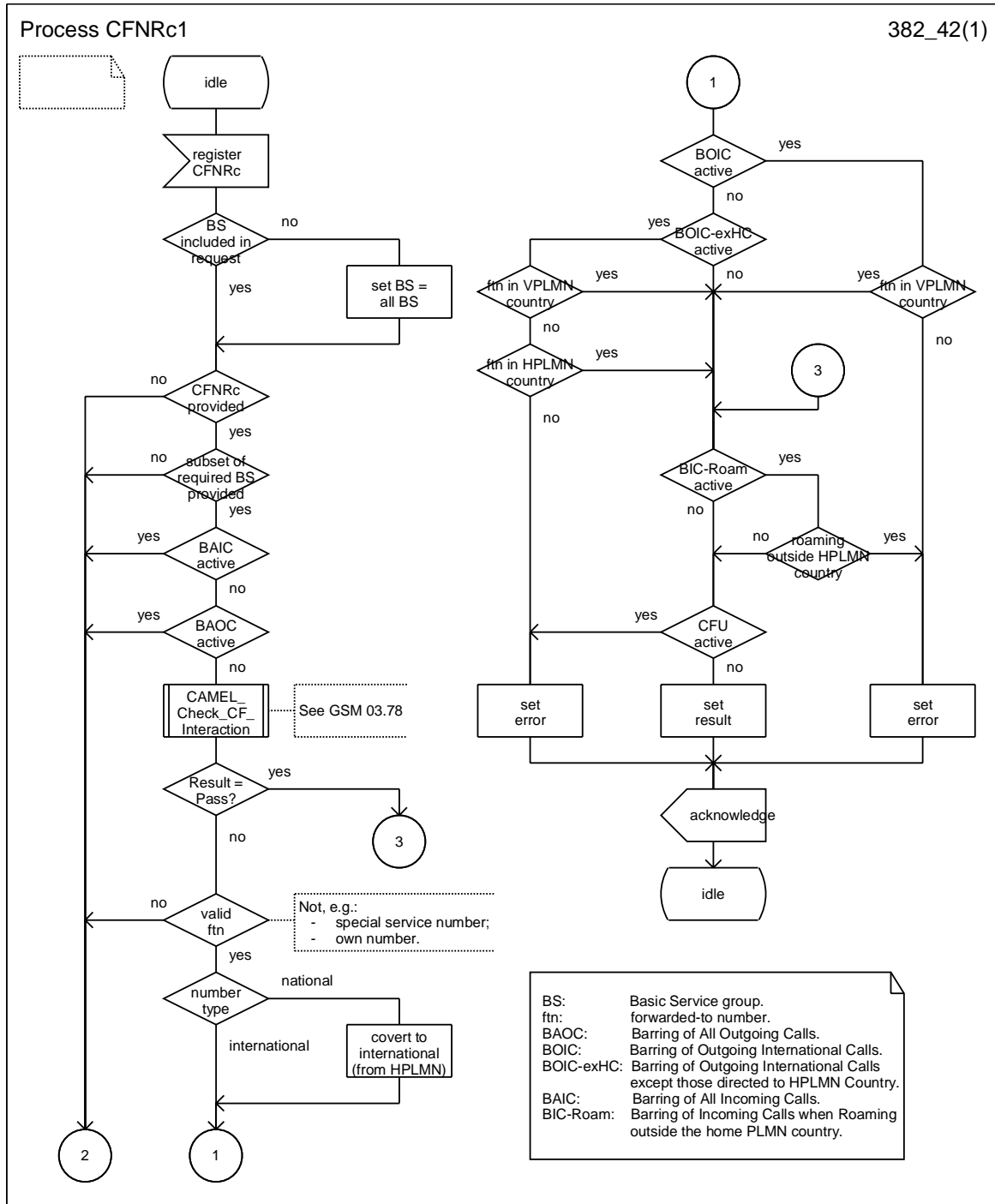

Figure 4.2: CFNRc1 Call forwarding on mobile subscriber not reachable registration process

4.1.2 Erasure

The same rules apply for the erasure of CFNRc as were described for CFU in subclause 1.1.2 above. However, no checks for interaction with other supplementary services are required for erasure of CFNRc, see figure 4.4.

The information flow for registration of CFNRc is shown in figure 4.3.

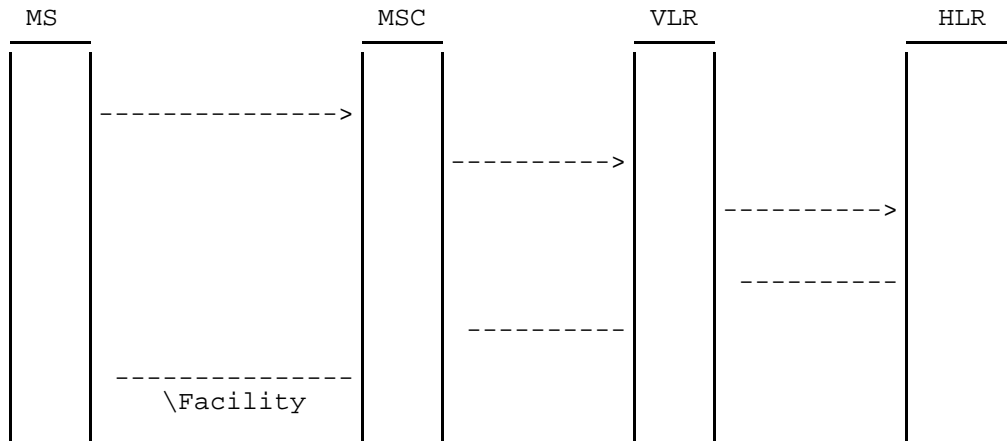
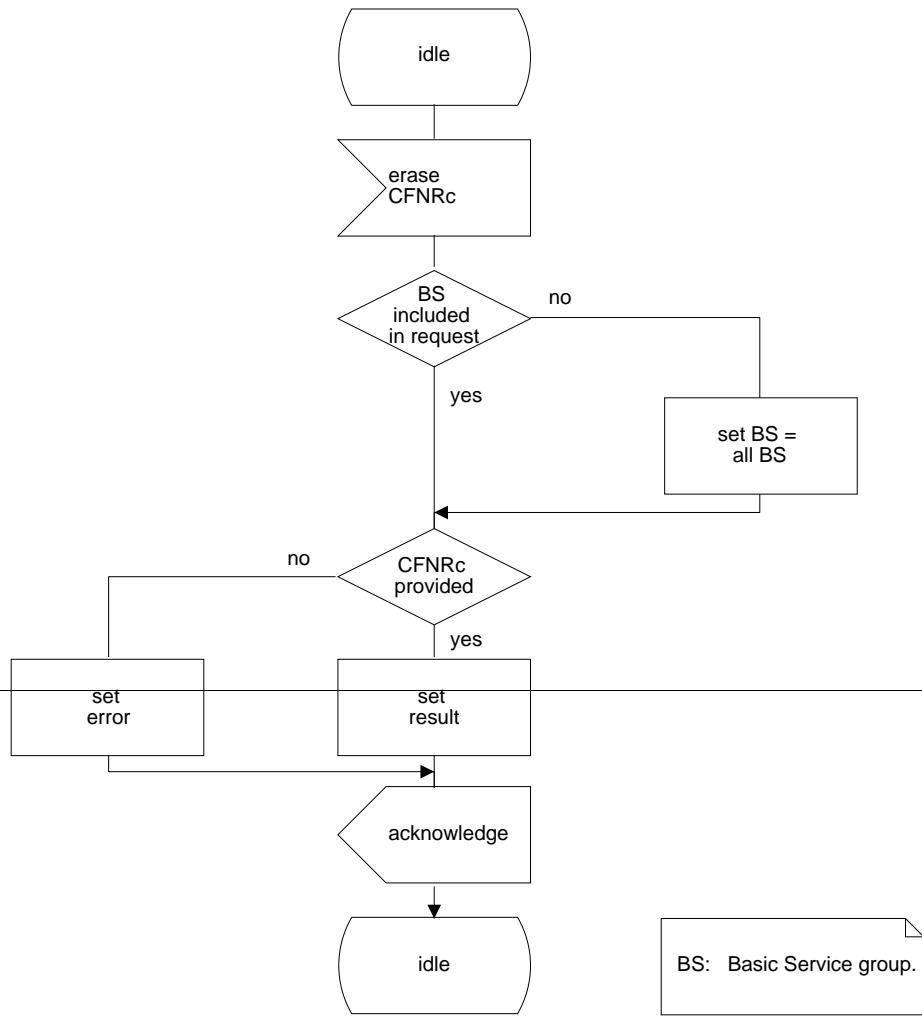

Figure 4.3: Erasure of call forwarding on mobile subscriber not reachable

Process CFNRc2

382_44(1)



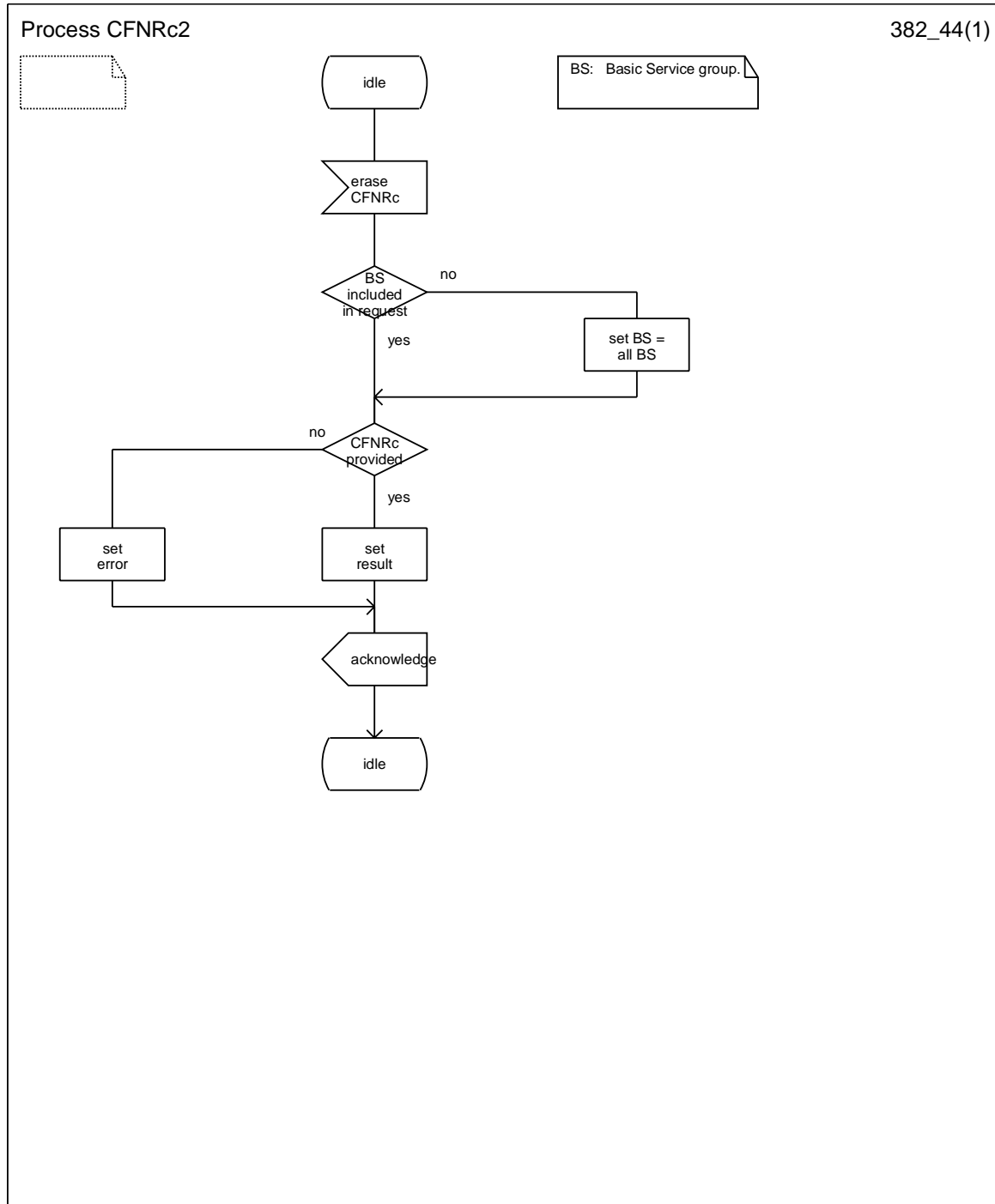

Figure 4.4: CFNRc2 Call forwarding on mobile subscriber not reachable erasure process

4.1.3 Activation

The same rules apply for the activation of CFNRC as were described for CFU in subclause 1.1.3 above, with the exception of the checking of interaction with other supplementary services. Basic activation of CFNRC is illustrated in figure 4.6.

Supplementary Service Interaction

Possible interaction situations between CFNRC and other supplementary services must then be checked. This is described in figure 4.6. Also see 3G TS 22.004 and 3G TS 22.082. For interaction between CFNRC and other supplementary services (i.e. not call barring or call forwarding services), the reader is referred to the respective technical specification for those supplementary services.

The information flow for activation of call forwarding on MS not reachable is shown in figure 4.5.

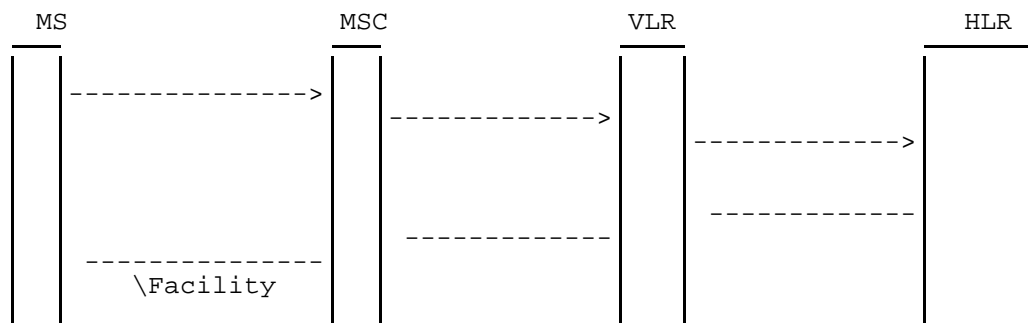
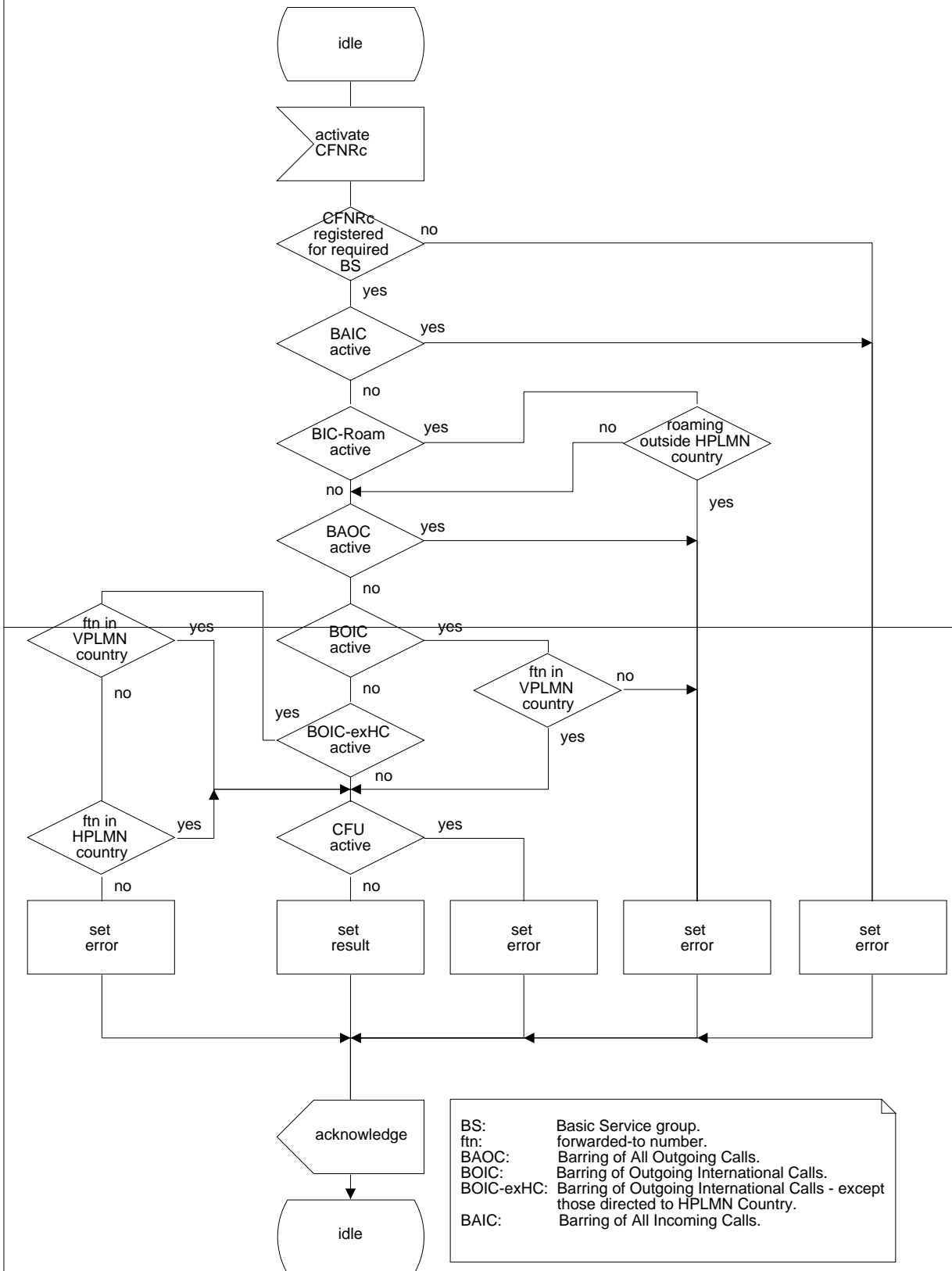

Figure 4.5: Activation of call forwarding on MS not reachable

Process CFNRc3

382_46(1)



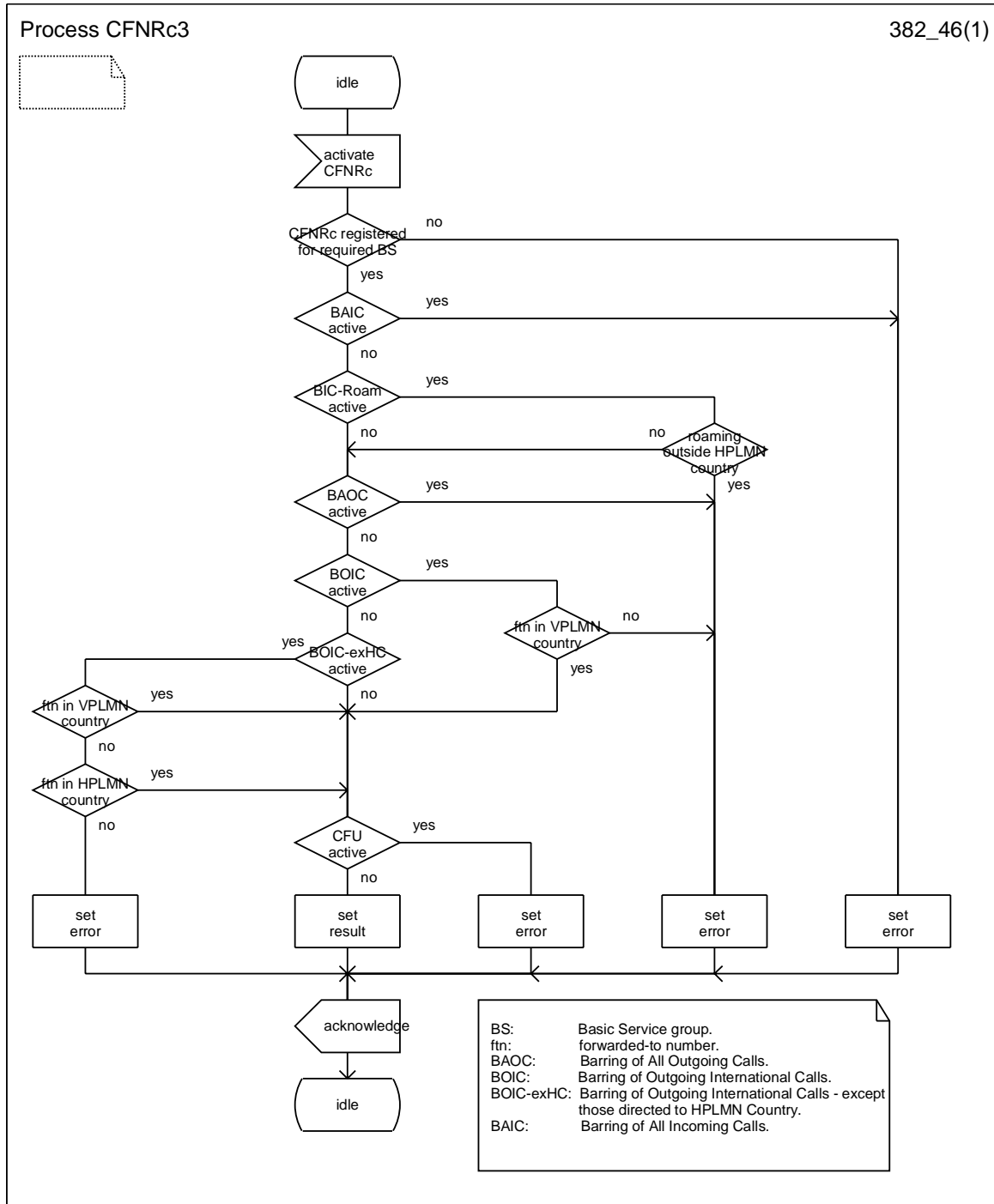
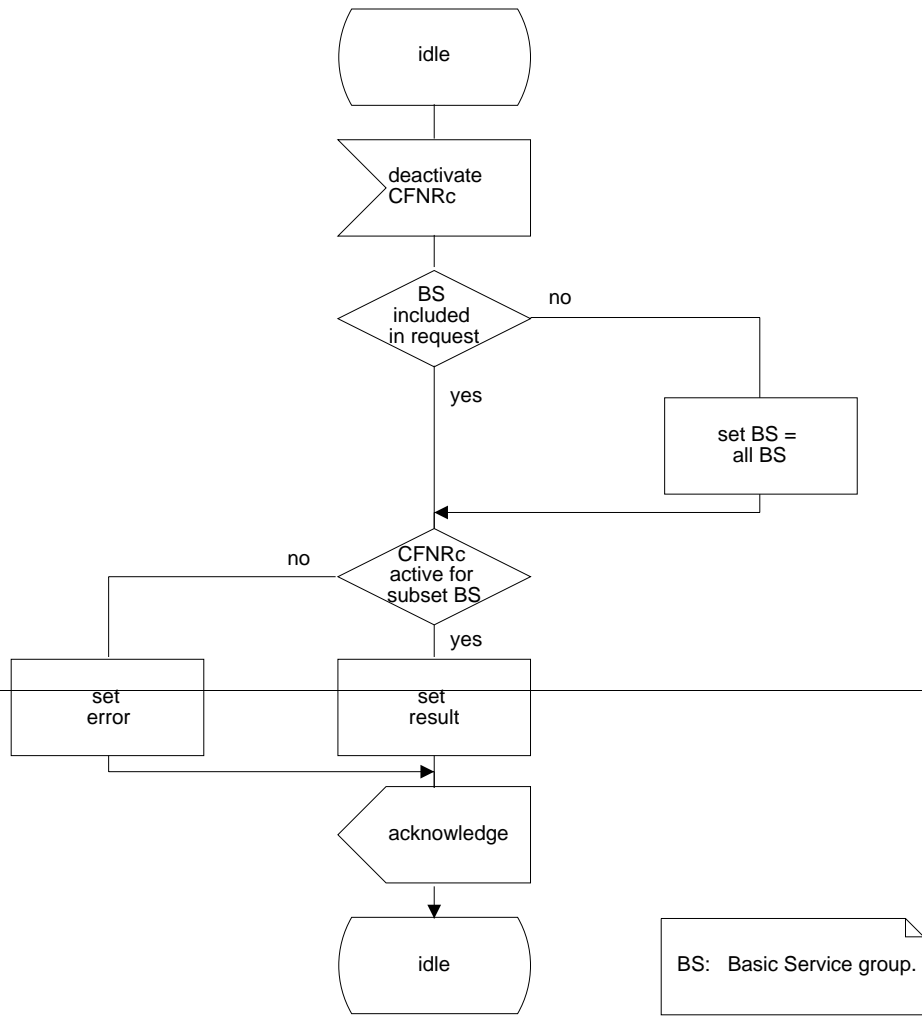

Figure 4.6: CFNRc3 Call forwarding on mobile subscriber not reachable activation process

Process CFNRc4

382_48(1)



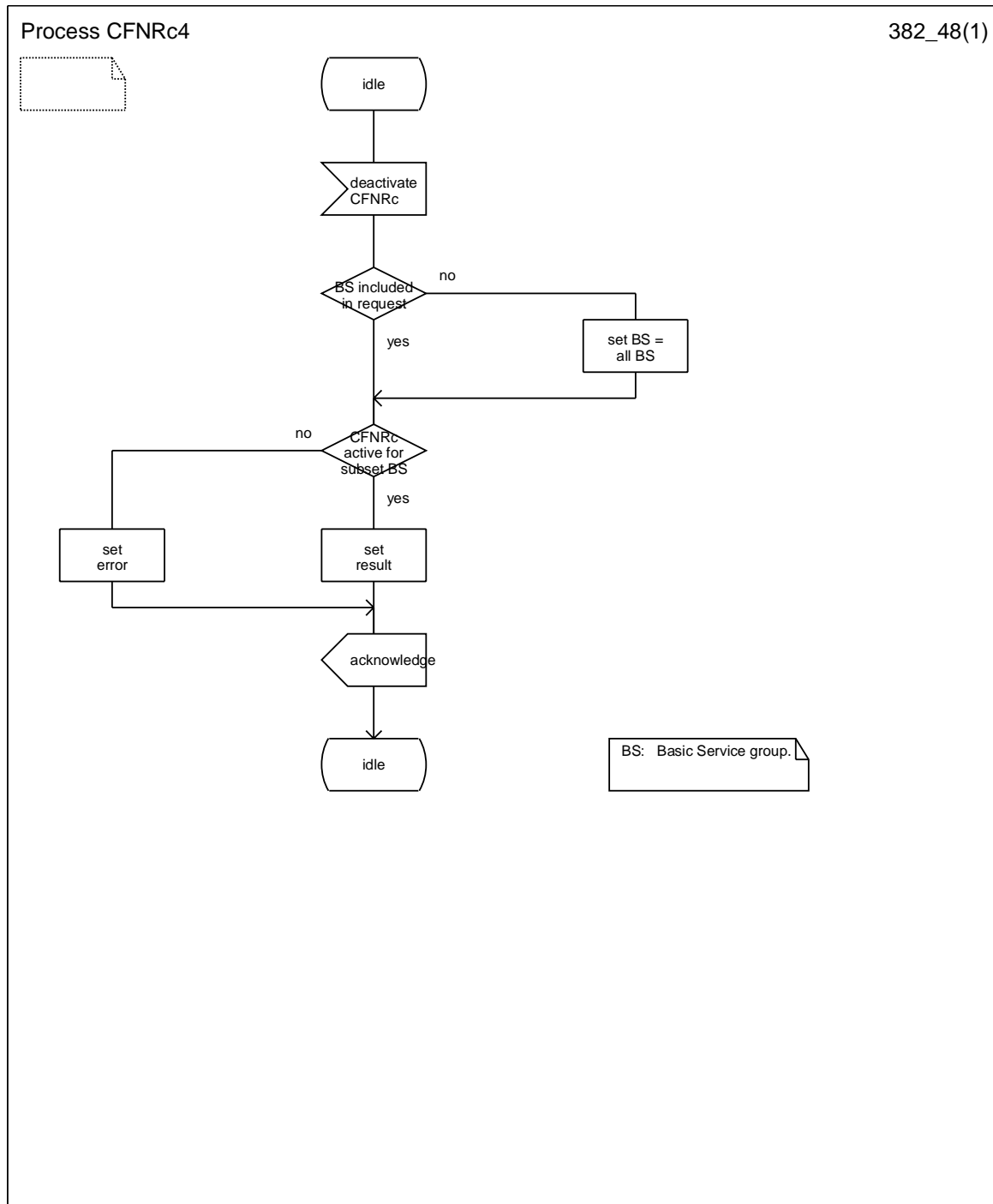

Figure 4.8: CFNRc4 Call forwarding on mobile subscriber not reachable deactivation process

4.1.5 Interrogation

Data request

The data request procedure enables the mobile subscriber to obtain information about the data stored in the PLMN. Interrogation of CFNRc is handled by the VLR which returns the required information or error to the MS, see figure 4.9.

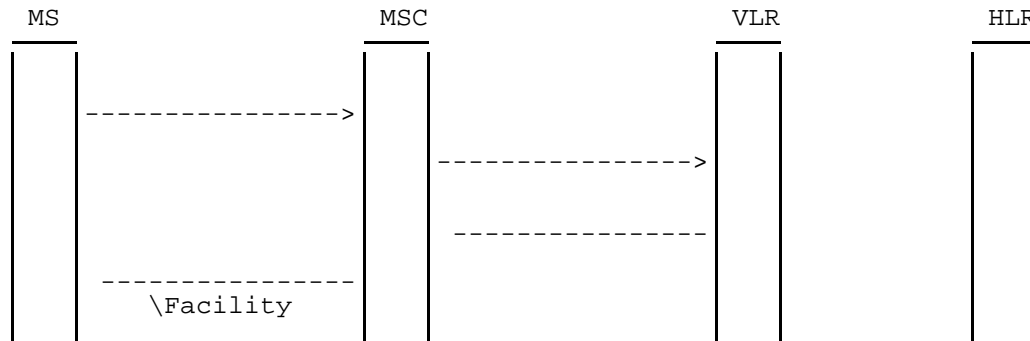

Figure 4.9: Interrogation of call forwarding on mobile subscriber not reachable

4.2 Functions and information flows

4.2.1 Call re-routed from VLR

The following Mobile Additional Function has been identified for the PLMN:

MAF010

Examination of call forwarding on mobile subscriber not reachable authorizations

The ability of a PLMN component to determine the authorizations relating to call forwarding on mobile subscriber not reachable in case the mobile subscriber is not reachable in the VLR, in case of no paging response or radio congestion. See figure 4.10.

Location: VLR.

The information flows for forwarding to fixed terminal and to mobile station are shown in figures 4.11 and 4.12 respectively. These flows represent the case where the mobile subscriber is not reachable in the VLR, and that this fact was not detected at interrogation from the HLR. This situation occurs if the MSC requests the VLR to provide information for a mobile terminating call towards a subscriber who is detached in the VLR.

Figures 4.13 and 4.14 show the information flows in case of no paging response.

Figures 4.15 and 4.16 show the information flows in case of radio congestion.

4.2.2 Call re-routed from HLR

The following Mobile Additional Function has been identified for the PLMN:

MAF010

Examination of call forwarding on mobile subscriber not reachable authorizations

The ability of a PLMN component to determine the authorizations relating to call forwarding on mobile subscriber not reachable in case the mobile subscriber is deregistered or purged in the HLR or not reachable in the VLR. See figure 4.10.

Location: HLR.

The information flows for forwarding to fixed terminal and to mobile station are shown in figures 4.17 and 4.18 respectively. These flows represent the case where the call is re-routed from the HLR because information from the VLR indicates that the subscriber cannot be reached in the VLR. This situation occurs if the VLR detects at roaming number request time that the subscriber concerned is detached or that there is no roaming number available.

Figures 4.19 and 4.20 show the information flows for forwarding to fixed terminal and to mobile station respectively in case where the call is re-routed by the HLR because the subscriber is deregistered or purged in the HLR.

Process MAF010

382_4A(1)

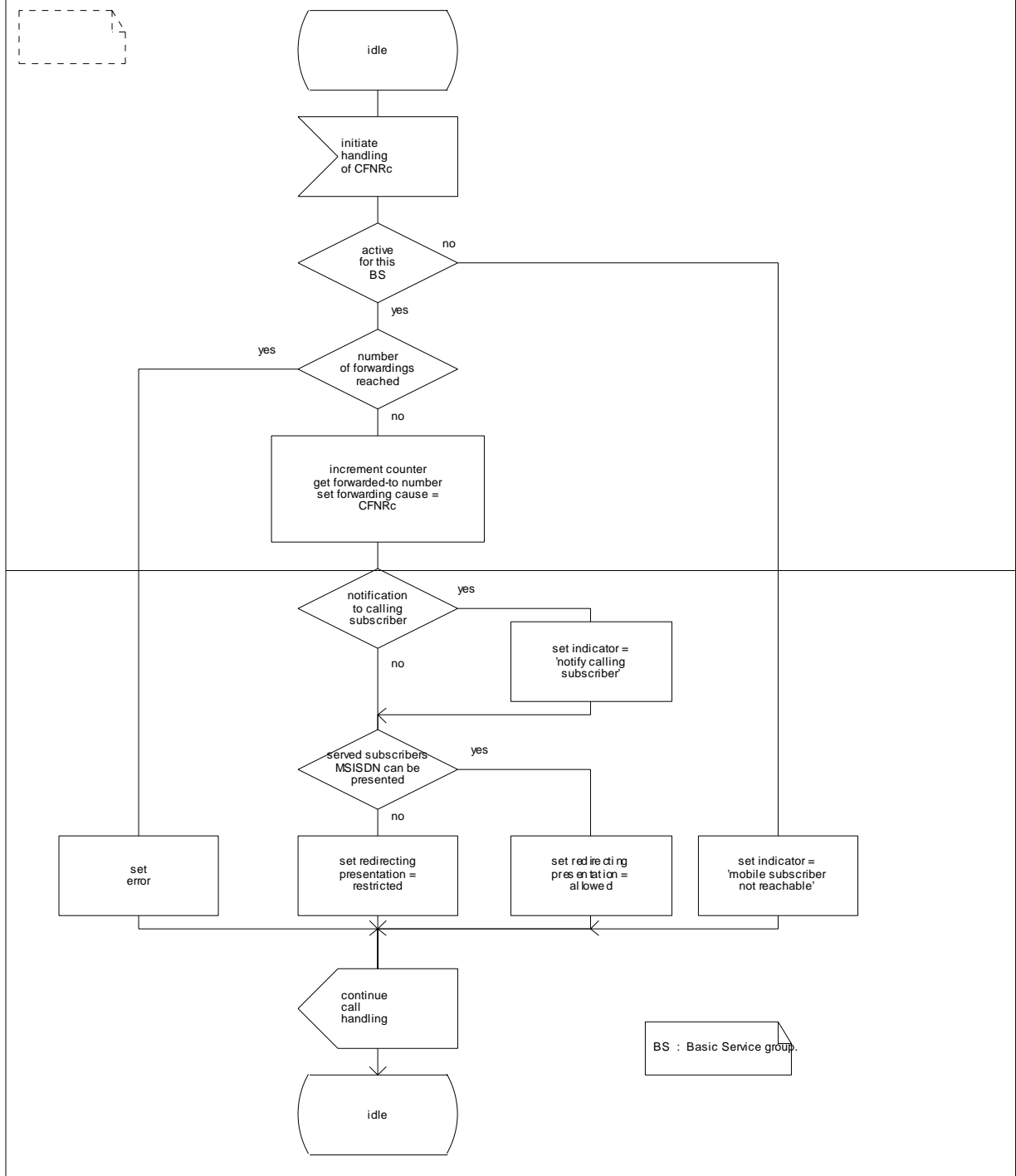

Process MAF010

382_4A(1)

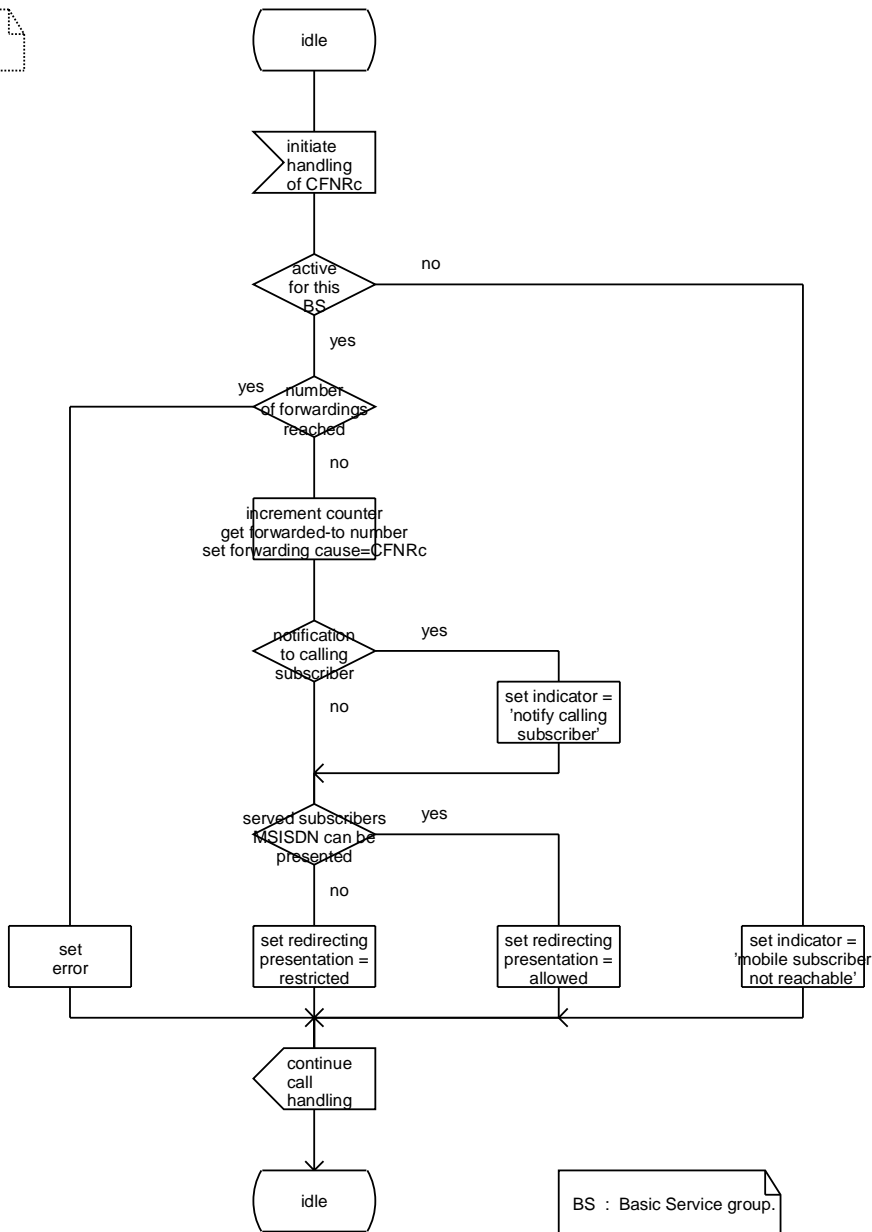

Figure 4.10: MAF010 Call forwarding on mobile subscriber not reachable authorisations examination (VLR and HLR)

1.2.1.2 Behaviour during the "Waiting" State

Expiry of Timer T3

If no acceptance is received by the network within the time period T3 (timer T3 expires) the waiting call shall be forwarded on no reply and clearing shall be initiated towards the controlling user B. The call waiting service is resumed for further incoming calls.

Expiry of Timer T2

If call forwarding on no reply is not active and no acceptance is received within the time period T2 (timer T2 expires), the waiting call shall be cleared by the network towards the controlling user B and the calling user C. The call waiting service is resumed for further incoming calls.

Other Events

The following events are treated as described in subclause 1.2.1.1:

- release of active call;
- release of call by user C;
- call hold service;
- indication of UDUB;
- rejection of call from user C.

Acceptance of waiting call

A precondition for the acceptance of the waiting call is that there is no other call in the (active, idle) state. The user can achieve this by releasing active calls, or using the call hold service. When user B accepts the call from user C it becomes the (active, idle) call. Timer T2 or T3 is stopped. The call waiting service is resumed for further incoming calls.

Process MAF013

383_14(1)

Figure 1.4

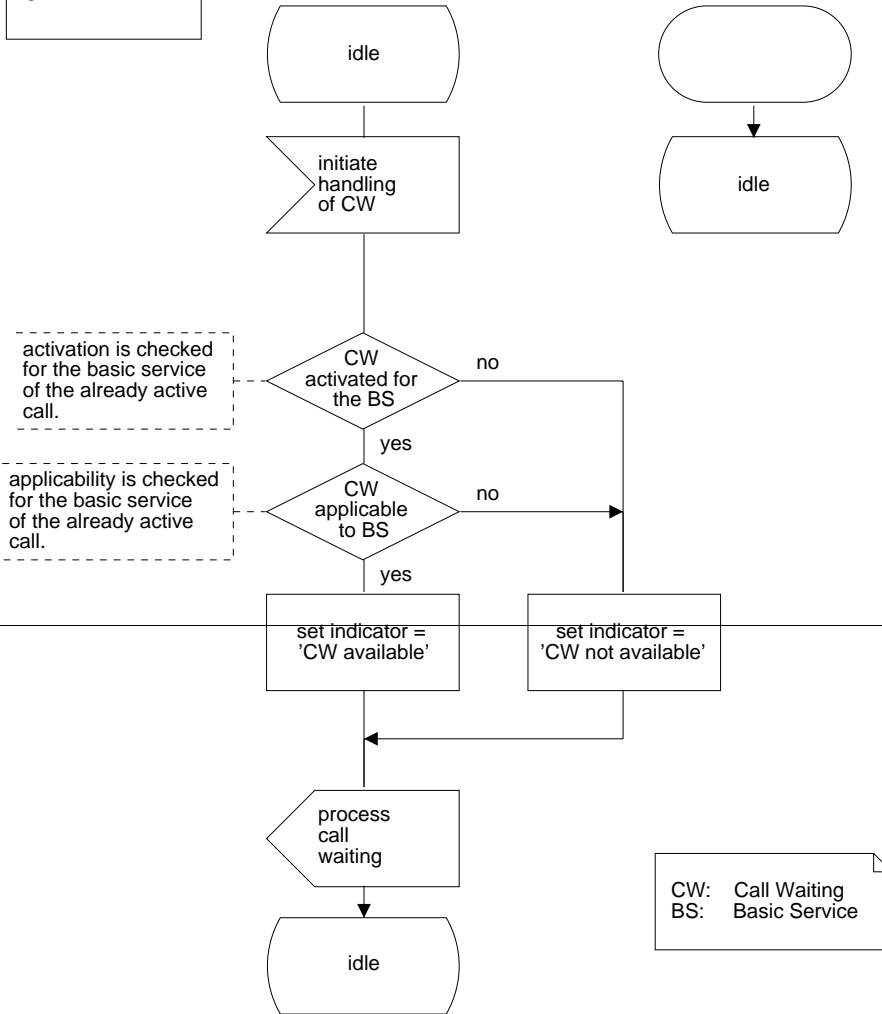

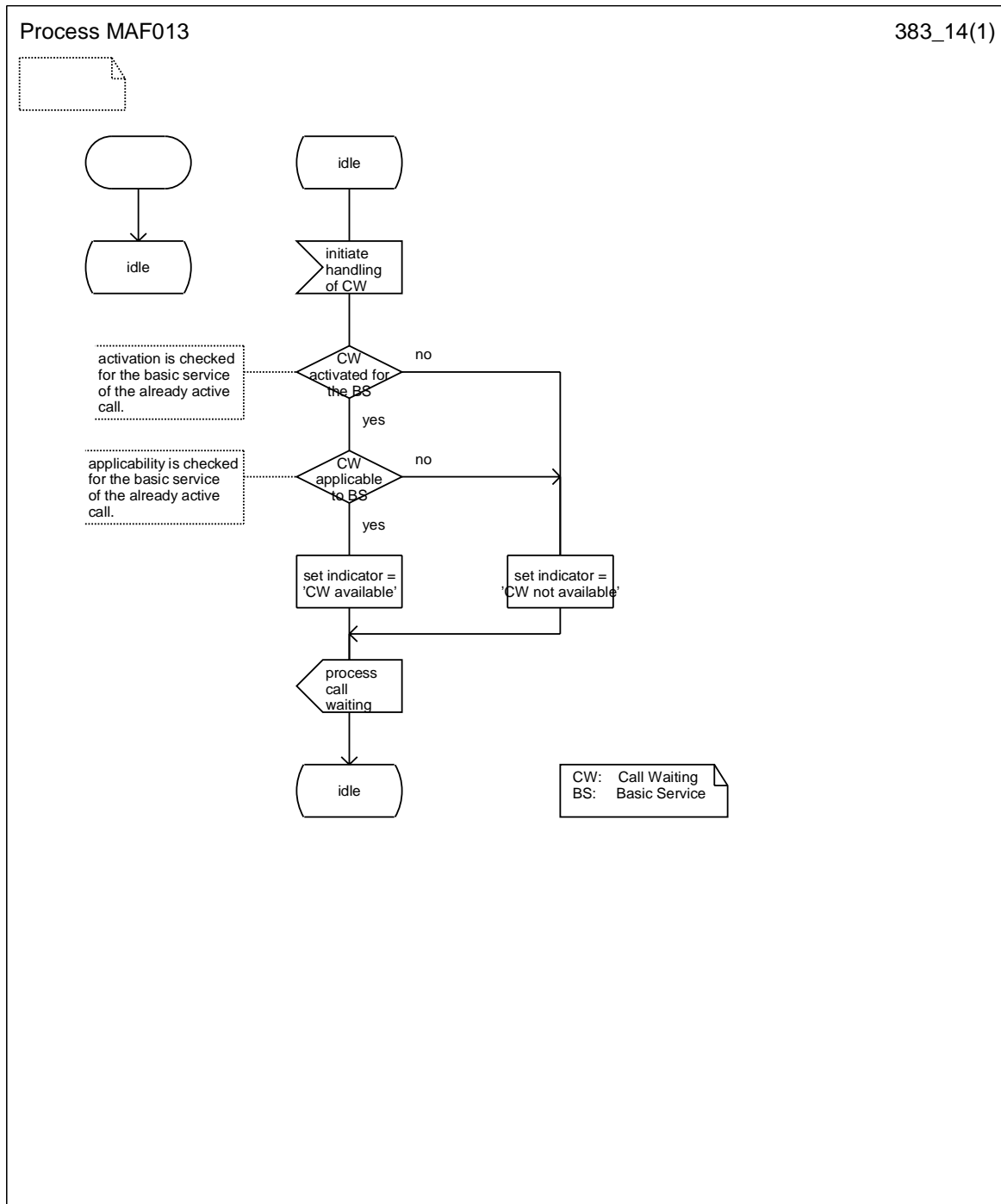
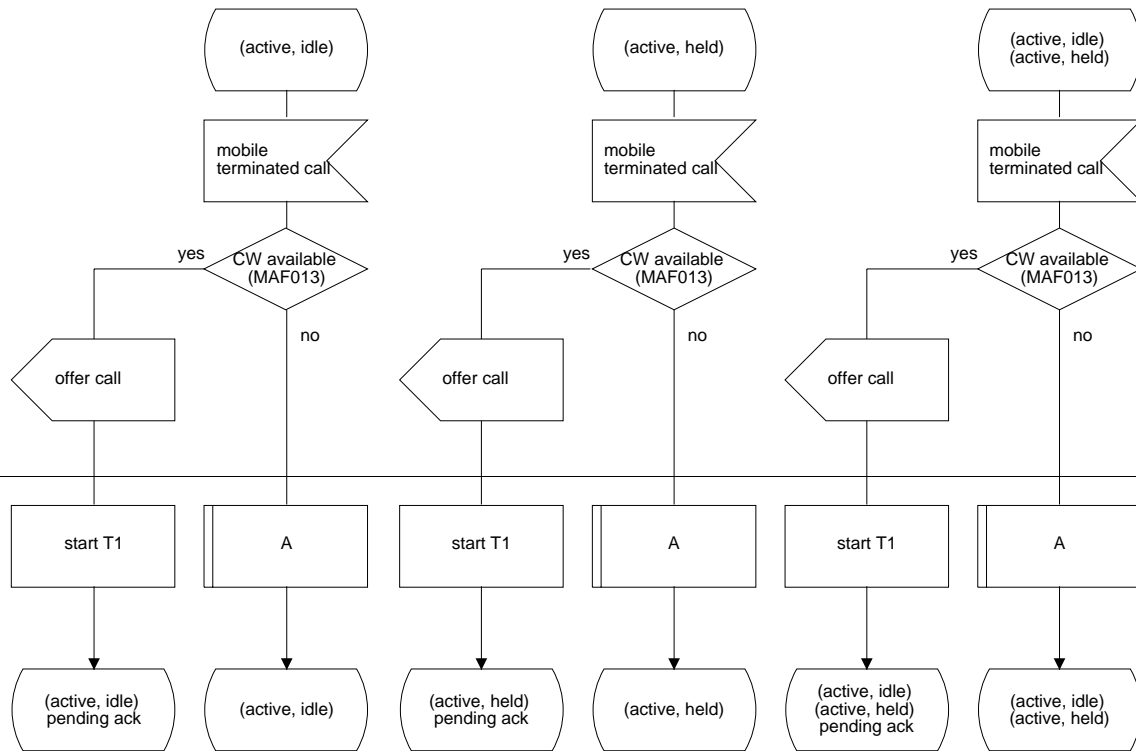

Figure 1.4: MAF013 Call waiting related authorisations examination (VLR)

Process Call_Waiting

383_151(9)

Figure 1.5 (sheet 1 of 10)



- Messages to/from left refer to the radio interface.
 - Messages to/from right refer to the network interface.
 - Clearing of active calls by a remote subscriber is not shown for clarity.
 Moreover, this is possible and is described in the text.

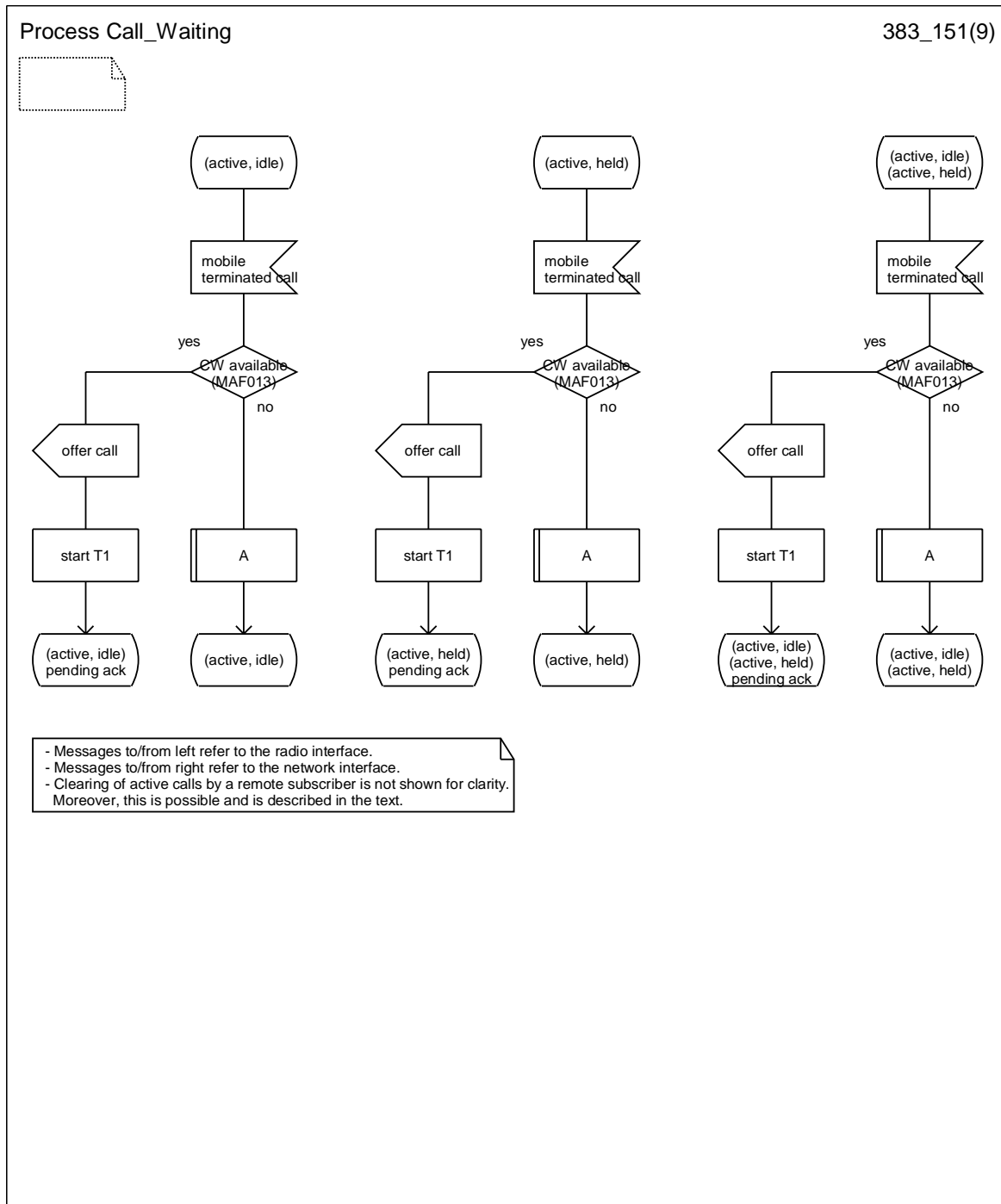
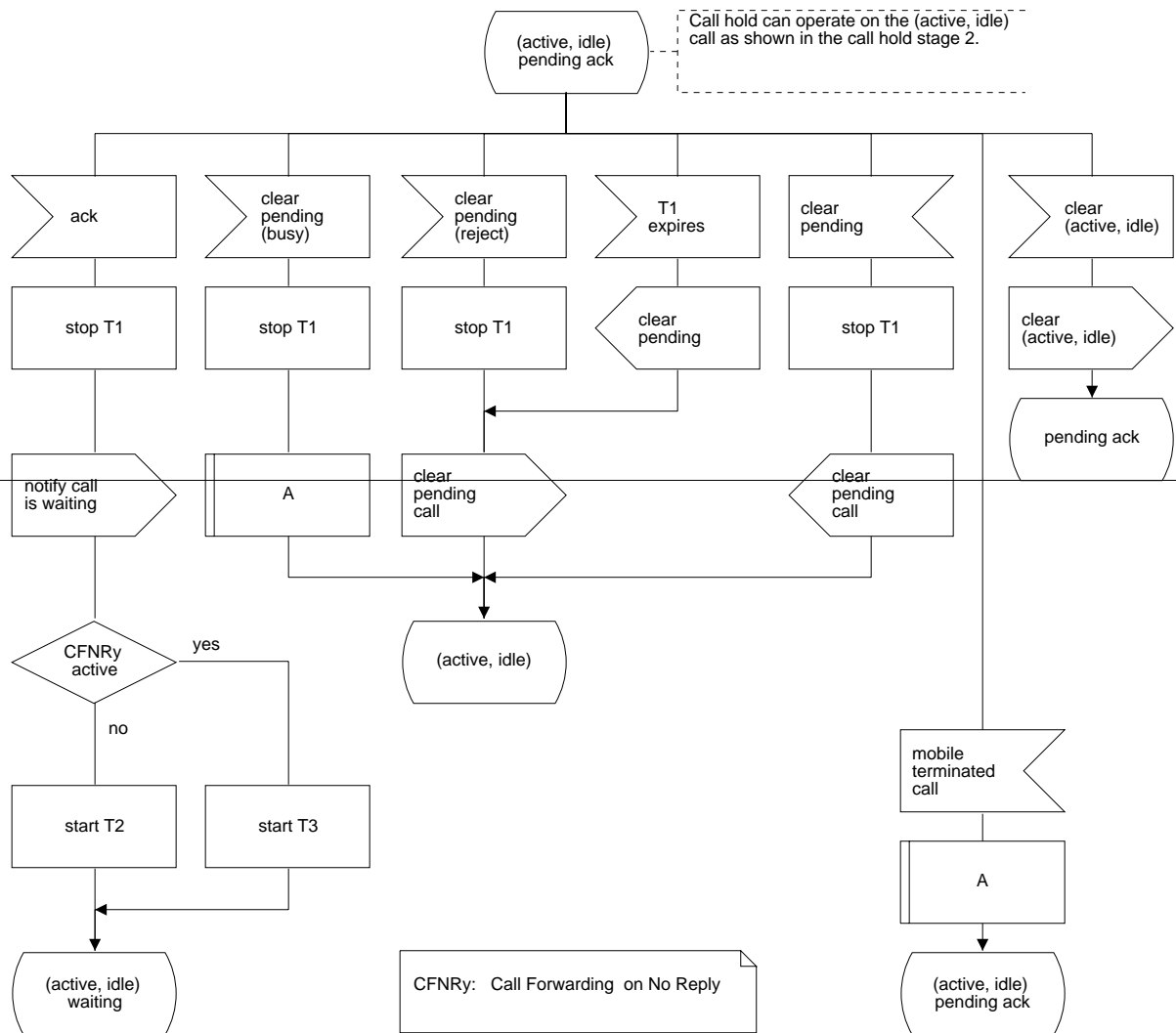

Figure 1.5 (sheet 1 of 10): Overall SDL diagram of call waiting

Process Call_Waiting

383_152(9)

Figure 1.5 (sheet 2 of 10)



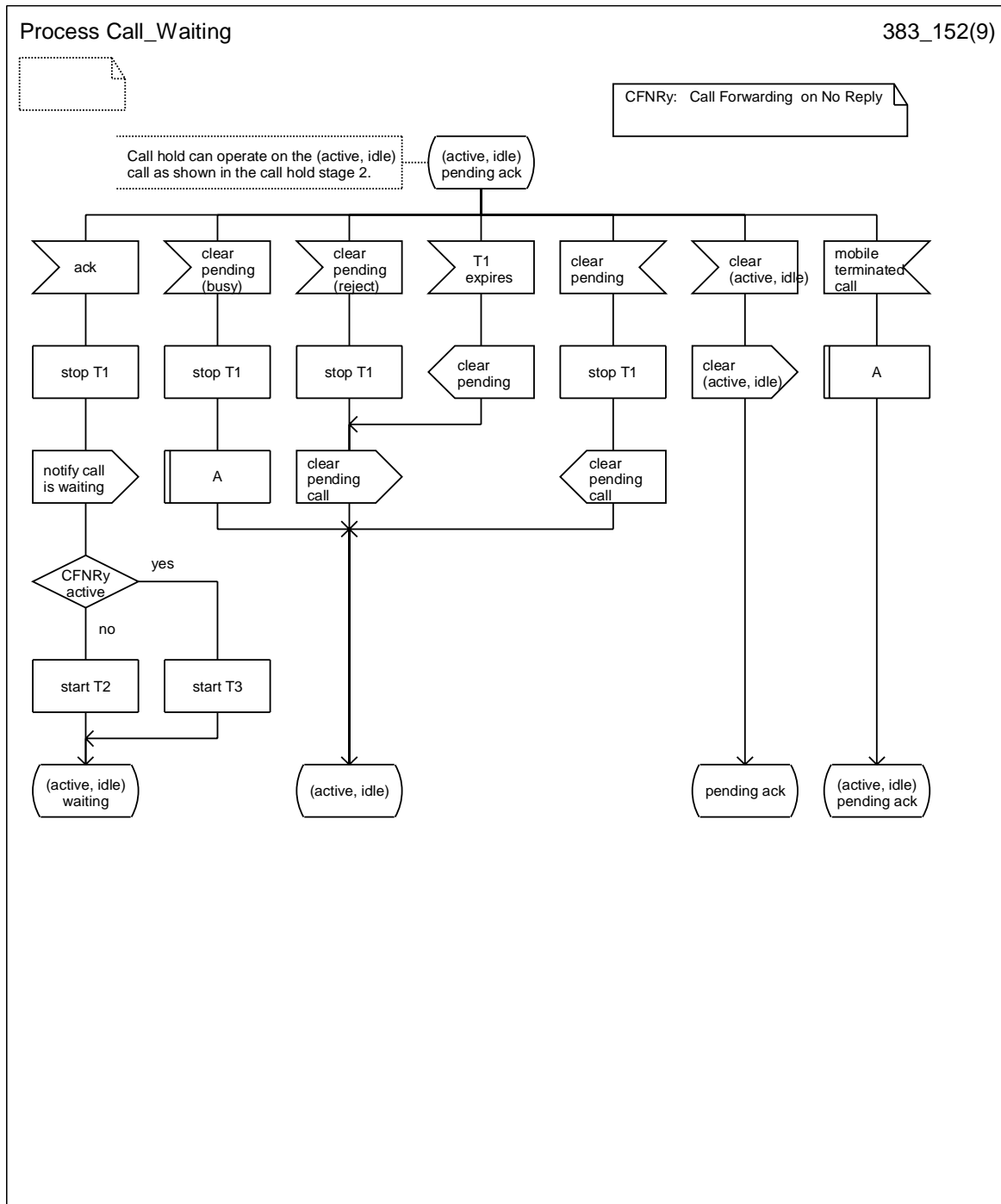
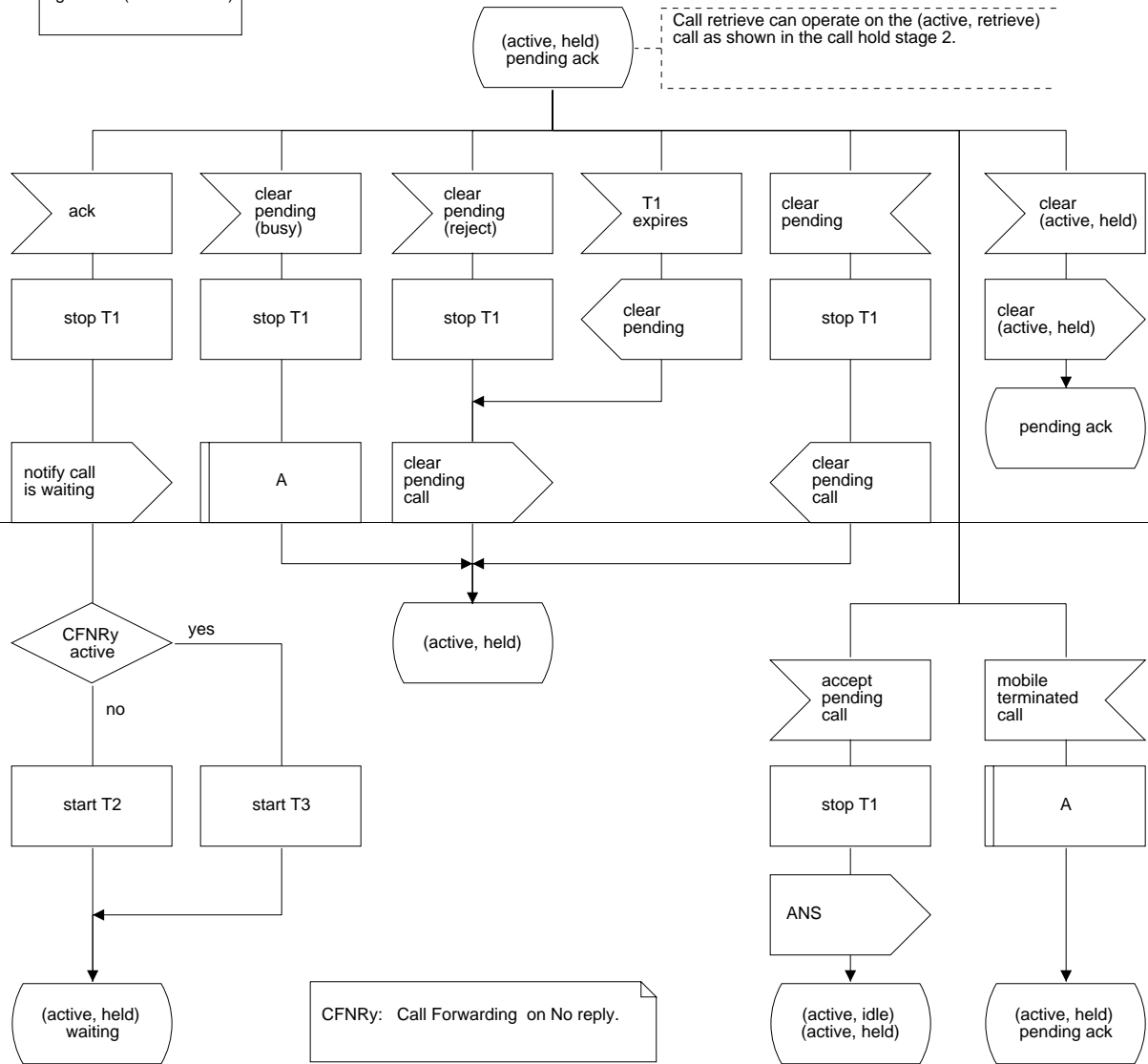

Figure 1.5 (sheet 2 of 10): Overall SDL diagram of call waiting

Process Call_Waiting

383_153(9)

Figure 1.5 (sheet 3 of 10)



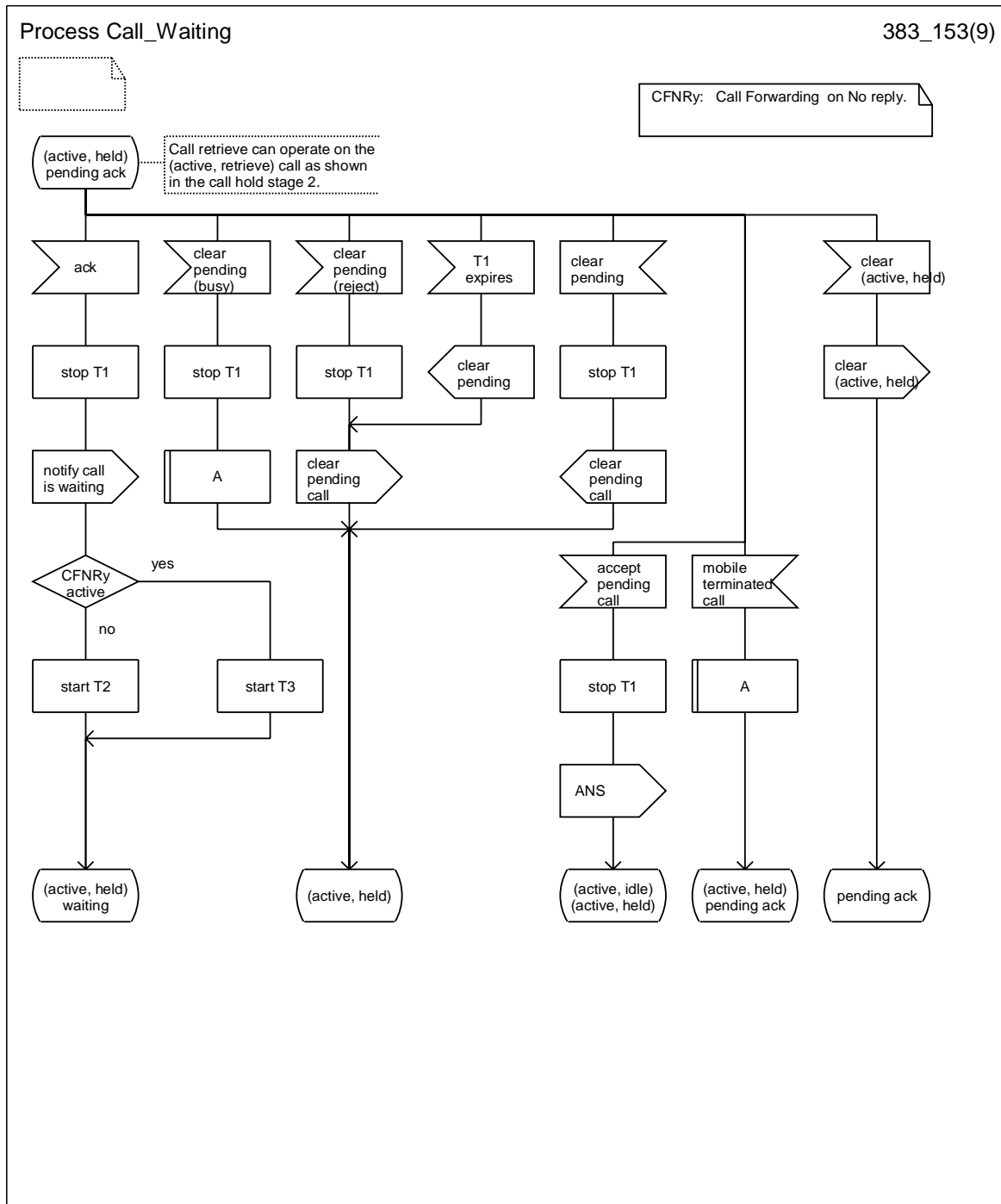
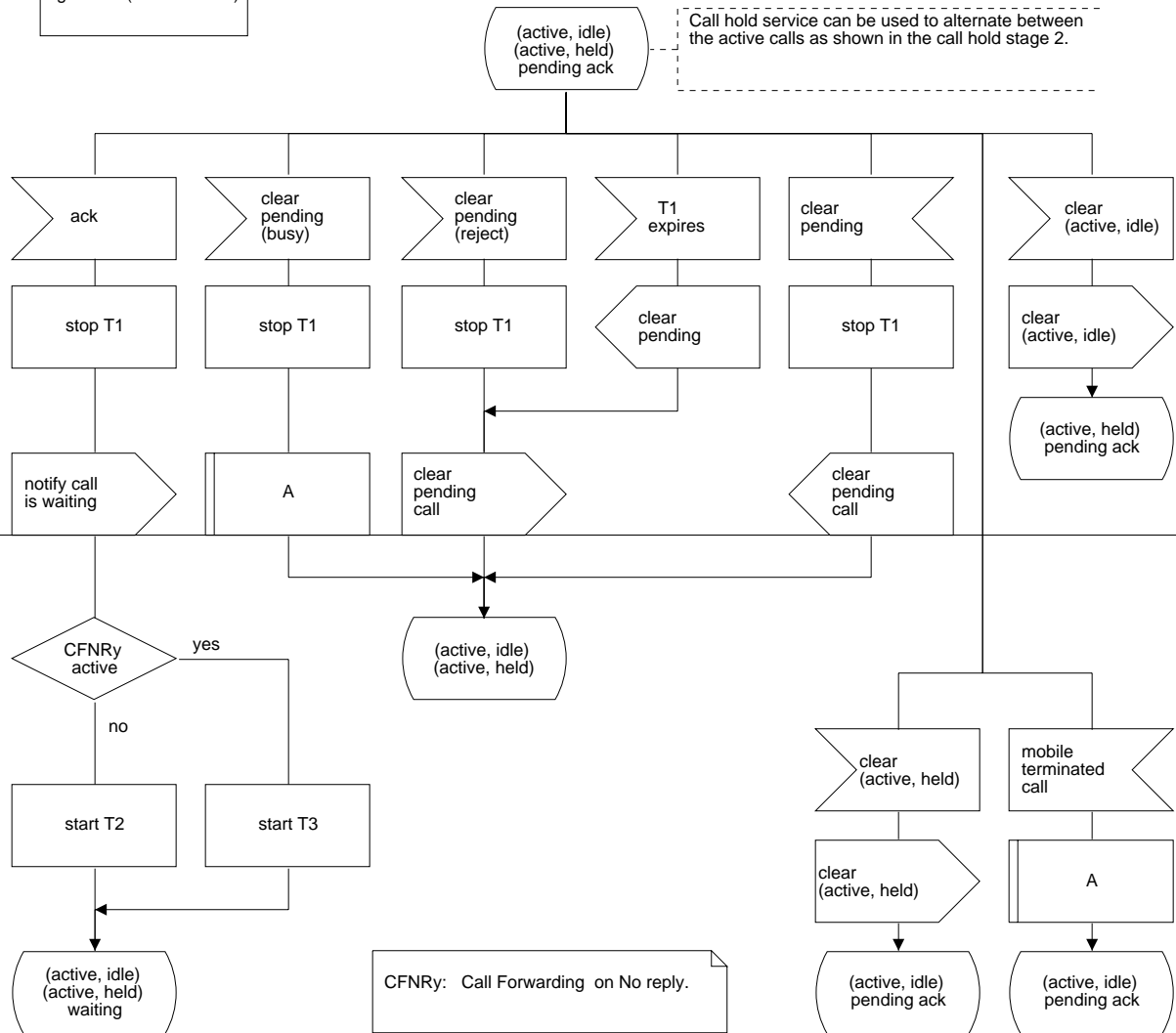

Figure 1.5 (sheet 3 of 10): Overall SDL diagram of call waiting

Process Call_Waiting

383_154(9)

Figure 1.5 (sheet 4 of 10)



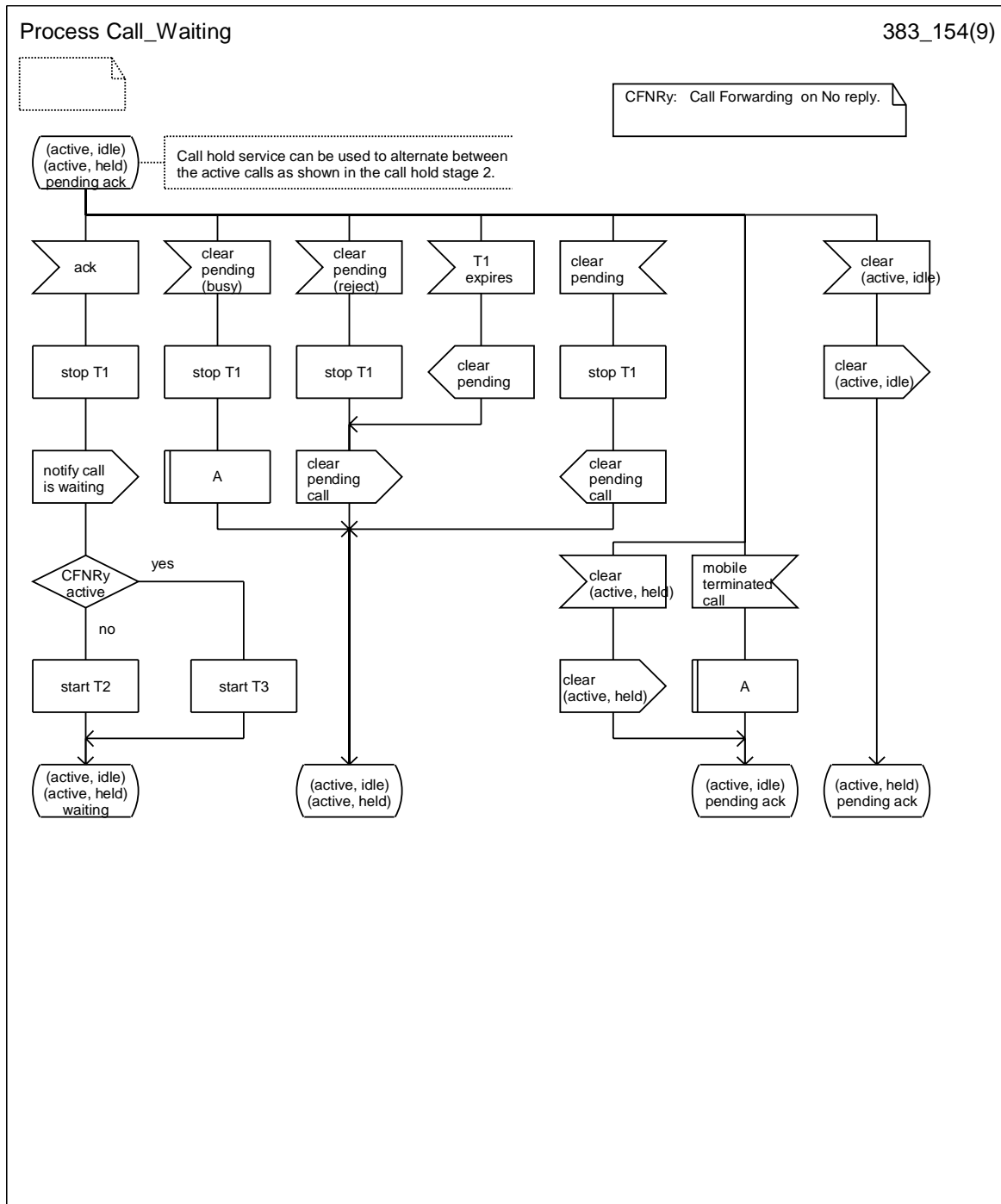
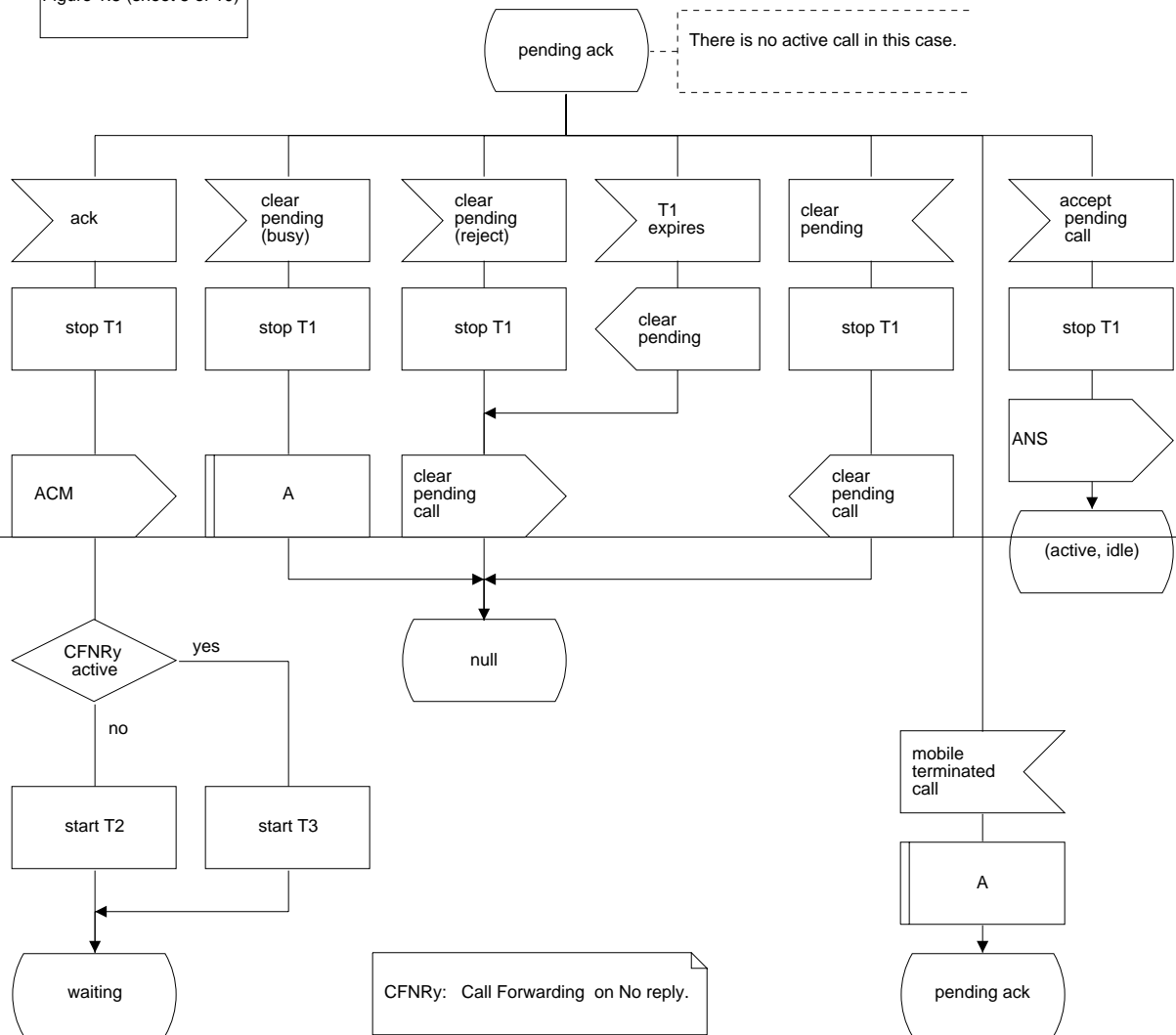

Figure 1.5 (sheet 4 of 10): Overall SDL diagram of call waiting

Process Call_Waiting

383_155(9)

Figure 1.5 (sheet 5 of 10)



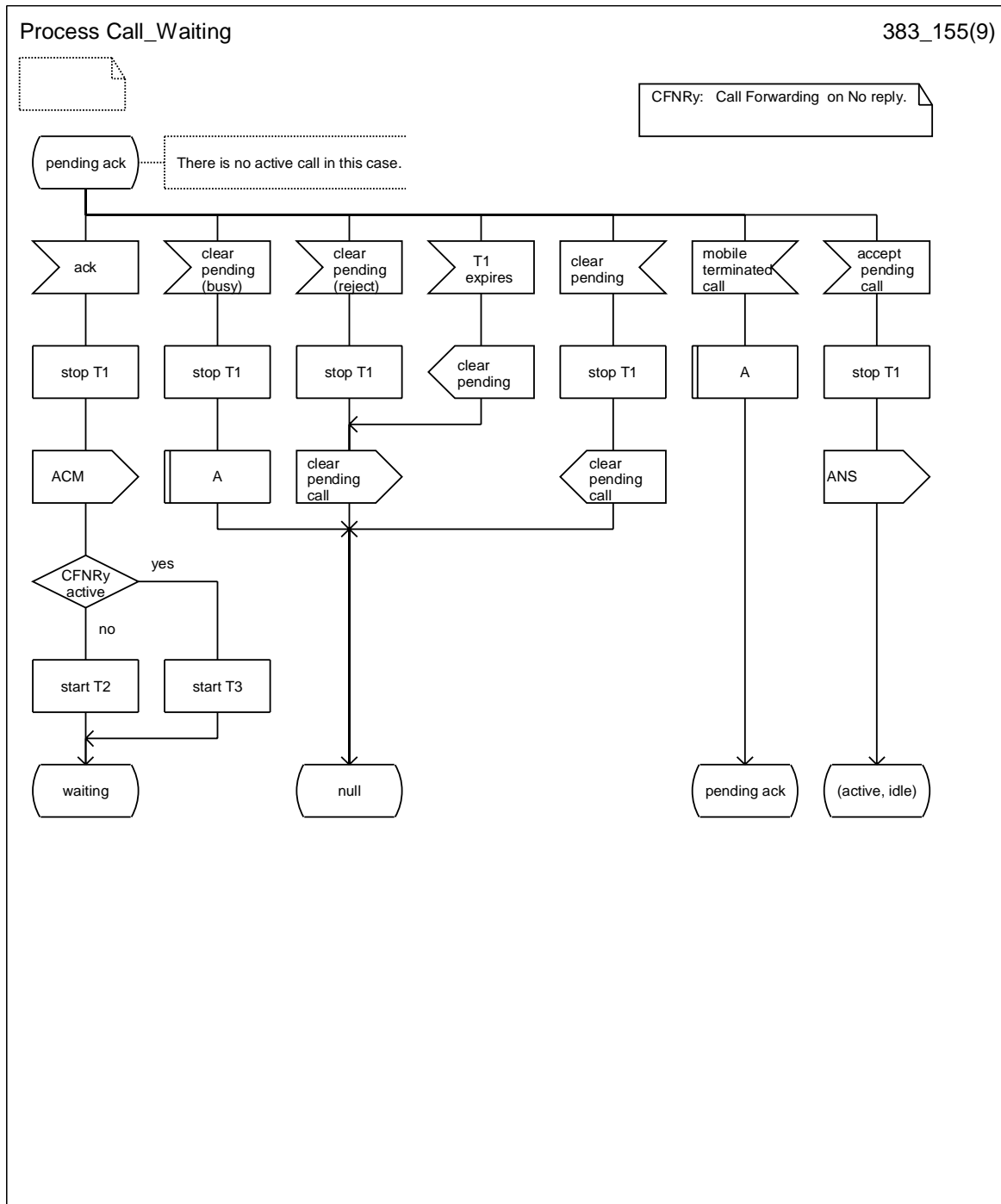
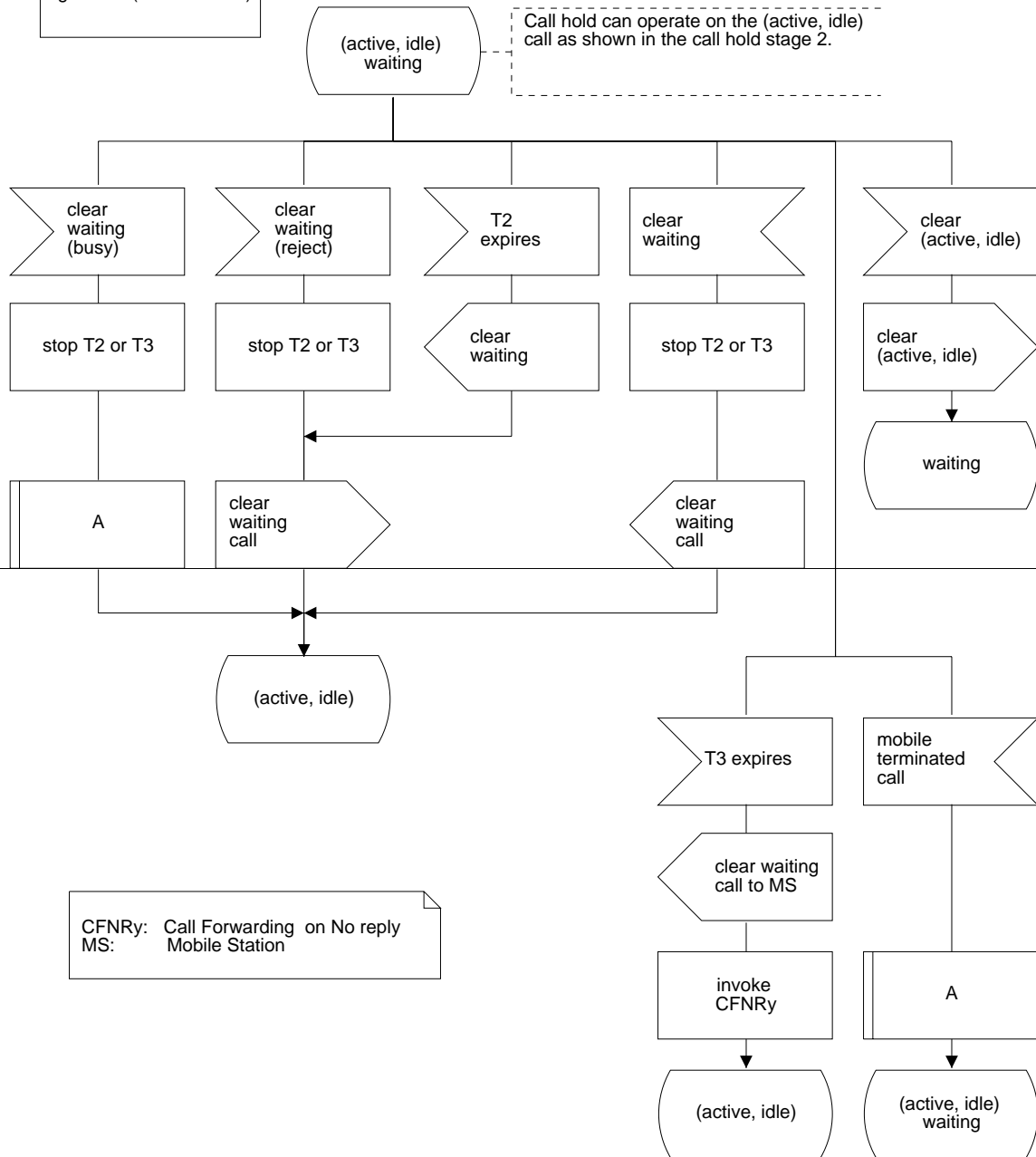

Figure 1.5 (sheet 5 of 10): Overall SDL diagram of call waiting

Process Call_Waiting

383_156(9)

Figure 1.5 (sheet 6 of 10)



CFNRy: Call Forwarding on No reply
MS: Mobile Station

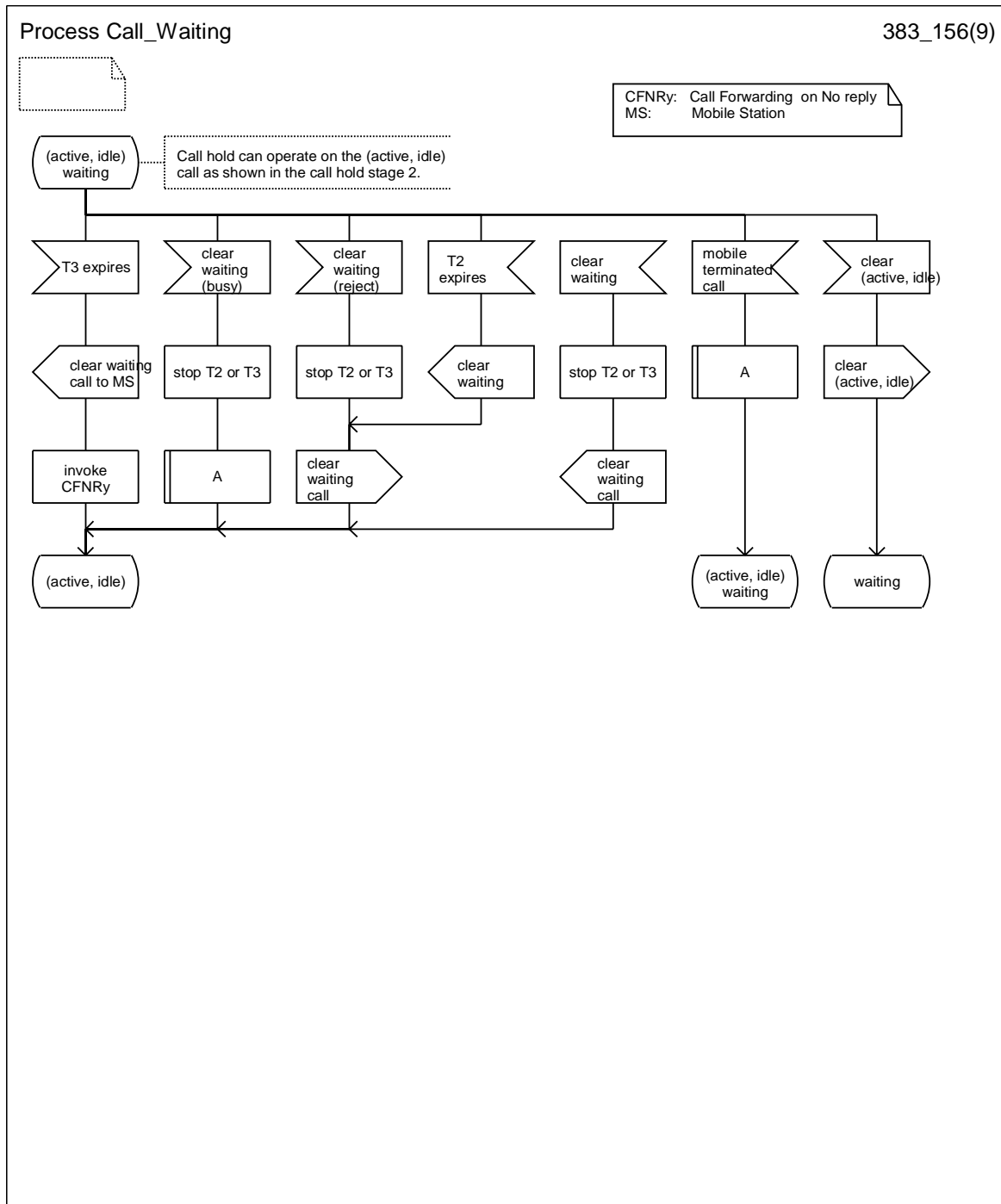
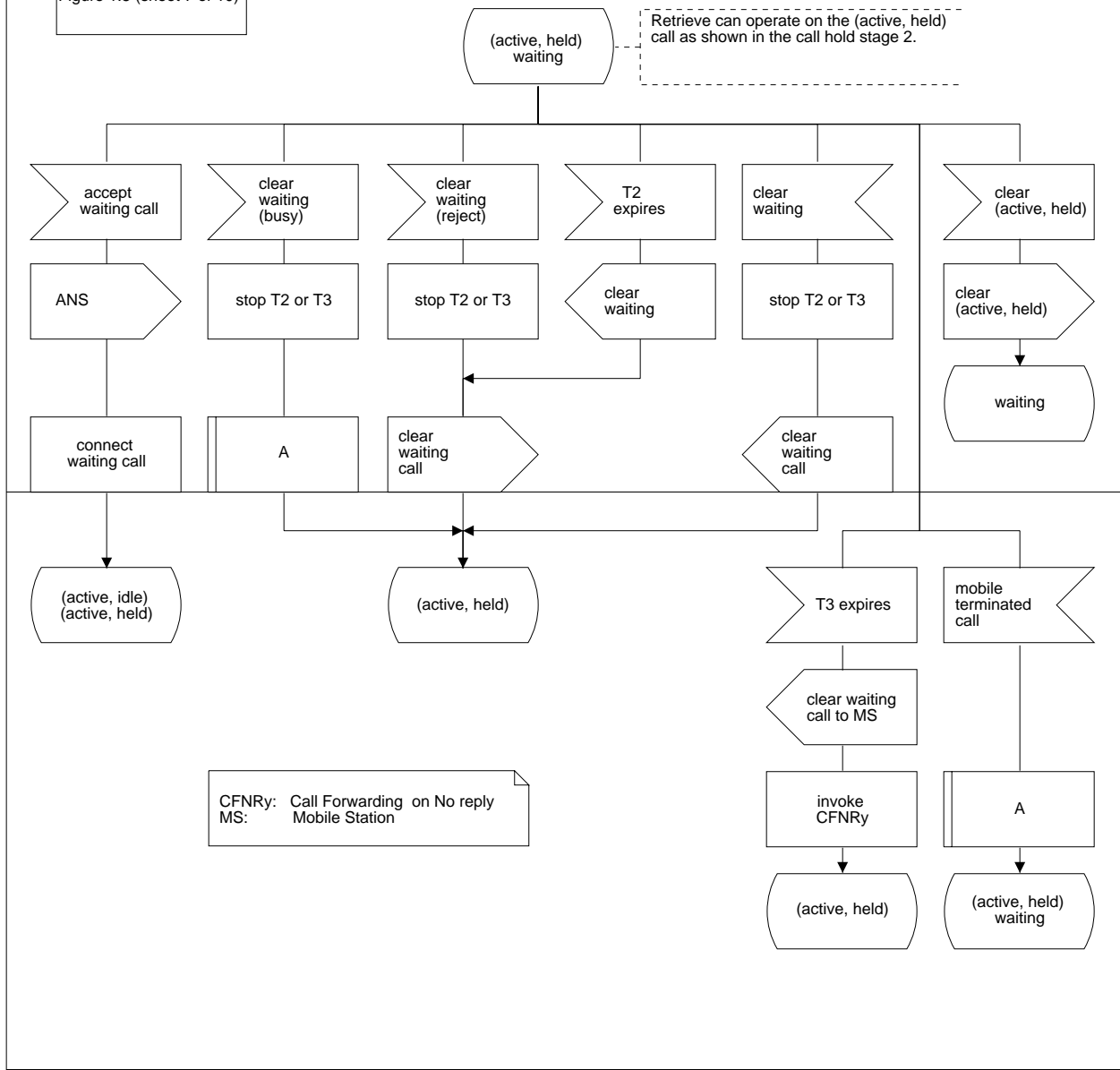

Figure 1.5 (sheet 6 of 10): Overall SDL diagram of call waiting

Process Call_Waiting

383_157(9)

Figure 1.5 (sheet 7 of 10)



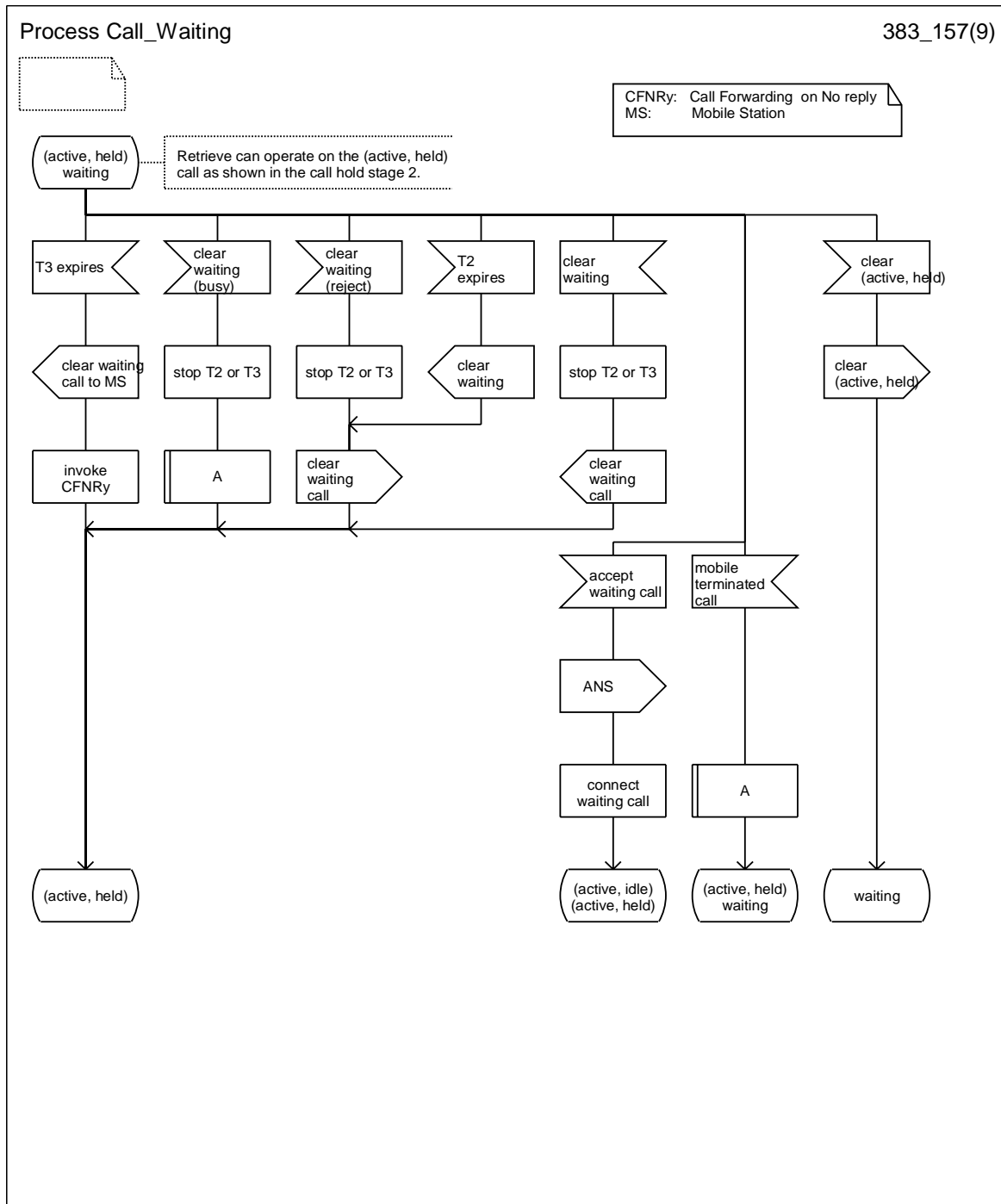
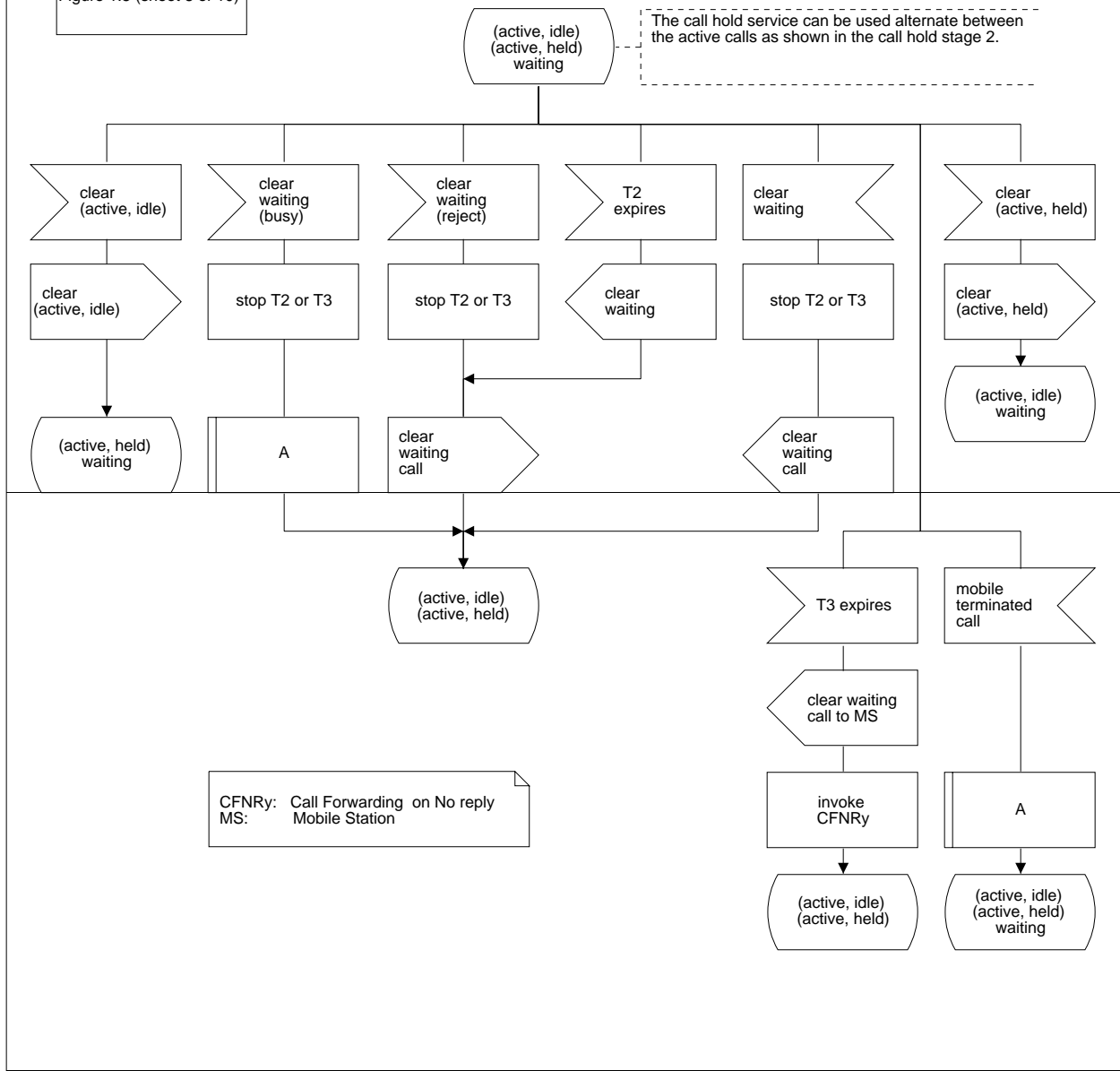

Figure 1.5 (sheet 7 of 10): Overall SDL diagram of call waiting

Process Call_Waiting

383_158(9)

Figure 1.5 (sheet 8 of 10)



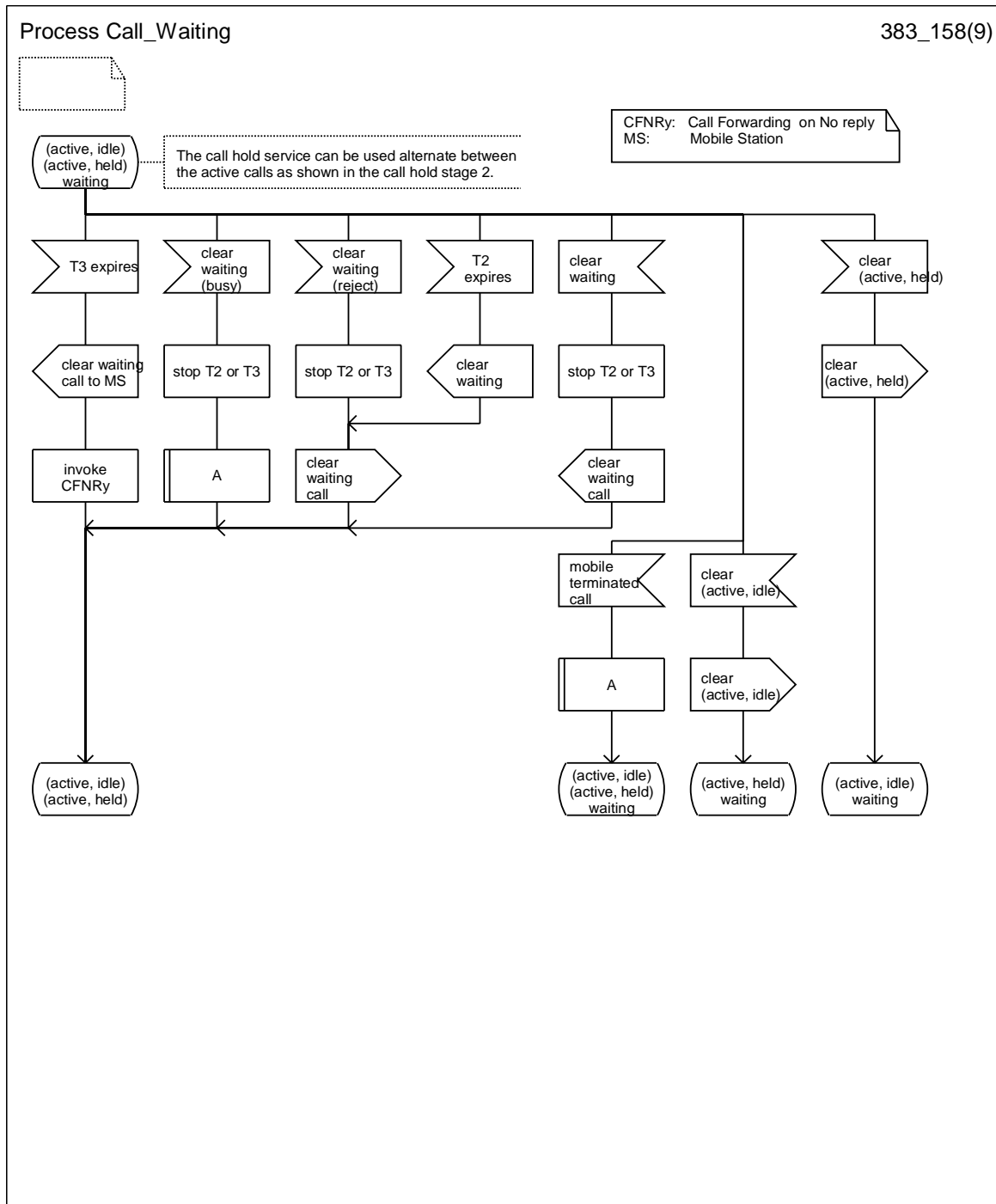
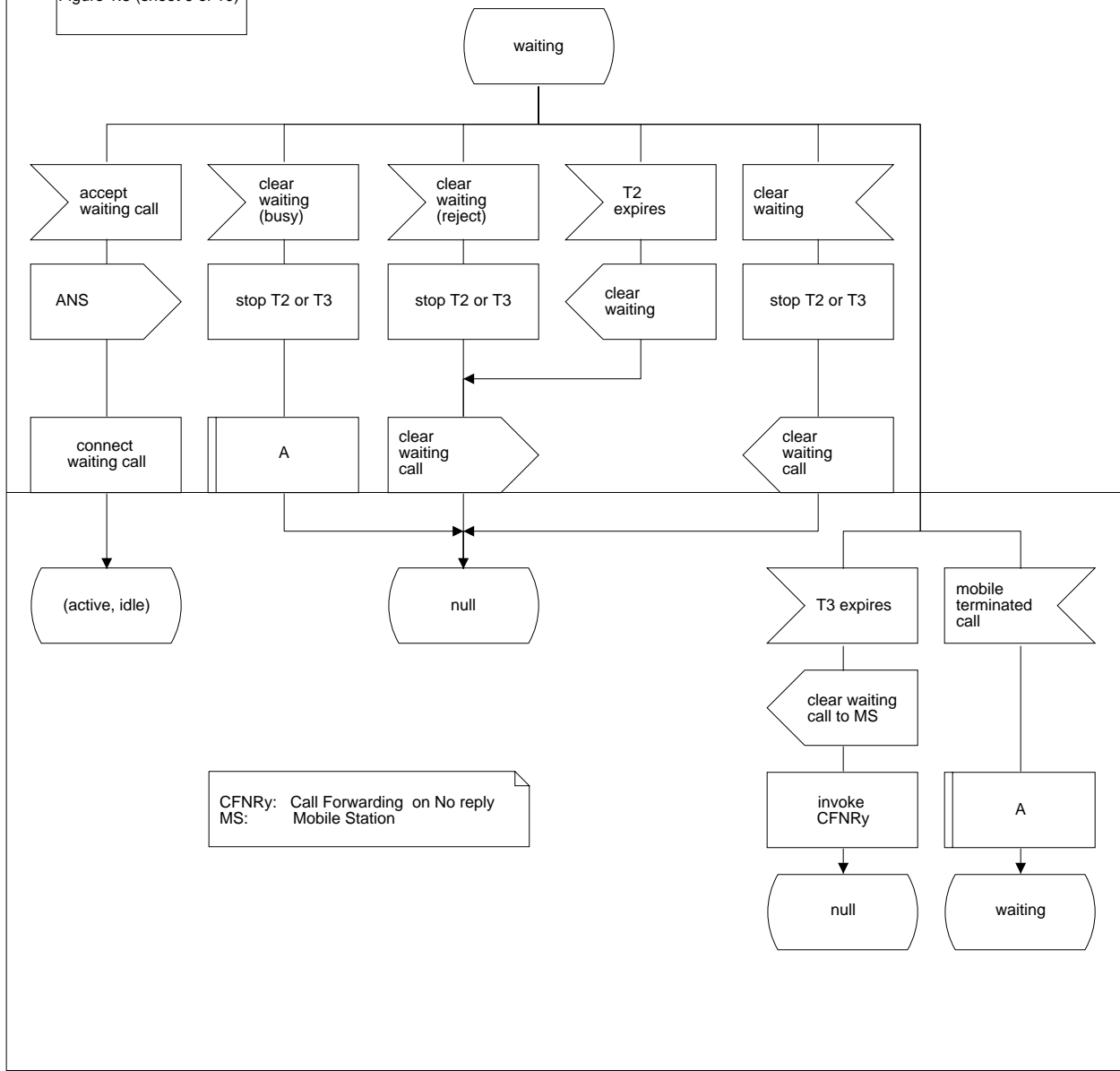

Figure 1.5 (sheet 8 of 10): Overall SDL diagram of call waiting

Process Call_Waiting

383_159(9)

Figure 1.5 (sheet 9 of 10)



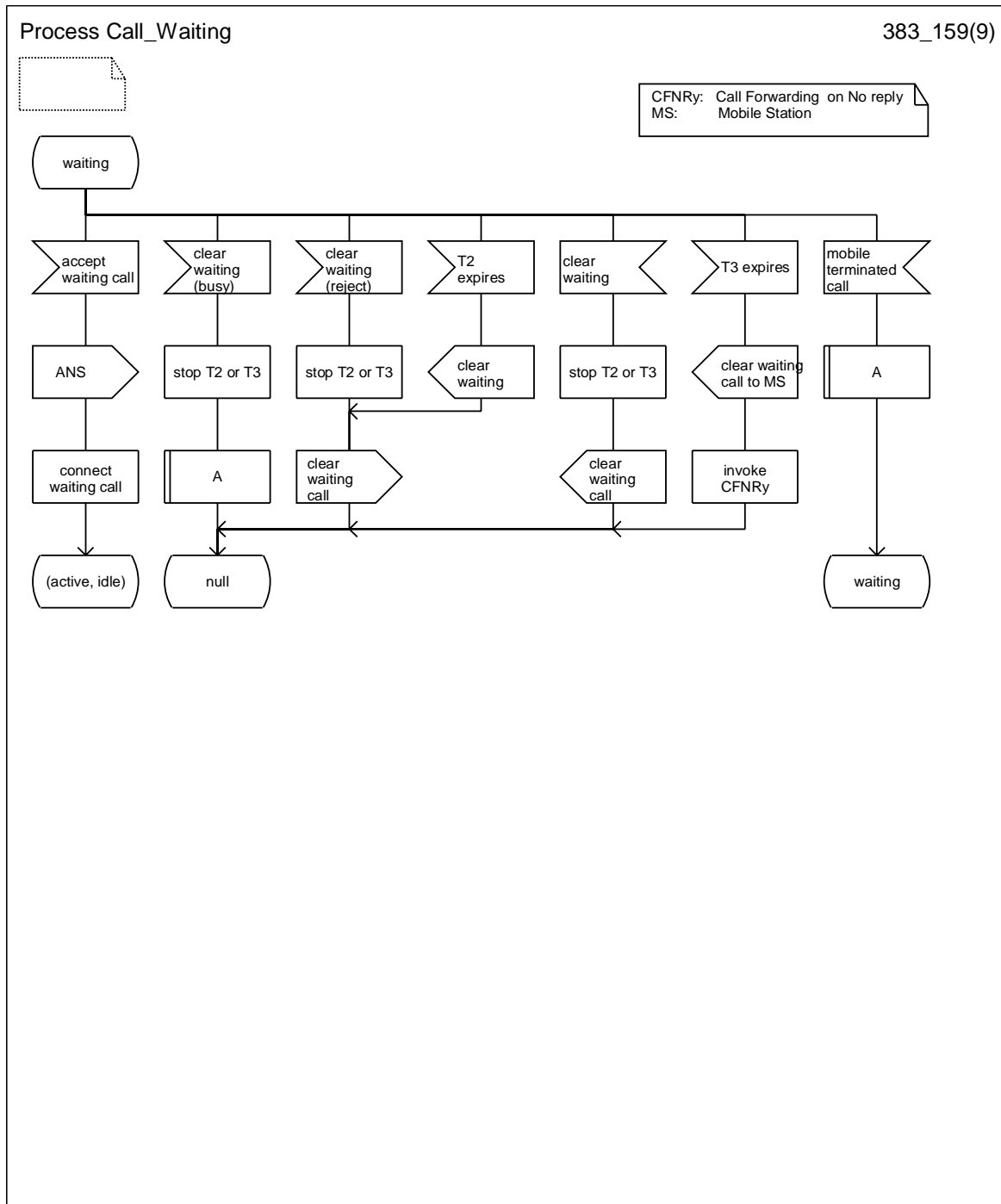
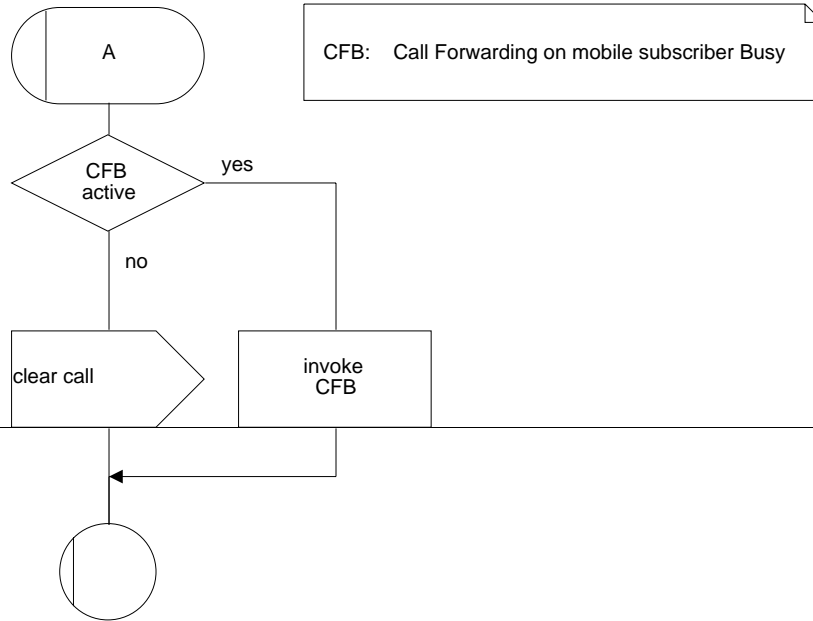

Figure 1.5 (sheet 9 of 10): Overall SDL diagram of call waiting

Macro CW_Macro_A

383_15A(1)

Figure 1.5 (sheet 10 of 10)



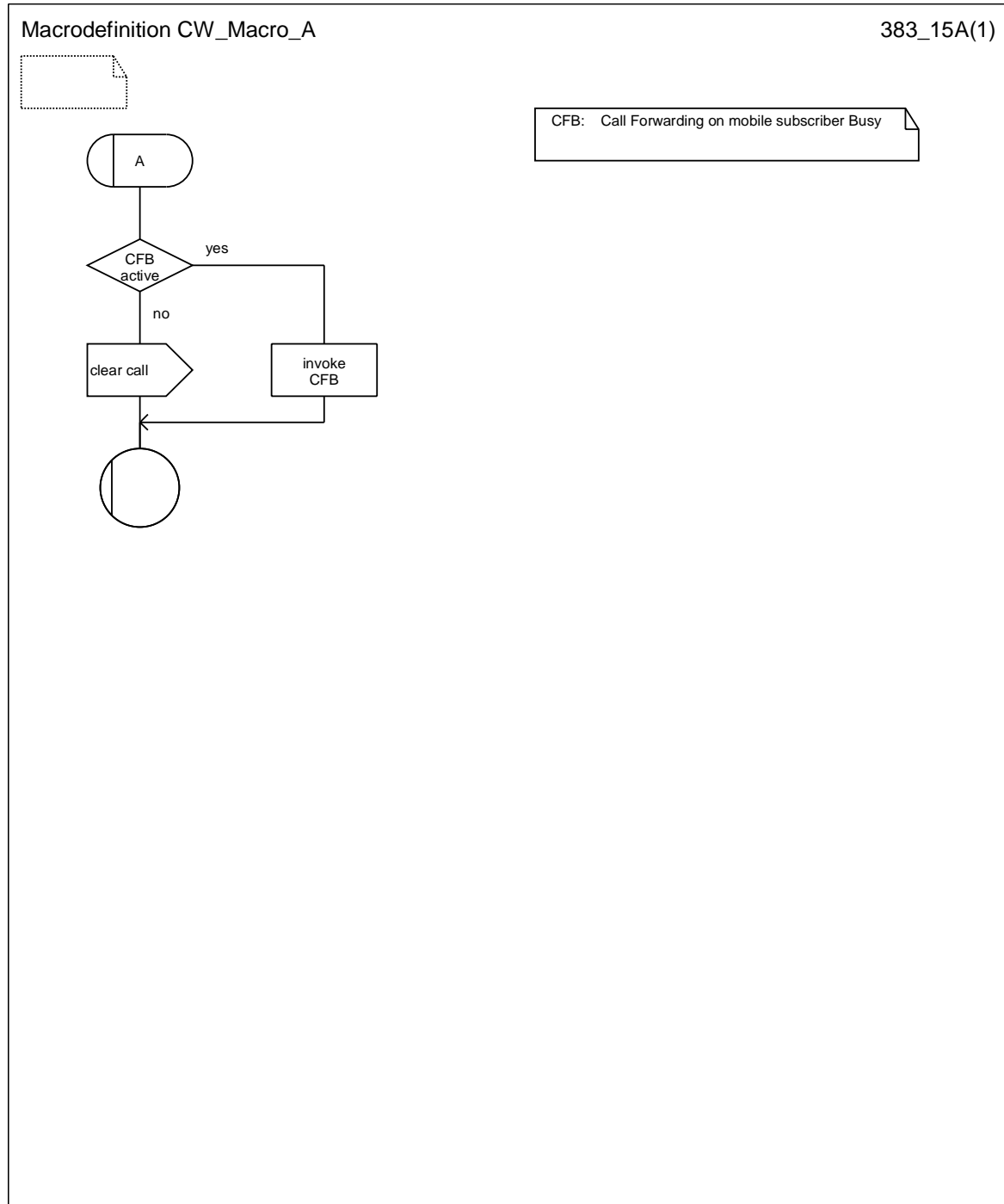
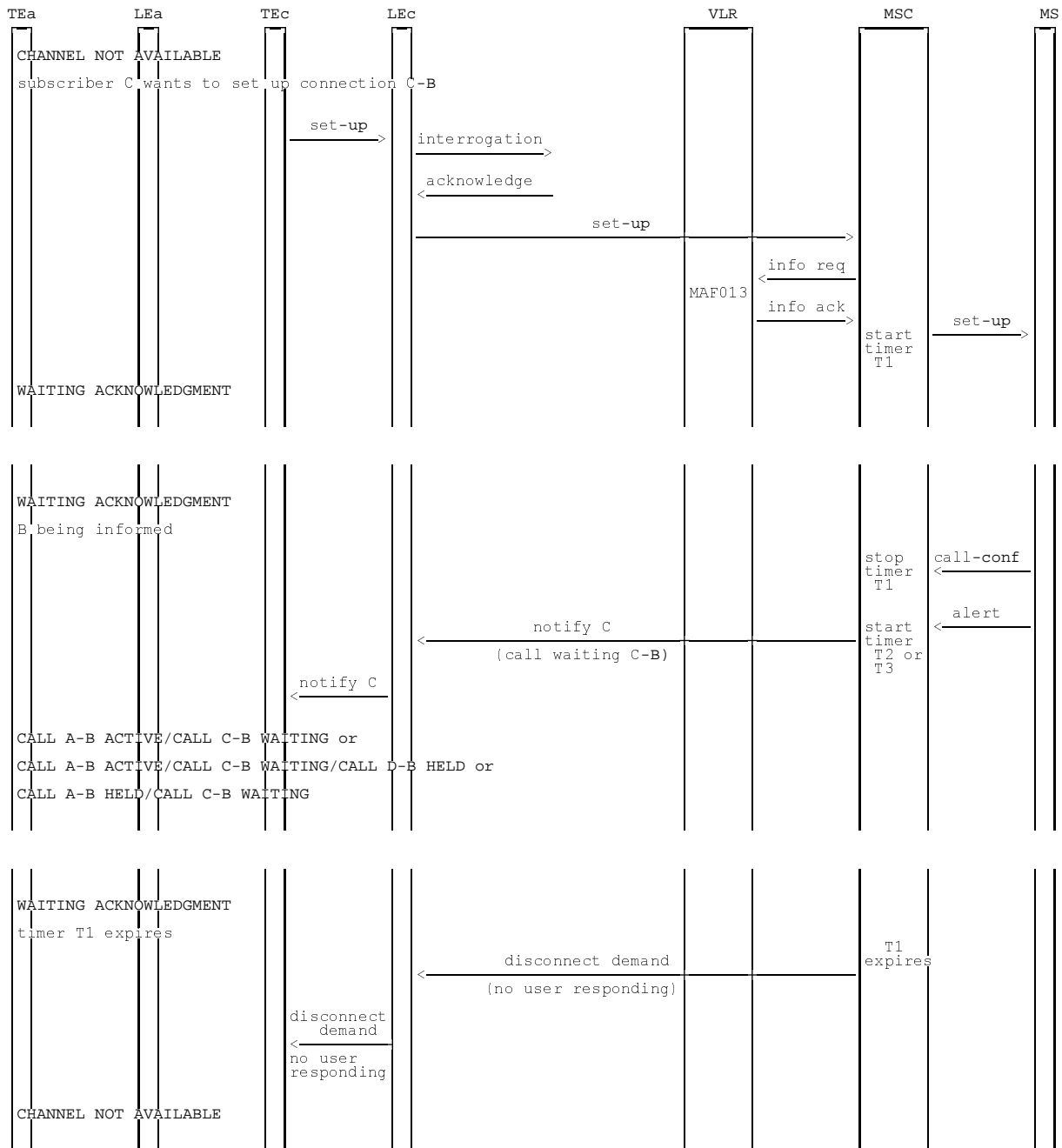
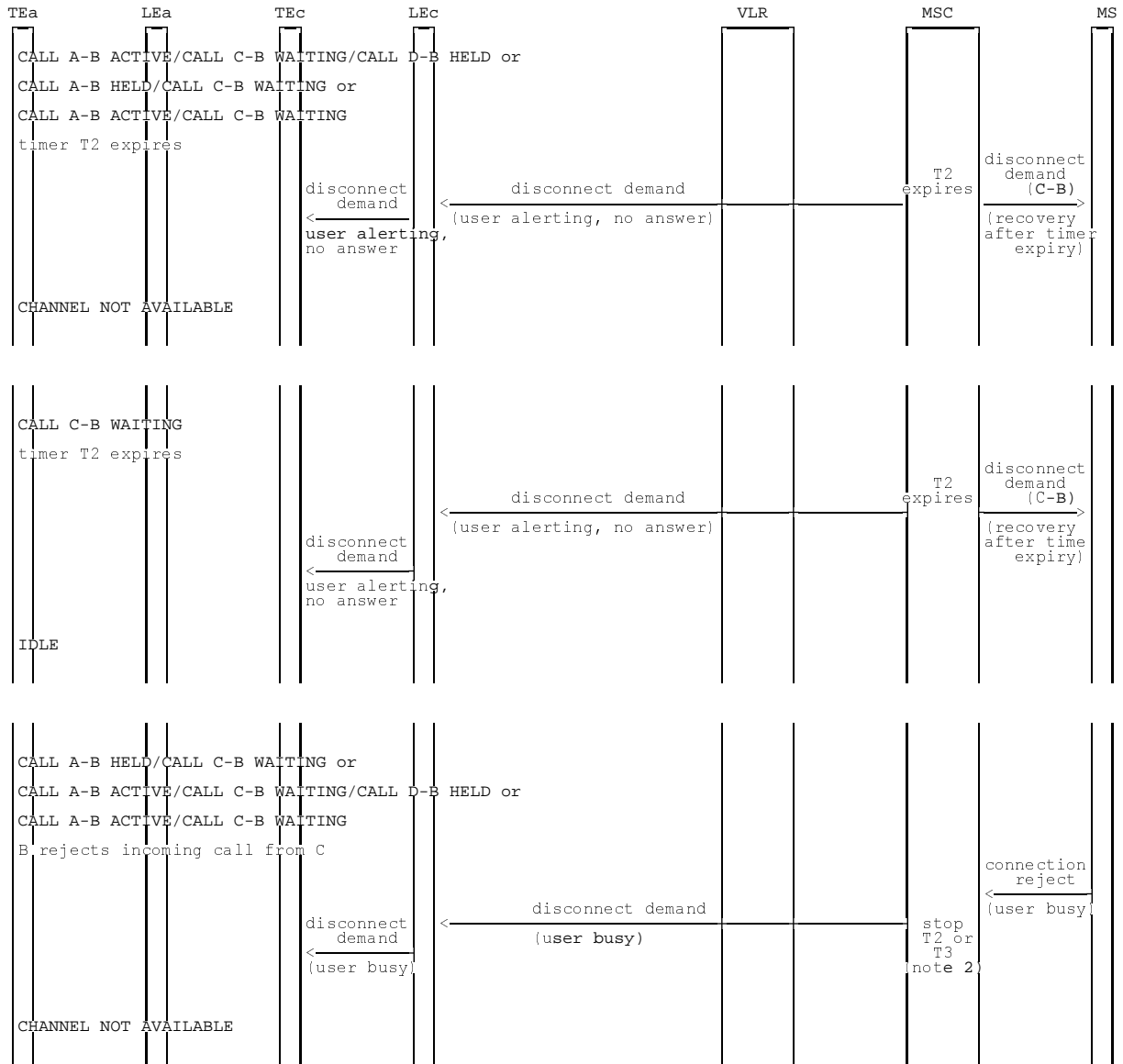

Figure 1.5 (sheet 10 of 10): Overall SDL diagram of call waiting



NOTE 1: info req: information request
info ack: information acknowledge

Figure 1.6 (sheet 1 of 7): Information flow for call waiting



NOTE 2: The call shall be forwarded on mobile subscriber busy at this stage if activated.

Figure 1.6 (sheet 2 of 7): Information flow for call waiting

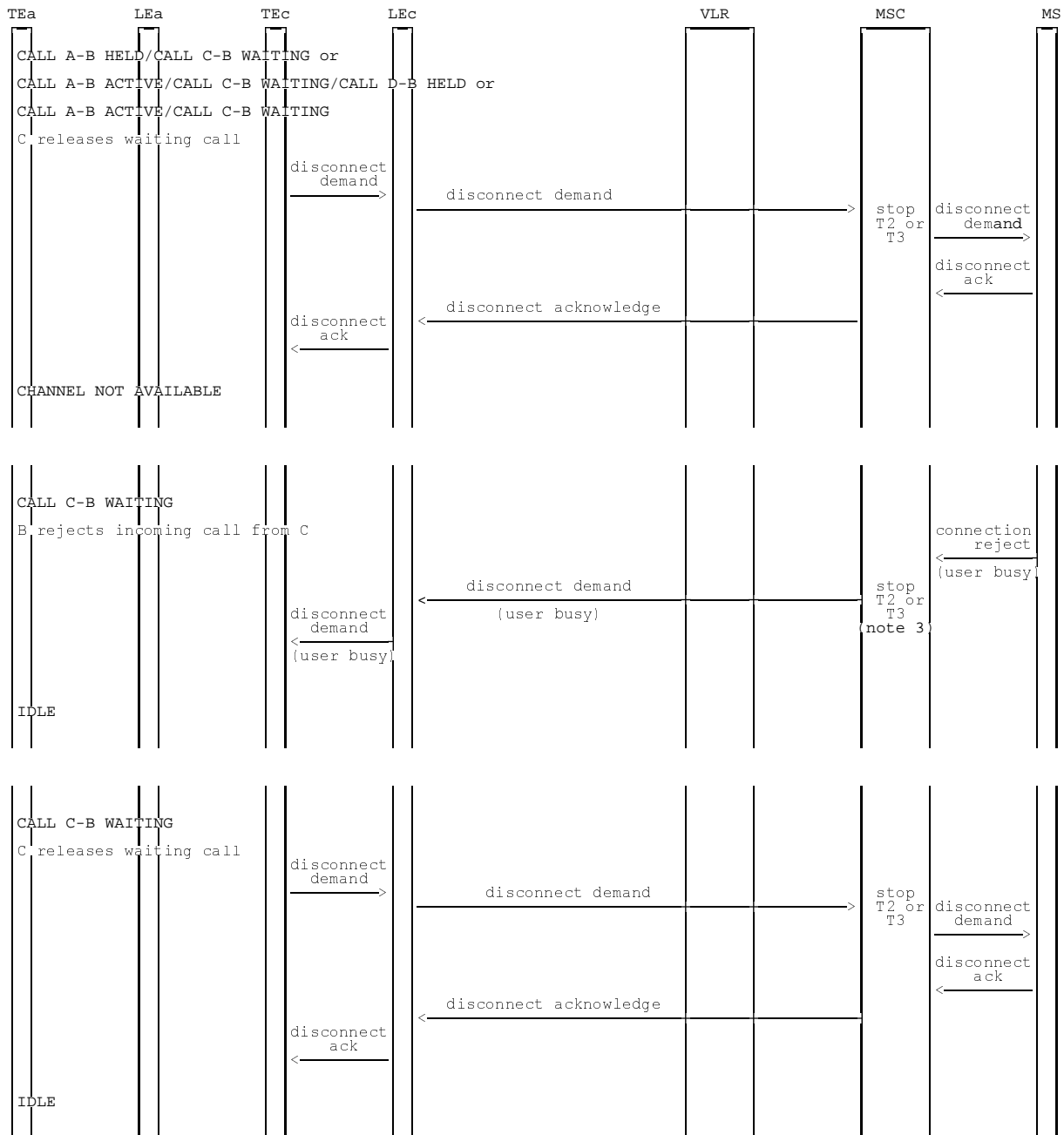

NOTE 3: The call shall be forwarded on mobile subscriber busy at this stage if activated.

Figure 1.6 (sheet 3 of 7): Information flow for call waiting

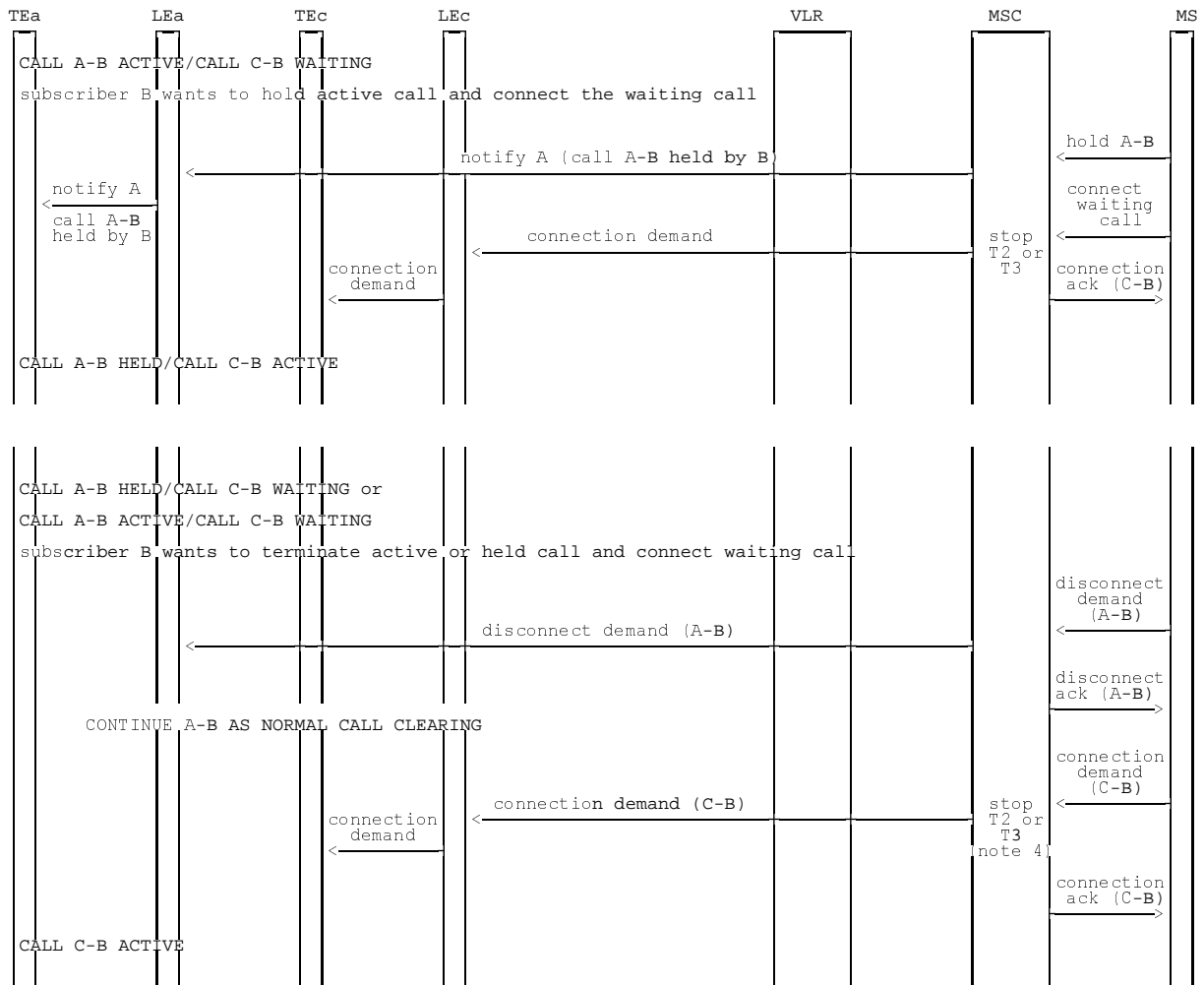

NOTE 4: If T2 or if applicable T3 expires before reception of connection demand in the MSC then call c-b shall be released with cause no reply and if it was T3 which expired the waiting call from C shall be forwarded on no reply.

Figure 1.6 (sheet 4 of 7): Information flow for call waiting

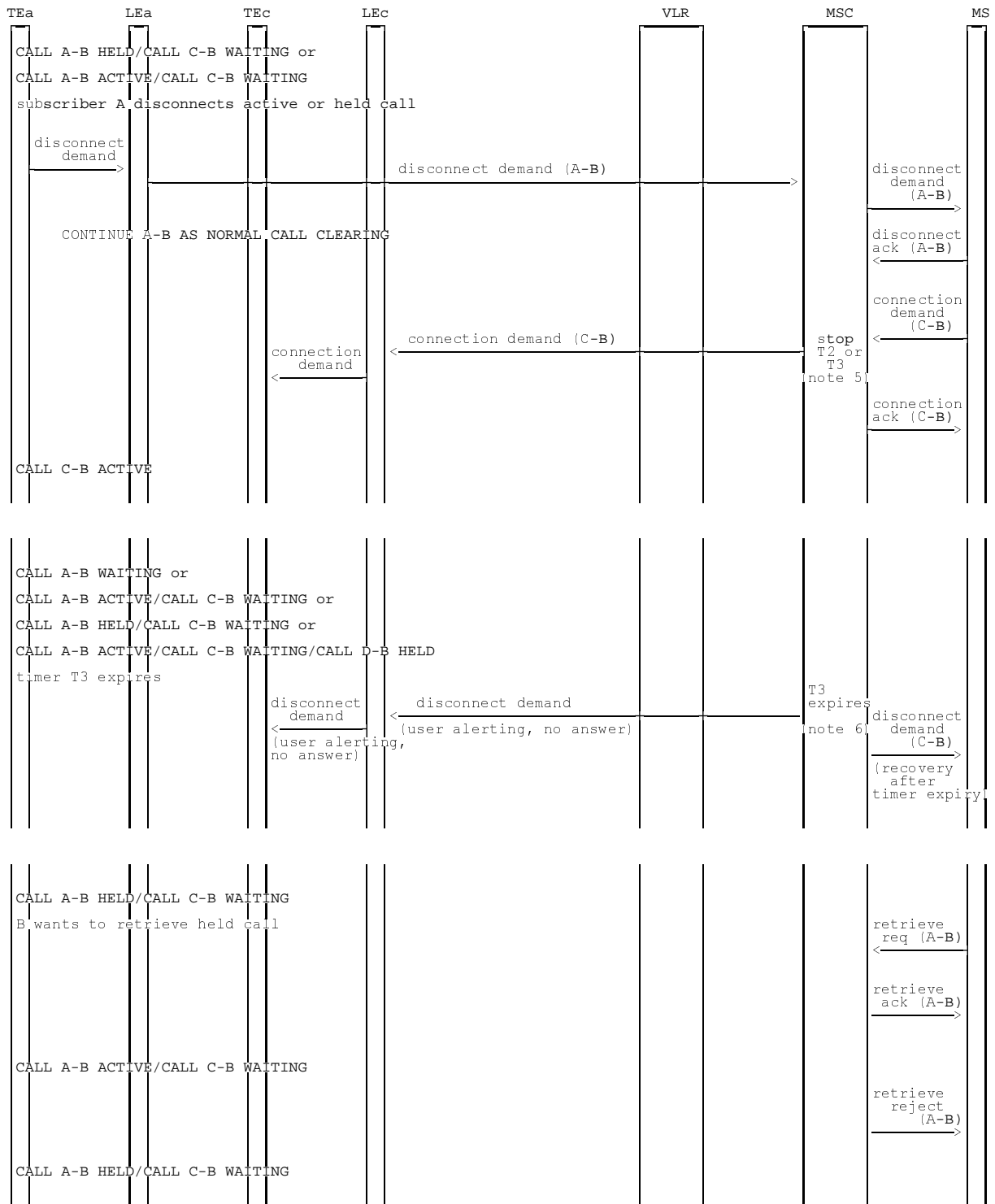

NOTE 5: The call shall be forwarded on mobile subscriber busy at this stage if activated.

NOTE 6: The call shall be forwarded on no reply.

Figure 1.6 (sheet 5 of 7): Information flow for call waiting

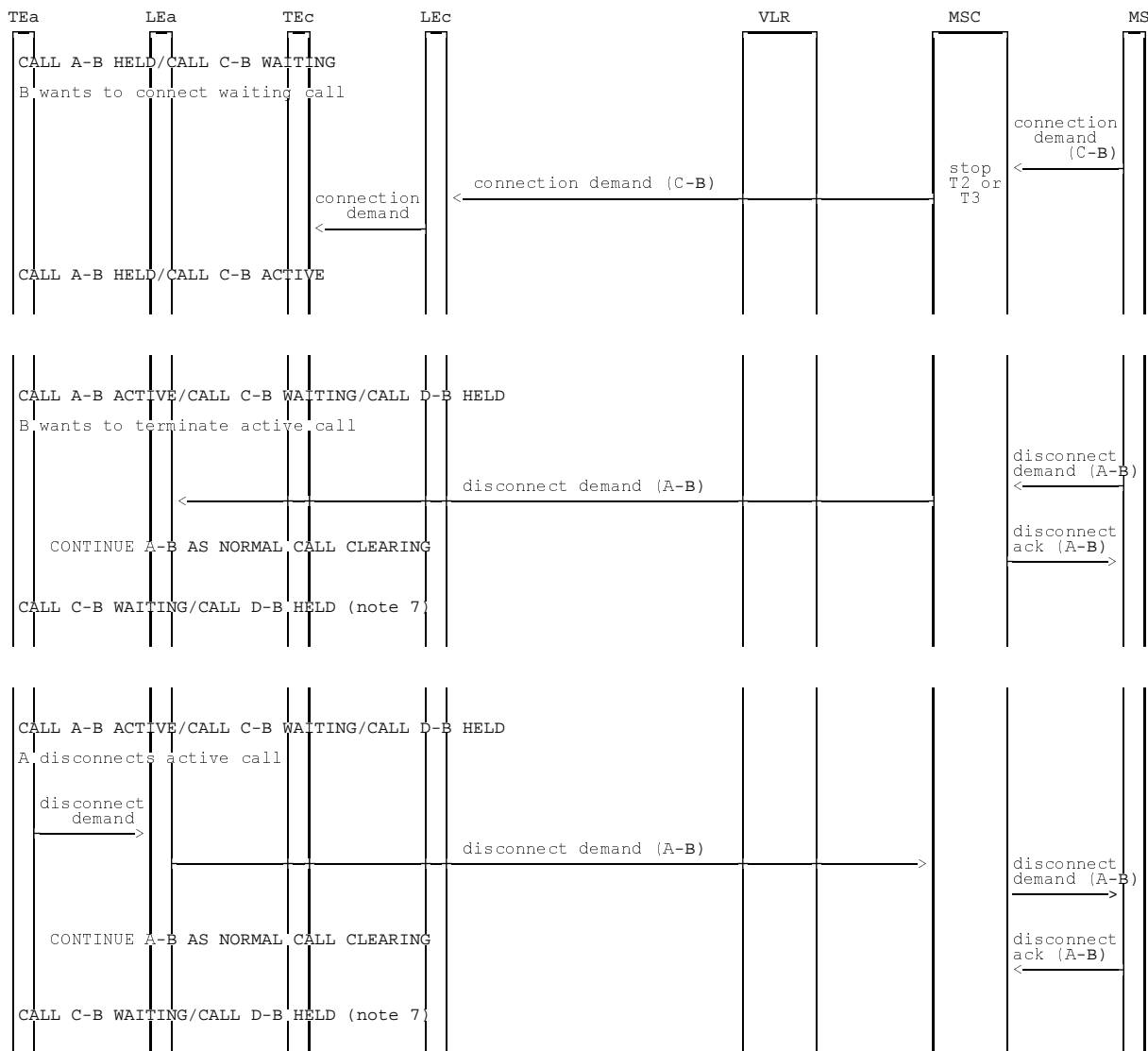

NOTE 7: This state can be treated as CALL C-B WAITING / CALL A-B HELD.

Figure 1.6 (sheet 6 of 7): Information flow for call waiting

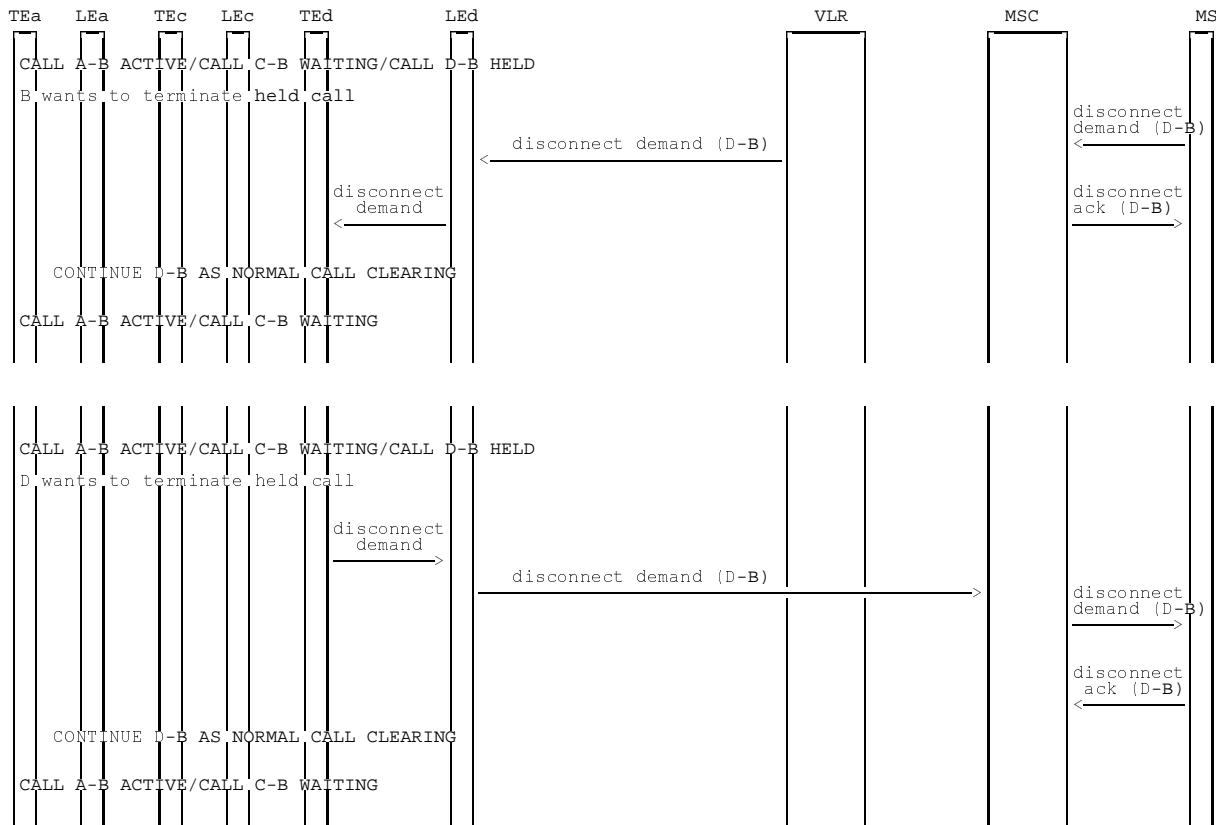

Figure 1.6 (sheet 7 of 7): Information flow for call waiting

1.3 Information stored in the HLR

Call waiting may have the following logical states (refer to TS 23.011 for an explanation of the notation):

Provisioning State	Registration State	Activation State	HLR Induction State
(Not Provisioned,	Not Applicable,	Not Active,	Not Induced)
(Provisioned,	Not Applicable,	Not Active,	Not Induced)
(Provisioned,	Not Applicable,	Active and Operative,	Not Induced)

The activation state may be different for each applicable elementary basic service group.

The provisioning state shall be on a per subscriber basis, and hence the same for all basic service groups.

The HLR shall store the logical state of the call waiting service (which shall be one of the valid states listed above) on a per elementary basic service group.

1.4 State transition model

The following figure shows the successful cases of transition between the applicable logical states of call waiting. The state changes are either caused by actions of the service provider or the mobile user.

Note that error cases are not shown in the diagram as they normally do not cause a state change. Additionally, some successful requests may not cause a state change. Hence they are not shown in the diagram.

The diagram only shows operations on elementary basic service groups.

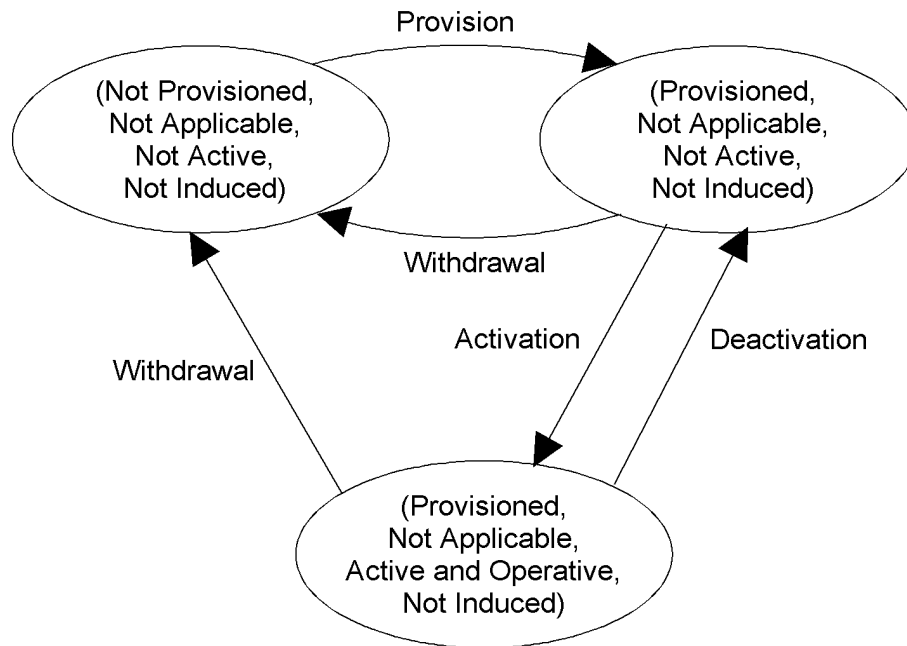

Figure 1.7: State transition model for call waiting

1.5 Transfer of information from HLR to VLR

If the provisioning state for call waiting is "Provisioned" then, when the subscriber registers on a VLR, the HLR shall send that VLR information about the logical state of call waiting.

If the logical state of call waiting is changed while a subscriber is registered on a VLR, then the HLR shall inform the VLR of the new logical state of call waiting.

1.6 Information stored in the VLR

For call waiting, the VLR shall store the service state information received from the HLR.

1.7 Handover

Handover will have no impact on the control procedures and the operation of the service.

2 Call hold (HOLD)

2.1 Functions and information flows

The following Mobile Additional Function has been identified for the call hold service:

MAF024

Call hold related authorizations examination

The ability of a PLMN component to determine the authorizations relating to call hold. See figure 2.1.

Location: VLR

The overall SDL-diagram of call hold is shown in figure 2.2.

The information flows are shown in figure 2.3. In these flows it is assumed that the served user is a mobile user and that other users are fixed network users.

Description of overall SDL-diagram for call hold

In the SDL-diagrams the states are dimensioned in two dimensions. The first dimension is a normal basic call state e.g. null or active. The second dimension is an auxiliary state associated with hold.

Three auxiliary states are used:

- i) idle;
- ii) hold request (abbreviated hold req);
 - a request has been made for the hold function
- iii) call held (abbreviated held);
 - the call is held.

Several two-dimensional states in connection with hold are possible e.g. (active, idle), (active, held) or (null, idle).

When the served user wants to shuttle between an (active, idle) call and an (active, held) call, this is achieved by a hold request for the first call immediately followed by a retrieve request for the second. To avoid having two calls on hold at the same time, the reception of the retrieve request is supervised by a timer T (T = 5 s).

The network may receive hold and retrieve requests not included in this overall SDL. These requests will be rejected by the network. For handling requests other than hold and retrieve requests look at descriptions of the other GSM supplementary services.

Process MAF024

383_21(1)

Figure 2.1

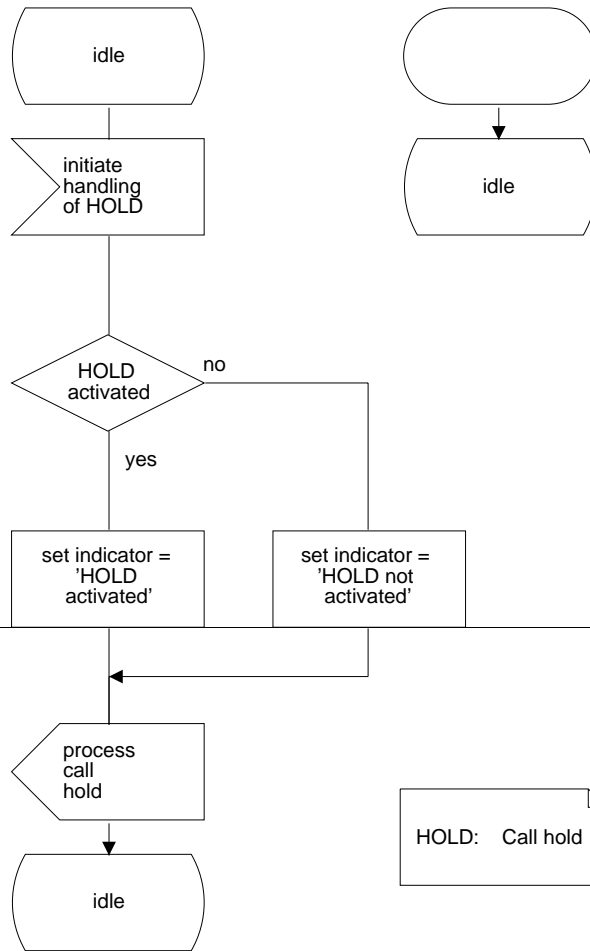

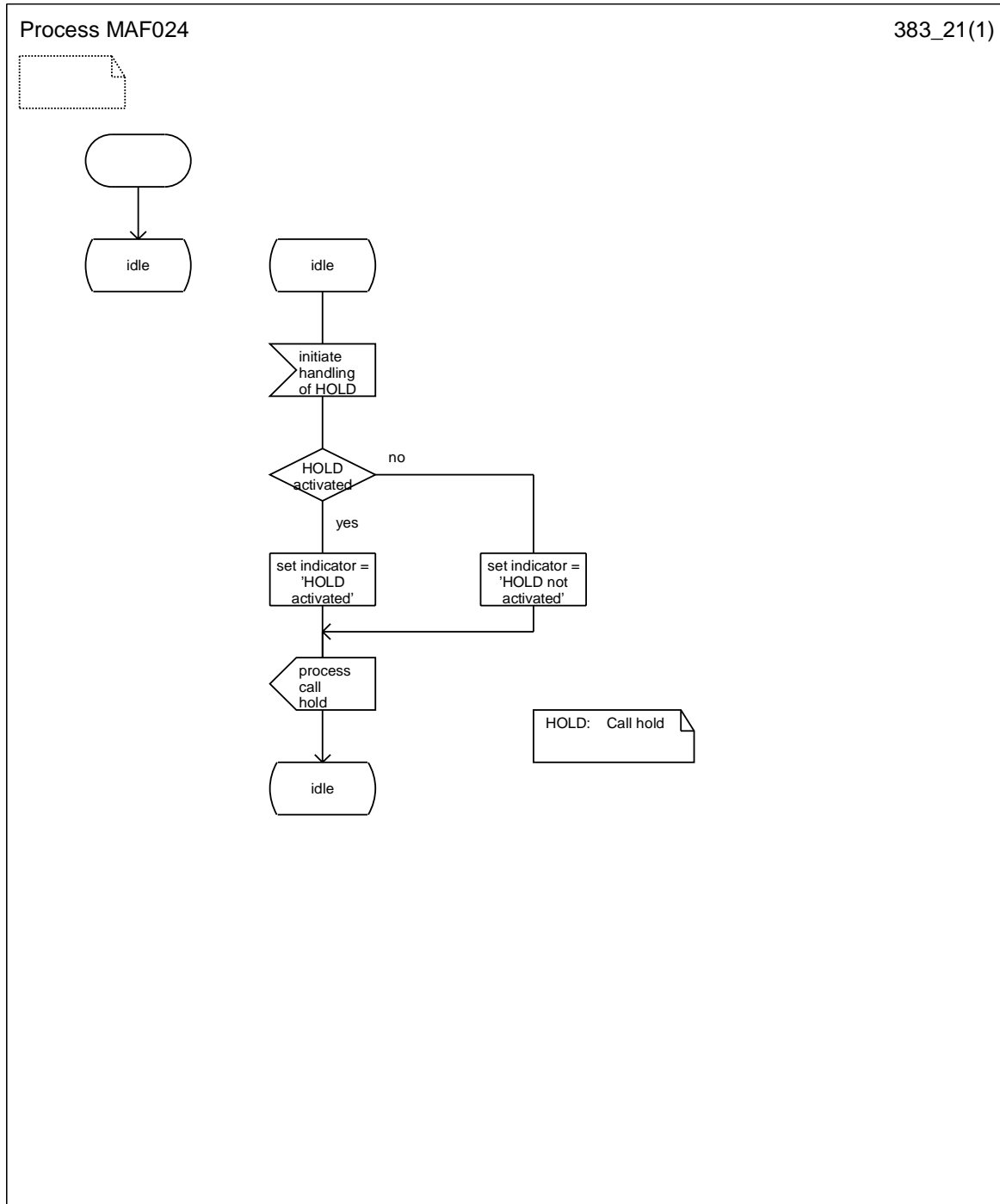
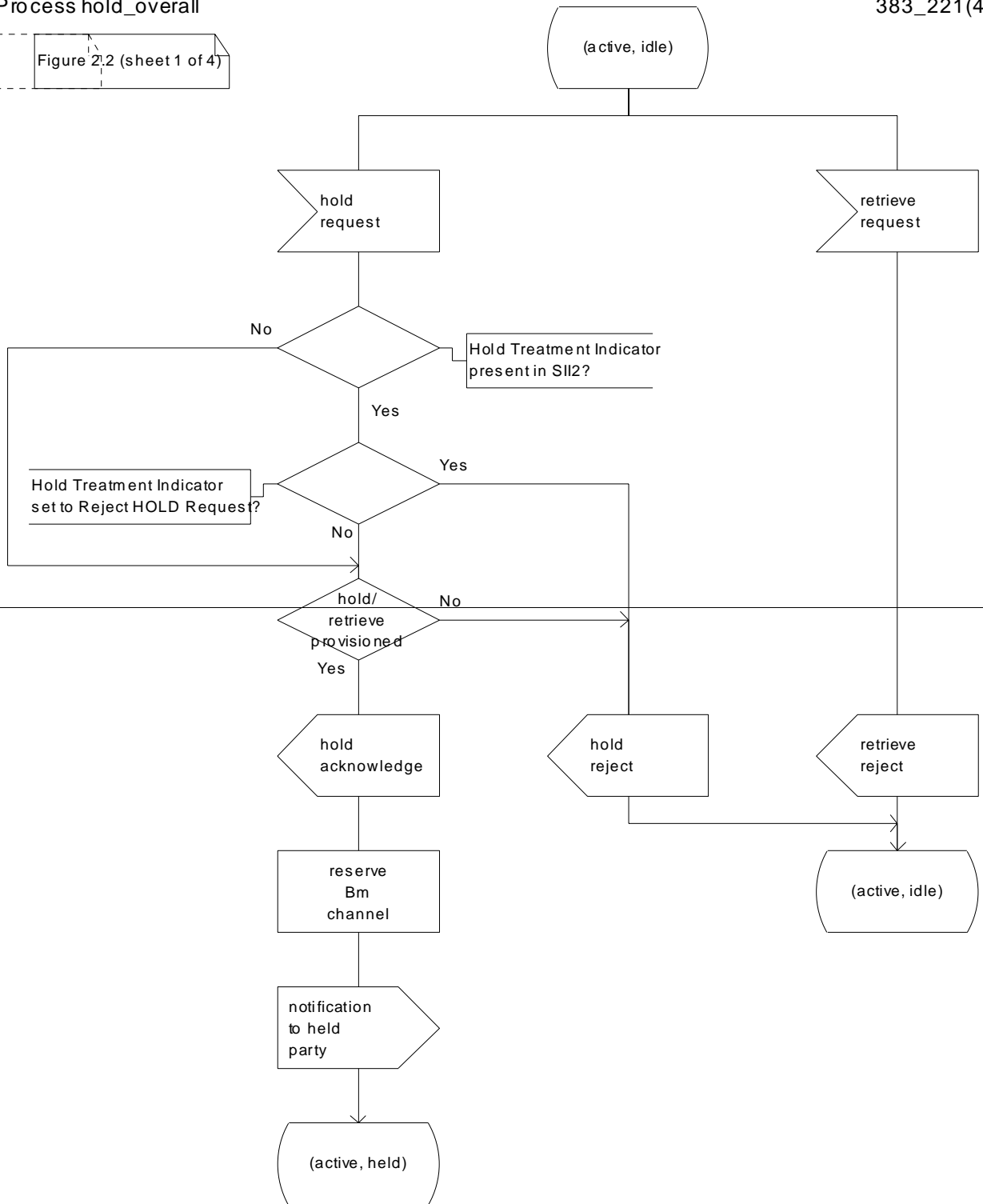

Figure 2.1: MAF024 Call hold related authorisations examination (VLR)

Process hold_overall

383_221(4)

Figure 2.2 (sheet 1 of 4)



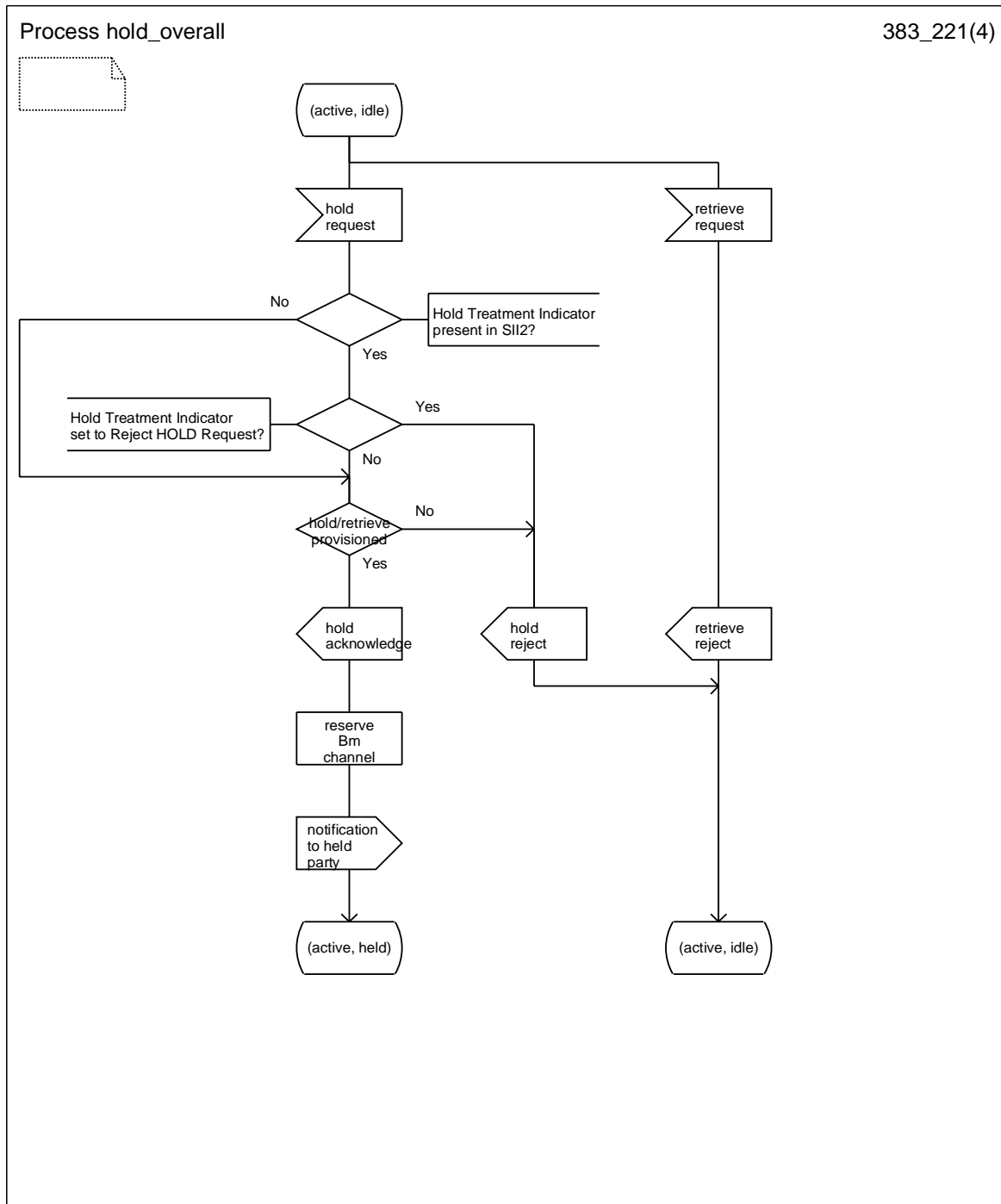
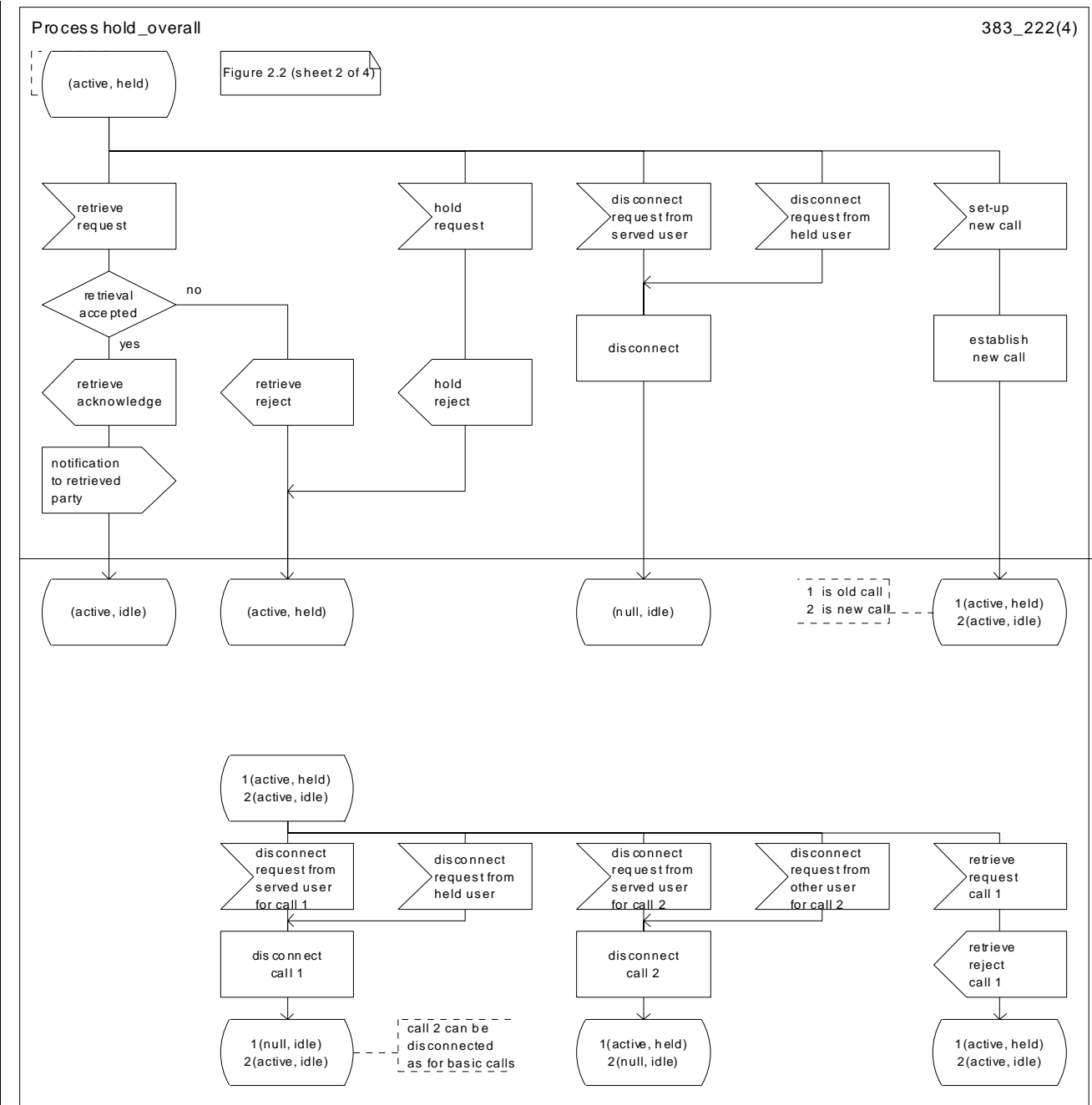

Figure 2.2 (sheet 1 of 4): Overall SDL diagram of call hold



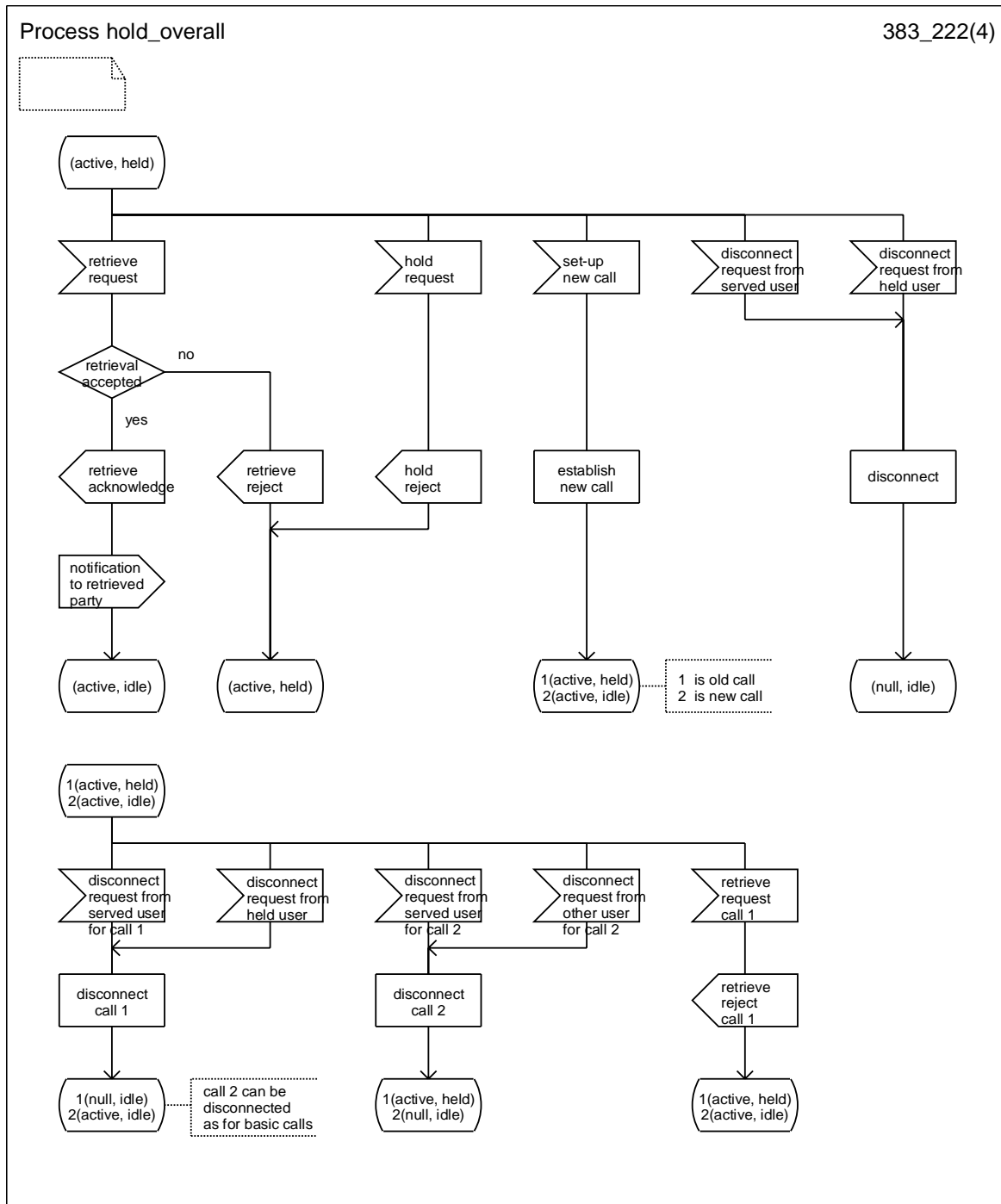
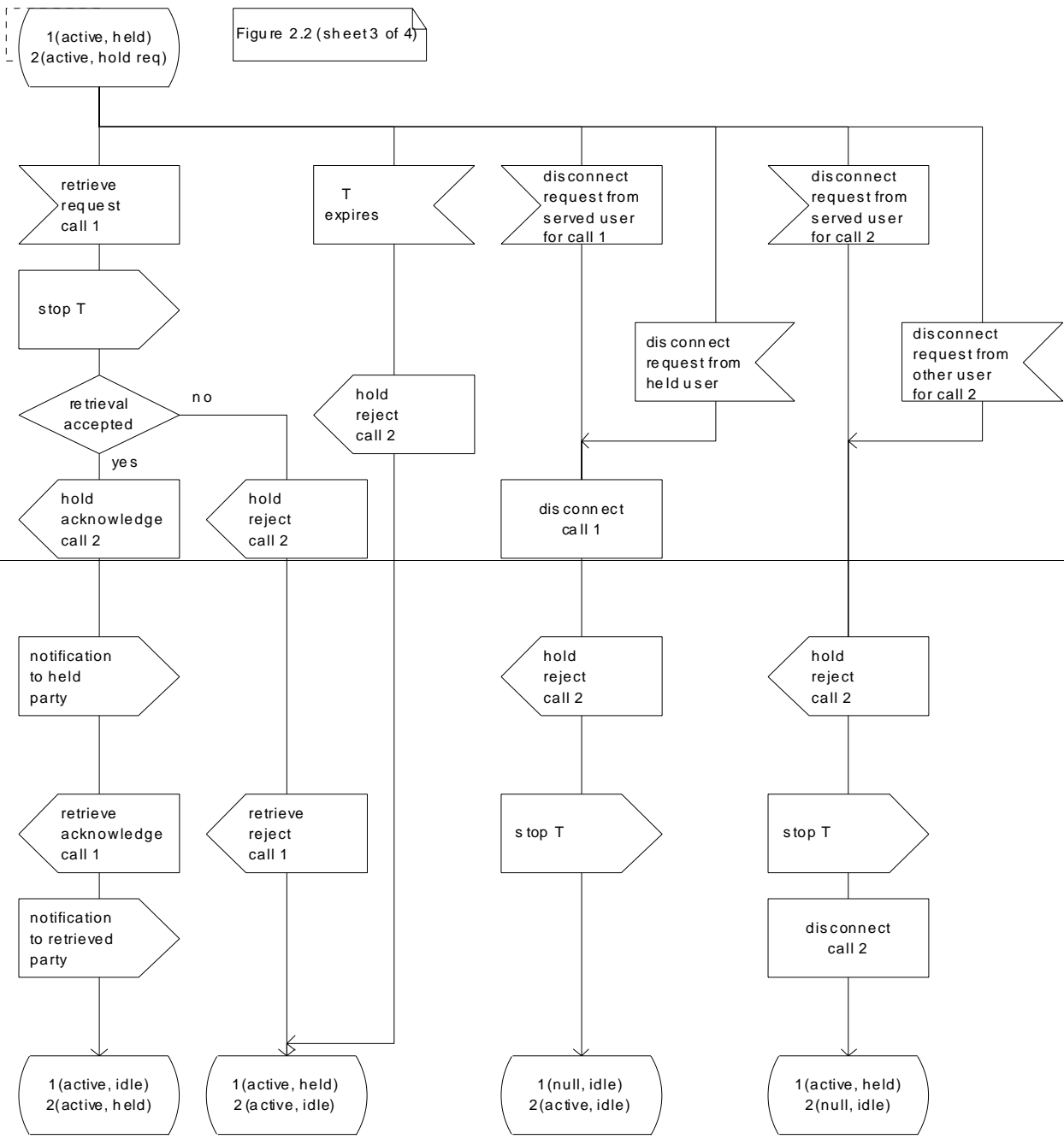

Figure 2.2 (sheet 2 of 4): Overall SDL diagram of call hold

Process hold_overall

383_223(4)

Figure 2.2 (sheet 3 of 4)



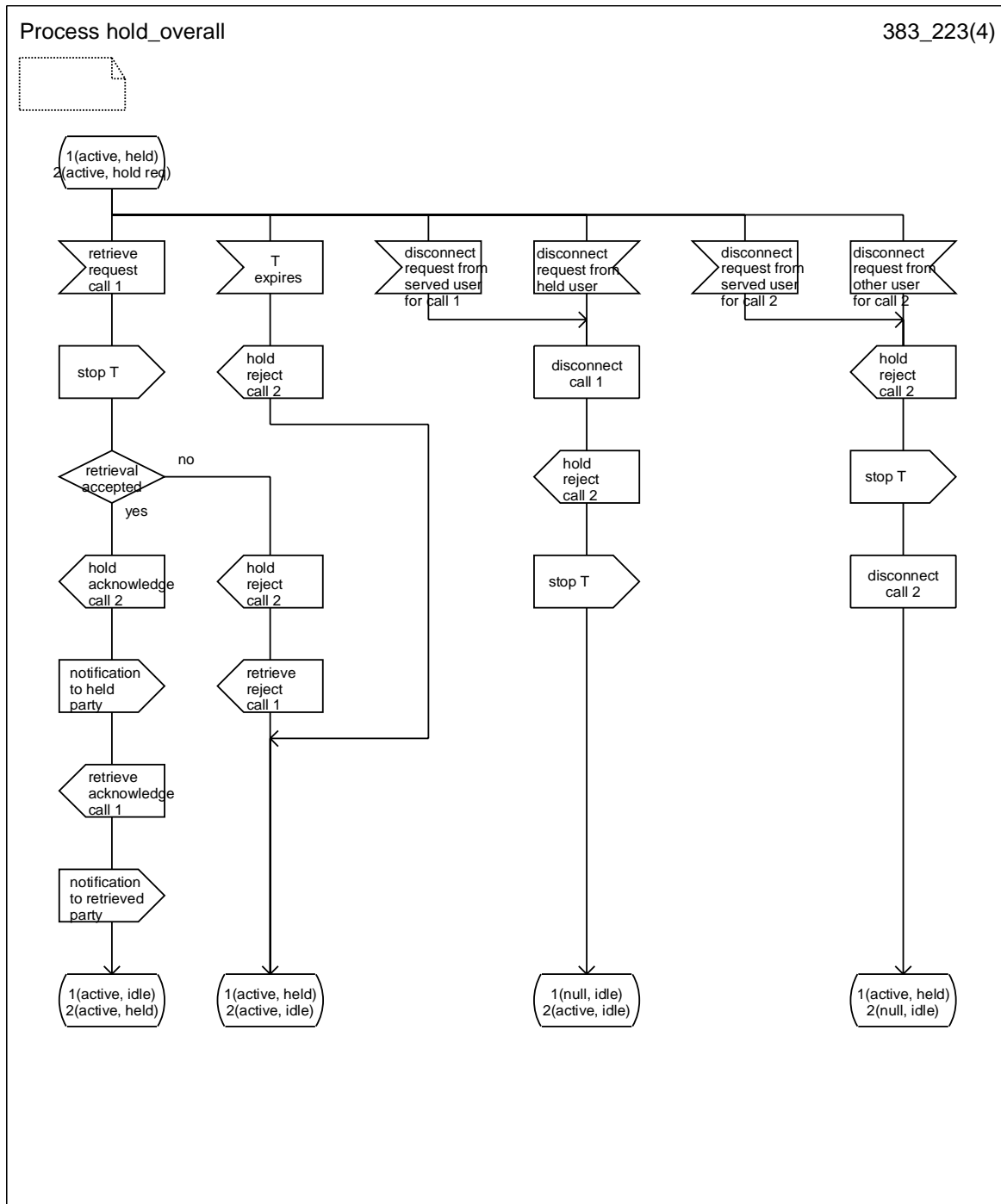
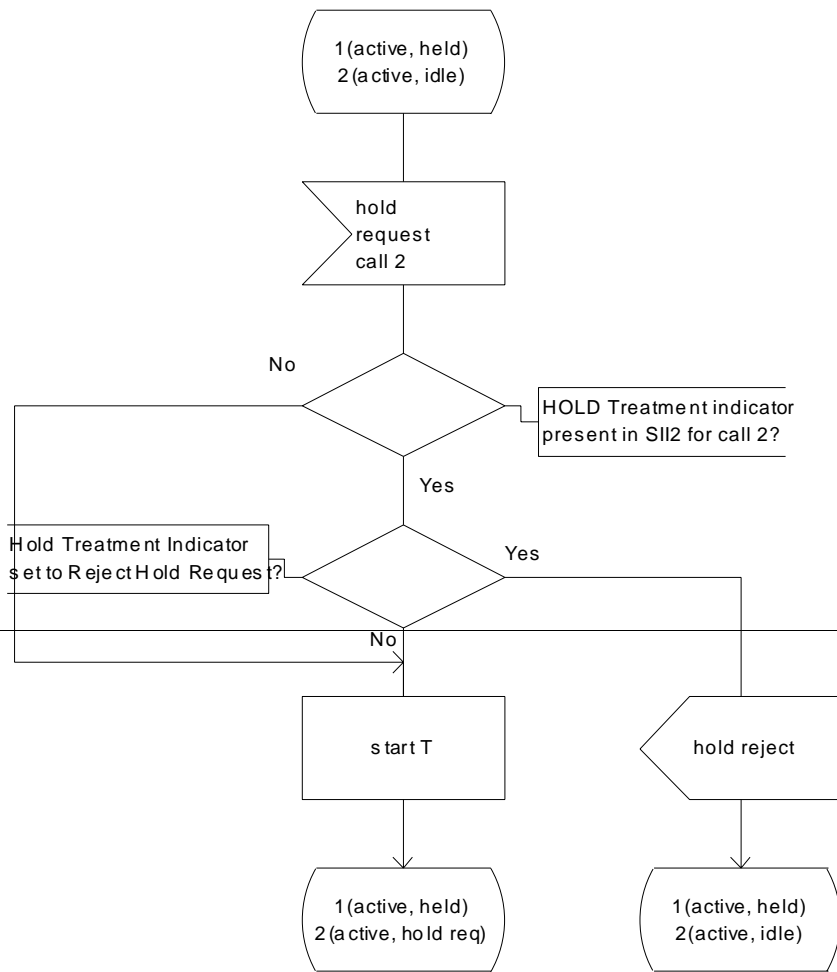

Figure 2.2 (sheet 3 of 4): Overall SDL diagram of call hold

Process hold_overall

383_224(4)

Figure 2.2
Sheet 4 of 4



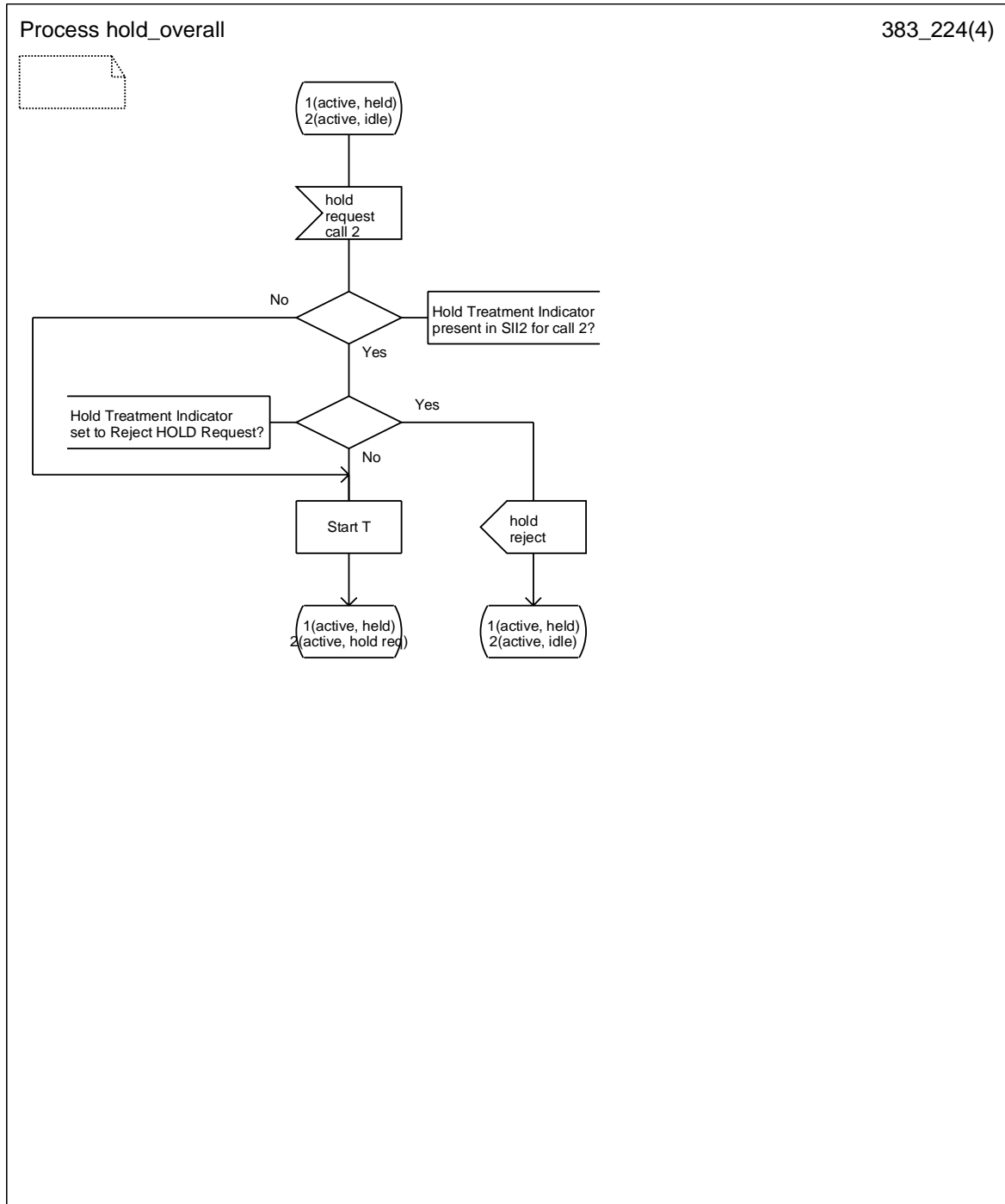

Figure 2.2 (sheet 4 of 4): Overall SDL diagram of call hold

CHANGE REQUEST		Please see embedded help file at the bottom of this page for instructions on how to fill in this form correctly.	
23.084 CR 002		Current Version: 3.1.0	
GSM (AA.BB) or 3G (AA.BBB) specification number ↑		↑ CR number as allocated by MCC support team	
For submission to: CN#09	for approval <input checked="" type="checkbox"/>	strategic <input type="checkbox"/>	(for SMG use only)
<i>list expected approval meeting # here ↑</i>	for information <input type="checkbox"/>	non-strategic <input checked="" type="checkbox"/>	

Form: CR cover sheet, version 2 for 3GPP and SMG The latest version of this form is available from: <ftp://ftp.3gpp.org/Information/CR-Form-v2.doc>

Proposed change affects: (U)SIM ME UTRAN / Radio Core Network
(at least one should be marked with an X)

Source: N4 **Date:** 2000-06-26

Subject: SDL refresh

Work item: TEI

Category:	F Correction <input type="checkbox"/> A Corresponds to a correction in an earlier release <input type="checkbox"/> B Addition of feature <input type="checkbox"/> C Functional modification of feature <input type="checkbox"/> D Editorial modification <input checked="" type="checkbox"/>	Release:	Phase 2 <input type="checkbox"/> Release 96 <input type="checkbox"/> Release 97 <input type="checkbox"/> Release 98 <input type="checkbox"/> Release 99 <input checked="" type="checkbox"/> Release 00 <input type="checkbox"/>
(only one category Shall be marked With an X)			

Reason for change: The SDL diagrams in this document have been replaced, without any semantic changes due to the following reasons:

- In the previous version, the diagrams contained nothing but garbage when viewed on-screen.
- Some of the diagrams were, if not impossible, very hard to print.
- A binary version of the SDL diagrams, suitable for standard tools, is needed to assure a qualitative handling of the diagrams in the future. Telelogic Tau SDL Suite (formerly known as SDT) versions of the diagrams have been created and made available, providing a new fresh base for future changes. For obvious reasons, the binary version, to be regarded as the source, should be mirrored in the document. Therefore, the diagrams replacing the previous versions are printouts of the binary versions.

Clauses affected: All figures in the document, containing an SDL diagram.

Other specs Affected:	Other 3G core specifications <input type="checkbox"/> Other GSM core specifications <input type="checkbox"/> MS test specifications <input type="checkbox"/> BSS test specifications <input type="checkbox"/> O&M specifications <input type="checkbox"/>	→ List of CRs: → List of CRs: → List of CRs: → List of CRs: → List of CRs:	
------------------------------	---	--	--

Other comments: ETSI plans to make the binary versions of the SDL diagrams available on the 3GPP website.

Functions and information flows

The following Mobile Additional Function has been identified for Multi Party service:

MAF026

Multi Party service related authorizations examination

The ability of a PLMN component to determine the authorizations relating to Multi Party service. See figure 2.1.

Location: VLR

The overall SDL-diagram of Multi Party service is shown in figure 1.2.

This overall SDL-diagram represents the network as a whole. The overall SDL-diagram shows the status of the service as perceived by the served mobile subscriber, as well as the status as perceived by any of the other parties. Beside this, the overall SDL-diagram shows the actions to be taken by the network and the information provided by the network to the users.

Within the authorization examinations diagram, the messages shown to and from the left are to and from the VLR.

Within the overall SDL diagram, messages to and from the served mobile subscriber are indicated to and from the left, whereas messages to and from remote parties are indicated to and from the right.

The information flow for Multi Party service is shown in figure 1.3.

In the information flow it is assumed that the served subscriber is a mobile subscriber and that the other parties are all fixed ISDN subscribers. For the purposes of the information flow diagrams it is assumed that there are only two remote parties. Where there are more than two remote parties, signals to any party connected to the MPTY bridge shall apply to all other parties connected to the MPTY bridge, except where a single remote party is to be selected for a private communication.

As a consequence of this assumption, after the MPTY is split (to establish a private communication) it only contains one remote party. However, the end state for disconnection of or by that remaining remote party is shown as A-B ACTIVE / MPTY HELD. This is to indicate that the disconnection by a single remote party will not necessarily cause the MPTY call to be released. This will only happen when that remote party is the only remaining party in the MPTY call.

Party A is the subscriber controlling the MPTY call (serviced mobile subscriber). Party B is the first remote party called. Party C is the second remote party called.

Remote parties are disconnected by the generic disconnect/release procedure. Any scenario requiring disconnection of remote parties shown in the SDL diagrams but not explicitly shown in the flow diagrams shall follow the procedure shown in the flow diagrams for similar scenarios.

Functions to be performed by the fixed ISDN (for example hold authorizations examination) are not shown in the information flow; only the functions to be performed by the PLMN are shown.

It is assumed that the Multi Party bridge is located in the MSC.

In the SDL-diagrams a two dimensional state in conjunction with call hold is used: (active,hold request).

- The first dimension is a normal basic call state "active".
- The second dimension is "hold request" (abbreviated hold req) meaning that a request has been made for the hold function.

To avoid having two calls on hold at the same time the reception of the retrieve request is supervised by timer T as defined in TS 23.083.

Note that while the Multi Party is on hold, the remote parties can continue to communicate with each other.

Process MPTY_MAF026

384_11(1)

Figure 1.1

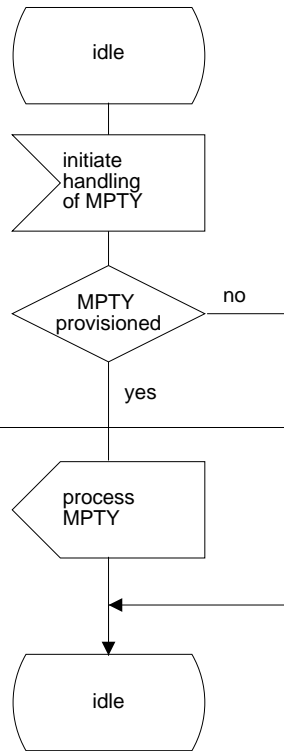

MPTY: Multi Party service.

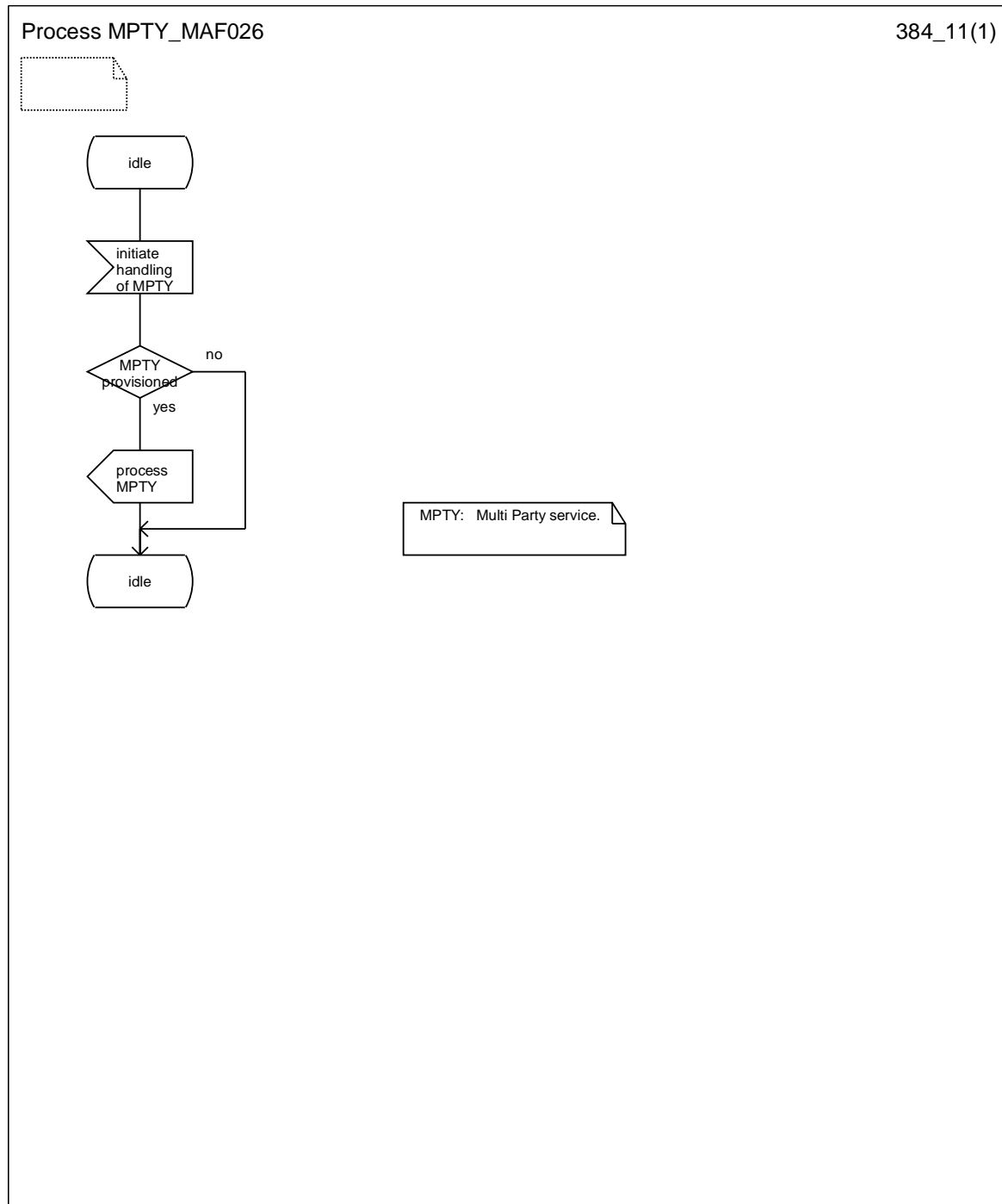
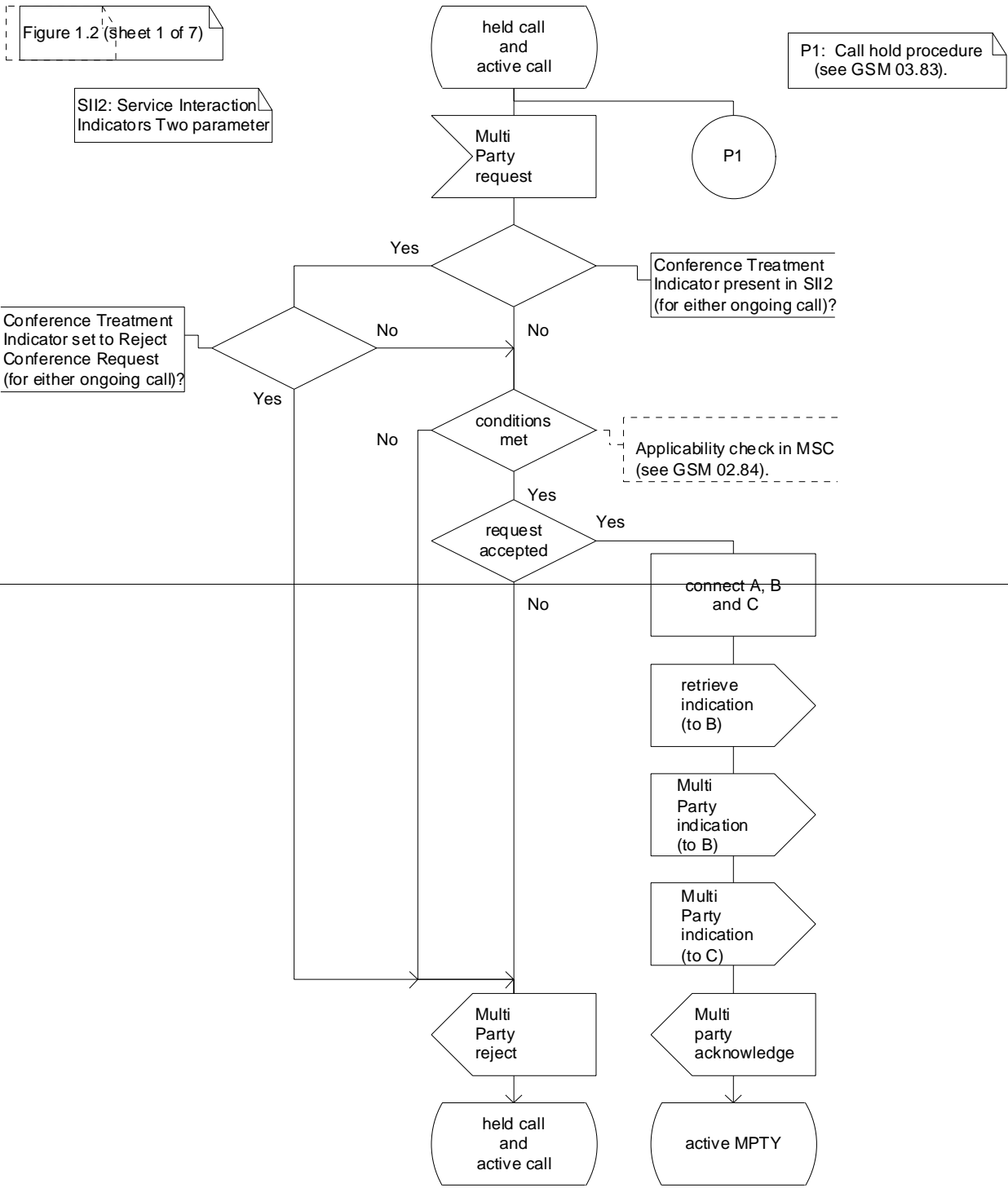

Figure 1.1: MAF026 Multi Party service related authorisations examination (VLR)

Process MPTY_overall

384_121(7)



Process MPTY_overall

384_122(7)

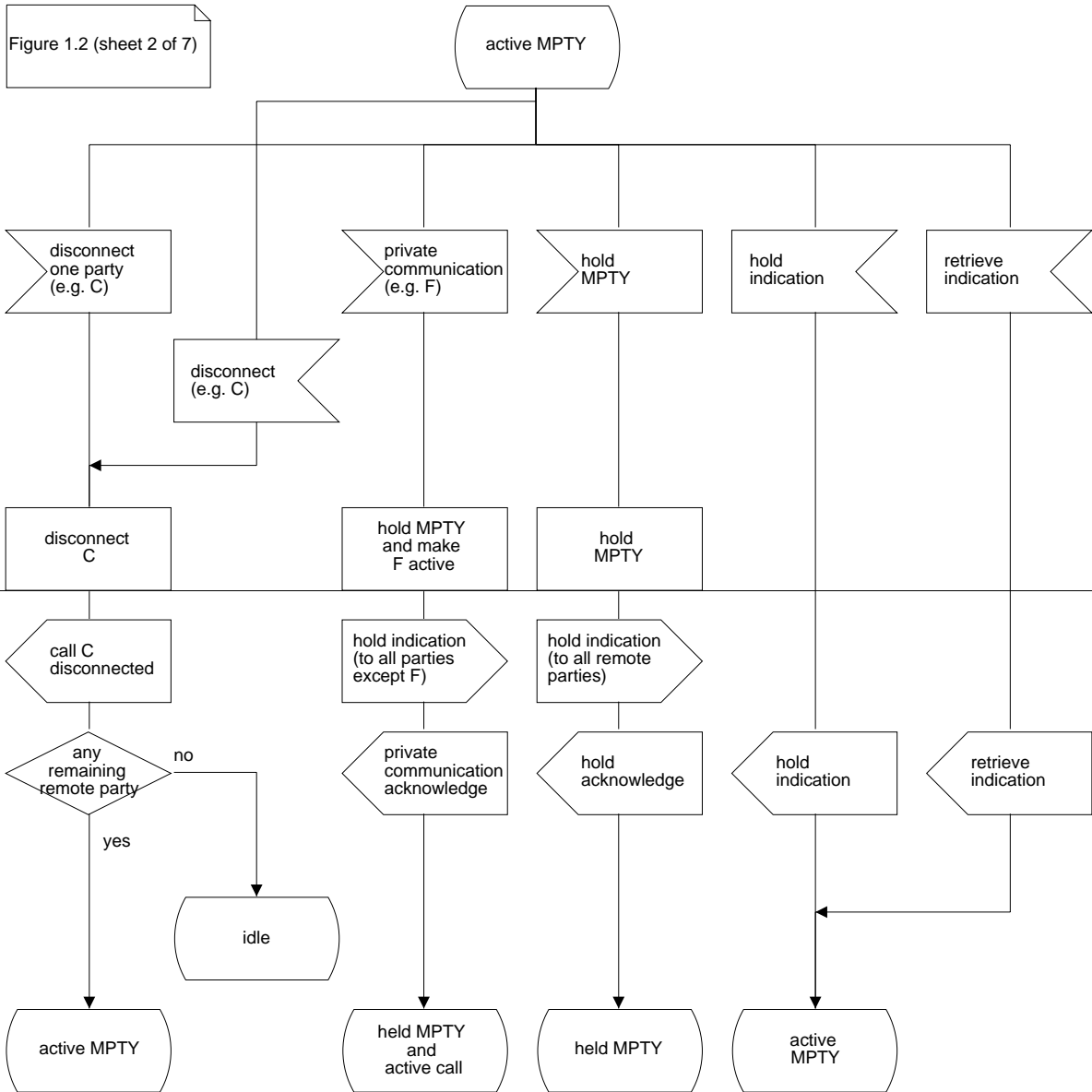

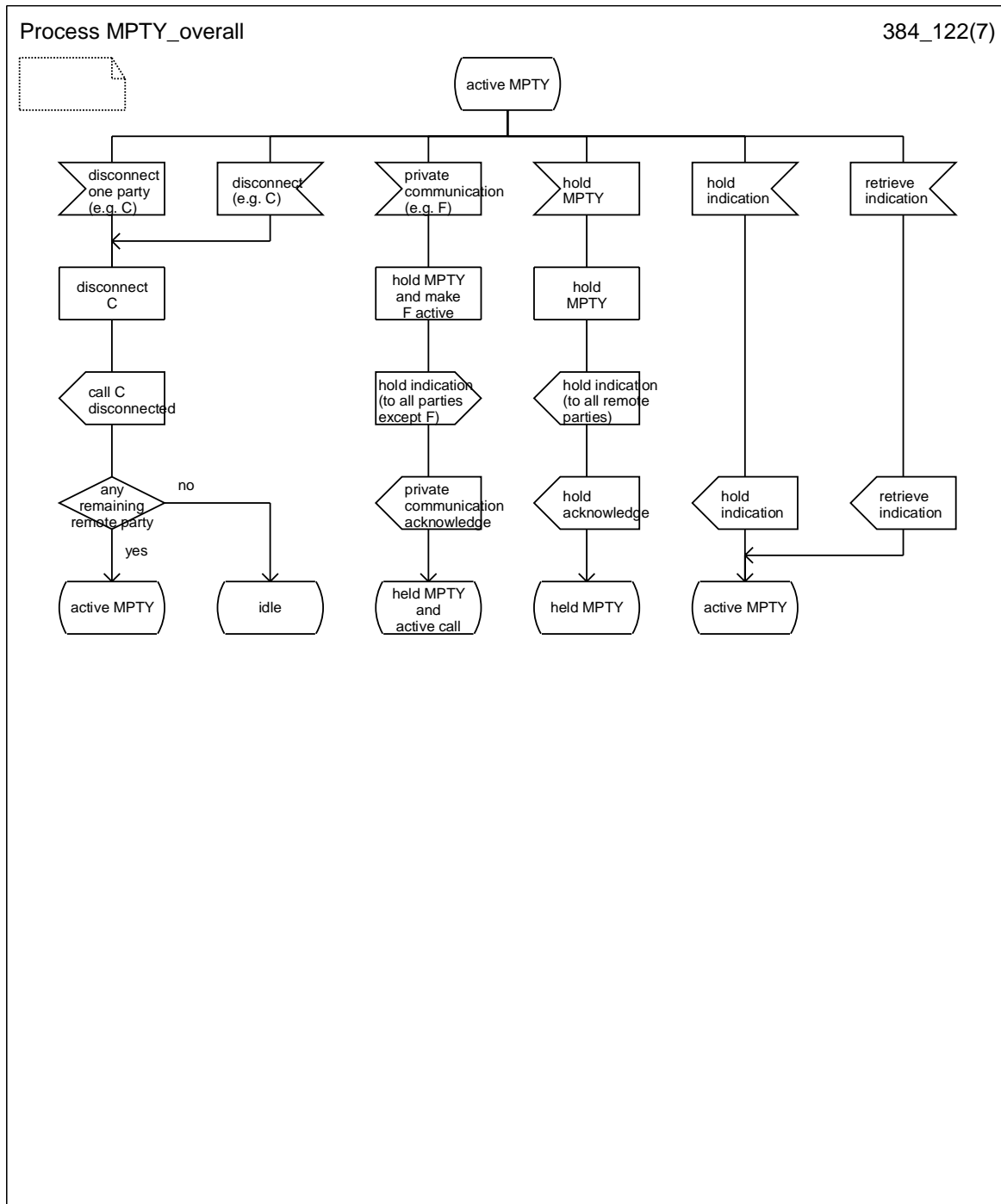
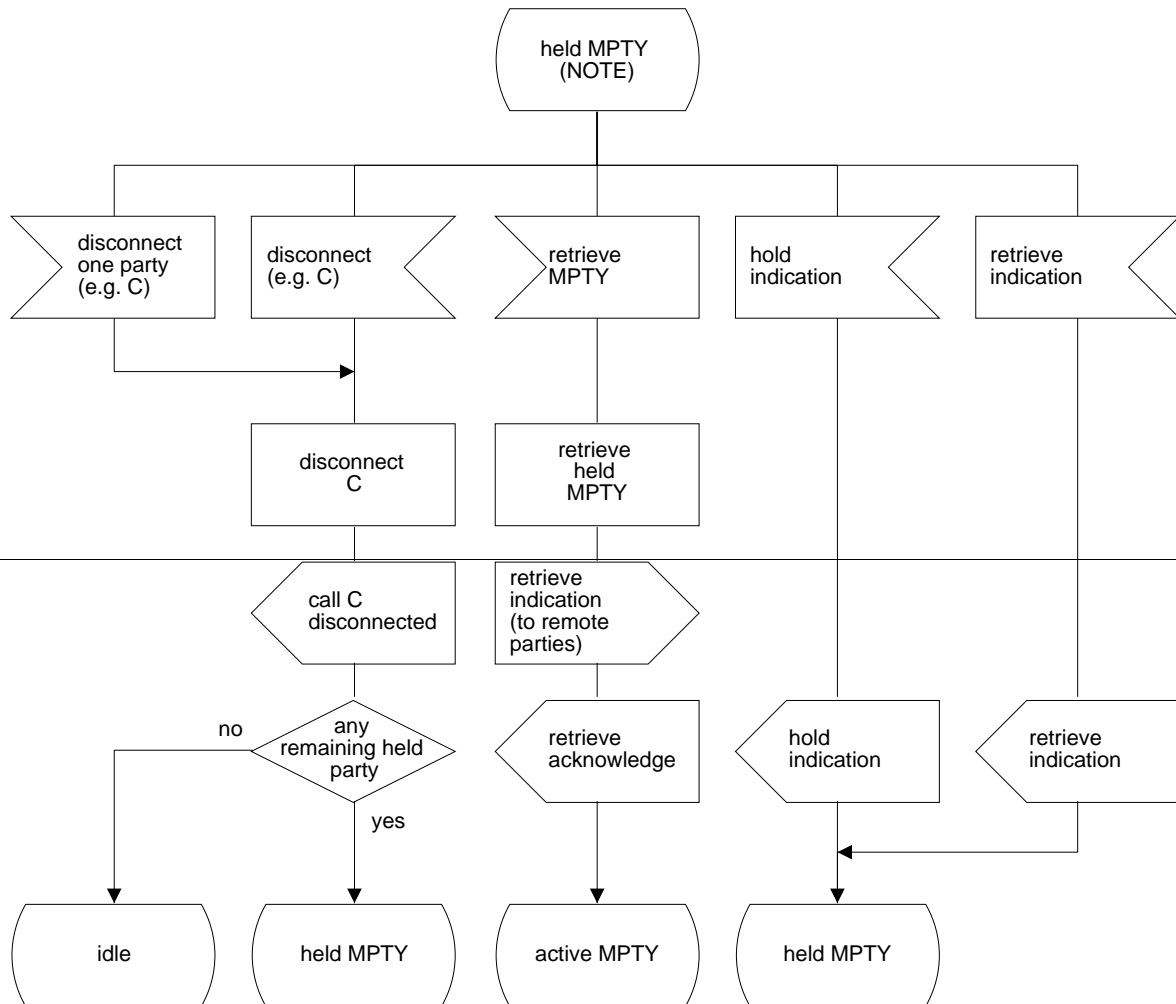

Figure 1.2 (sheet 2 of 7): Overall SDL diagram of Multi Party service

Process MPTY_overall

384_123(7)

Figure 1.2 (sheet 3 of 7)



NOTE: It is also possible to initiate a new call or process a call waiting request from this state (see GSM 03.83). In either case, this is likely to result in a 'held MPTY and active call'.

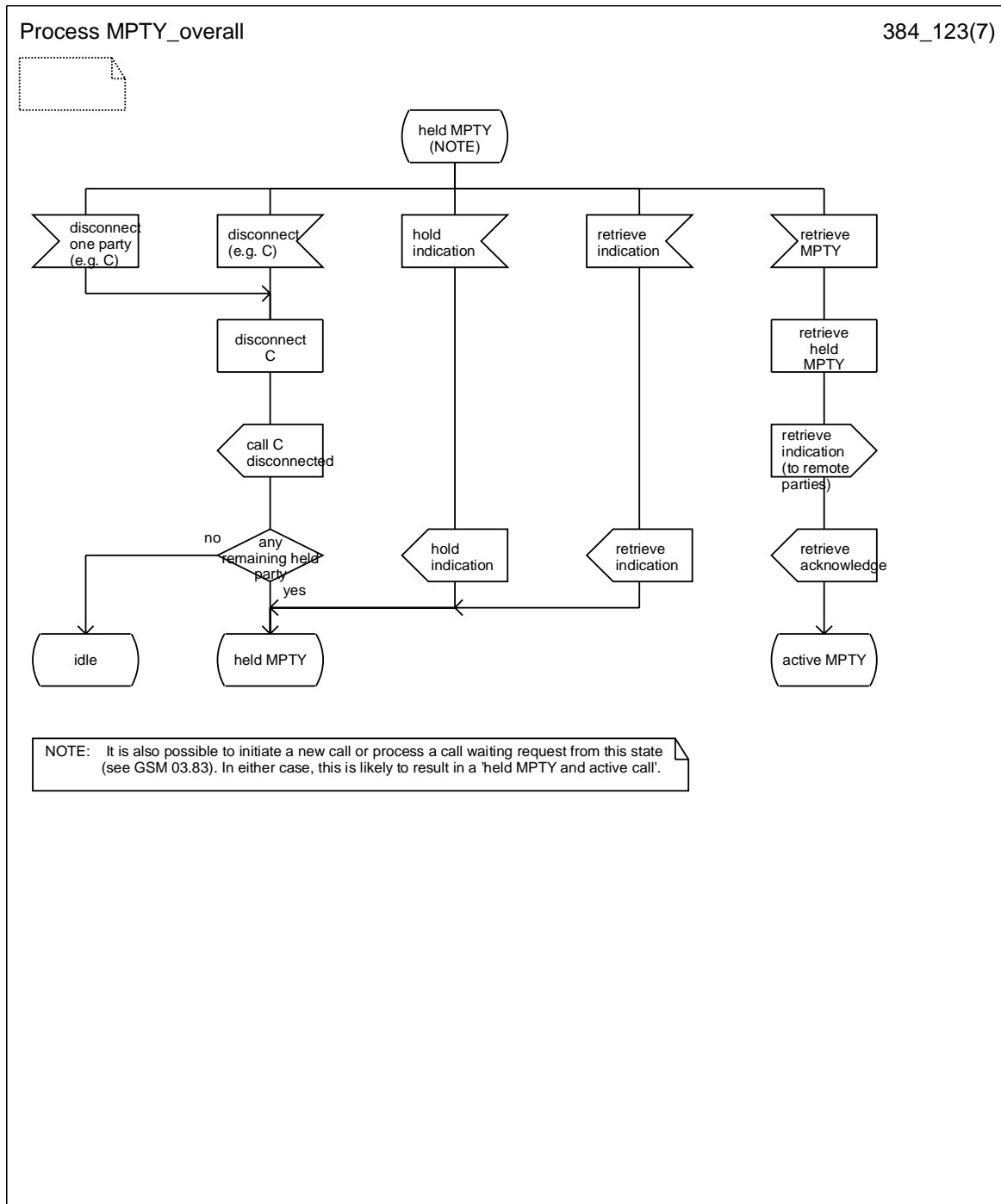
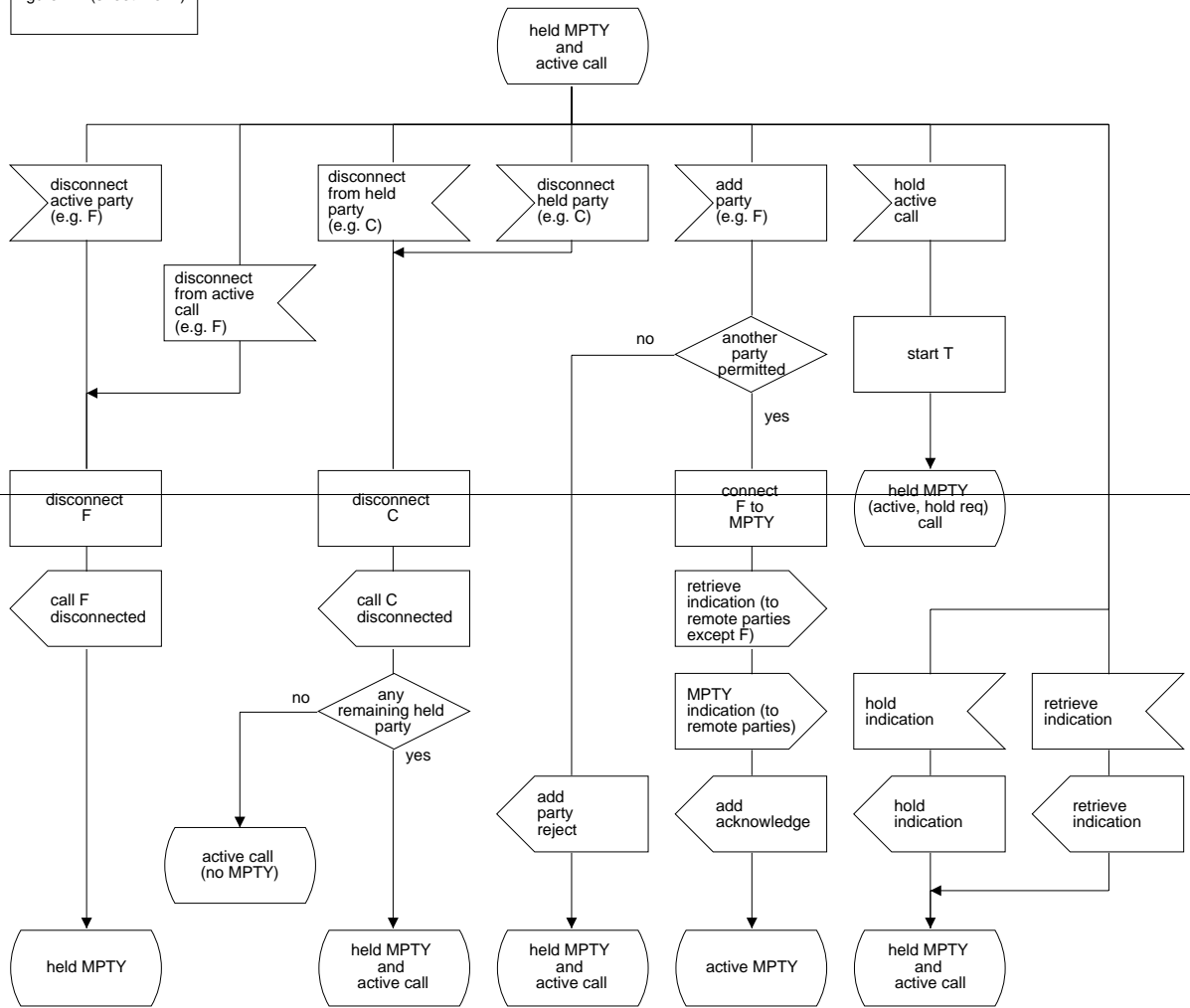

Figure 1.2 (sheet 3 of 7): Overall SDL diagram of Multi Party service

Process MPTY_overall

384_124(7)

Figure 1.2 (sheet 4 of 7)



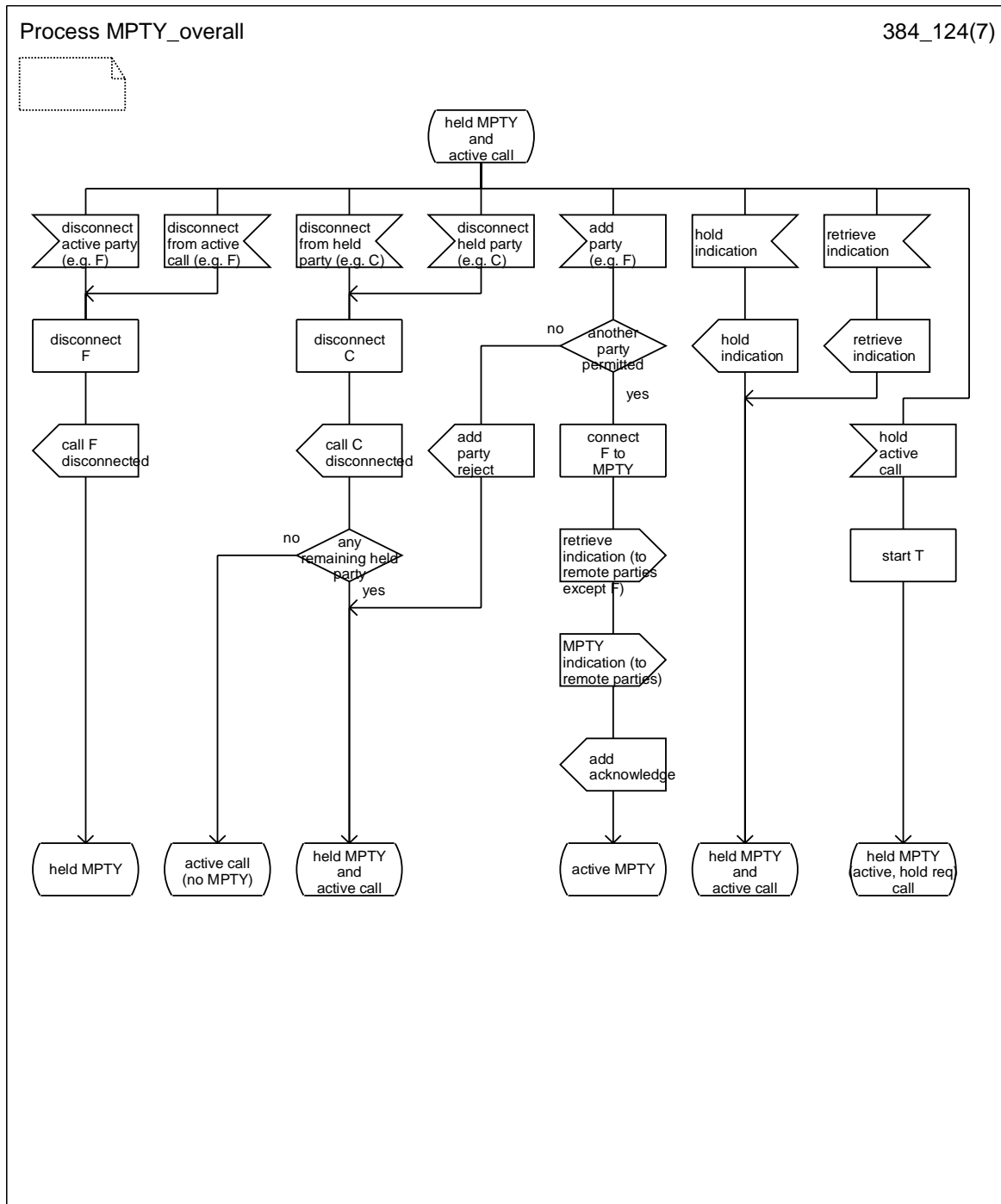
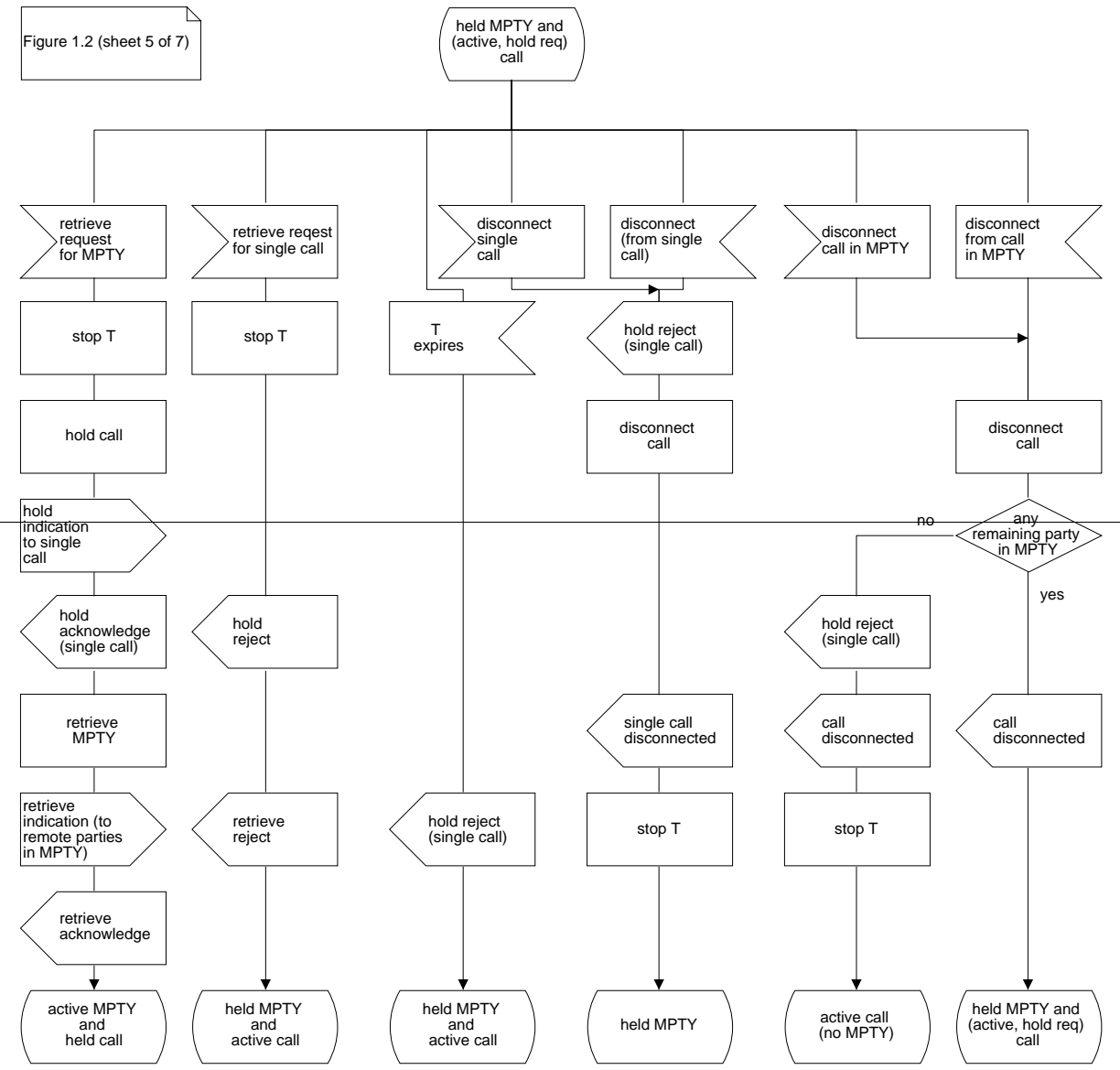

Figure 1.2 (sheet 4 of 7): Overall SDL diagram of Multi Party service

Process MPTY_overall

384_125(7)

Figure 1.2 (sheet 5 of 7)



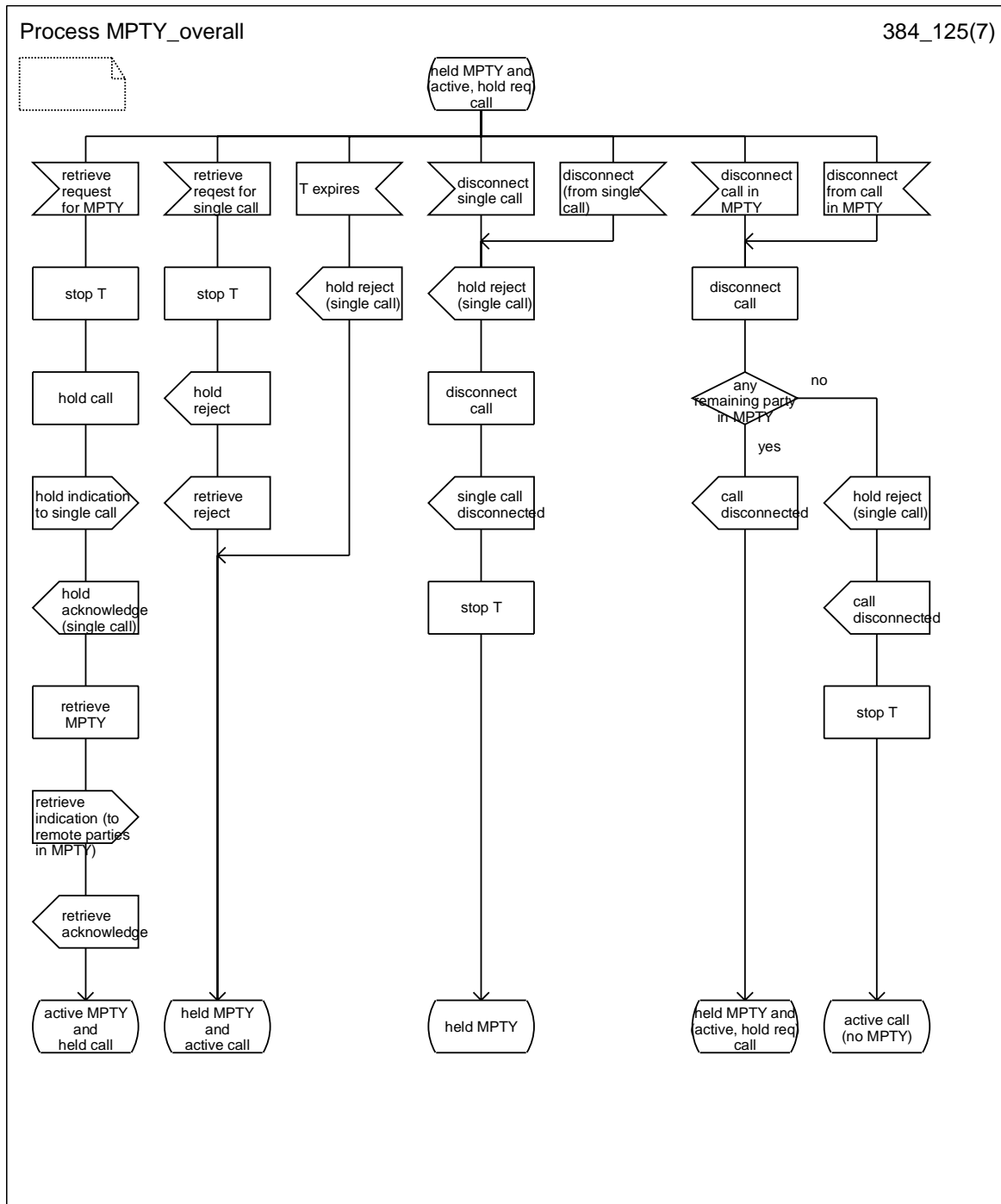
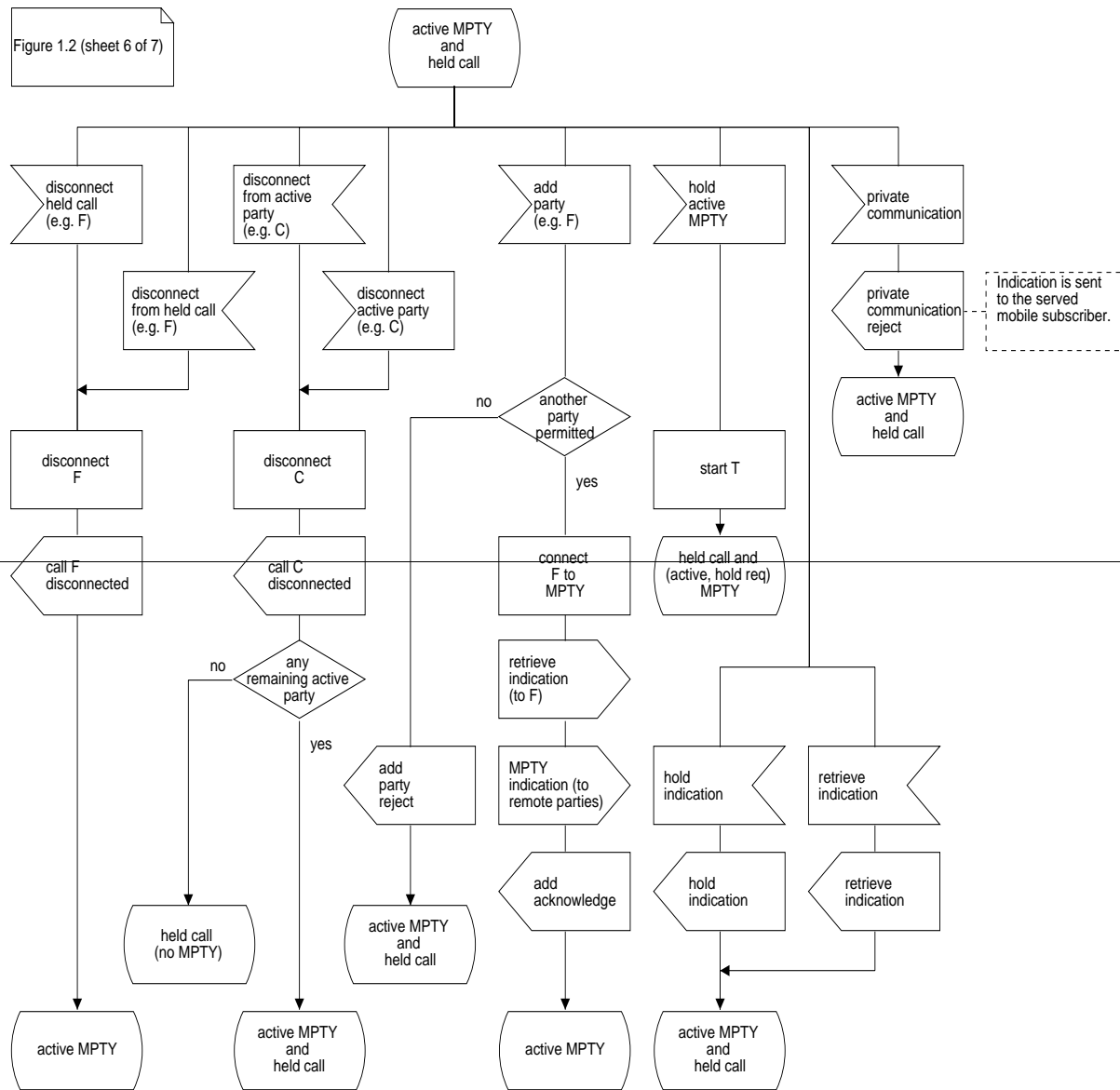

Figure 1.2 (sheet 5 of 7): Overall SDL diagram of Multi Party service

Process MPTY_overall

384_126(7)

Figure 1.2 (sheet 6 of 7)



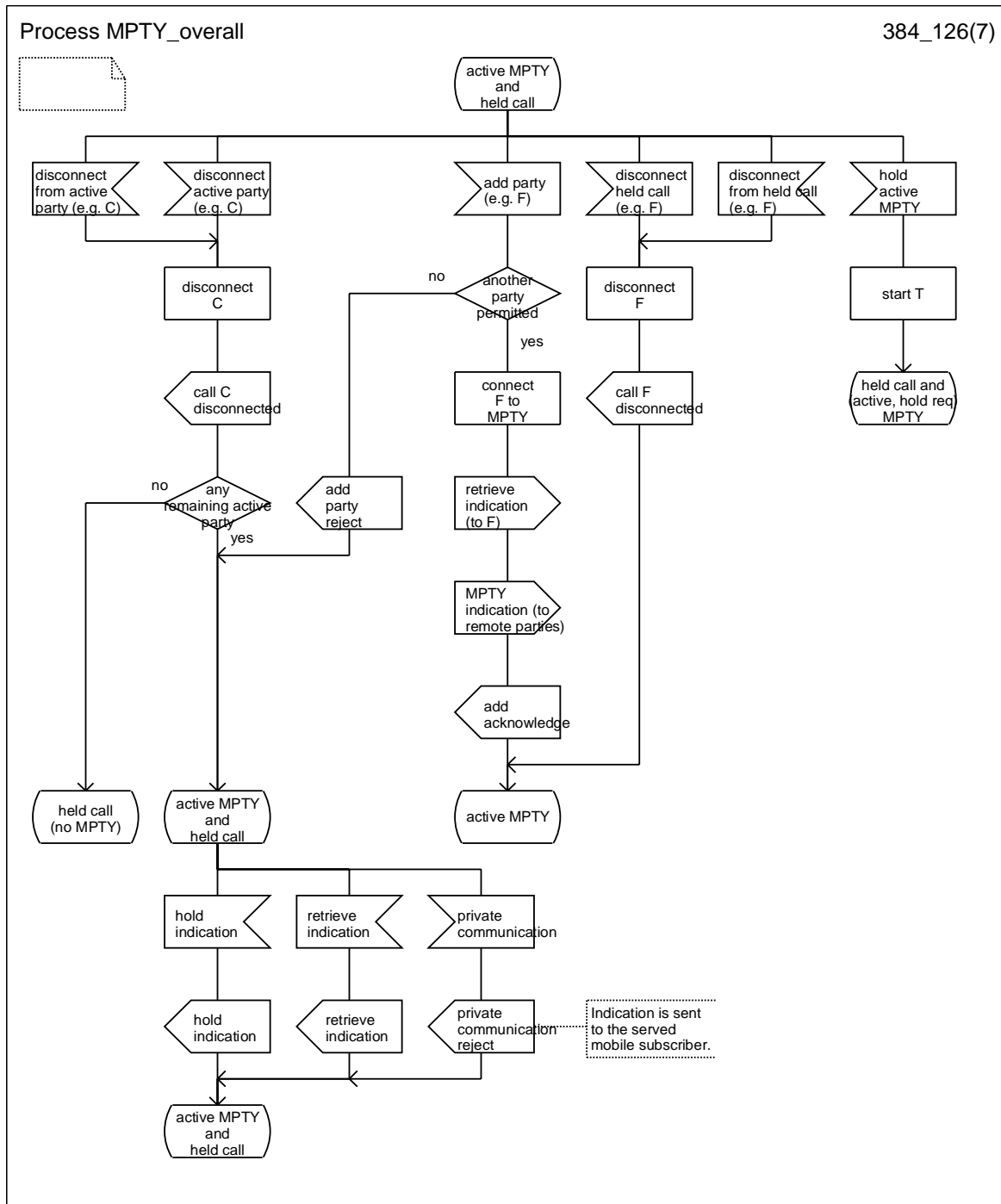
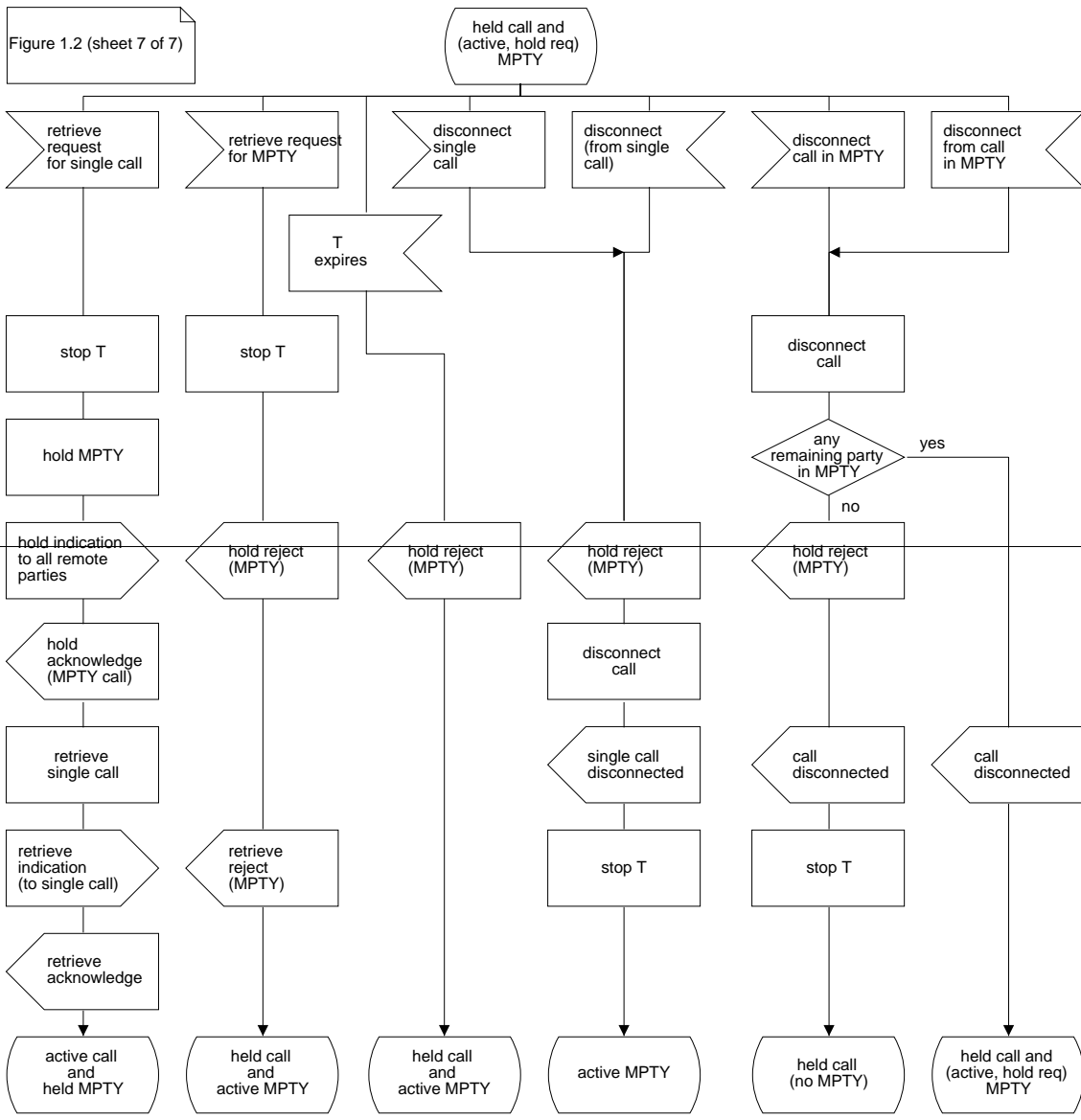

Figure 1.2 (sheet 6 of 7): Overall SDL diagram of Multi Party service

Process MPTY_overall

384_127(7)

Figure 1.2 (sheet 7 of 7)



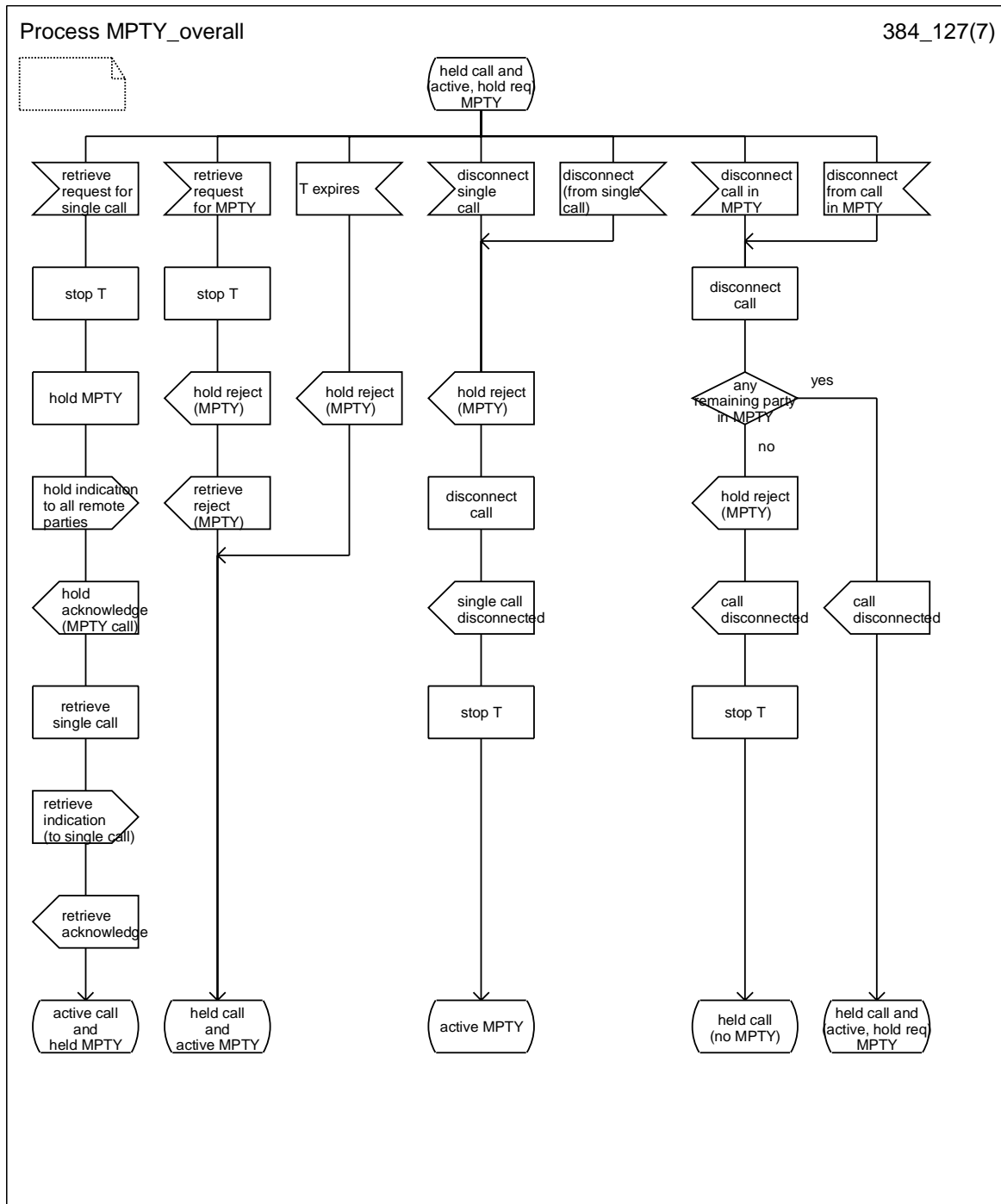

Figure 1.2 (sheet 7 of 7): Overall SDL diagram of Multi Party service

CHANGE REQUEST		Please see embedded help file at the bottom of this page for instructions on how to fill in this form correctly.	
23.085 CR 001		Current Version: 3.0.1	
GSM (AA.BB) or 3G (AA.BBB) specification number ↑		↑ CR number as allocated by MCC support team	
For submission to: CN#09	for approval <input checked="" type="checkbox"/>	strategic <input type="checkbox"/>	(for SMG use only)
list expected approval meeting # here ↑	for information <input type="checkbox"/>	non-strategic <input checked="" type="checkbox"/>	

Form: CR cover sheet, version 2 for 3GPP and SMG The latest version of this form is available from: <ftp://ftp.3gpp.org/Information/CR-Form-v2.doc>

Proposed change affects: (U)SIM ME UTRAN / Radio Core Network
 (at least one should be marked with an X)

Source: N4 **Date:** 2000-06-26

Subject: SDL refresh

Work item: TEI

Category:	F Correction <input type="checkbox"/> A Corresponds to a correction in an earlier release <input type="checkbox"/> B Addition of feature <input type="checkbox"/> C Functional modification of feature <input type="checkbox"/> D Editorial modification <input checked="" type="checkbox"/>	Release:	Phase 2 <input type="checkbox"/> Release 96 <input type="checkbox"/> Release 97 <input type="checkbox"/> Release 98 <input type="checkbox"/> Release 99 <input checked="" type="checkbox"/> Release 00 <input type="checkbox"/>
(only one category shall be marked With an X)			

Reason for change: The SDL diagrams in this document have been replaced, without any semantic changes due to the following reasons:

- In the previous version, the diagrams contained nothing but garbage when viewed on-screen.
- Some of the diagrams were, if not impossible, very hard to print.
- A binary version of the SDL diagrams, suitable for standard tools, is needed to assure a qualitative handling of the diagrams in the future. Telelogic Tau SDL Suite (formerly known as SDT) versions of the diagrams have been created and made available, providing a new fresh base for future changes. For obvious reasons, the binary version, to be regarded as the source, should be mirrored in the document. Therefore, the diagrams replacing the previous versions are printouts of the binary versions.

Clauses affected: All figures in the document, containing an SDL diagram.

Other specs Affected:	Other 3G core specifications <input type="checkbox"/> Other GSM core specifications <input type="checkbox"/> MS test specifications <input type="checkbox"/> BSS test specifications <input type="checkbox"/> O&M specifications <input type="checkbox"/>	→ List of CRs: <input type="text"/> → List of CRs: <input type="text"/> → List of CRs: <input type="text"/> → List of CRs: <input type="text"/> → List of CRs: <input type="text"/>
------------------------------	---	---

Other comments: ETSI plans to make the binary versions of the SDL diagrams available on the 3GPP website.

1.2.2 Information flows

The information flows for the CUG supplementary service are shown in figures 1.3 to 1.7.

List of figures:

- figure 1.3 Mobile Originated CUG calls;
- figure 1.4 Mobile Terminated CUG calls;
- figure 1.5 MT CUG call handling at the called party MSC/VLR;
- figure 1.6 Interworking with Non-ISDN/Non-GSM networks;
- figure 1.7 CUG interworking with Non-CUG GSM PLMN.

NOTE to figures 1.3 to 1.7:

"Conditional CUG Info" means that CUG information may or may not be present in the signalling message depending on the call case. These figures are intended to cover all call cases described in the CUG authorisation functions.

Process CUG_MAF014

385_11(1)

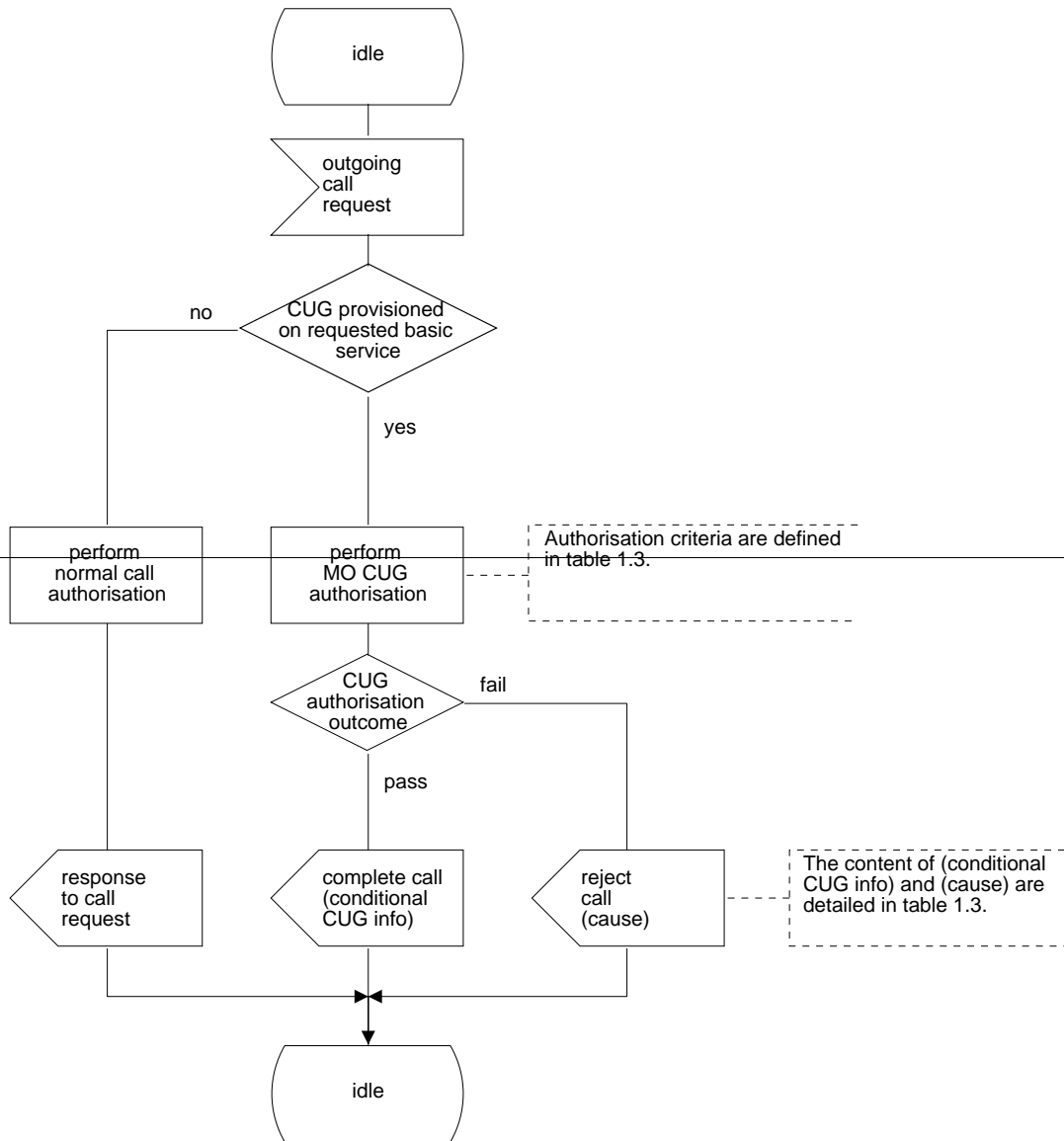

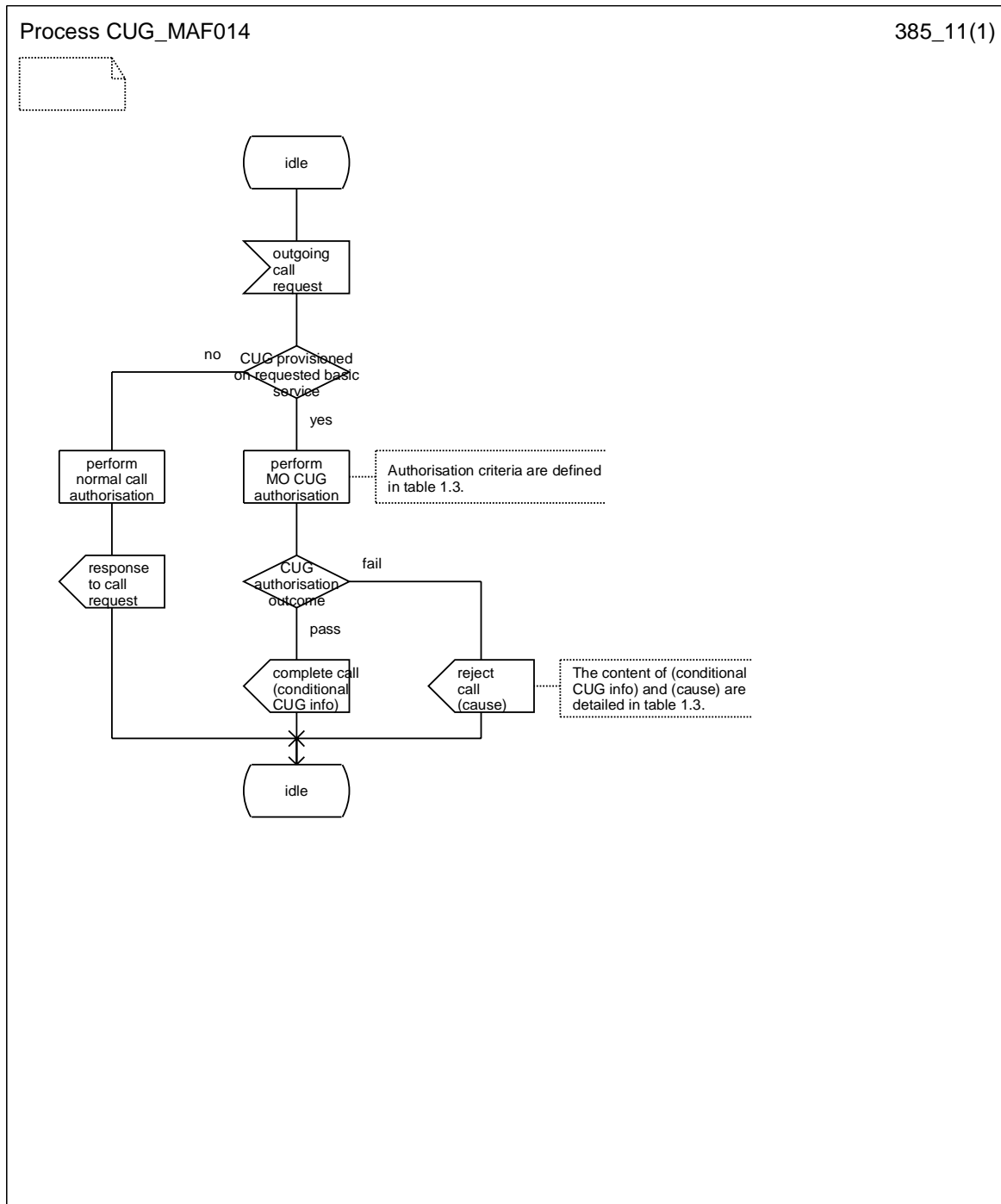
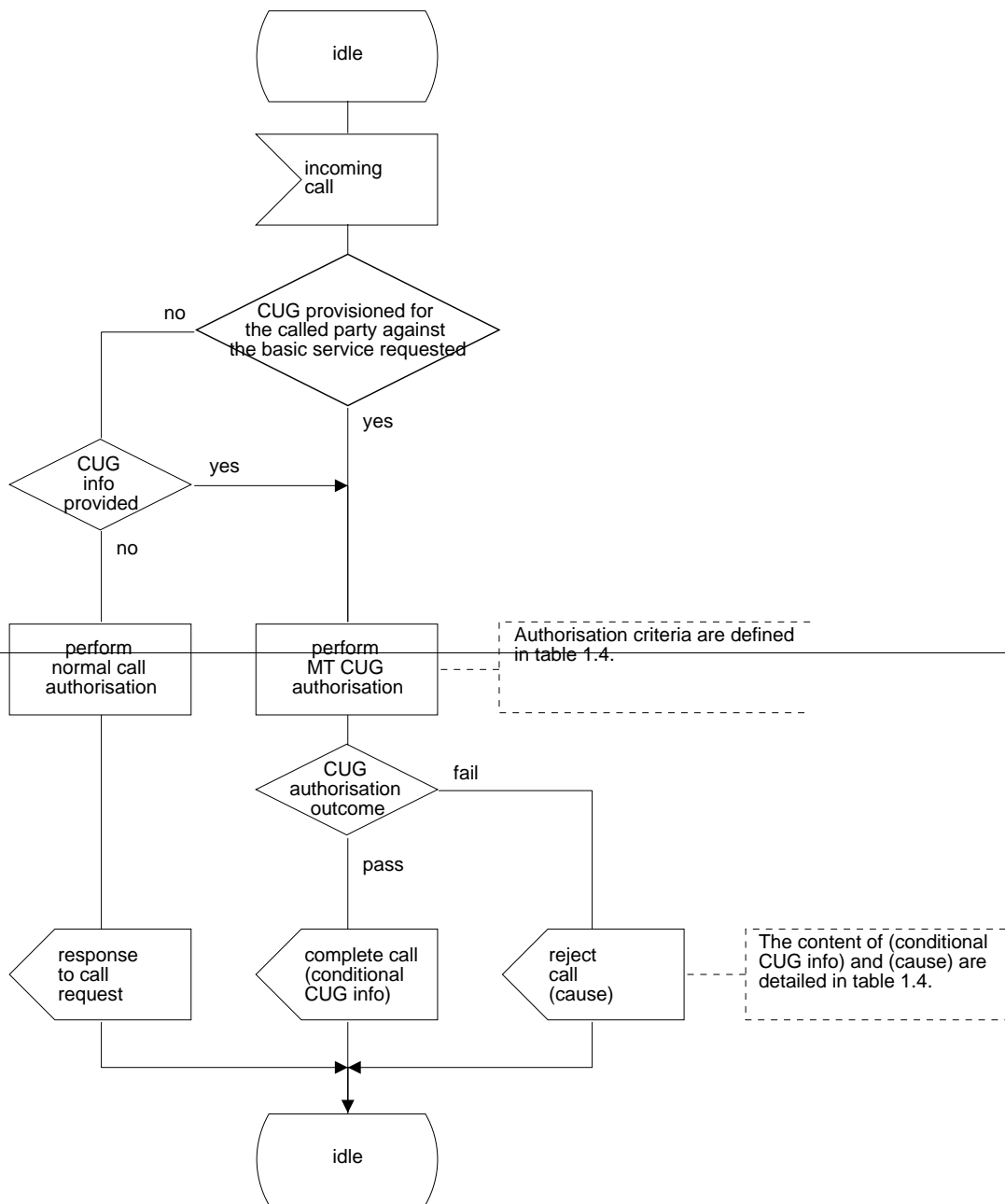

Figure 1.1: MAF014 Mobile Originated CUG call authorisation (VLR)

Process CUG_MAF015

385_12(1)



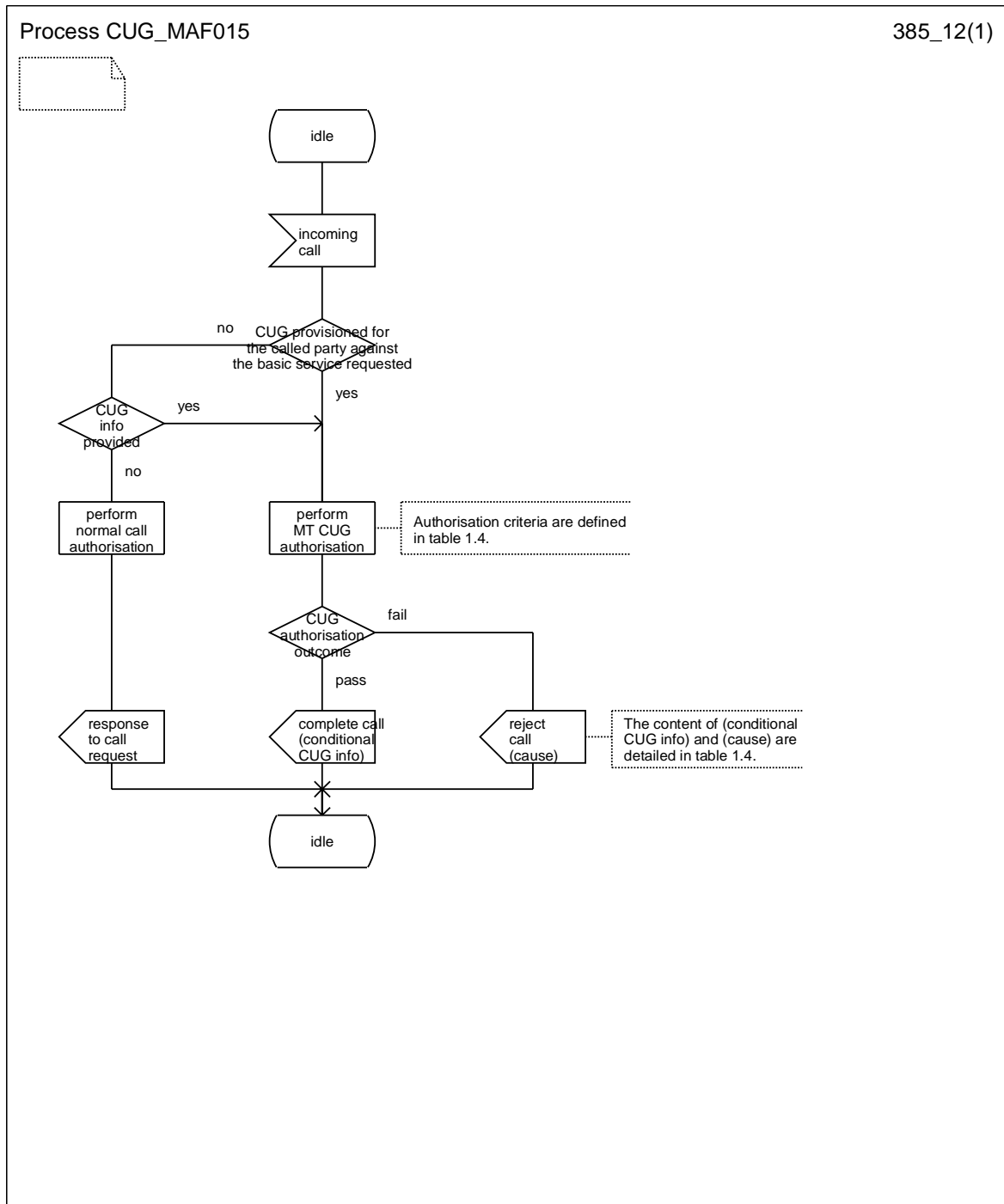

Figure 1.2: MAF015 Mobile Terminated CUG call authorisation (HLR)

CHANGE REQUEST		Please see embedded help file at the bottom of this page for instructions on how to fill in this form correctly.	
23.086 CR 001		Current Version: 3.0.1	
GSM (AA.BB) or 3G (AA.BBB) specification number ↑		↑ CR number as allocated by MCC support team	
For submission to: CN#09	for approval <input checked="" type="checkbox"/>	strategic <input type="checkbox"/>	(for SMG use only)
<i>list expected approval meeting # here</i> ↑	for information <input type="checkbox"/>	non-strategic <input checked="" type="checkbox"/>	

Form: CR cover sheet, version 2 for 3GPP and SMG The latest version of this form is available from: <ftp://ftp.3gpp.org/Information/CR-Form-v2.doc>

Proposed change affects: (U)SIM ME UTRAN / Radio Core Network
(at least one should be marked with an X)

Source: N4 **Date:** 2000-06-26

Subject: SDL refresh

Work item: TEI

Category:	F Correction <input type="checkbox"/> A Corresponds to a correction in an earlier release <input type="checkbox"/> B Addition of feature <input type="checkbox"/> C Functional modification of feature <input type="checkbox"/> D Editorial modification <input checked="" type="checkbox"/>	Release:	Phase 2 <input type="checkbox"/> Release 96 <input type="checkbox"/> Release 97 <input type="checkbox"/> Release 98 <input type="checkbox"/> Release 99 <input checked="" type="checkbox"/> Release 00 <input type="checkbox"/>
(only one category Shall be marked With an X)			

Reason for change: The SDL diagrams in this document have been replaced, without any semantic changes due to the following reasons:

- In the previous version, the diagrams contained nothing but garbage when viewed on-screen.
- Some of the diagrams were, if not impossible, very hard to print.
- A binary version of the SDL diagrams, suitable for standard tools, is needed to assure a qualitative handling of the diagrams in the future. Telelogic Tau SDL Suite (formerly known as SDT) versions of the diagrams have been created and made available, providing a new fresh base for future changes. For obvious reasons, the binary version, to be regarded as the source, should be mirrored in the document. Therefore, the diagrams replacing the previous versions are printouts of the binary versions.

Clauses affected: All figures in the document, containing an SDL diagram.

Other specs Affected:	Other 3G core specifications <input type="checkbox"/> Other GSM core specifications <input type="checkbox"/> MS test specifications <input type="checkbox"/> BSS test specifications <input type="checkbox"/> O&M specifications <input type="checkbox"/>	→ List of CRs: → List of CRs: → List of CRs: → List of CRs: → List of CRs:	
------------------------------	---	--	--

Other comments: ETSI plans to make the binary versions of the SDL diagrams available on the 3GPP website.

1.3 Advice of Charge (Information) information flow diagram

The Advice of Charge (Information) information flow diagrams are shown in figure 1.3.

Process AoCI_MSC

386_11(1)

Figure 1.1

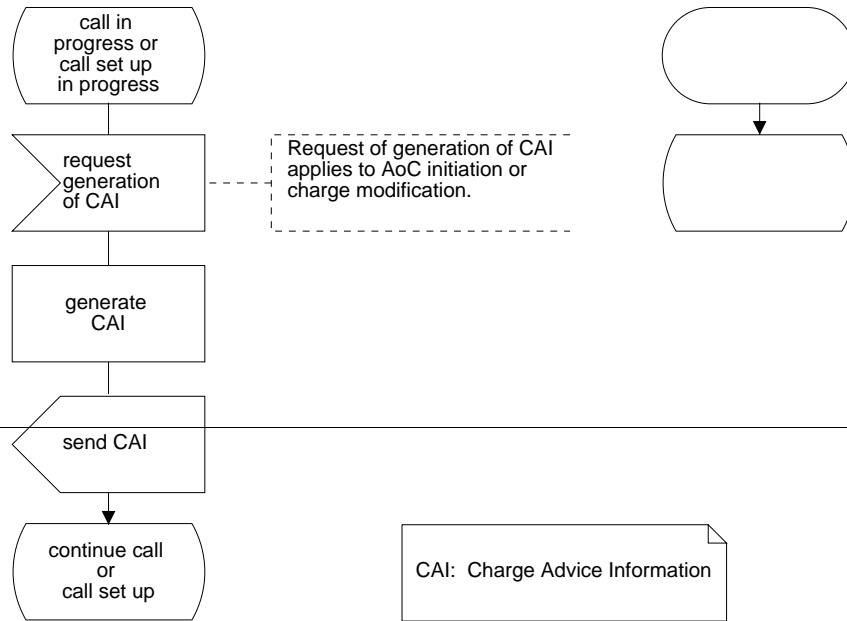

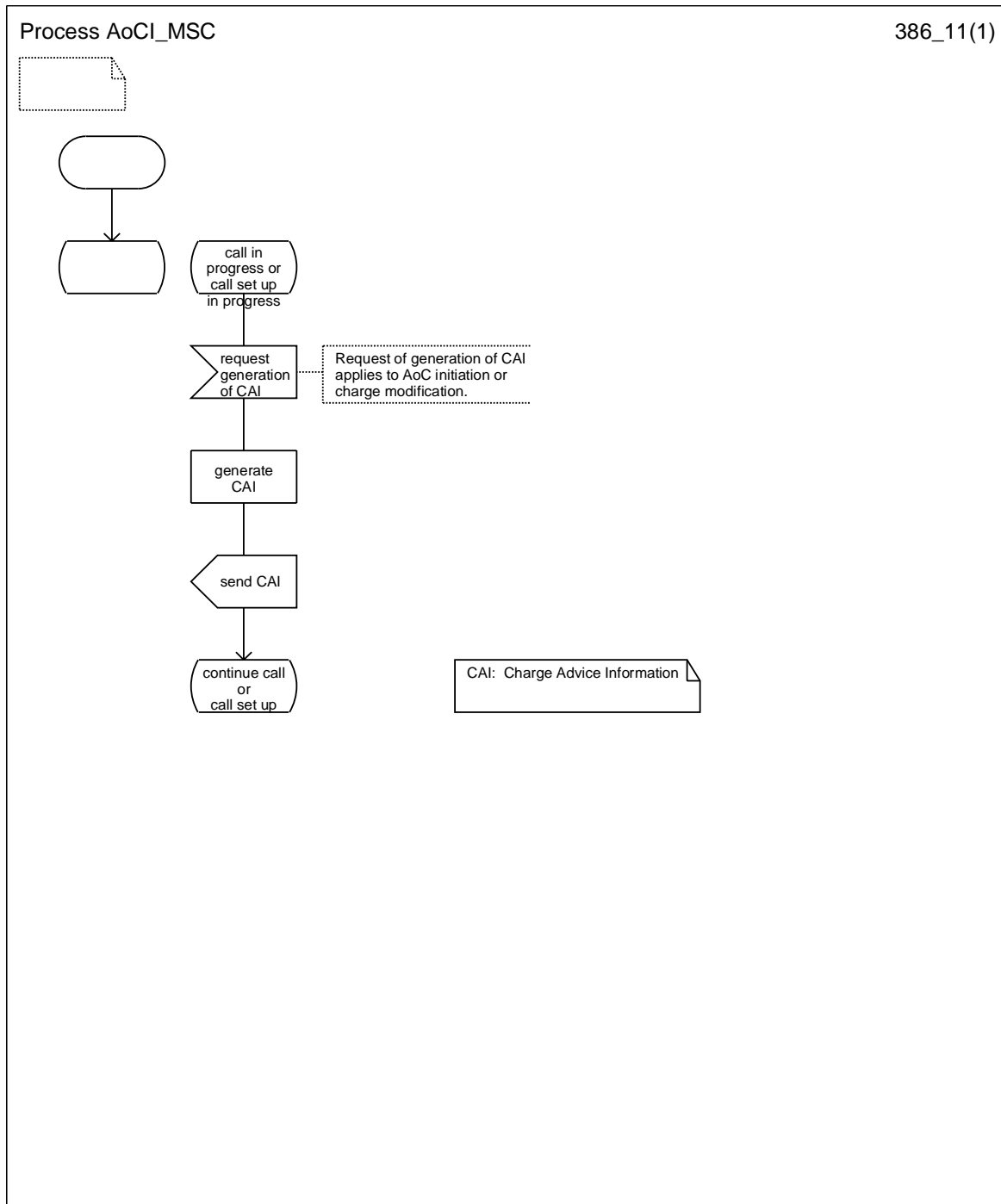
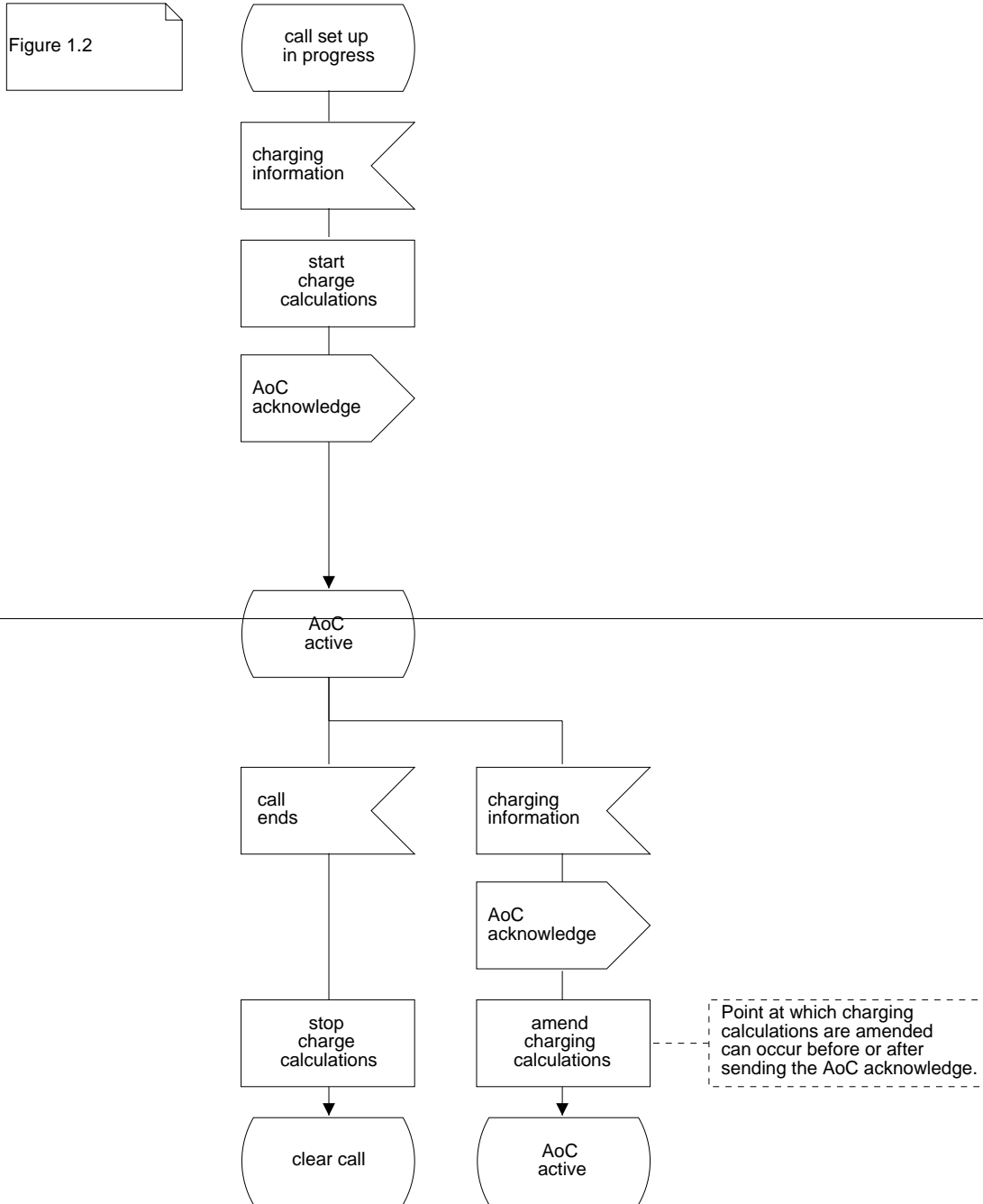

Figure 1.1: SDL diagram of advice of charge (information) in the MSC

Process AoCI_ME

386_12(1)



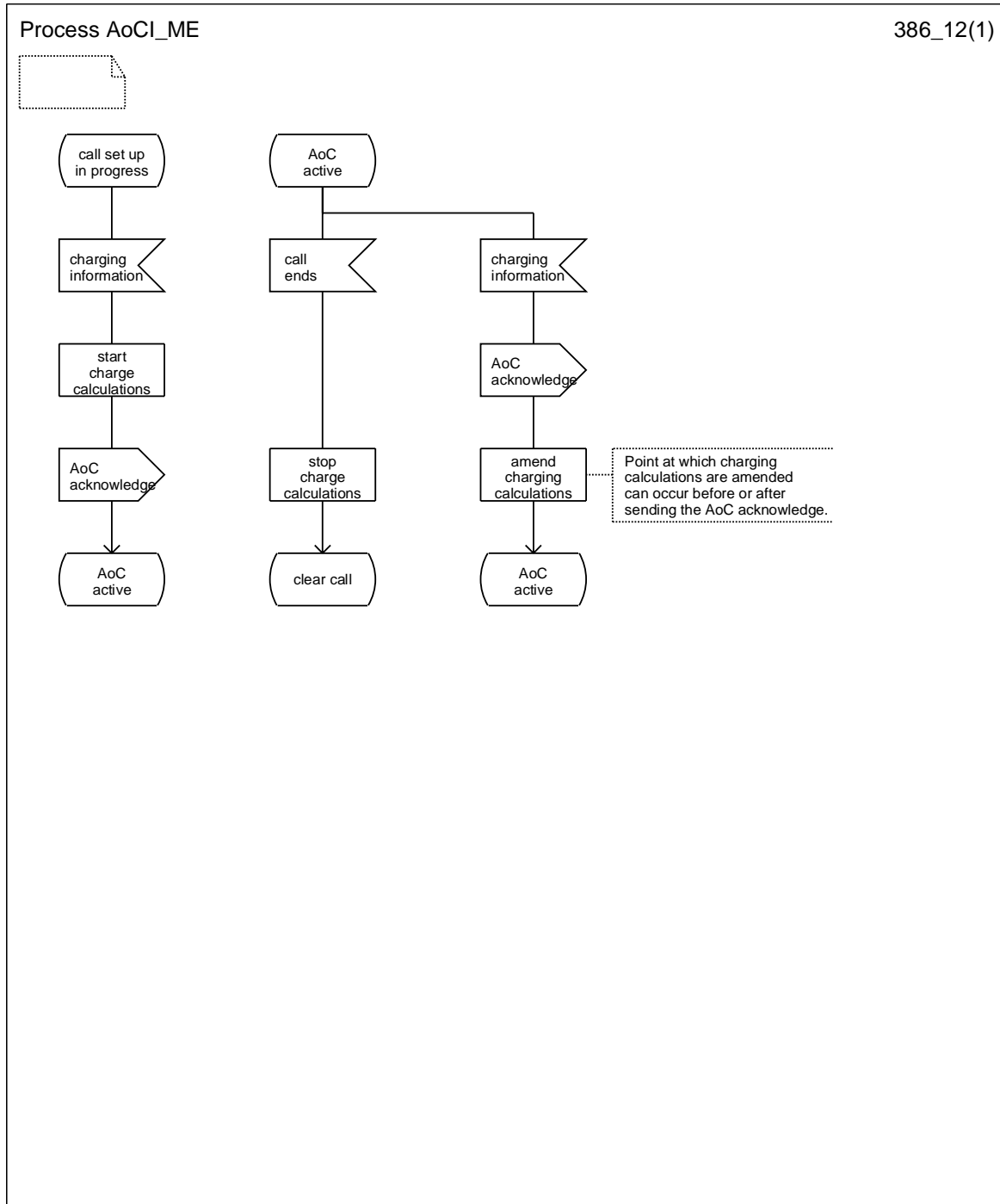

Figure 1.2: SDL diagram of advice of charge (information) in the mobile equipment

1.4 Information stored in the HLR

AoCI may have the following logical states (refer to GSM 03.11 for an explanation of the notation):

Provisioning State	Registration State	Activation State	HLR Induction State
(Not Provisioned,	Not Applicable,	Not Active,	Not Induced)
(Provisioned,	Not Applicable,	Active and Operative,	Not Induced)

The HLR shall store the logical state of AoCI (which shall be one of the valid states listed above) on a per subscriber basis.

1.5 State transition model

The following figure shows the successful cases of transition between the applicable logic states of AoCI. The state changes are caused by actions of the service provider.

Note that error cases are not shown in the diagram as they normally do not cause a state change. Additionally, some successful requests may not cause a state change. Hence they are not shown in the diagram.

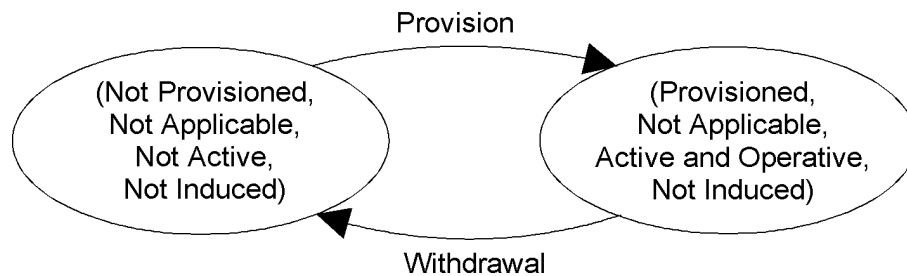

Figure 1.4: State transition model for AoCI

1.6 Transfer of Information from HLR to VLR

If the provisioning state for AoCI is "Provisioned" then when the served subscriber registers on a VLR the HLR shall send that VLR information about the logical state of AoCI.

If the logical state of AoCI is changed while a subscriber is registered on a VLR, then the HLR shall inform the VLR of the new logical state of AoCI.

1.7 Information stored in the VLR

For the supplementary service AoCI the VLR shall store the service state information received from the HLR.

1.8 Handover

Handover will have no impact on AoC control procedure.

2 Advice of Charge (Charging) (AoCC)

2.1 Advice of Charge (Charging) MSC SDL diagram

The SDL diagram for the Advice of Charge (Charging) supplementary service within the MSC is given in figure 2.1. At invocation of the Advice of Charge (Charging) supplementary service the network shall send the "Charging" MS the CAI. The network shall allow the call to proceed whilst waiting for an acknowledgement of the CAI. The waiting period is governed by Timer T(AoC). On expiry of T(AoC) the network shall initiate call clearing.

NOTE 1: AoC (Charging) is not applicable to emergency calls.

NOTE 2: The request of generation of CAI applies to AoC initiation or charge modification.

2.2 Advice of Charge (Charging) mobile equipment SDL diagram

The SDL diagram for the Advice of Charge (Charging) supplementary service within the mobile equipment is given in figure 2.2. The SDL indicates when charging calculations are started, amended and stopped, within the mobile equipment. The mobile equipment should start charging calculations as soon as possible after receiving the charging information. Charging calculations should be emended by the mobile equipment in accordance with GSM 02.24.

NOTE: The point at which charging calculations are amended can occur before or after sending the AoC Acknowledge.

Charging calculations are stopped when the call ends for any reason.

The reception of the CAI shall be acknowledged only if the MS supports the AoCC functionality specified in GSM 02.24 and GSM 02.86.

For mobile originated calls, the MS shall prevent a call set-up attempt if the ACM value is equal to or greater than ACMmax.

For mobile terminated calls, a call set-up attempt shall be allowed even if the ACM value is equal to or greater than ACMmax. In this case, when the MS detects that this is a chargeable call and that the ACM value is equal to or greater than ACMmax then the call shall be released.

During an active call, when the MS detects that ACM is equal to or greater than ACMmax then the MS shall release the call.

2.3 Advice of Charge (Charging) information flow diagram

The Advice of Charge (Charging) information flow diagrams are shown in figure 2.3.

2.4 AoCC subscriber roaming requirements

When an AoCC subscriber first roams into an MSC area not supporting AoCC, or the subscription is given to him while he is roaming in an MSC area not supporting AoCC the following applies:

The HLR shall indicate to the VLR that roaming is restricted in this MSC area due to unsupported feature, and it prevents further mobile terminated traffic. In this case the MS is not reachable.

When entering an AoCC supporting area the AoCC related roaming restriction shall be removed in the HLR.

When AoCC is withdrawn the AoCC related roaming restriction shall be removed in the HLR and VLR. This is independent from roaming restrictions due to other reasons.

Process AoCC_MSC

386_21(1)

Figure 2.1

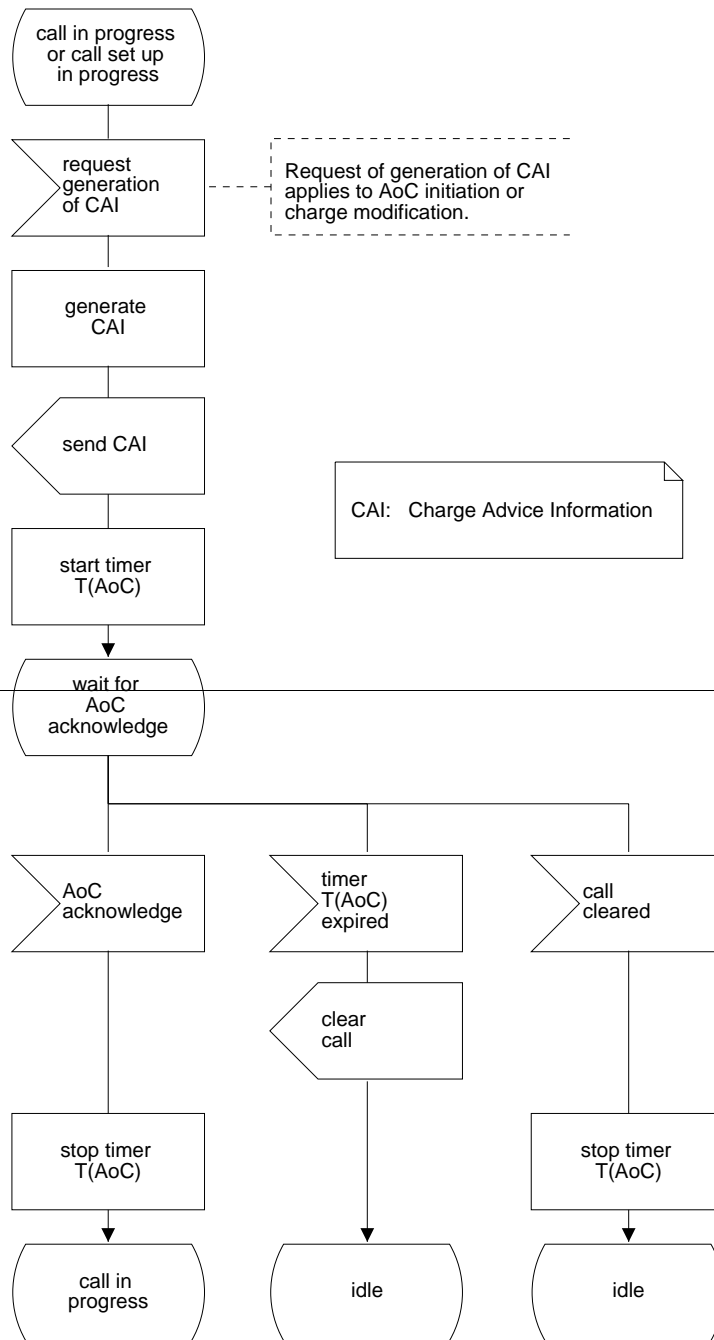

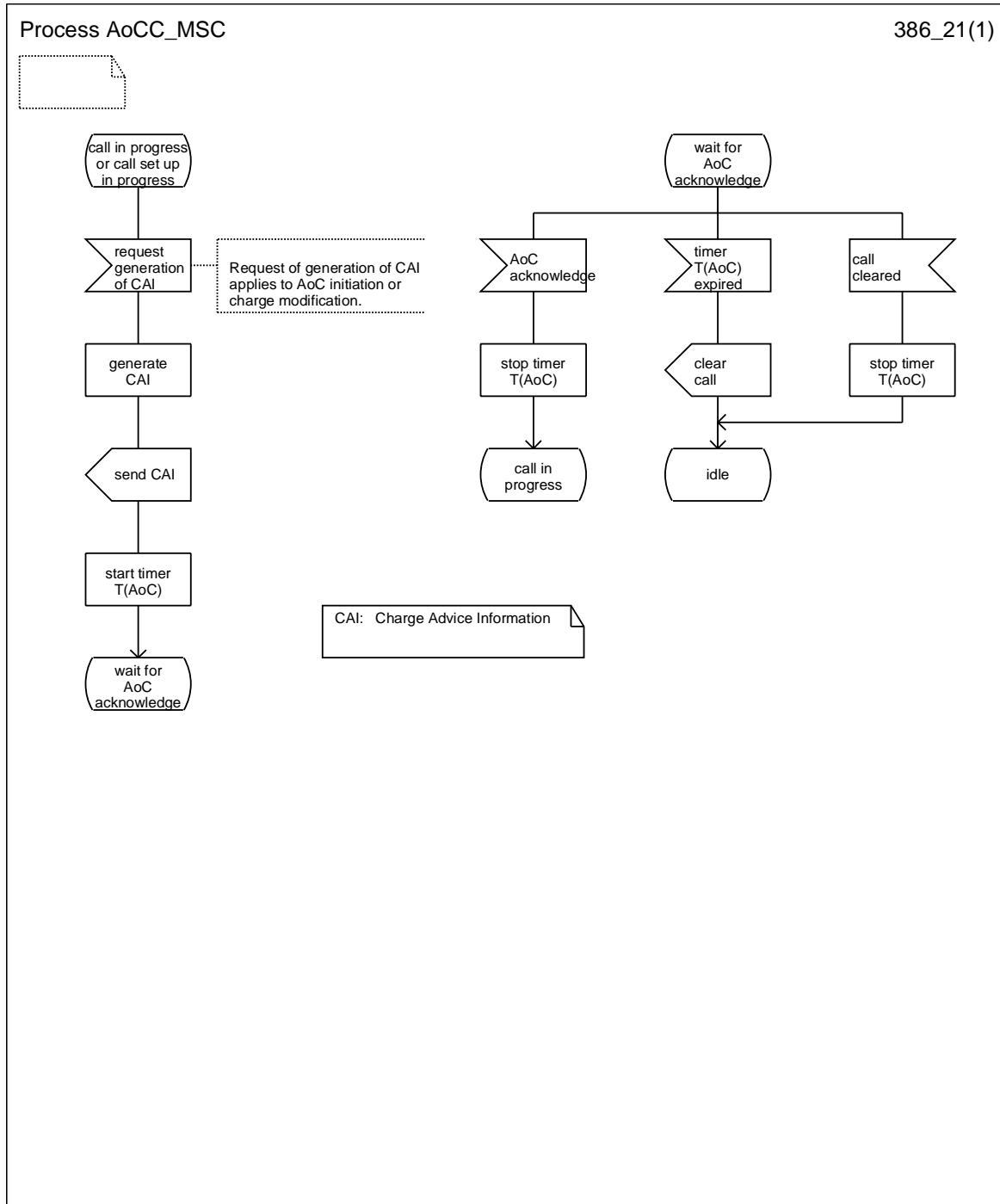
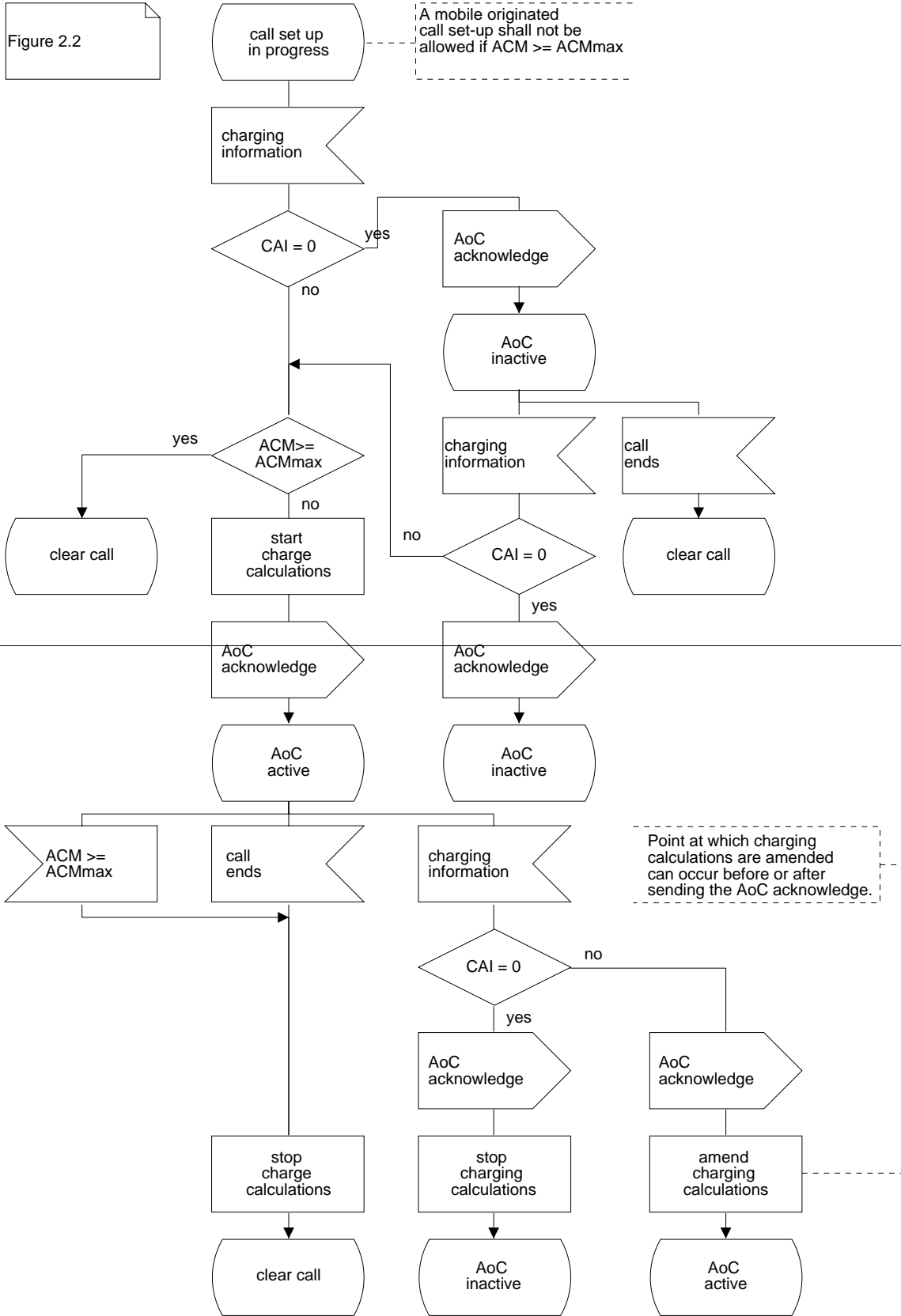

Figure 2.1: SDL diagram of advice of charge (charging) in the MSC

Process AoCC_ME

386_22(1)



CHANGE REQUEST

Please see embedded help file at the bottom of this page for instructions on how to fill in this form correctly.

23.087 CR 001

Current Version: **3.0.1**

GSM (AA.BB) or 3G (AA.BBB) specification number ↑

↑ CR number as allocated by MCC support team

For submission to: **CN#09**
 list expected approval meeting # here ↑

for approval
 for information

strategic
 non-strategic (for SMG use only)

Form: CR cover sheet, version 2 for 3GPP and SMG The latest version of this form is available from: <ftp://ftp.3gpp.org/Information/CR-Form-v2.doc>

Proposed change affects: (U)SIM ME UTRAN / Radio Core Network
 (at least one should be marked with an X)

Source: N4 **Date:** 2000-06-26

Subject: SDL refresh

Work item: TEI

Category:	F Correction	<input type="checkbox"/>	Release:	Phase 2	<input type="checkbox"/>
(only one category)	A Corresponds to a correction in an earlier release	<input type="checkbox"/>		Release 96	<input type="checkbox"/>
Shall be marked	B Addition of feature	<input type="checkbox"/>		Release 97	<input type="checkbox"/>
With an X)	C Functional modification of feature	<input type="checkbox"/>		Release 98	<input type="checkbox"/>
	D Editorial modification	<input checked="" type="checkbox"/>		Release 99	<input checked="" type="checkbox"/>
				Release 00	<input type="checkbox"/>

Reason for change: The SDL diagrams in this document have been replaced, without any semantic changes due to the following reasons:

- In the previous version, the diagrams contained nothing but garbage when viewed on-screen.
- Some of the diagrams were, if not impossible, very hard to print.
- A binary version of the SDL diagrams, suitable for standard tools, is needed to assure a qualitative handling of the diagrams in the future. Telelogic Tau SDL Suite (formerly known as SDT) versions of the diagrams have been created and made available, providing a new fresh base for future changes. For obvious reasons, the binary version, to be regarded as the source, should be mirrored in the document. Therefore, the diagrams replacing the previous versions are printouts of the binary versions.

Clauses affected: All figures in the document, containing an SDL diagram.

Other specs Affected:	Other 3G core specifications	<input type="checkbox"/>	→ List of CRs:	
	Other GSM core specifications	<input type="checkbox"/>	→ List of CRs:	
	MS test specifications	<input type="checkbox"/>	→ List of CRs:	
	BSS test specifications	<input type="checkbox"/>	→ List of CRs:	
	O&M specifications	<input type="checkbox"/>	→ List of CRs:	

Other comments: ETSI plans to make the binary versions of the SDL diagrams available on the 3GPP website.

5.2.1.2 Information flows

Process MAF043

387_1(1)

Figure 1: User-to-user signalling Service 1 authorisations examinations (VLR)

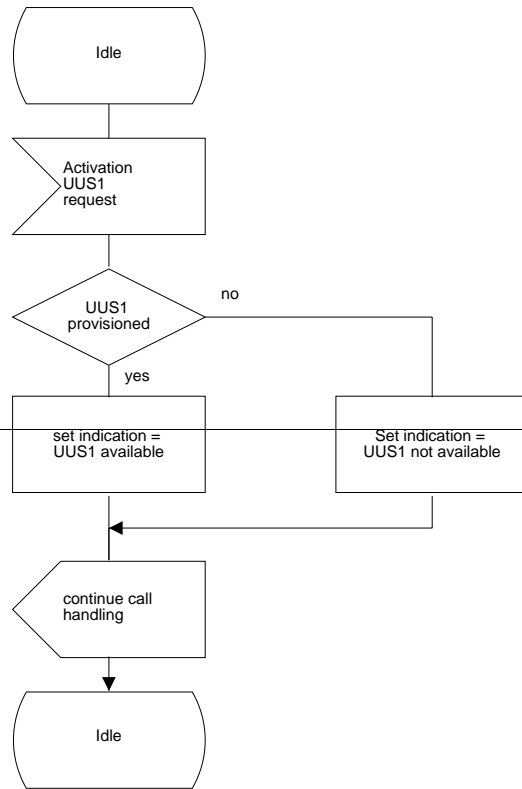

Process MAF043

387_1(1)



User-to-user signalling Service 1
authorisations examinations (VLR)

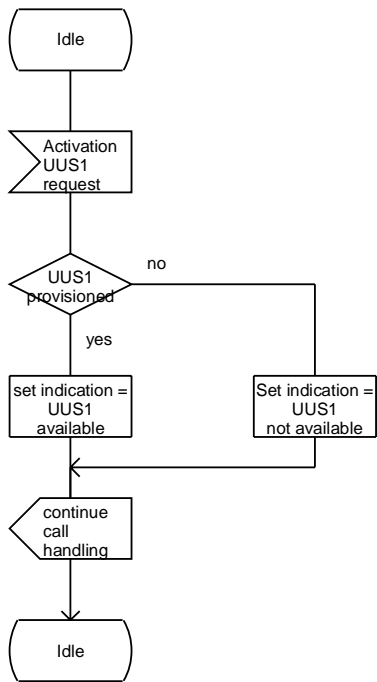

5.2.1.2.1 Implicit activation

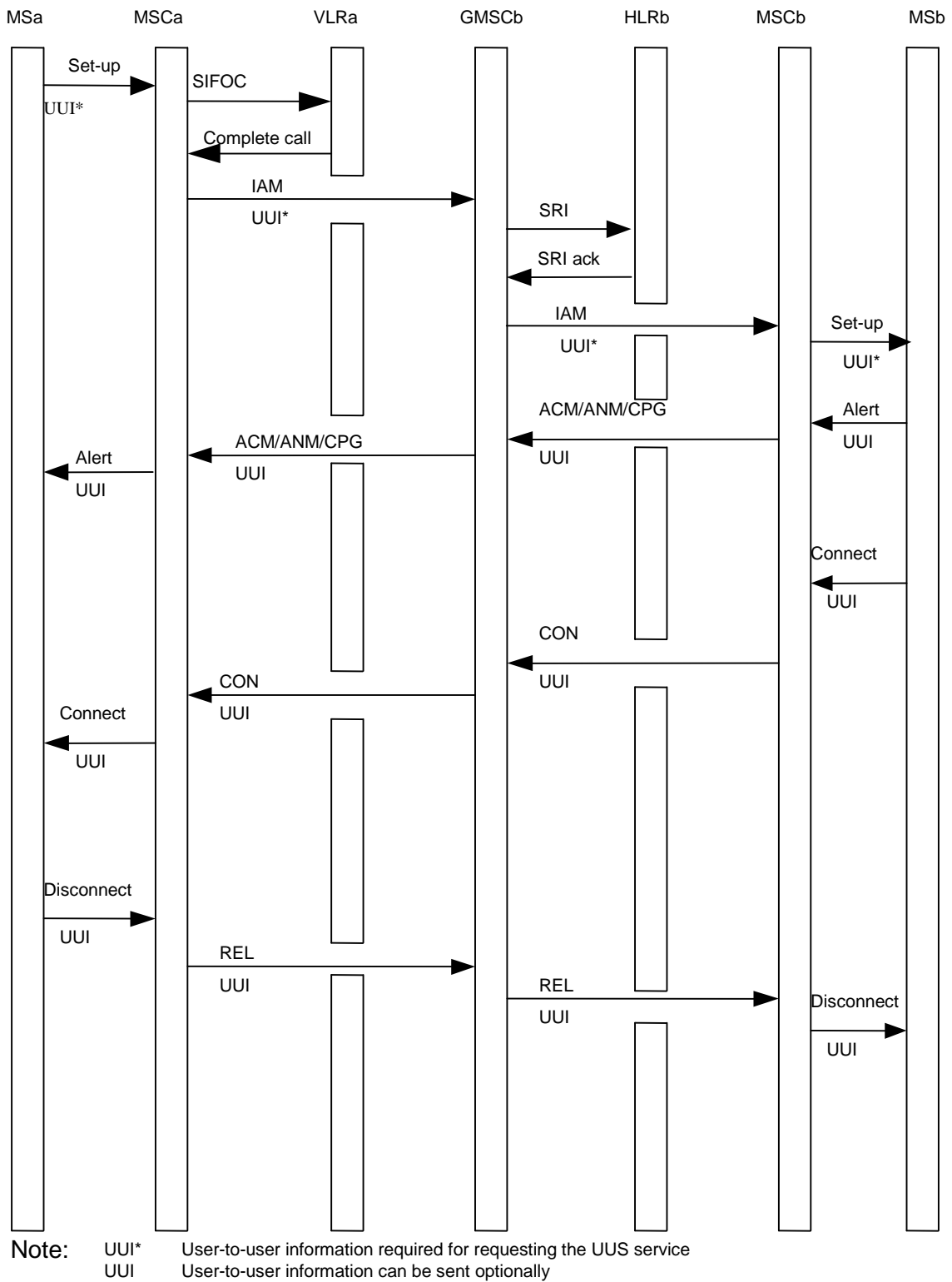
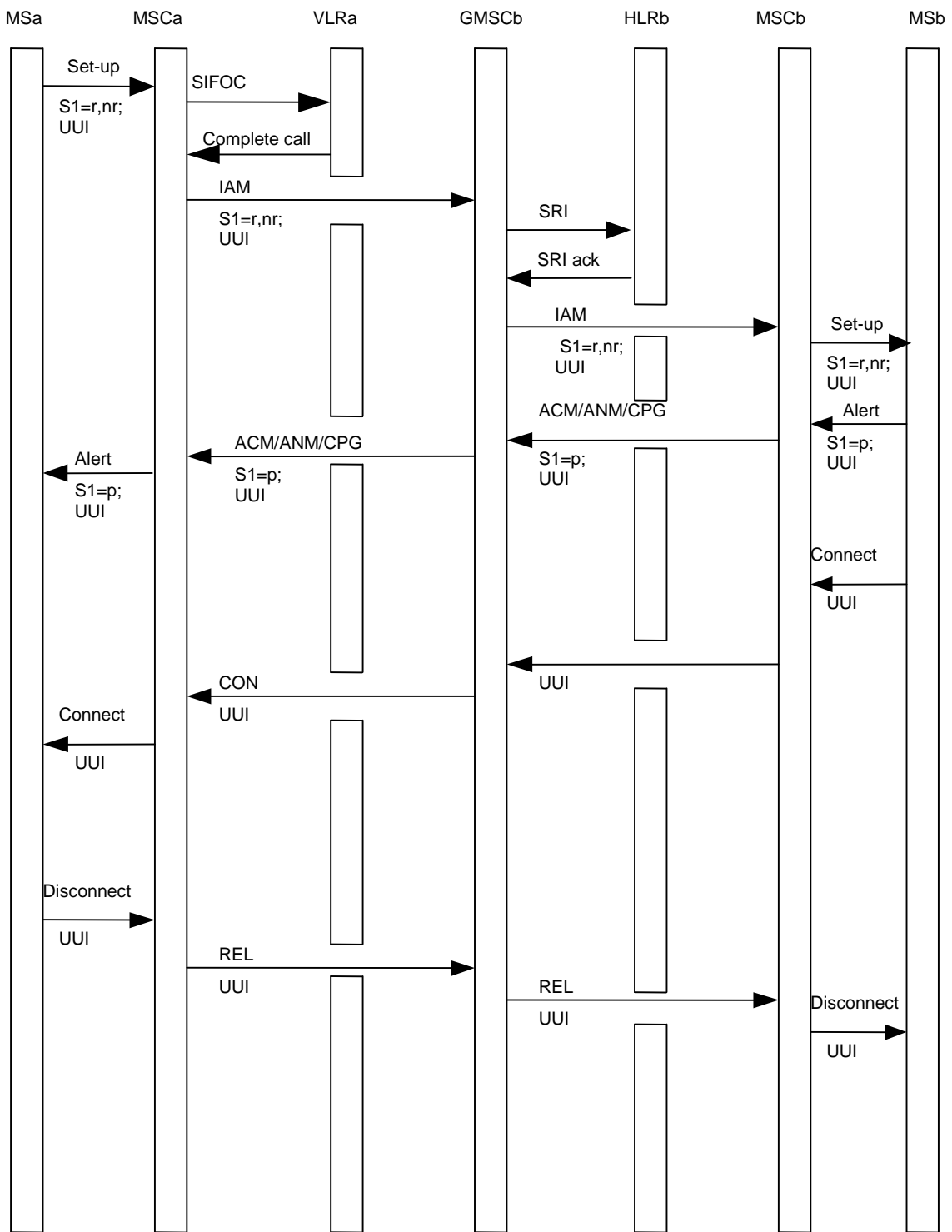

Figure 5.2.1.2.1.1: Information flow for UUS1 implicit request (mobile to mobile call)

5.2.1.2.2 Explicit activation



Note: S1 UUS Service 1
 UUI User-to-user information can be sent optionally
 r,nr requested, not required
 p provided

Figure 5.2.1.2.2.1: Information flow for UUS 1 explicit request (mobile to mobile call)

5.2.2 Service 2 (UUS2)

5.2.2.1 Flow control

Up to two UUI messages can be sent in each direction. If either party tries to send more than two UUI messages, they are discarded.

5.2.2.2 Information flows

Process MAF044

387_5(1)

Figure 5: User-to-user signalling
authorisation examination (VLR)

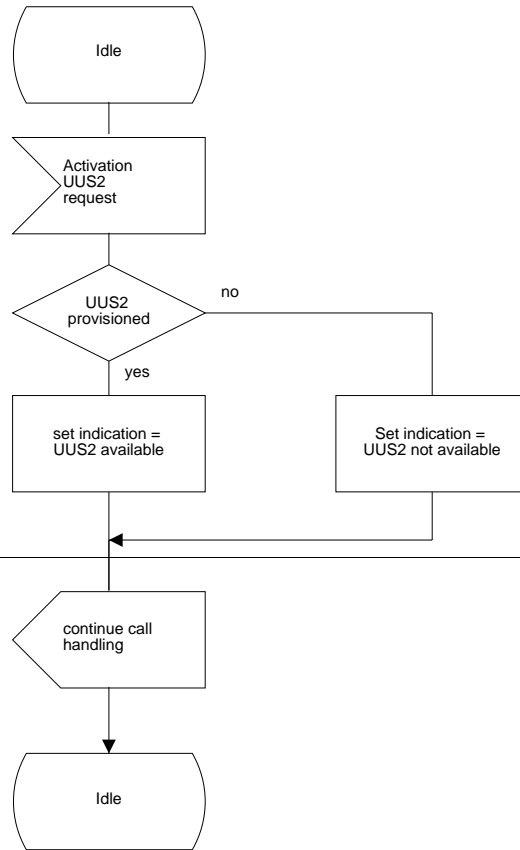

Process MAF044

387_5(1)



User-to-user signalling
authorisation examination (VLR)

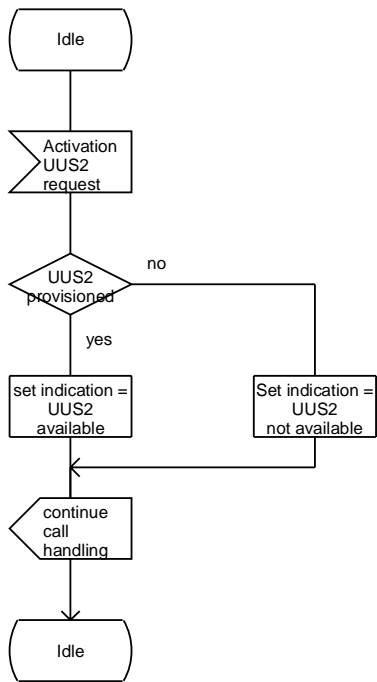

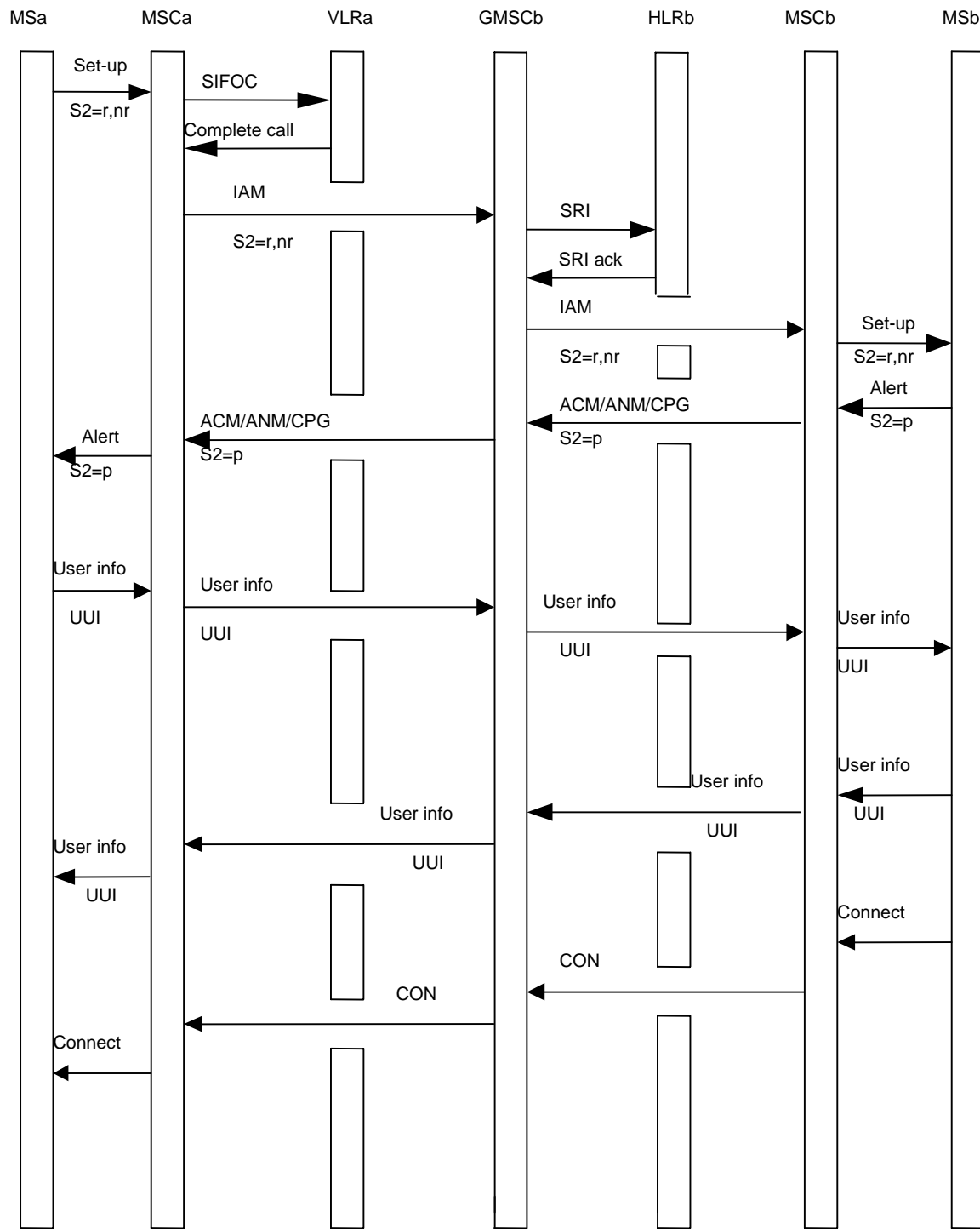

Note: S2 UUS Service 2
 UUI User-to-user information
 r,nr requested, not required
 p provided

Figure 5.2.2.1: Information flow for UUS2 explicit request (mobile to mobile call)

5.2.3 Service 3 (UUS3)

5.2.3.1 Flow control

Network flow control mechanisms shall exist after the connection has been established in order to restrict the amount of UUI sent in each direction. A burst capability of sending N messages shall immediately be available to each user, where N initially equals the value of the burst parameter X. The value of N shall be decremented by one for every message sent by the user and incremented by Y at regular intervals of T2-UUS3 (see table 5.1). The value of N shall be limited to a maximum of X.

The value of the burst parameter X shall be 16.

The value of the replenishment parameter Y shall be 8.

Network flow control shall be performed only by the sending user's network.

If the MSC receives UUI messages from the MS at a rate which exceeds the flow control limit, it shall discard the UUI messages that cannot be handled and respond to the first discarded UUI message with a congestion control message.

When the flow control restrictions are removed, an indication that further UUI messages can be accepted shall be given. See the Processes `Serving_MSC_Handle_UUS_In_Active_Call` and `Remote_MSC_Handle_UUS_In_Active_Call`.

5.2.3.2 Information flows

Process MAF045

387_7(1)

Figure 7: User-to-user signalling service 3 related authorisation examination (VLR)

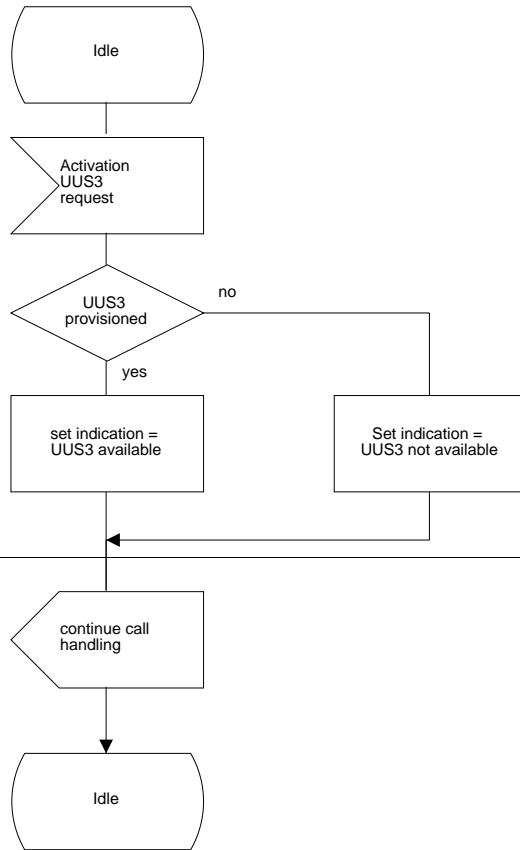

Process MAF045

387_7(1)



User-to-user signalling service 3 related
authorisation examination (VLR)

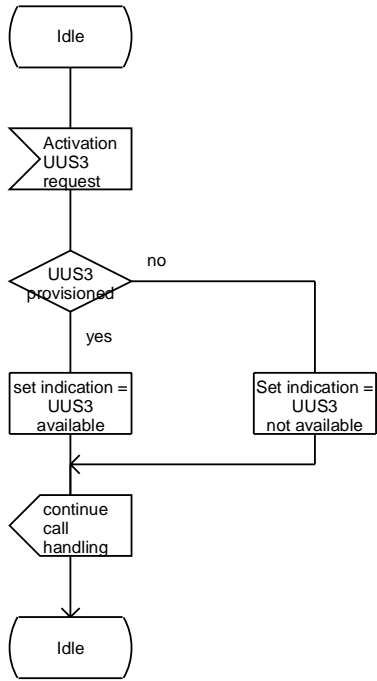

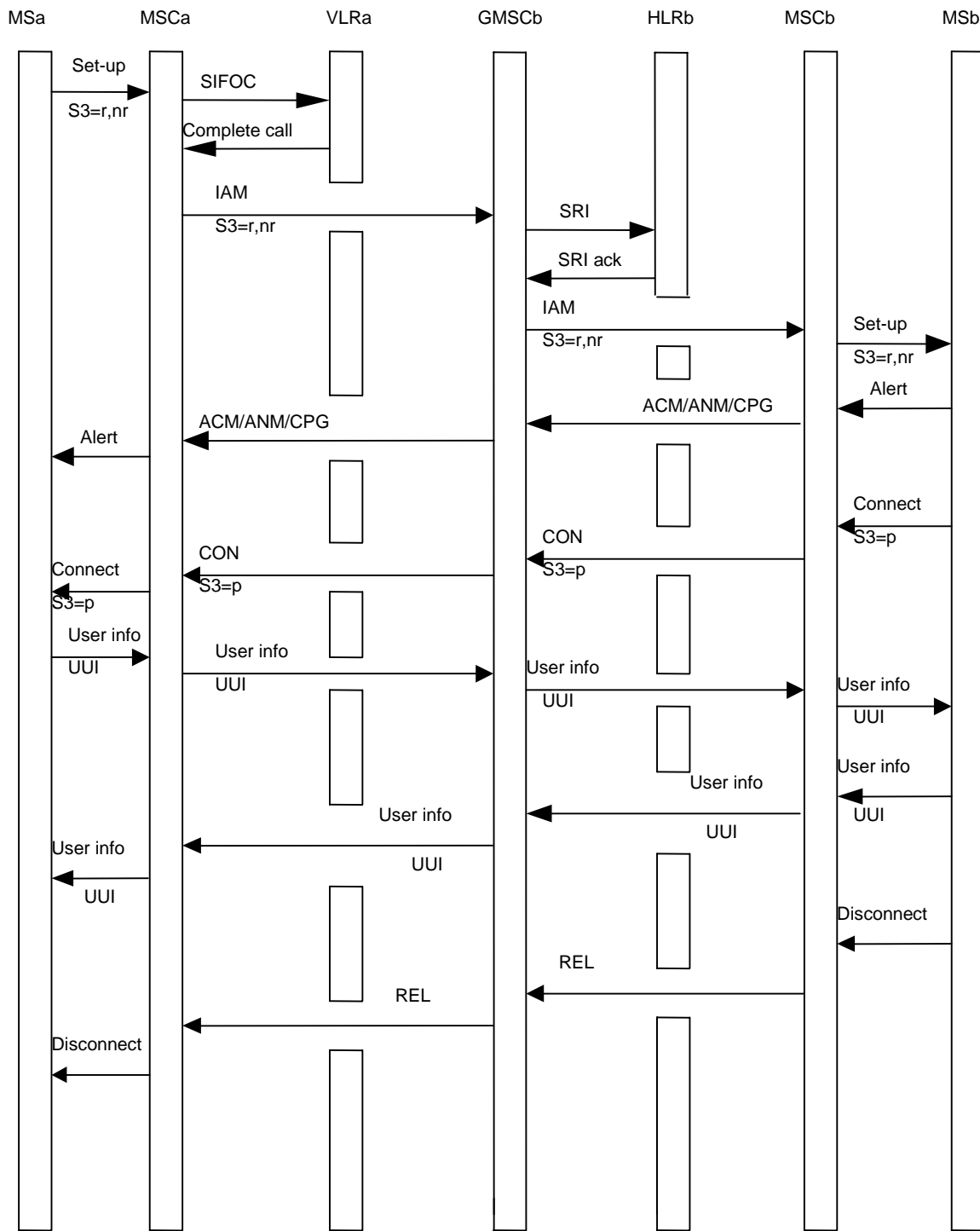

Note: S3 UUS Service 3
 UUI User-to-user information
 r,nr requested, not required
 p provided

Figure 5.2.3.2.1: Information flow for UUS3 explicit request during call establishment (mobile to mobile call)

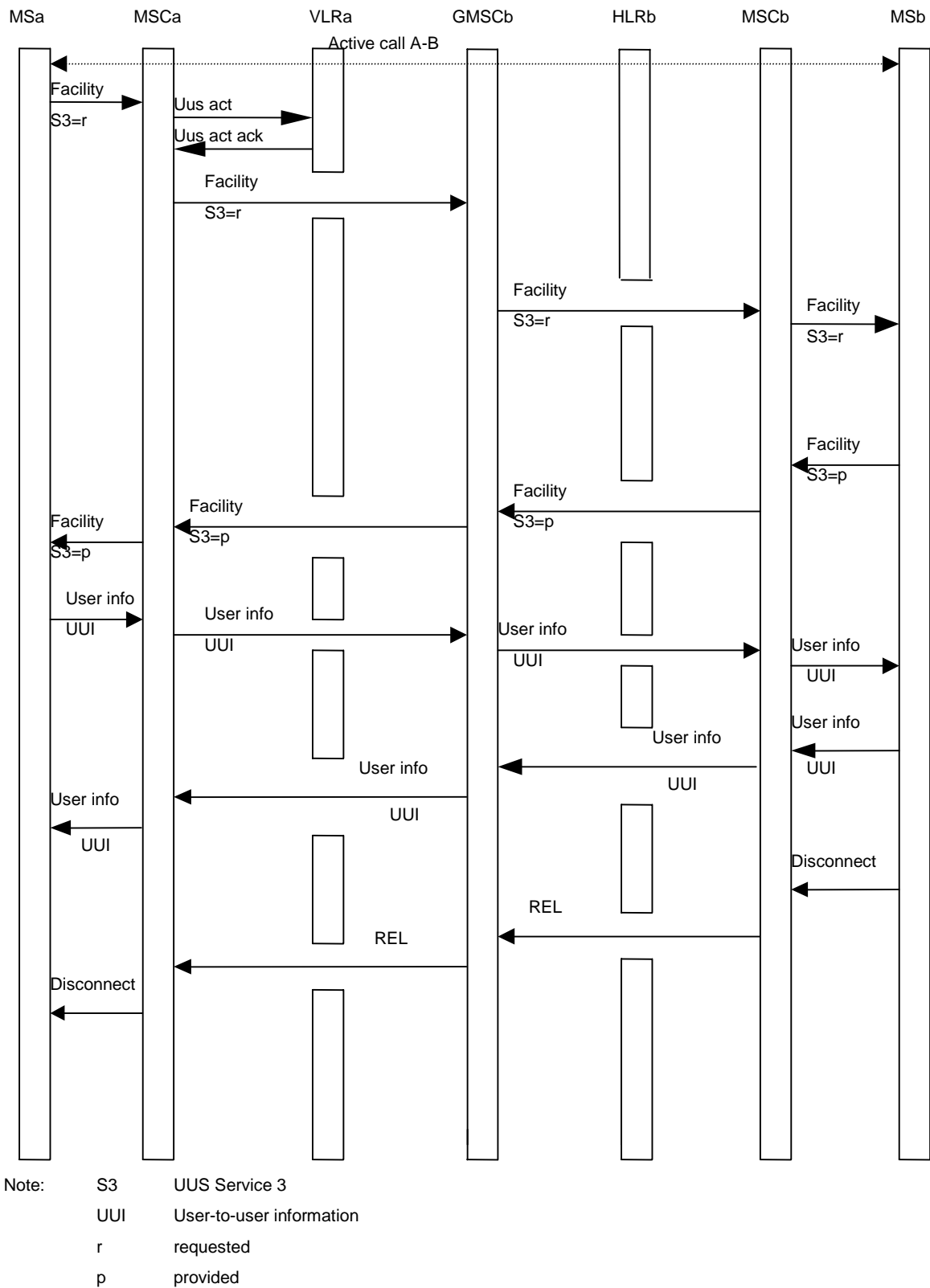

Figure 5.2.3.2.2: Information flow for UUS3 explicit request during active call (mobile to mobile call)

5.3 Messages and their contents

This subclause contains the detailed description of the information flows used by UUS.

Each Information Element, IE is marked as (M) Mandatory, (C) Conditional, or (O) Optional. A mandatory information element shall always be present. A conditional information element shall be present if certain conditions are fulfilled; if those conditions are not fulfilled it shall be absent. An optional information element may be present or absent, at the discretion of the application at the sending entity. This categorisation is a functional classification, i.e. stage 2 information and not a stage 3 classification to be used for the protocol.

The stage 2 and stage 3 message and information element names are not necessarily identical.

5.3.1 Information elements used in the messages

The following UUS specific constructed information elements are used in the messages.

Table 5.3.1.1: UUS specific information elements

Parent Information Element	Child Information Element name	Information element Required	Information element description
UUS options	UUS1	C	The information element is present if UUS1 service is requested; otherwise it shall be absent. It may contain the following values: - Required - Not Required
	UUS2	C	The information element is present if UUS2 service is requested; otherwise it shall be absent. It may contain the following values: - Required - Not Required
	UUS3	C	The information element is present if UUS3 service is requested; otherwise it shall be absent. It may contain the following values: - Required - Not Required
UUS provision	UUS1	C	If UUS1 services is requested and provisioned the information element is present, otherwise it shall be absent.
	UUS2	C	If UUS2 services is requested and provisioned the information element is present, otherwise it shall be absent.
	UUS3	C	If UUS3 services is requested and provisioned the information element is present, otherwise it shall be absent.

5.3.2 Messages between MS and MSC

Call control messages (Setup, Alert, Connect, Disconnect, Release and Release Complete, refer to GSM 04.08) may carry UUS service activation request and response. They can carry also UUI for UUS1.

Facility message, refer to GSM 04.08, can carry UUS service 3 activation request and response.

Dedicated User-To-User message, refer to GSM 04.08, carries UUI for UUS service 2 and 3.

These messages are used both in serving and remote networks.

5.3.3 Messages between MSC and VLR (B interface)

These messages are used in the serving network.

Table 5.3.3.1: Messages between MSC and VLR

Message	Message sender	Information element name	Information element Required	Information element description
Send Info For Outgoing Call	MSC	- UUS options	- C	Refer to GSM 03.18. In addition: The information element is present if MS A requested UUS service; otherwise it shall be absent. The structure of UUS options is defined in table 5.3.1.1
Send Info For Outgoing Call negative response	VLR	- UUS reject	- C	Refer to GSM 03.18 In addition: The information element is present, if required UUS service was requested by MS A and service is not provided, otherwise it shall be absent.
Complete Call	VLR	- UUS provision	- C	Refer to GSM 03.18 In addition: The information element is present if MS A requested UUS service(s); otherwise it shall be absent. The structure of UUS Provision is defined in table 5.3.1.1
Send Info For UUS3	MSC	-	-	The message is sent when UUS3 service is requested during active call. NOTE: This message is used in serving and remote MSCs.
Send Info For UUS3 Ack	VLR	UUS provision	C	The information element is present if UUS3 service is provisioned; otherwise it shall be absent

5.3.4 Messages between MSC – MSC (E interface)

These messages are used in the remote network when UUS is supported in remote MSC in conjunction of SOR, refer to GSM 03.79.

Table 5.3.4.1: Messages between MSC – MSC

Message	Message sender	Information element name	Information element Required	Information element description
Resume Call Handling	MSCB	-	-	Refer to GSM 03.79.
		UUS1 Service request	C	In addition: The information element is present if UUS1 Service was requested in the original call and remote MSC supports UUS service; otherwise it shall be absent. The information element is present if UUS2 Service was requested in the original call and remote MSC supports UUS service; otherwise it shall be absent. The information element is present if UUS3 Service was requested in the original call and remote MSC supports UUS service; otherwise it shall be absent. The information element is present if UUS1 UUI was present in the original call and remote MSC supports UUS service; otherwise it shall be absent. The information element is present if the remote subscriber has accepted UUS1 service request and call forwarding or call deflection has been activated after that; otherwise it shall be absent.
		UUS2 Service request	C	
		UUS3 Service request	C	
		UUS1 UUI	C	
UUS CF interaction	C			

6 Interaction with other supplementary services

GSM 02.87 specifies interaction of UUS with other supplementary services. Additional details are provided in this clause.

6.1 Call forwarding unconditional (CFU)

No impact.

6.2 Call forwarding on mobile subscriber busy (CFB)

No impact, if CFB is invoked due to a NDUB condition or due to UDUB before an alerting message was received from the mobile station.

If CFB is invoked due to a UDUB indication from the B forwarding subscriber the same interaction as for CFNRy shall apply.

6.3 Call forwarding on no reply (CFNRy)

If UUS Service 1 is implicitly requested for a call to a subscriber who has Call Forwarding on no reply active and operative, the forwarding MSC shall store the UUI. If CFNRy is invoked, the stored UUI shall be forwarded with the call.

If UUS Service 1 is explicitly requested as not required for a call to a subscriber who has Call Forwarding on no reply active and operative, the forwarding MSC shall store UUS 1 service request and UUI, if any. If the forwarding user accepts the UUS1 supplementary service request in the Alerting message, the CFNRy supplementary service can be invoked and the stored UUS1 service request and UUI, if any, shall be forwarded with the call. If the forwarding user rejects the UUS1 supplementary service request or does not include a response related to it in the Alerting message, then the CFNRy supplementary service can be invoked but the UUS1 service request and UUI, if any, shall not be forwarded with the call.

If UUS Service 1 is explicitly requested as required for a call to a subscriber who has Call Forwarding on no reply active and operative and the no reply condition timer expires, the remote MSC shall release the call towards the calling subscriber.

If Call Forwarding on no reply is invoked for a call for which UUS Service 2 was requested as not required, UUS Service 2 shall not be requested for the forwarding leg, i.e. UUS 2 is no longer available for the call.

Call Forwarding on no reply shall not be invoked if UUS Service 2 was requested required for the initial mobile terminated call.

If UUS Service 3 is requested for a call to a subscriber who has Call Forwarding on no reply active and operative, the forwarding MSC shall store the UUS3 request. If CFNRy is invoked the UUS3 request shall be forwarded with the call.

For further details refer to procedures UUS_ICH_Check_Forwarding and UUS_MSC_Clear_UUS.

6.4 Call forwarding on mobile subscriber not reachable (CFNRc)

No impact.

6.5 Call waiting (CW)

No impact.

6.6 Call hold (HOLD)

No impact.

6.7 Completion of calls to busy subscribers (CCBS)

Requests for the activation of the UUS supplementary service contained in the original call request shall be maintained along with other call information used for the CCBS supplementary service.

The network shall also store any UUI containing in the original call request and use this stored UUI in the CCBS call.

6.8 Explicit call transfer (ECT)

When calls are transferred as a result of invocation of explicit call transfer supplementary service, the UUS supplementary service activated on either of the calls prior to the invocation of the explicit call transfer supplementary service shall be cancelled by the network.

No specific notification shall be sent to the users on the resulting call when the UUS supplementary service is no longer activated.

The users on the resulting call can request service 3 again, if required.

6.9 Multi party service (MPTY)

No impact.

6.10 Advice of charge (AoC)

No impact.

6.11 Barring of outgoing calls (BAOC)

No impact.

6.12 Barring of outgoing international calls (BOIC)

No impact.

6.13 Barring of outgoing international calls except those directed to the home PLMN country (BOIC-exHC)

No impact.

6.14 Barring of incoming calls (BAIC)

No impact.

6.15 Barring of incoming calls when roaming outside the home PLMN country (BIC-Roam)

No impact.

6.16 Call deflection (CD)

If Call Deflection is invoked before alerting there is no impact.

If Call Deflection is invoked after alerting the same interactions as for Call forwarding on no reply shall apply.

7 Interaction with other network features

7.1 Customised Applications for Mobile network Enhanced Logic (CAMEL)

No impact.

7.2 Support for Optimal Routeing(SOR)

The invocation of Optimal Routeing in case of late call forwarding shall have no impact on the interactions of UUS with the call forwarding supplementary services as defined in clause 6.

The UUS request, UUI and UUS CF interaction indicator, if any, shall be added to the Resume Call Handling message in remote MSC when SOR late call forwarding is applied. For details refer to the procedure UUS_ICH_Handle_LCF in SDLs and the procedure Handle_ORLCF_VMSC (see GSM 03.79).

The UUS request and UUI, if any, shall be copied from the Resume Call Handling message to the IAM in GMSC when SOR late call forwarding is applied. For details refer to the procedure UUS_GMSC_Check_Forwarding in SDLs and the procedure OR_Handle_RCH (see GSM 03.79).

If UUS CF interaction indicator was present in Resume Call Handling message, the presence of UUS1 Service acceptance and UUI, if any, shall be modified during call setup time. For further details refer to the procedure MT_CF_MSC (see GSM 03.18) and UUS_MSC_Clear_UUS.

8 Interworking with other networks

8.1 Interworking with GSM PLMN/ISDN network supporting only a maximum User-user information element length of 35 octets

If interworking occurs with a network supporting only a maximum of User-user information element length of 35 octets, no notification shall be given to the calling user or called user sending the user information.

8.2 Interworking with non-ISDN network

In the case of interworking with non-ISDN network or with a non-ISDN called user, a progress indicator information element indicating #1 "call is not end-to-end ISDN; further progress information may be available in-band" or #2 "destination address is non-ISDN", respectively, is sent to the calling user as part of basic call.

This progress information shall serve as indication that the requested service cannot be guaranteed.

9 Network entity functions

9.1 Originating network processes

9.1.1 Procedures in MSC

Figure 9.1.1.1 Procedure UUS_OCH_Check_Setup

This procedure is called when Setup is received from A-subscriber. It sets requested UUS service options into SIFOC message.

Figure 9.1.1.2 Procedure UUS_OCH_Set_Info_In_IAM

Requested UUS service options and possible UUS1 data is copied in IAM. The procedure is controlled by the Complete Call message parameters from the VLR.

Figure 9.1.1.3 Procedure UUS_OCH_Set_Alert_And_Connect_Param

In this procedure UUS related parameters are checked and set into the Alerting/Connect message that is sent to A-subscriber. If any of the UUS services is requested as required and positive service acknowledgement is not received from the remote end, the check will fail and the call will be cleared.

Procedure UUS_OCH_Check_Setup

1(1)

This procedure is running in the MSC and sets the UUS specific parameters to SIFOC message

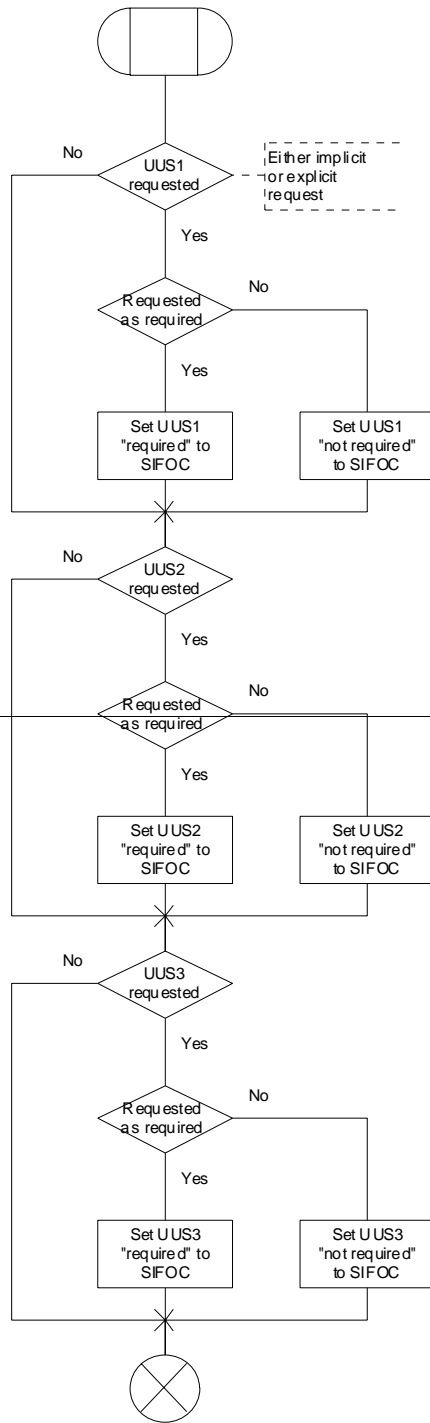

Procedure UUS_OCH_Check_Setup

1(1)



This procedure is running in the MSC and sets the UUS specific parameters to SIFOC message

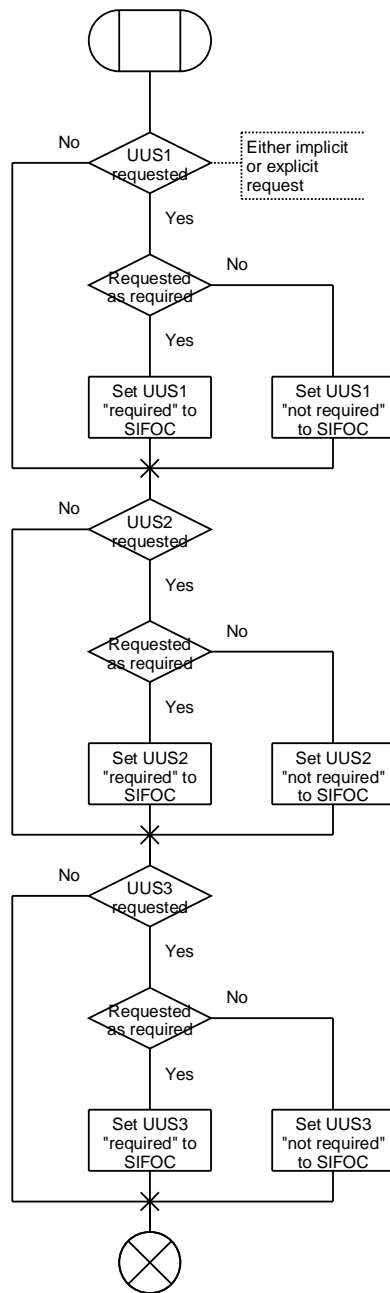

Figure 9.1.1.1: Procedure UUS_OCH_Check_Setup

Procedure UUS_OCH_Set_Info_In_IAM

1(1)

This procedure is running in the MSC and it sets UUS specific parameters to the IAM message

S1 = UUS Service 1
S2 = UUS Service 2
S3 = UUS Service 3
r, nr = requested, not required
r,r = requested, required

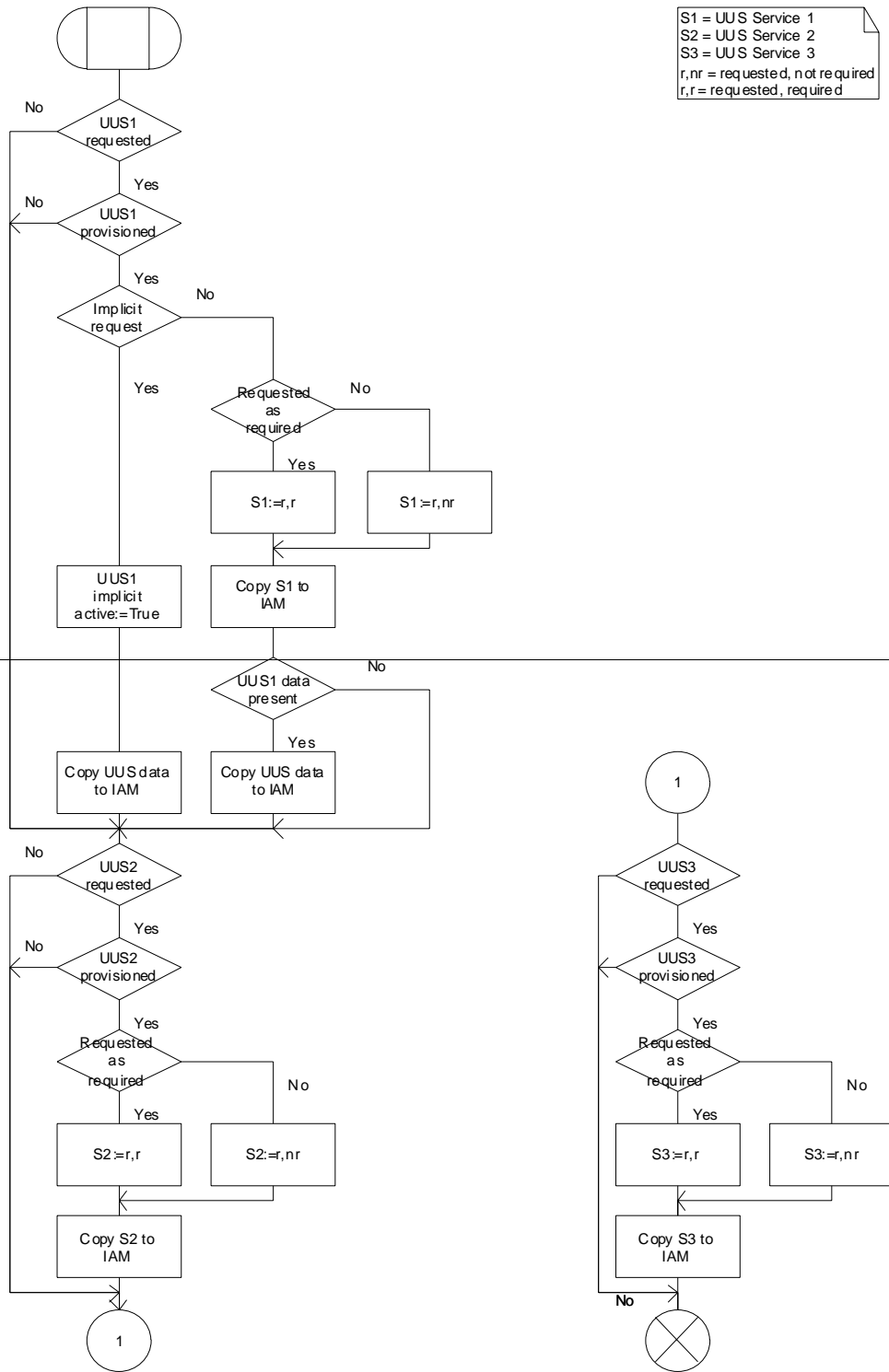

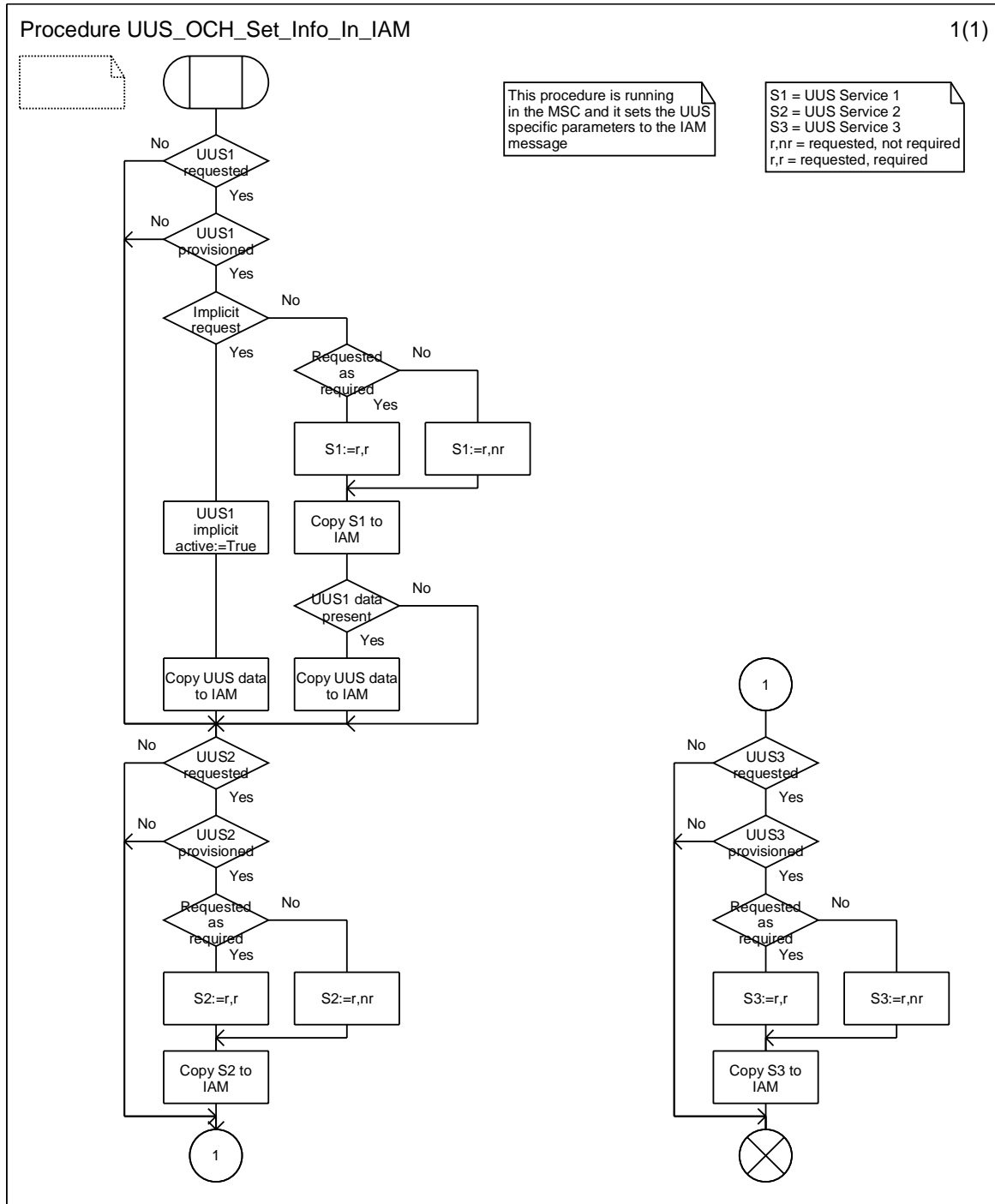
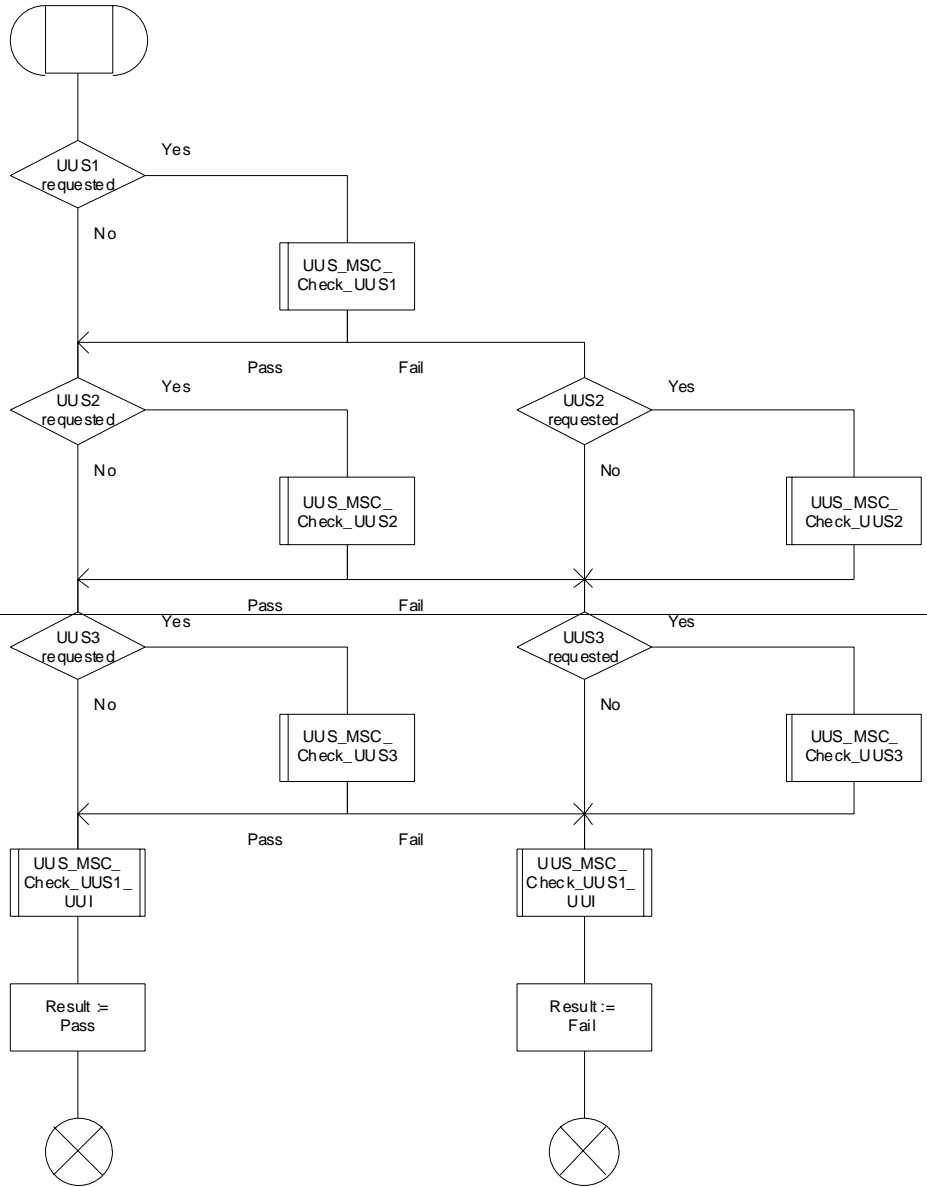

Figure 9.1.1.2: Procedure UUS_OCH_Set_Info_In_IAM

Procedure UUS_OCH_Set_Alert_And_Connect_Param

1(1)

This procedure is running in the MSC and it sets the UUS parameters to the call control messages directed back to the initiating MS



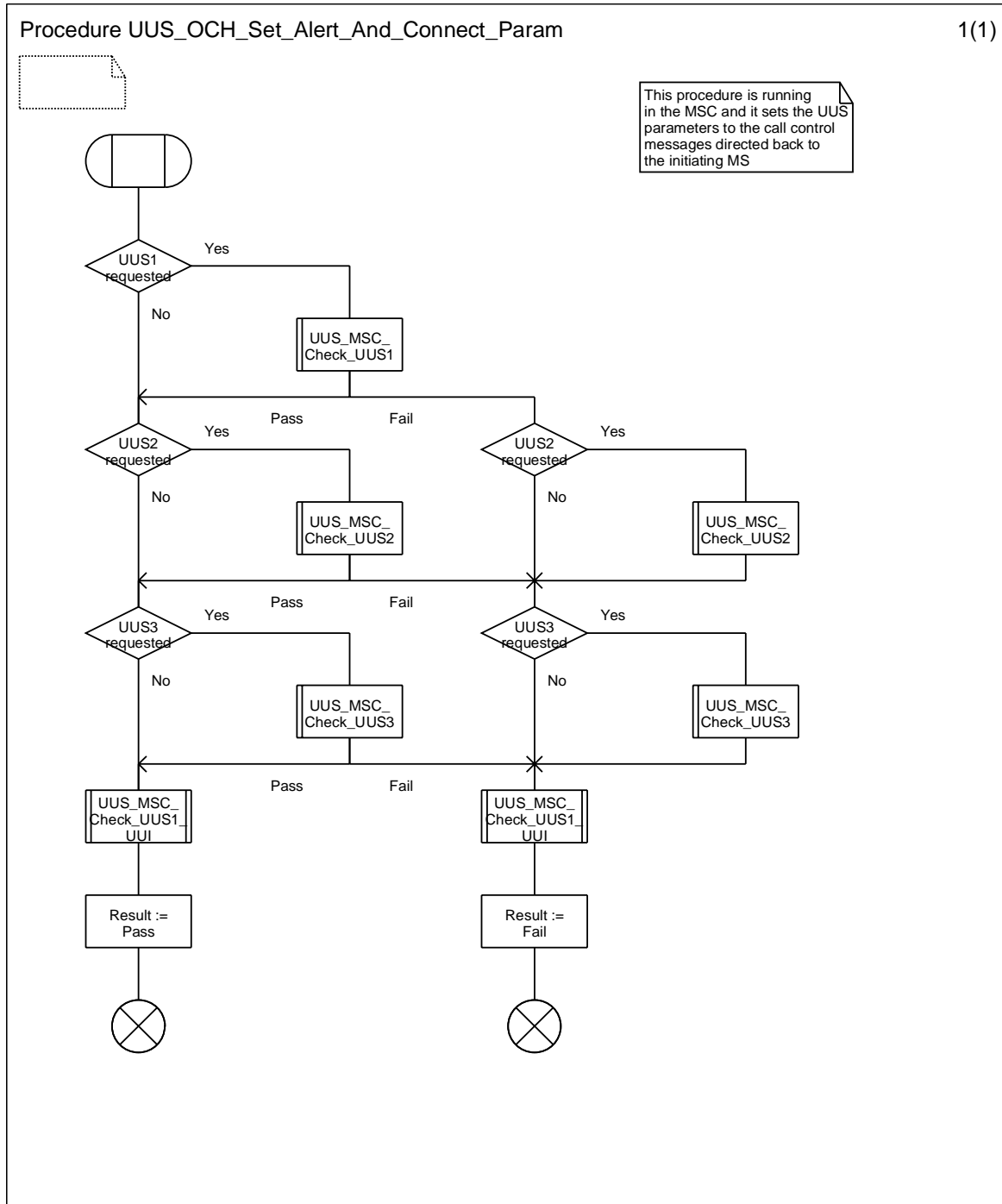

Figure 9.1.1.3: Procedure UUS_OCH_Set_Alert_And_Connect_Param

9.1.2 Procedures in VLR

Figure 9.1.2.1 Procedure UUS_OCH_Check_Provision.

This procedure is called in the VLR during subscription checks for an outgoing call. It sets requested UUS service provision information in Complete call message. If any of the UUS services is requested as required and the service is not provided to the subscription, the check will fail and the call will be cleared.

Procedure UUS_OCH_Check_Provision

1(1)



This procedure is running in the VLR and it does the UUS specific provisioning checks

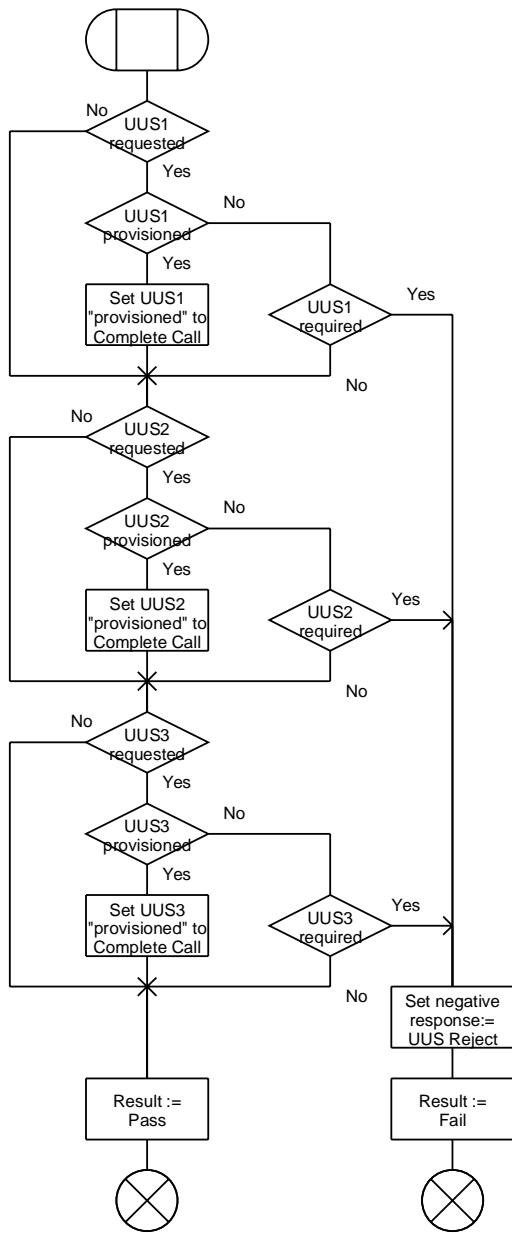

Figure 9.1.2.1: Procedure UUS_OCH_Check_Provision

9.2 Terminating network processes

9.2.1 Procedures in GMSC

Figure 9.2.1.1 Procedure UUS_GMSC_Check_Forwarding.

This procedure is called when Resume Call Handling message is received from the remote MSC. If the message contains UUS related information, that is copied to the subsequent IAM message.

Procedure UUS_GMSC_Check_Forwarding

1(1)

This procedure is running in the GMSC and it check whether UUS specific data shall be forwarded in the optimal routing case

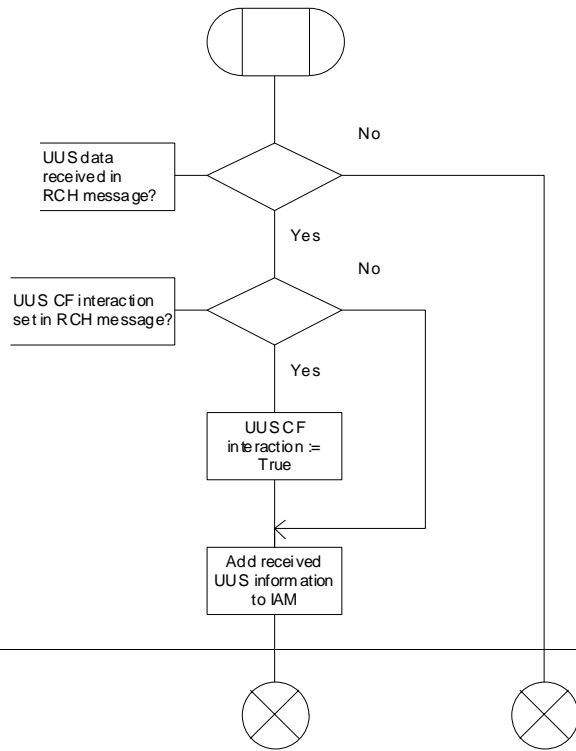

Procedure UUS_GMSC_Check_Forwarding

1(1)



This procedure is running in the GMSC and it checks whether UUS specific data shall be forwarded in the optimal routing case

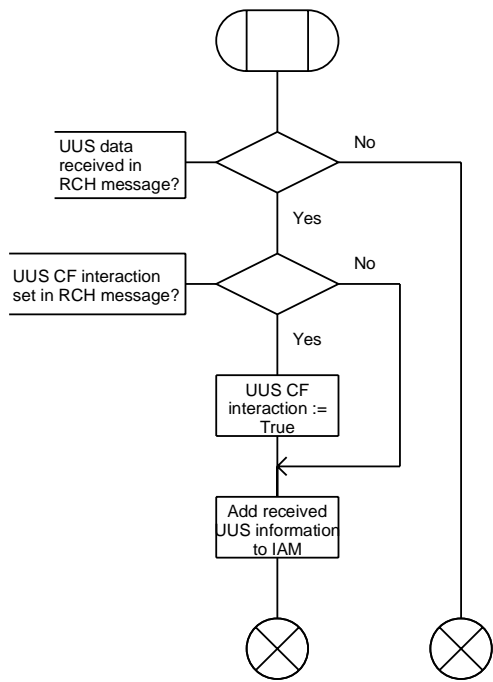

Figure 9.2.1.1: Procedure UUS_GMSC_Check_Forwarding

9.2.2 Procedures in MSC

Figure 9.2.2.1 Procedure UUS_ICH_Check_Support.

This procedure is called after Alerting/Connect message is received from B-subscriber. It checks whether UUS service is possible and if not whether the call setup can be continued.

Figure 9.2.2.2 Procedure UUS_ICH_Check_Forwarding.

This procedure is called when no reply is received from B-subscriber. It checks whether call forwarding is allowed from UUS service point of view.

Figure 9.2.2.3 Procedure UUS_ICH_Handle_LCF.

This procedure is used to add UUS information to Resume Call Handling message when Optimal Routing late call forwarding is supported.

Figure 9.2.2.4 Procedure UUS_ICH_Set_Info_In_IAM.

This procedure is used to add UUS specific information to forwarded call IAM message.

Figure 9.2.2.5 Procedure UUS_ICH_UUS1_Implicit_Active.

This procedure is used to set UUS1 implicit service active at the remote MSC when only UUI for service 1 is received.

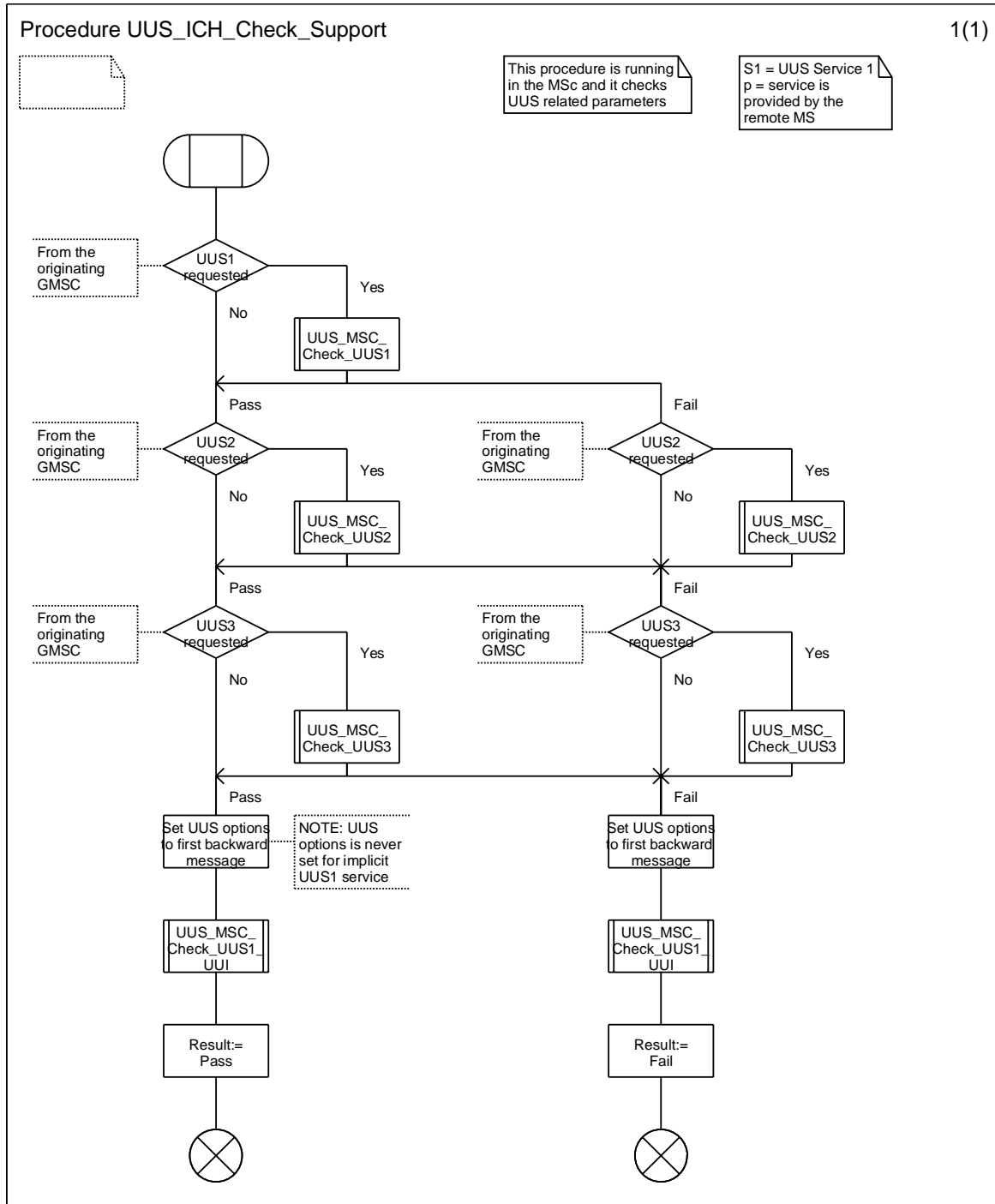
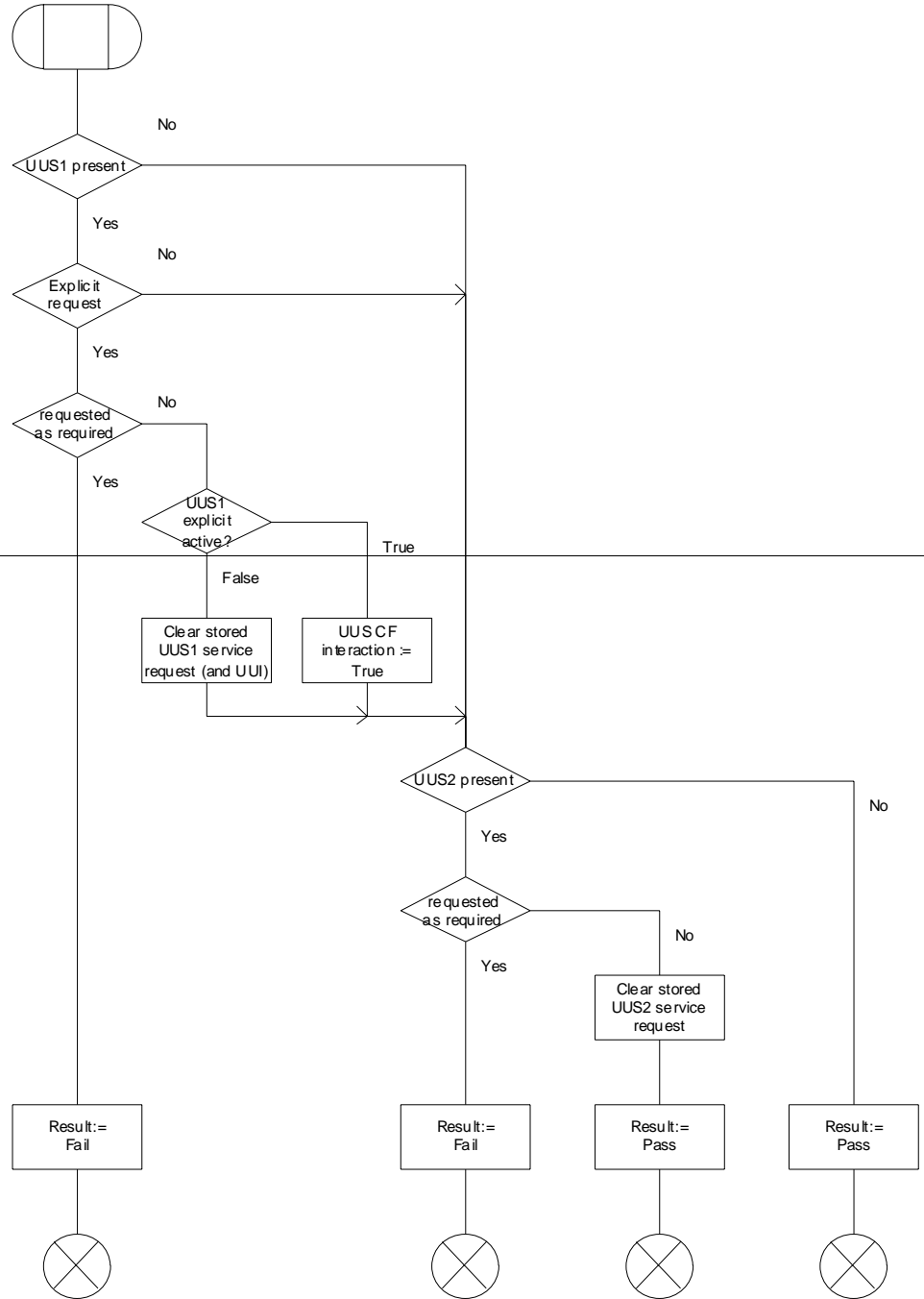

Figure 9.2.2.1: Procedure UUS_ICH_Check_Support

Procedure UUS_ICH_Check_Forwarding

1(1)

This procedure is running in the MSC and it checks whether UUS can be forwarded and if call forwarding is allowed.
NOTE: UUS CF interaction flag is set if UUS1 service request response was sent to the serving nw and CF happens after that



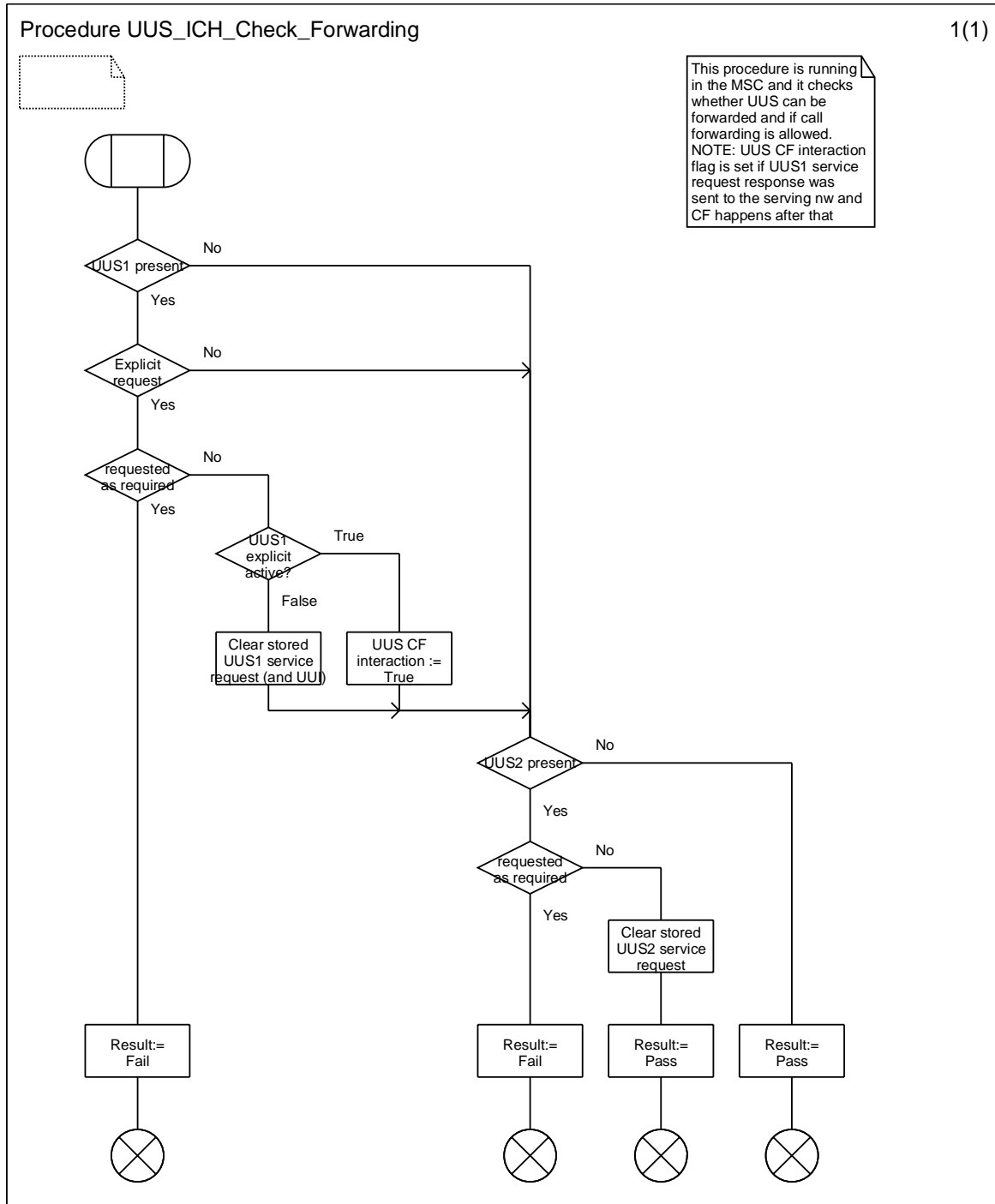
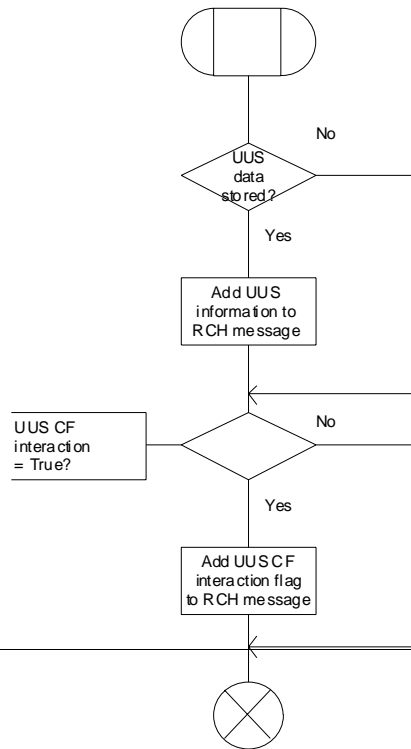

Figure 9.2.2.2: Procedure UUS_ICH_Check_Forwarding

Procedure UUS_ICH_Handle_LCF

1(1)

This procedure is running in the MSC and it checks whether UUS will be forwarded in the optimal routing case



Procedure UUS_ICH_Handle_LCF

1(1)



This procedure is running in the MSC and it checks whether UUS will be forwarded in the optimal routing case

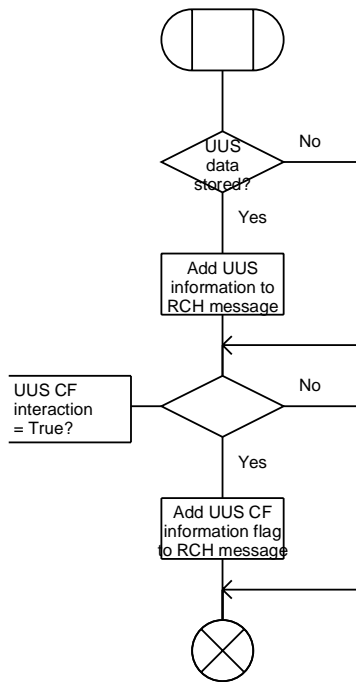
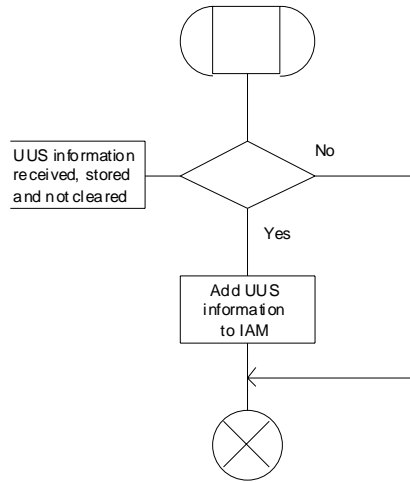

Figure 9.2.2.3: Procedure UUS_ICH_Handle_LCF

Procedure UUS_ICH_Set_Info_In_IAM

1(1)

This procedure is running in the MSC and it checks whether UUS will be added to the IAM message in the call forwarding case



Procedure UUS_ICH_Set_Info_In_IAM

1(1)



This procedure is running in the MSC and it checks whether UUS will be added to the IAM message in the call forwarding case

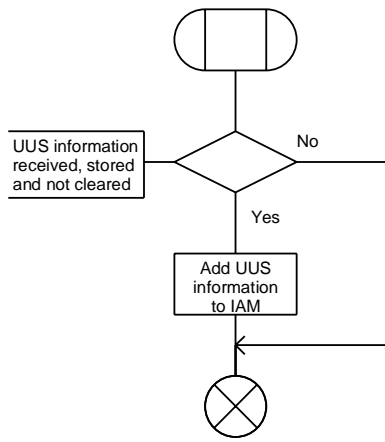
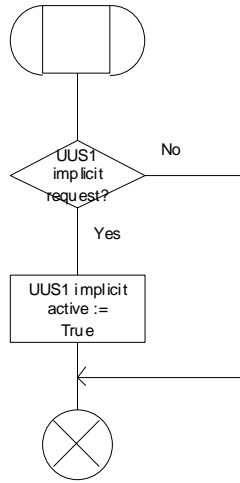

Figure 9.2.2.4: Procedure UUS_ICH_Set_Info_In_IAM

Procedure UUS_ICH_UUS1_Implicit_Active

1(1)

This procedure is running in the MSC and it sets the implicit UUS1 active when UUI is send



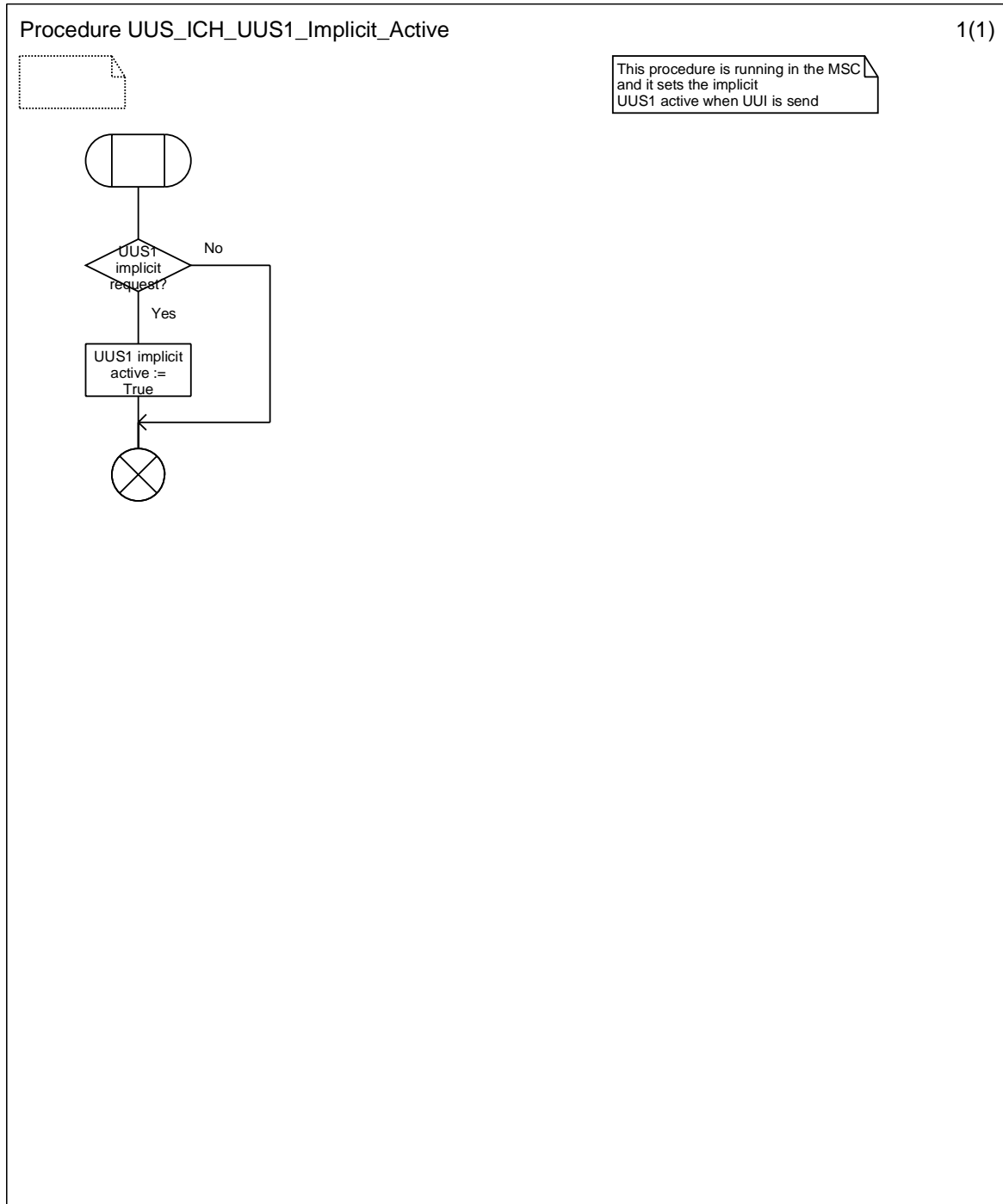

Figure 9.2.2.5: Procedure UUS_ICH_UUS1_Implicit_Active

9.3 Procedures common in serving and remote networks

Figure 9.3.1 Procedure UUS_MSC_Check_UUS1_UUI.

This procedure is used to check whether it is allowed to pass UUI for UUS1 from MS to network or vice versa.

Figure 9.3.2 Procedure UUS_MSC_Check_UUS2_UUI_to_MS.

This procedure is used to check whether it is allowed to pass User-To-User messages for UUS2 from network to MS.

Figure 9.3.3 Procedure UUS_MSC_Check_UUS2_UUI_to_NW.

This procedure is used to check whether it is allowed to pass User-To-User messages for UUS2 from MS to network.

Figure 9.3.4 Procedure UUS_MSC_Check_UUS3_UUI_to_MS.

This procedure is used to check whether it is allowed to pass User-To-User messages for UUS3 from network to MS.

Figure 9.3.5 Procedure UUS_MSC_Check_UUS3_UUI_to_NW.

This procedure is used to check whether it is allowed to pass User-To-User messages for UUS3 from MS to network.

Figure 9.3.6 Procedure UUS_MSC_Clear_UUS.

This procedure is used to handle the call forwarding interaction with UUS when call control messages are received from the forwarded-to NW.

Figure 9.3.7 Macrodefinition UUS_MSC_Check_UUS1.

Macro used in procedures UUS_OCH_Set_Alert_And_Connect_Param and UUS_ICH_Check_Support. It checks whether UUS service 1 is supported.

Figure 9.3.8 Macrodefinition UUS_MSC_Check_UUS2.

Macro used in procedures UUS_OCH_Set_Alert_And_Connect_Param and UUS_ICH_Check_Support. It checks whether UUS service 2 is supported.

Figure 9.3.9 Macrodefinition UUS_MSC_Check_UUS3.

Macro used in procedures UUS_OCH_Set_Alert_And_Connect_Param and UUS_ICH_Check_Support. It checks whether UUS service 3 is supported.

Procedure UUS_MSC_Check_UUS1_UUI

1(1)

This procedure is running in the MSC and it checks whether UUI can be passed over

Signals to/from the left are to/from the BSS; signals to/from the right are to/from the destination exchange unless otherwise marked.

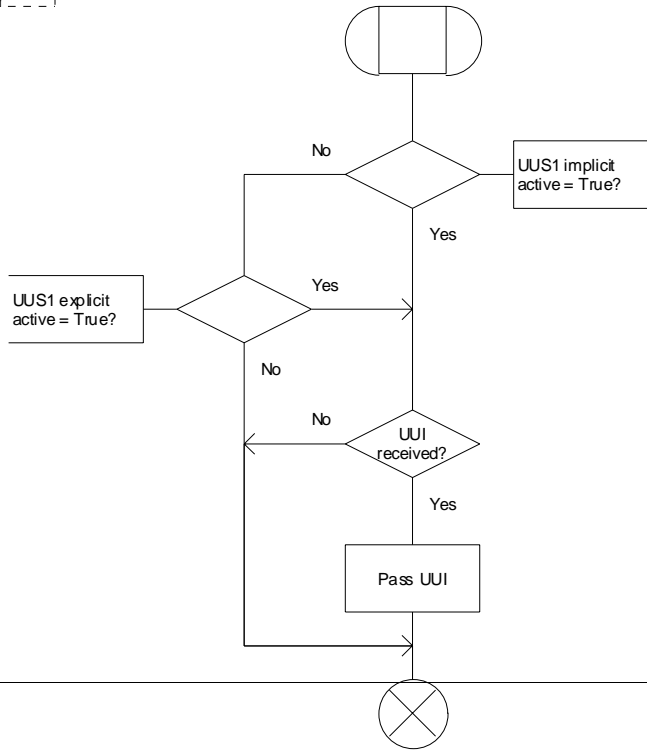

Procedure UUS_MSC_Check_UUS1_UUI

1(1)



This procedure is running in the MSC and it checks whether UUI can be passed over

Signals to/from the left are to/from the BSS; signals to/from the right are to/from the destination exchange unless otherwise marked.

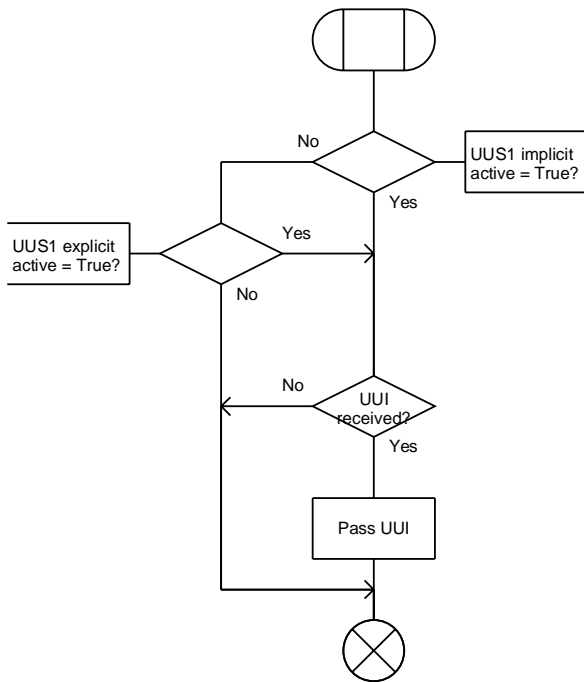

Figure 9.3.1: Procedure UUS_MSC_Check_UUS1_UUI

Procedure UUS_MSC_Check_UUS2_UUI_to_MS

1(1)

This procedure is running in the MSC and it checks whether UUI can be passed over

Signals to/from the left are to/from the BSS; signals to/from the right are to/from the destination exchange unless otherwise marked.

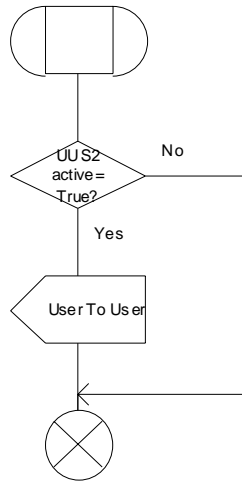

Procedure UUS_MSC_Check_UUS2_UI_to_MS

1(1)



This procedure is running in the MSC and it checks whether UUI can be passed over

Signals to/from the left are to/from the BSS; signals to/from the right are to/from the destination exchange unless otherwise marked.

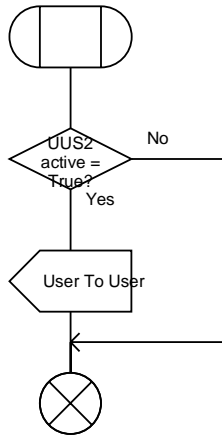

Figure 9.3.2: Procedure UUS_MSC_Check_UUS2_UI_to_MS

Procedure UUS_MSC_Check_UUS2_UUI_to_NW

1(1)

This procedure is running in the MSC and it checks whether UUI can be passed over. In addition it handles UUS2 flow control

Signals to/from the left are to/from the BSS; signals to/from the right are to/from the destination exchange unless otherwise marked.

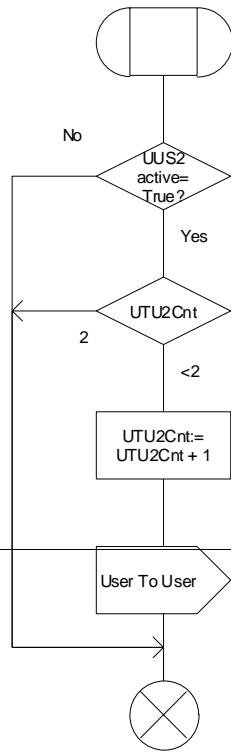

Procedure UUS_MSC_Check_UUS2_UII_to_NW

1(1)



This procedure is running in the MSC and it checks whether UUI can be passed over. In addition it handles UUS2 flow control

Signals to/from the left are to/from the BSS; signals to/from the right are to/from the destination exchange unless otherwise marked.

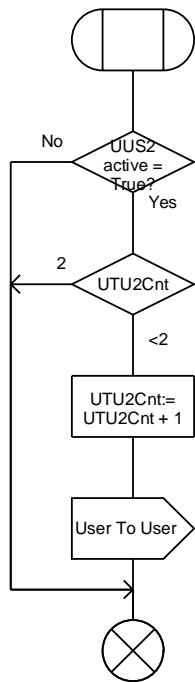

Figure 9.3.3: Procedure UUS_MSC_Check_UUS2_UII_to_NW

Procedure UUS_MSC_Check_UUS3_UUI_to_MS

1(1)

This procedure is running in the MSC and it checks whether UUI can be passed over.

Signals to/from the left are to/from the BSS; signals to/from the right are to/from the destination exchange unless otherwise marked.

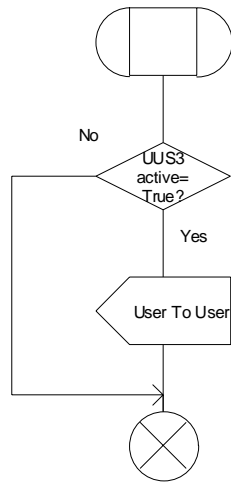

Procedure UUS_MSC_Check_UUS3_UI_to_MS

1(1)



This procedure is running in the MSC and it checks whether UUI can be passed over

Signals to/from the left are to/from the BSS; signals to/from the right are to/from the destination exchange unless otherwise marked.

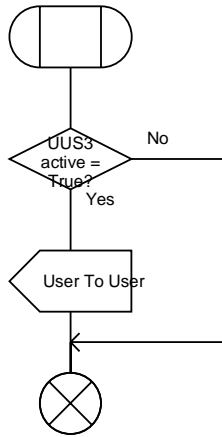

Figure 9.3.4: Procedure UUS_MSC_Check_UUS3_UI_to_MS

Procedure UUS_MSC_Check_UUS3_UUI_to_NW

1(1)

This procedure is running in the MSC and it checks whether UUI can be passed over. In addition it handles UUS3 flow control

Signals to/from the left are to/from the BSS; signals to/from the right are to/from the destination exchange unless otherwise marked.

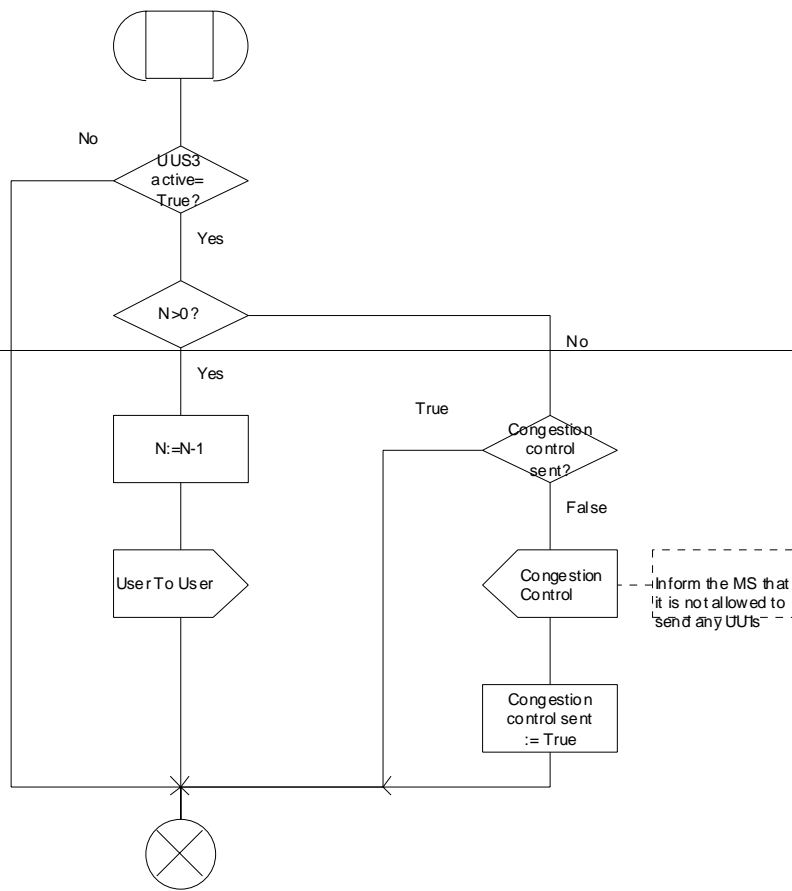

Procedure UUS_MSC_Check_UUS3_UII_to_NW

1(1)



This procedure is running in the MSC and it checks whether UUI can be passed over. In addition it handles UUS3 flow control

Signals to/from the left are to/from the BSS; signals to/from the right are to/from the destination exchange unless otherwise marked.

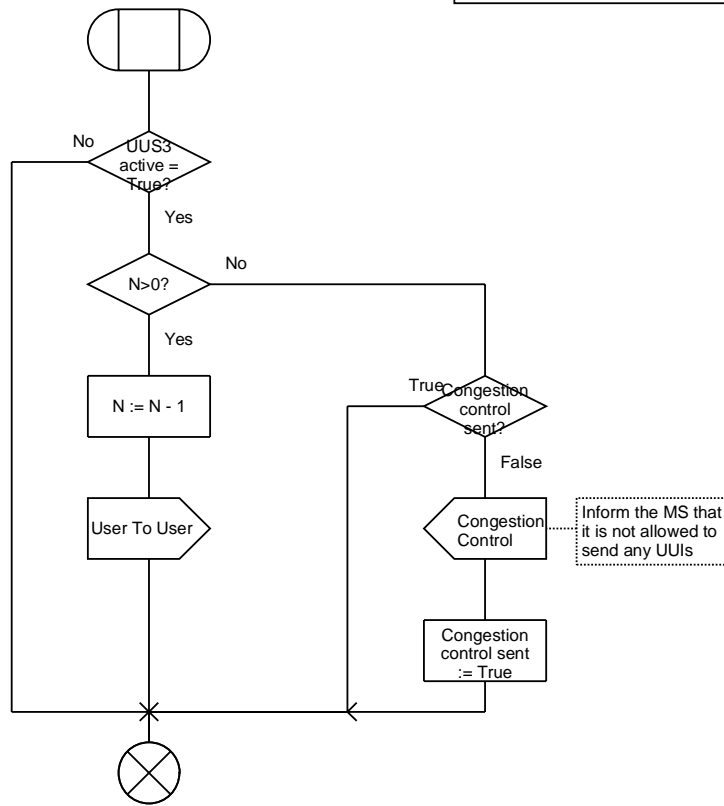

Inform the MS that it is not allowed to send any UUIs

Figure 9.3.5: Procedure UUS_MSC_Check_UUS3_UII_to_NW

Procedure UUS_MSC_Clear_UUS

1(1)

This procedure is running in the MSC and it handles CFNRy and UUS interaction when the MSC is receiving call control messages from forwarded to NW.

S1 = UUS1 Service response

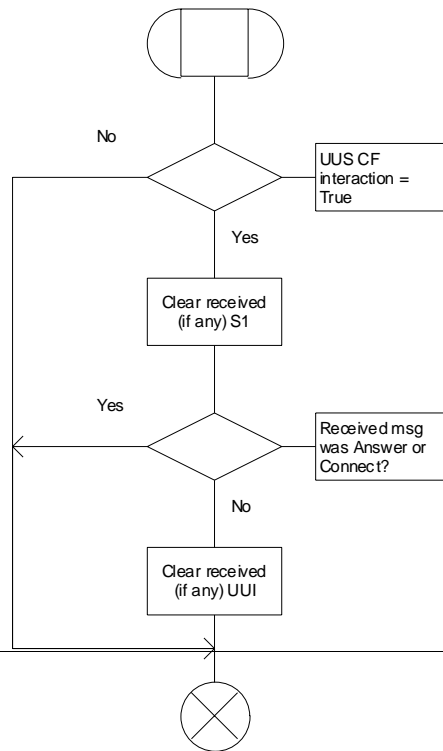

Procedure UUS_MSC_Clear_UUS

1(1)



This procedure is running in the MSC and it handles CFNRy and UUS interaction when the MSC is receiving call control messages from forwarded-to NW.

S1 = UUS1 Service response

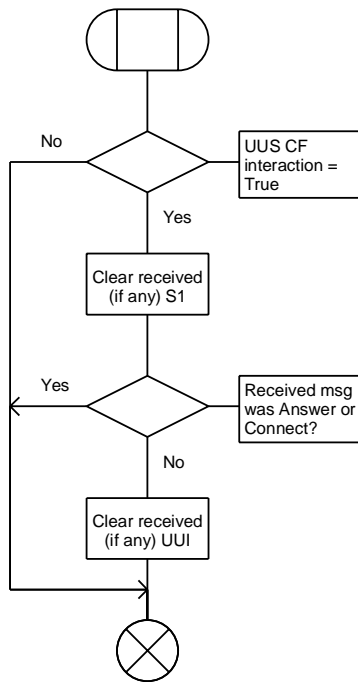
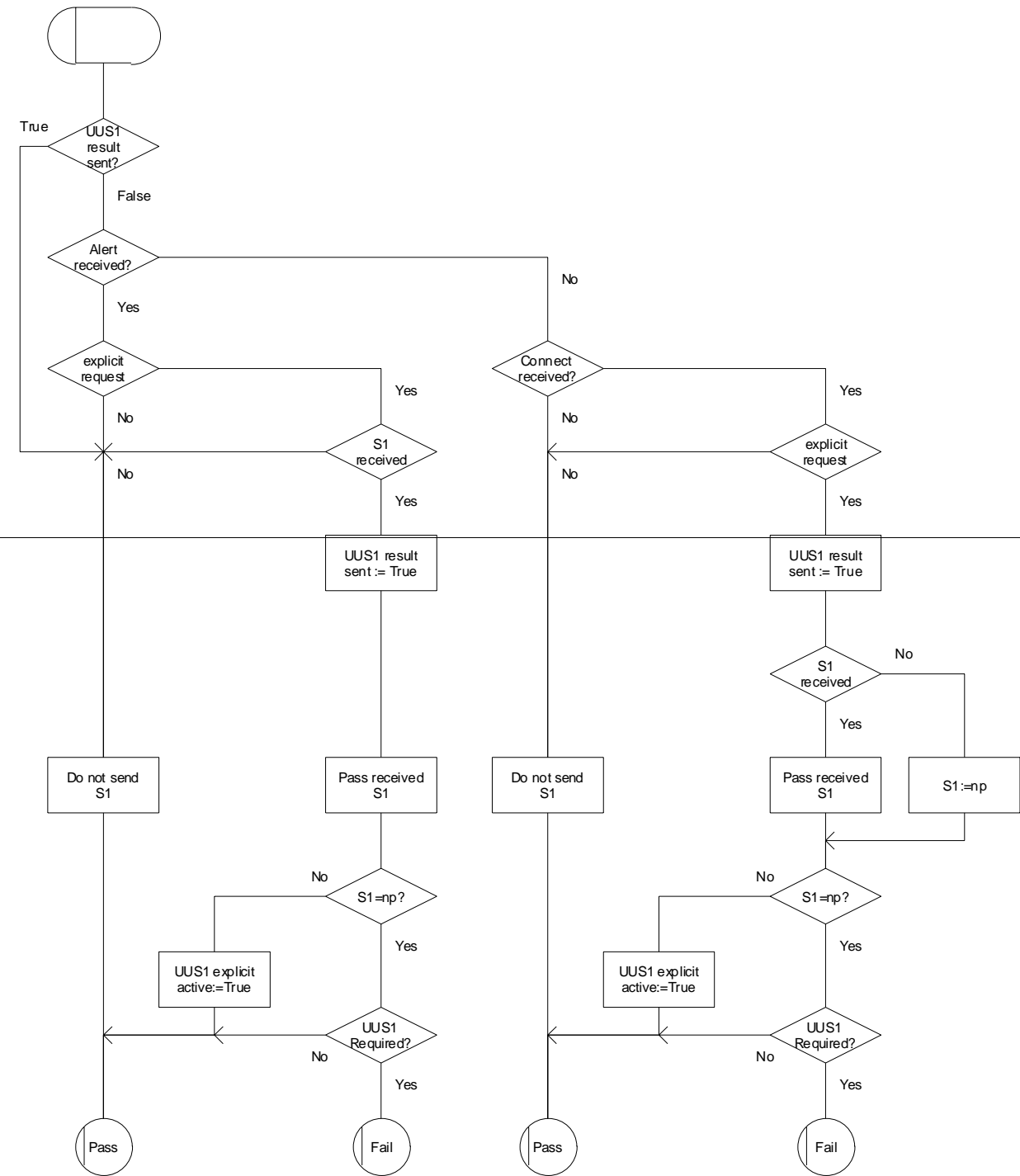

Figure 9.3.6: Procedure UUS_MSC_Clear_UUS

Macrodefinition UUS_MSC_Check_UUS1

1(1)

np = service is not provided by network or remote end



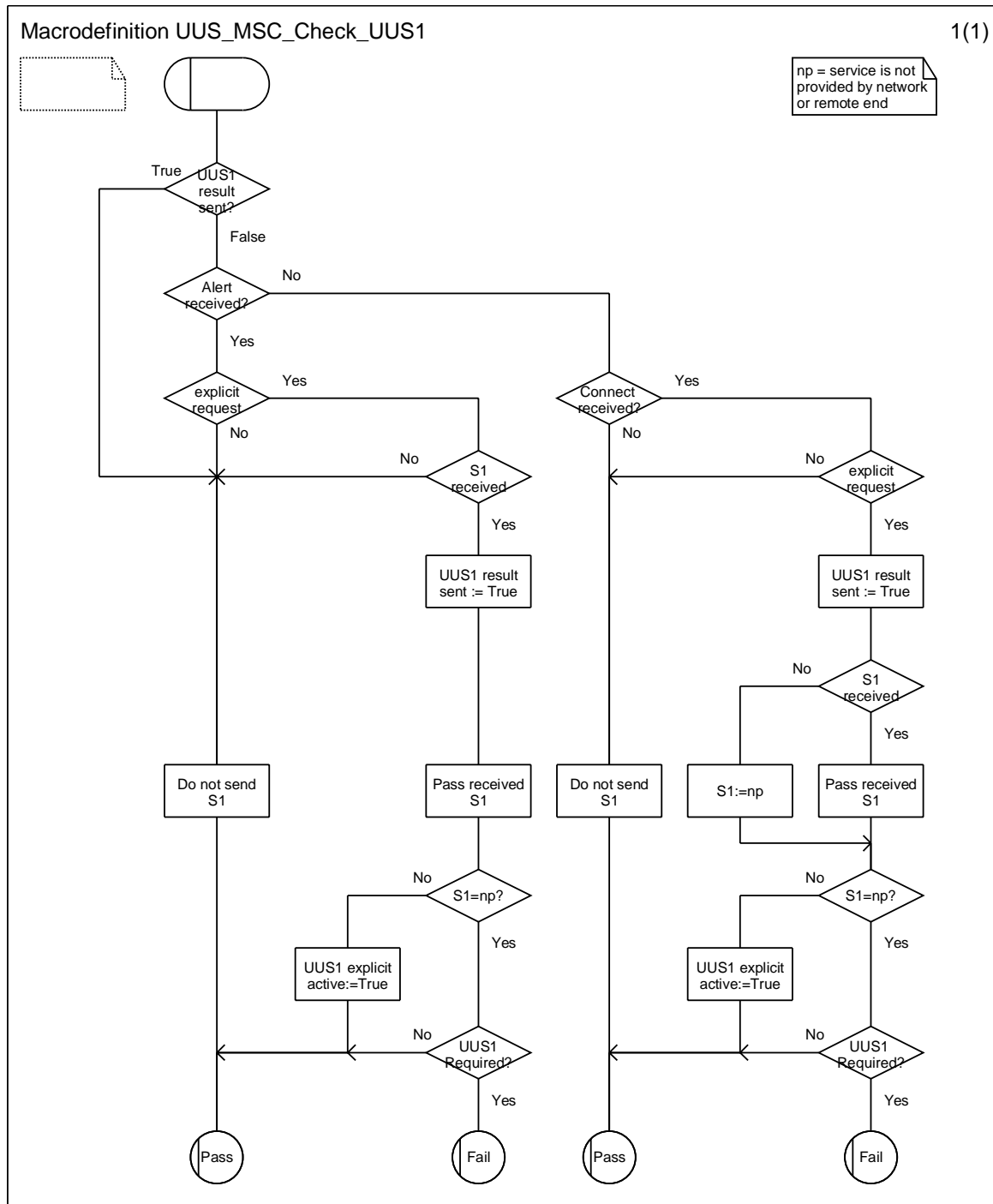

Figure 9.3.7: Macrodefinition UUS_MSC_Check_UUS1

Macrodefinition UUS_MSC_Check_UUS2

1(1)



np = service is not provided by network or remote end

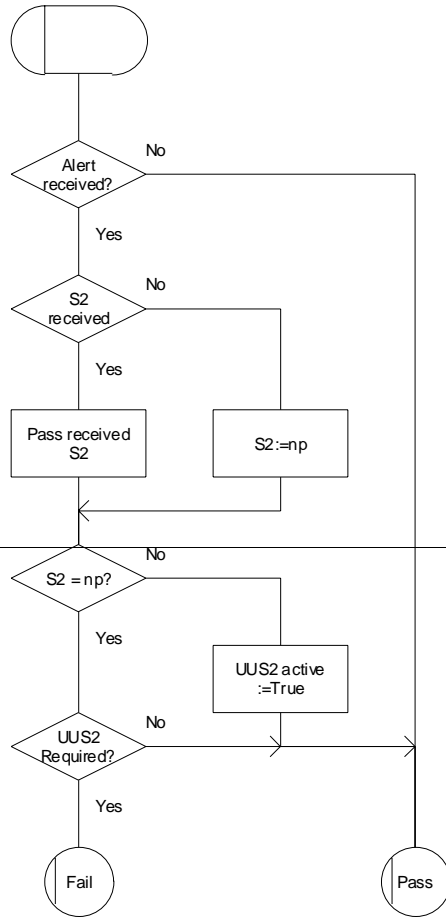

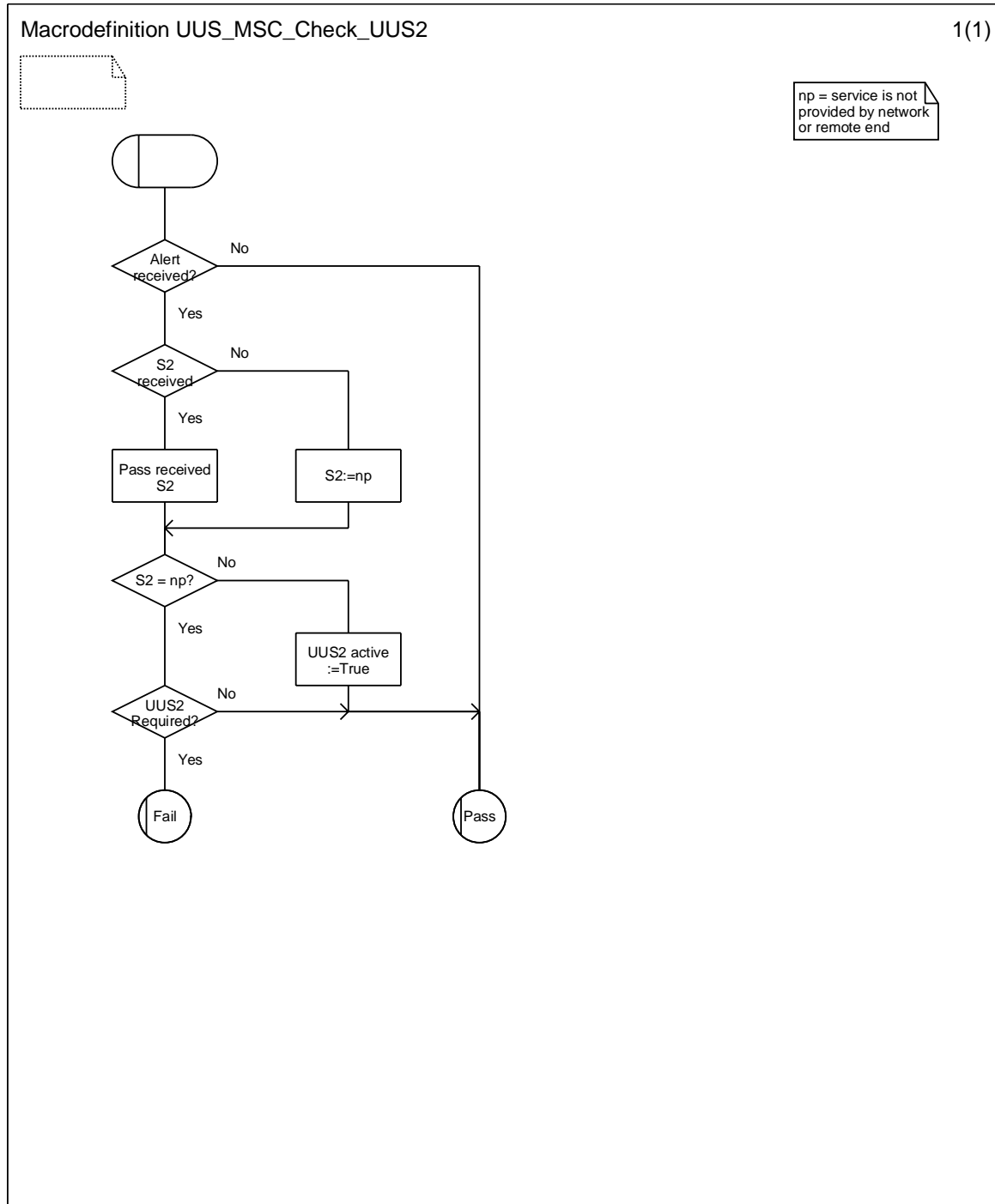

Figure 9.3.8: Macrodefinition UUS_MSC_Check_UUS2

Macrodefinition UUS_MSC_Check_UUS3

1(1)



np = service is not provided by network or remote end

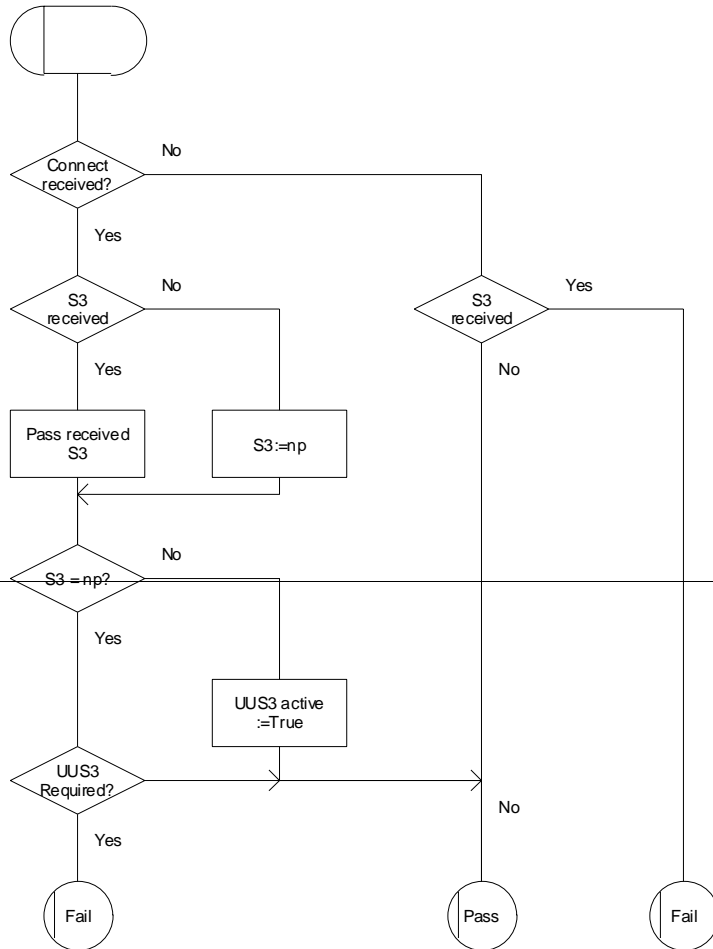

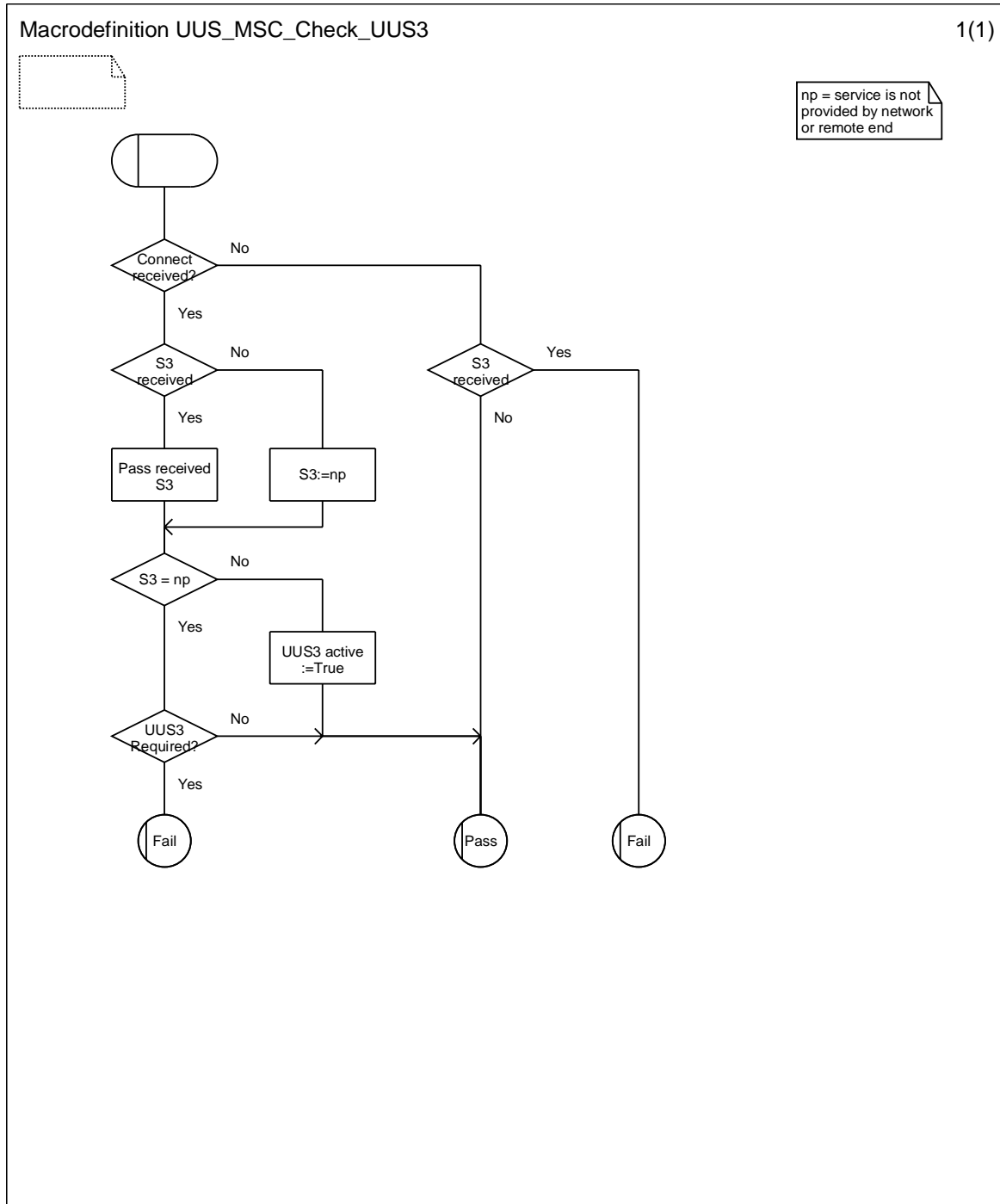

Figure 9.3.9: Macrodefinition UUS_MSC_Check_UUS3

9.4 Processes used during Active Call

There are different processes running for UUS3 during active call in serving and remote network. However, this differentiation does not implicitly mean that call originator's network is serving network. The differentiation is based on which party initiates the UUS3 service. Thus, serving network process shall be used on initiator's side and remote network process on the opposite end.

9.4.1 Process and procedures in serving MSC

Figure 9.4.1.1 Process Serving_MSC_Handle_UUS_In_Active_Call

This process is used to check UUS3 activation during active call, handle UUS3 flow control and interaction with ECT supplementary service. The process starts during the call setup and checks the content of the Connect message in order to start the UUS3 flow control correctly. If the UUS3 is not activated the process stays in the Idle state and waits UUS3 activation request from the MS.

Figure 9.4.1.2 Procedure UUS_MSC_Check_UUS3_Activation

This procedure is used to handle the dialogue towards the serving VLR when provisioning check is done.

Process Serving_MSC_Handle_UUS_In_Active_Call

1(4)

This process is running in the serving MSC. It handles UUS3 during the active call

Signals b/from the left are to/from the BSS; signals to/from the right are b/from the destination/originating exchange unless otherwise marked.

p = provided i.e. UUS3 service is provided
np = not provided i.e. UUS3 service is not provided

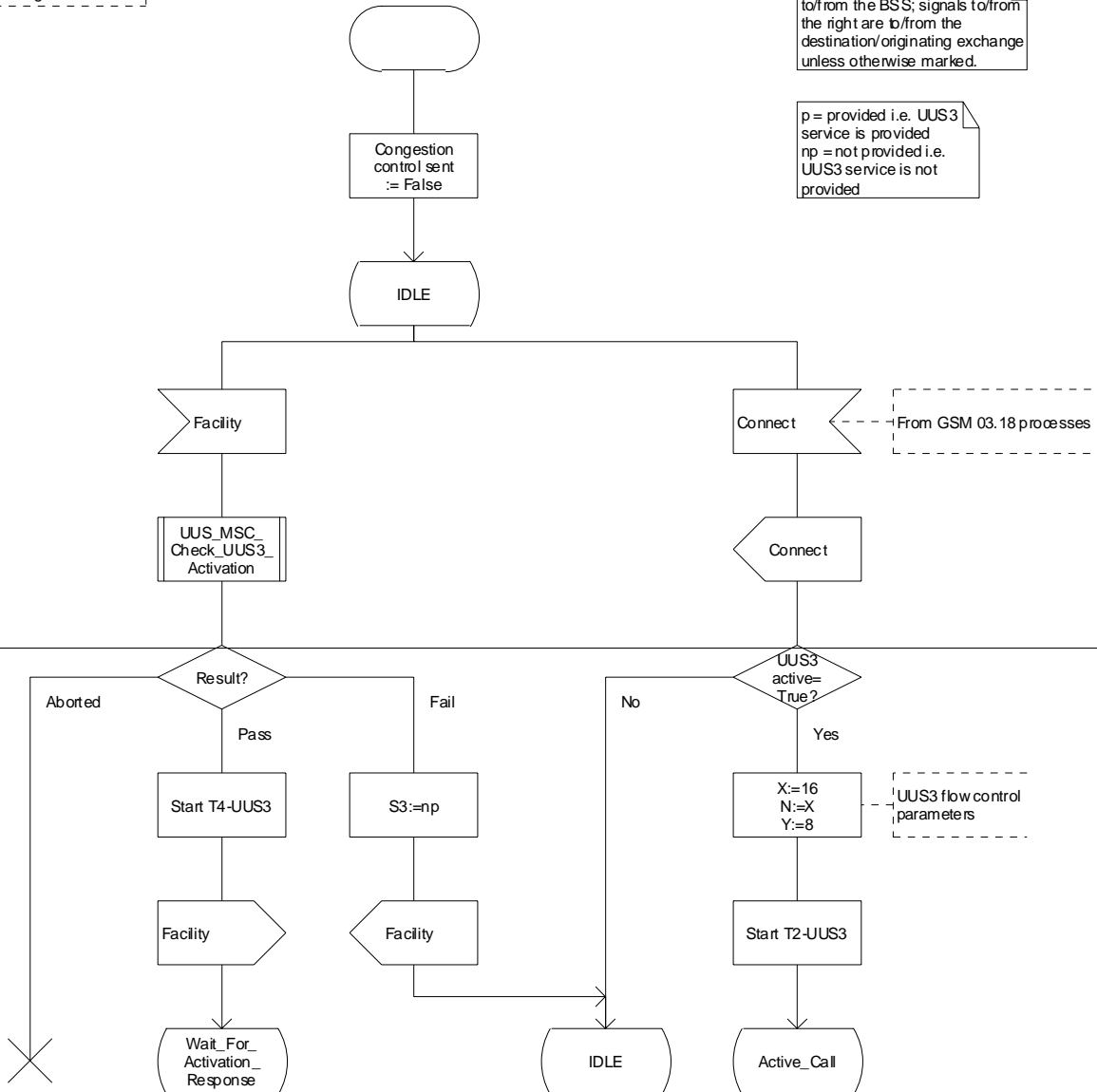

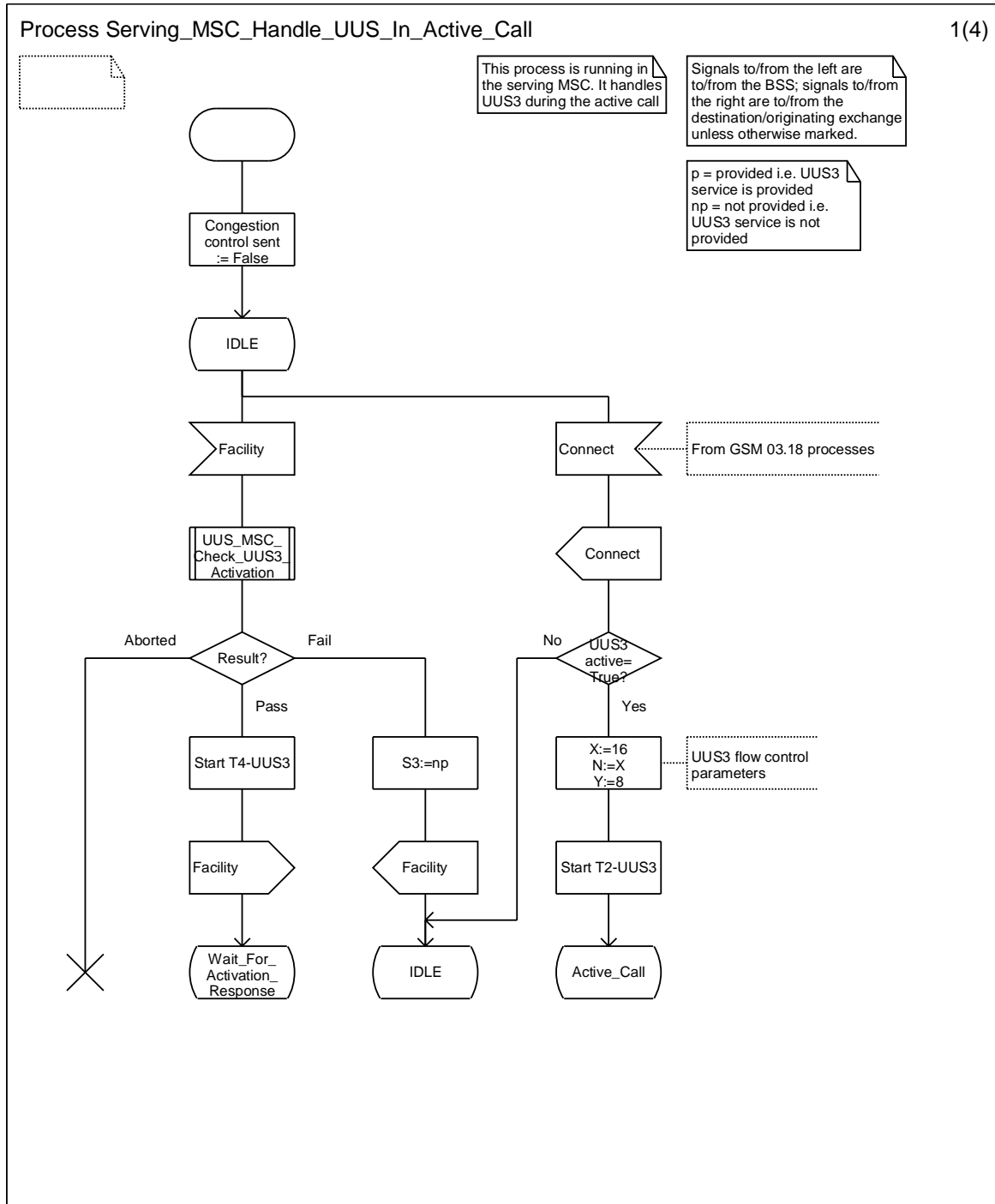

Figure 9.4.1.1: Process Serving_MSC_Handle_UUS_In_Active_Call (sheet 1)

Process Serving_MSC_Hande_UUS_In_Active_Call

2(4)

This process is running in the serving MSC. It handles UUS3 during the active call.

Signals to/from the left are to/from the BSS; signals to/from the right are to/from the destination/originating exchange unless otherwise marked.

p = provided i.e. UUS3 service is provided
 np = not provided i.e. UUS3 service is not provided

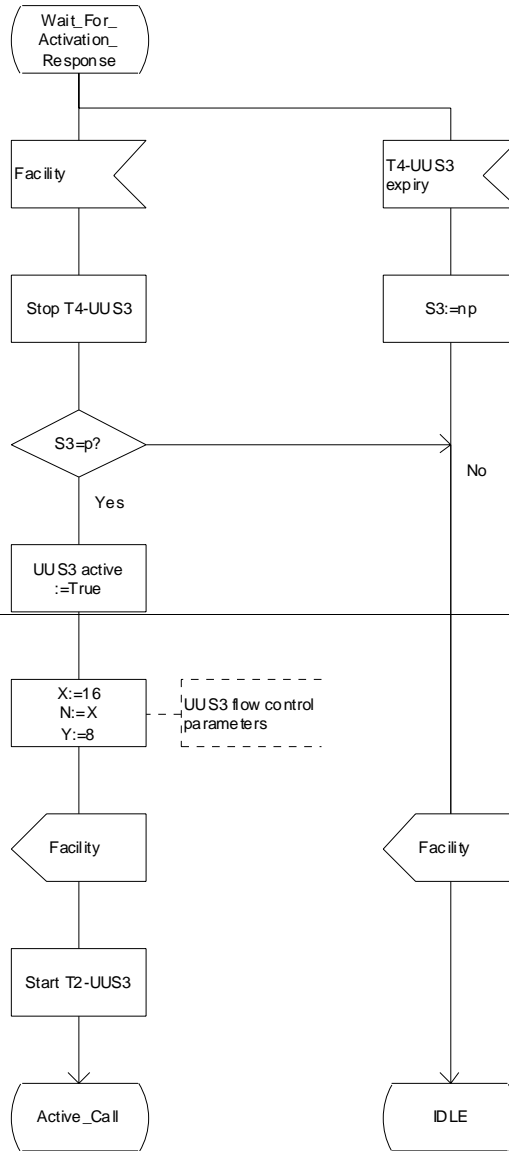

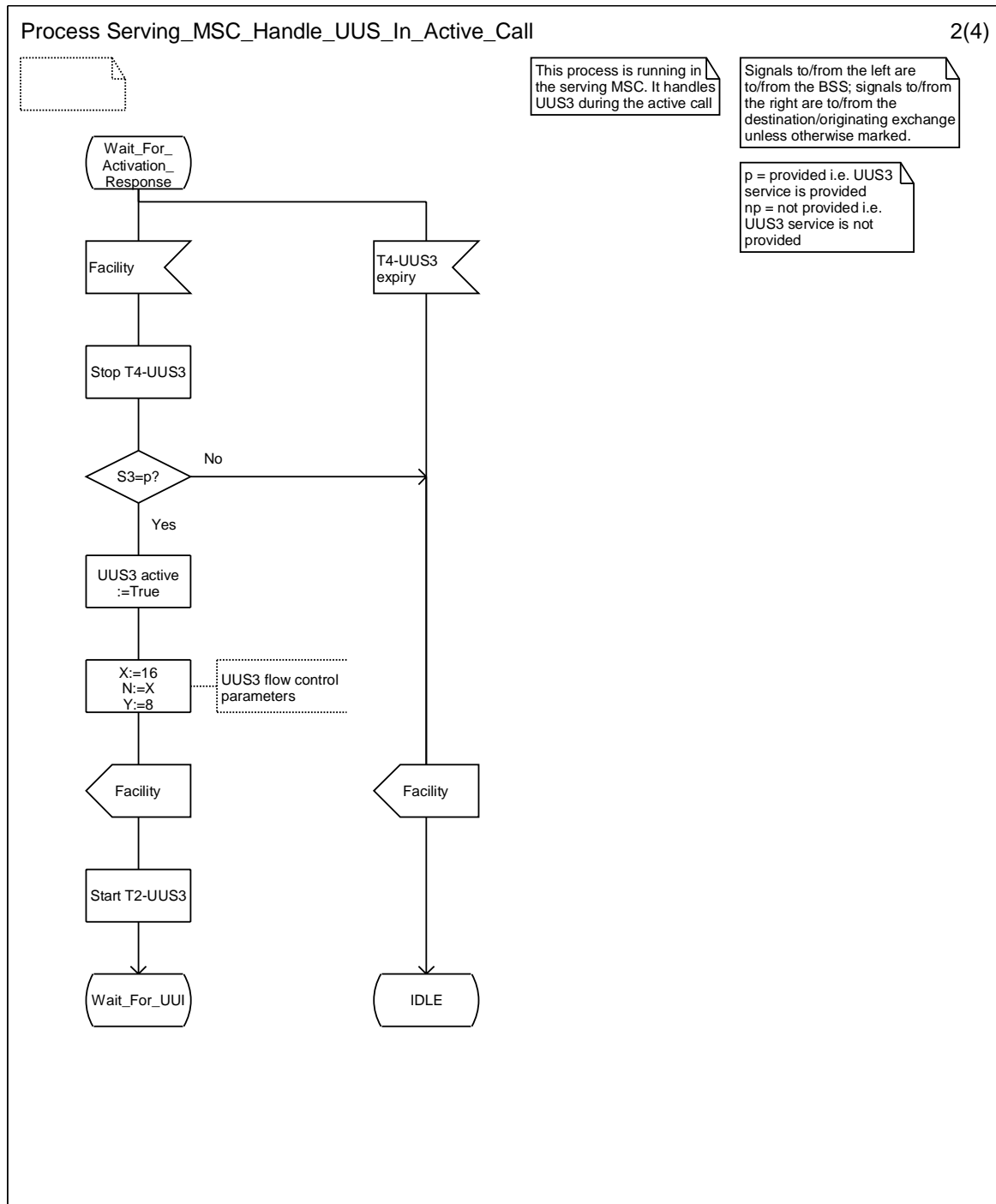

Figure 9.4.1.1: Process Serving_MSC_Handle_UUS_In_Active_Call (sheet 2)

Process Serving_MSC_Handle_UUS_In_Active_Call

3(4)



This process is running in the serving MSC. It handles UUS3 during the active call

Signals to/from the left are to/from the BSS; signals to/from the right are to/from the destination/originating exchange unless otherwise marked.

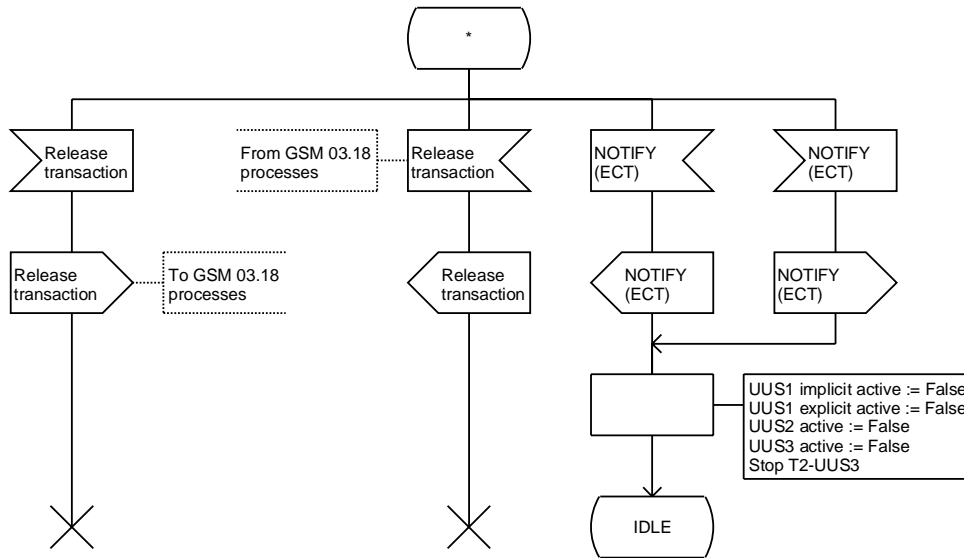

Figure 9.4.1.1: Process Serving_MSC_Handle_UUS_In_Active_Call (sheet 3)

Process Serving_MSC_Handle_UUS_In_Active_Call

4(4)

This process is running in the serving MSC. It handles UUS3 during the active call.

Signals to/from the left are to/from the BSS; signals to/from the right are to/from the destination/originating exchange unless otherwise marked.

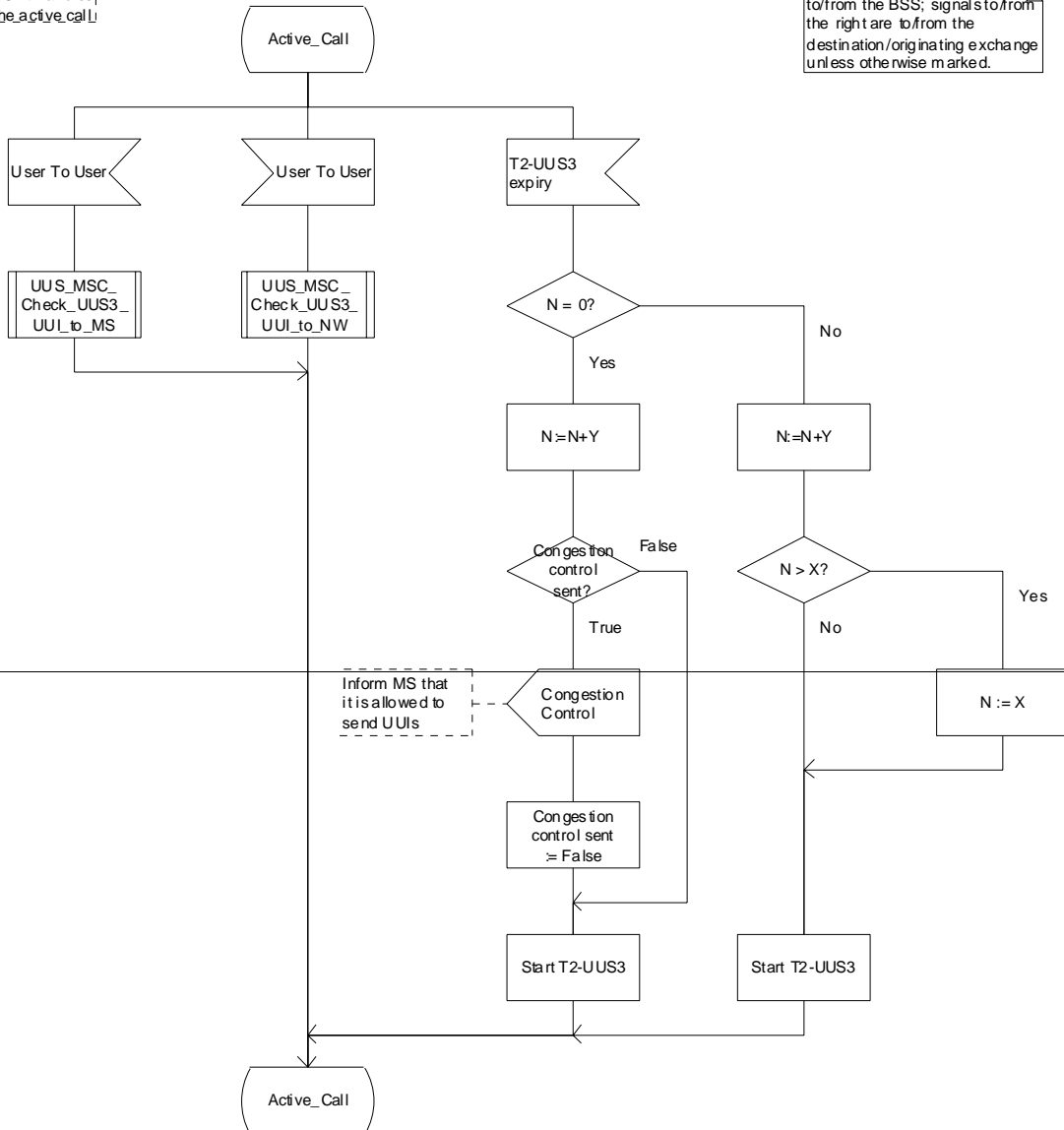

Inform MS that it is allowed to send UUIs

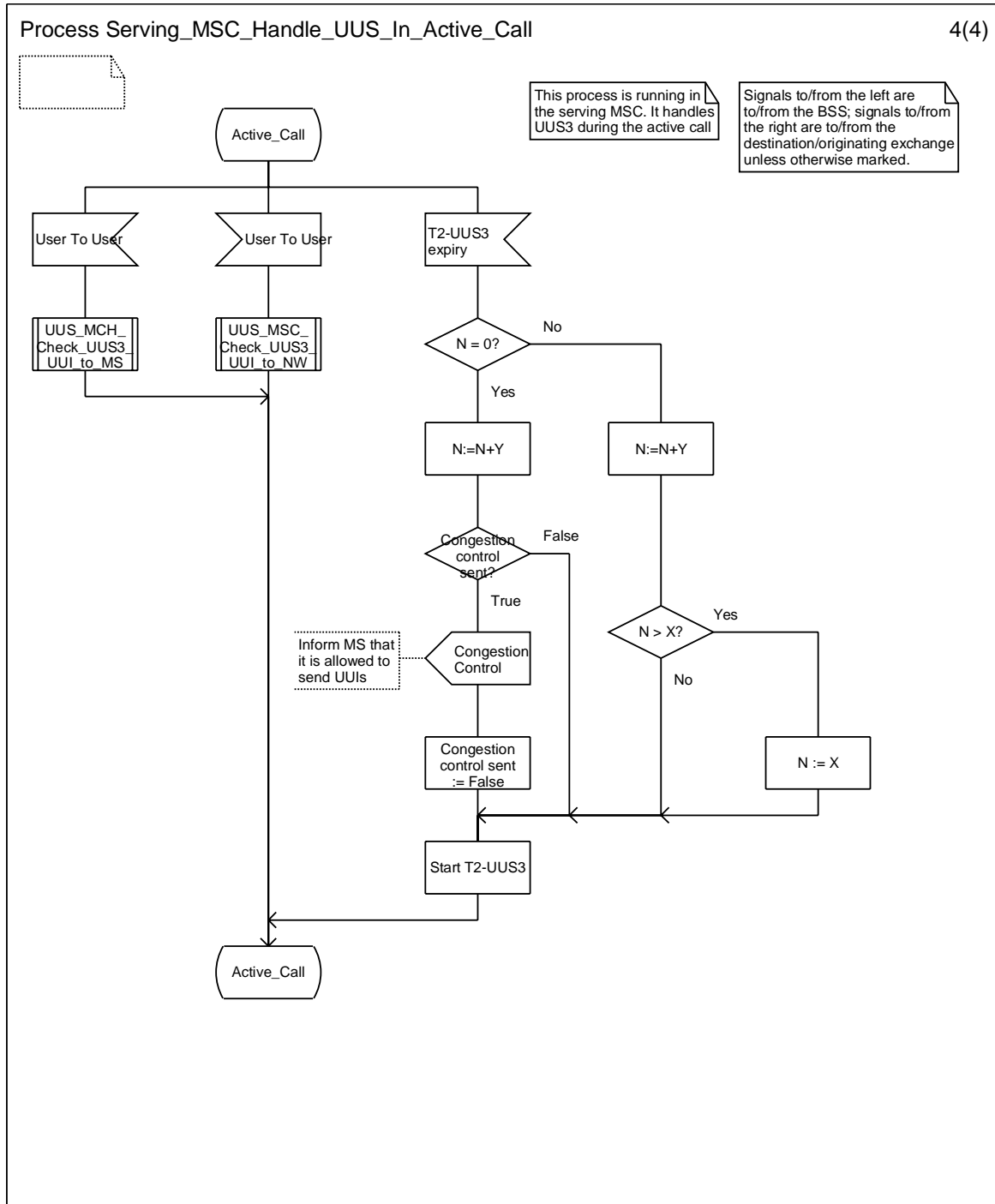

Figure 9.4.1.1: Process Serving_MSC_Handle_UUS_In_Active_Call (sheet 4)

Procedure UUS_MSC_Check_UUS3_Activation

1(1)

This procedure is running in the MSC and it checks UUS3 activation during active call

Signals to/from the right are to/from the VLR unless otherwise marked.

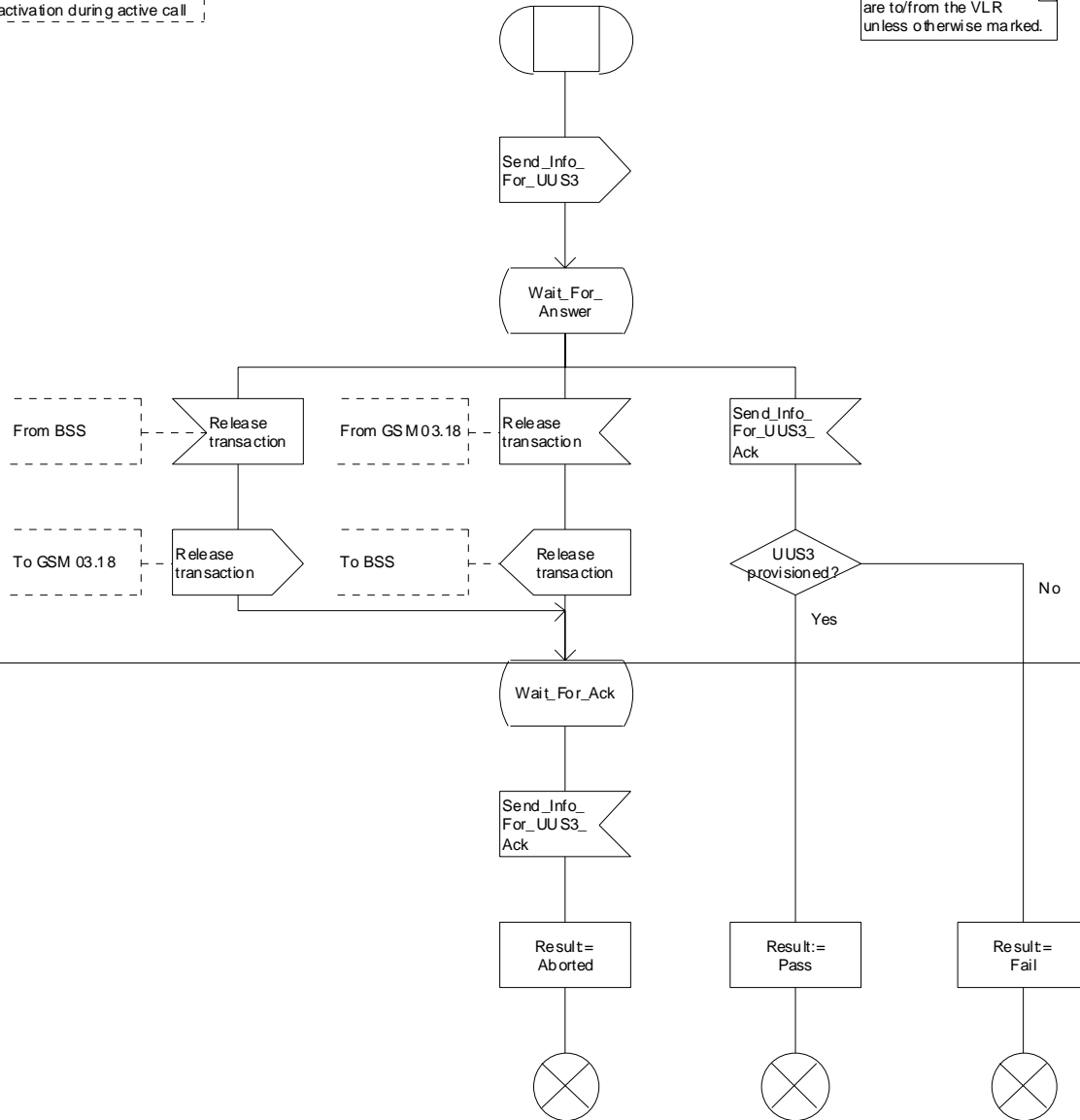

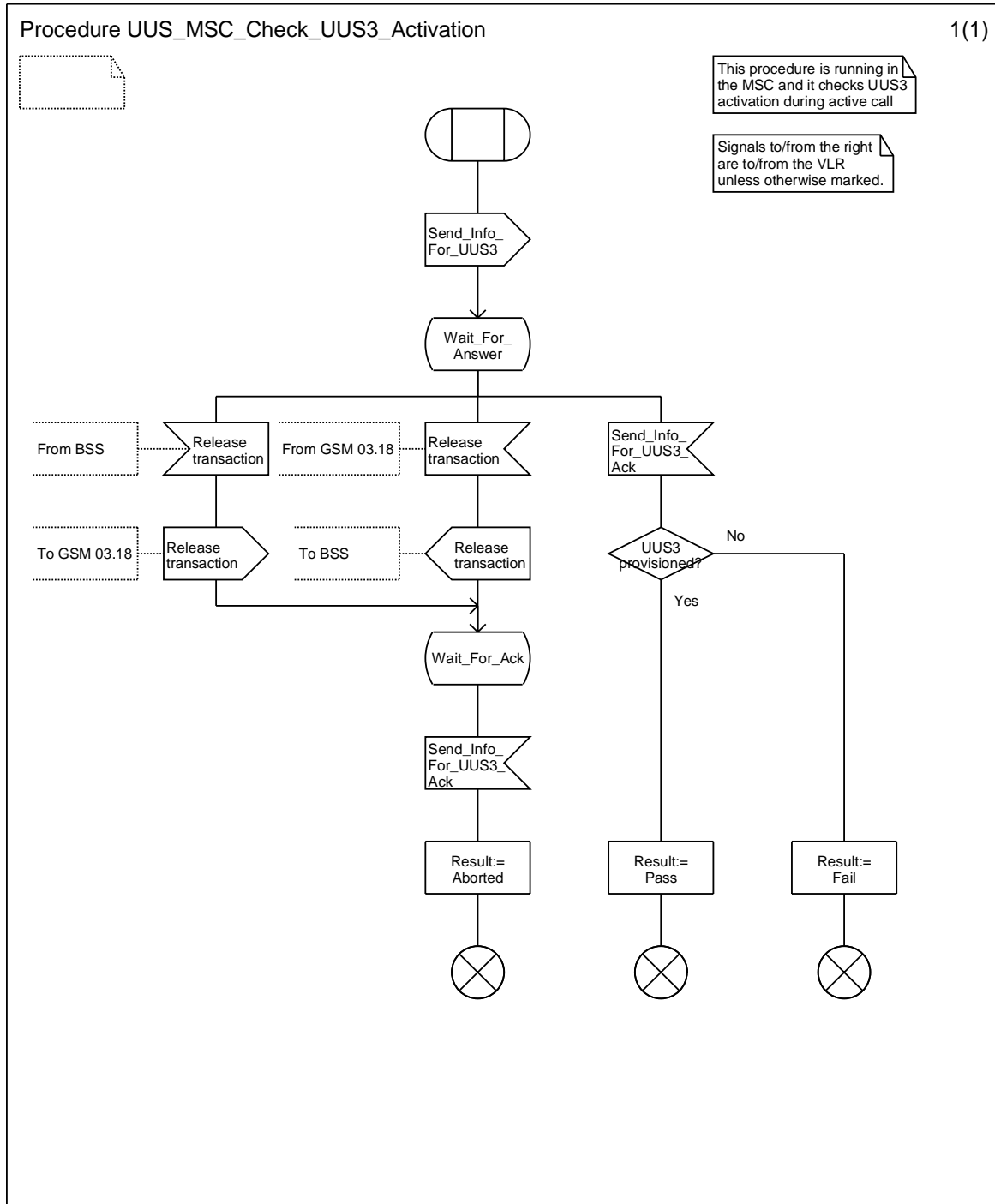

Figure 9.4.1.2: Procedure UUS_MSC_Check_UUS3_Activation

9.4.2 Process and procedures in serving VLR

Figure 9.4.2.1 Process Serving_VLR_Handle_UUS_In_Active_Call

This process is running in the serving VLR. If the UUS3 activation request comes during the active call, this process is used to check whether the service is provisioned to the subscriber.

Process Serving_VLR_Handle_UUS_In_Active_Call

1(1)

This process is running in the VLR and it checks the UUS3 provisioning status.

Signals to/from left are to/from MSC unless otherwise marked

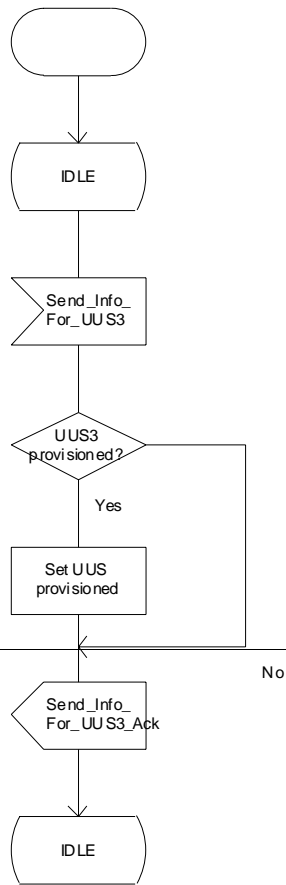

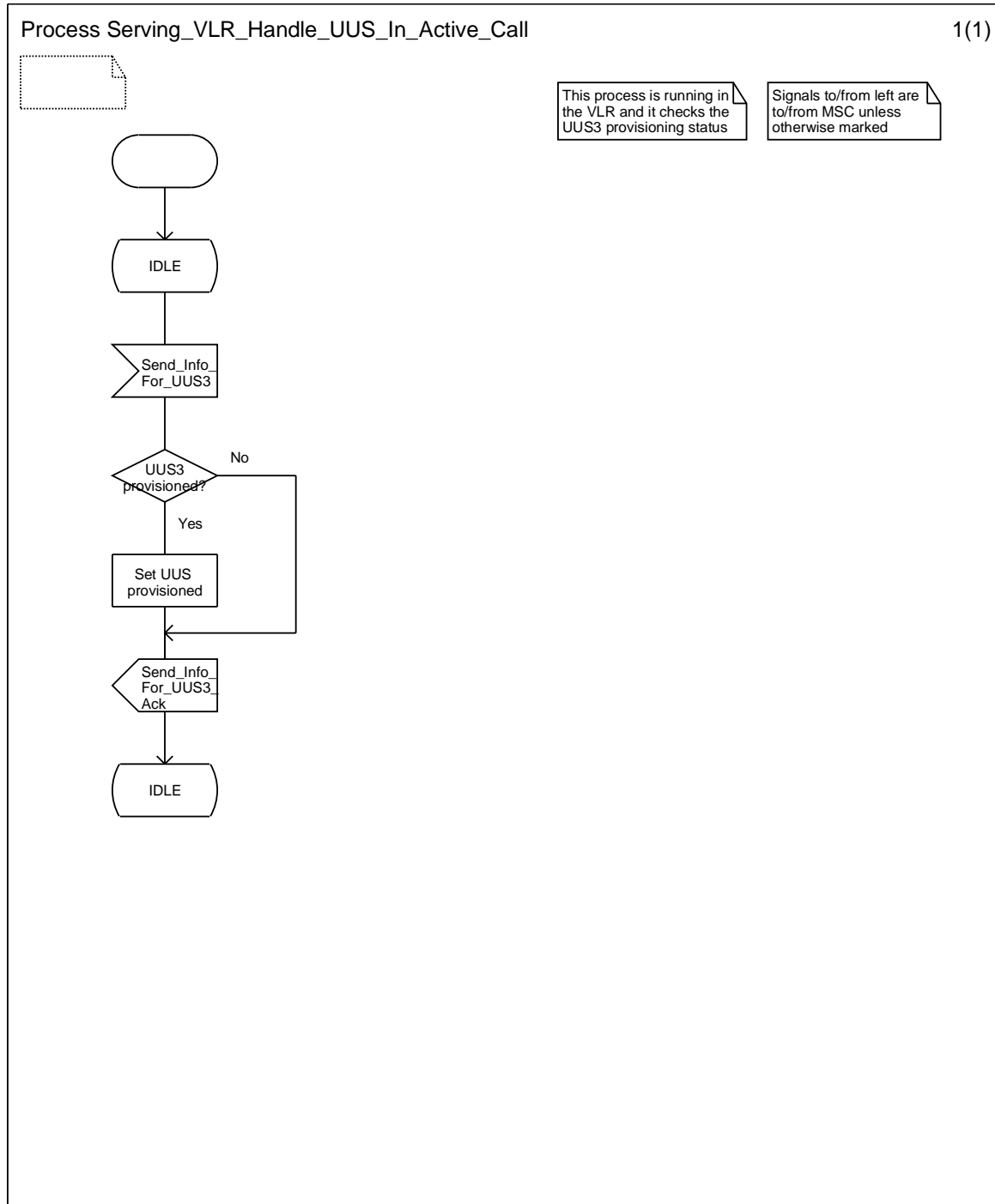

Figure 9.4.2.1: Process Serving_VLR_Handle_UUS_In_Active_Call

9.4.3 Process and procedures in remote MSC

Figure 9.4.3.1 Process Remote_MSC_Handle_UUS_In_Active_Call

This process is running in the remote MSC. It is used for checking whether UUS3 UUI's can be passed on and control the flow control for UUS3. The process starts during the call setup and checks the content of the Connect message in order to start the UUS3 flow control correctly. If the UUS3 is not activated the process stays in the Idle state and waits UUS3 activation request from the NW.

Process Remote_MSC_Handle_UUS_In_Active_Call

1(4)

This process is running in the remote MSC and it handles UUS3 flow control

Signals to/from the left are to/from the BSS; signals to/from the right are to/from the destination/originating exchange unless otherwise marked.

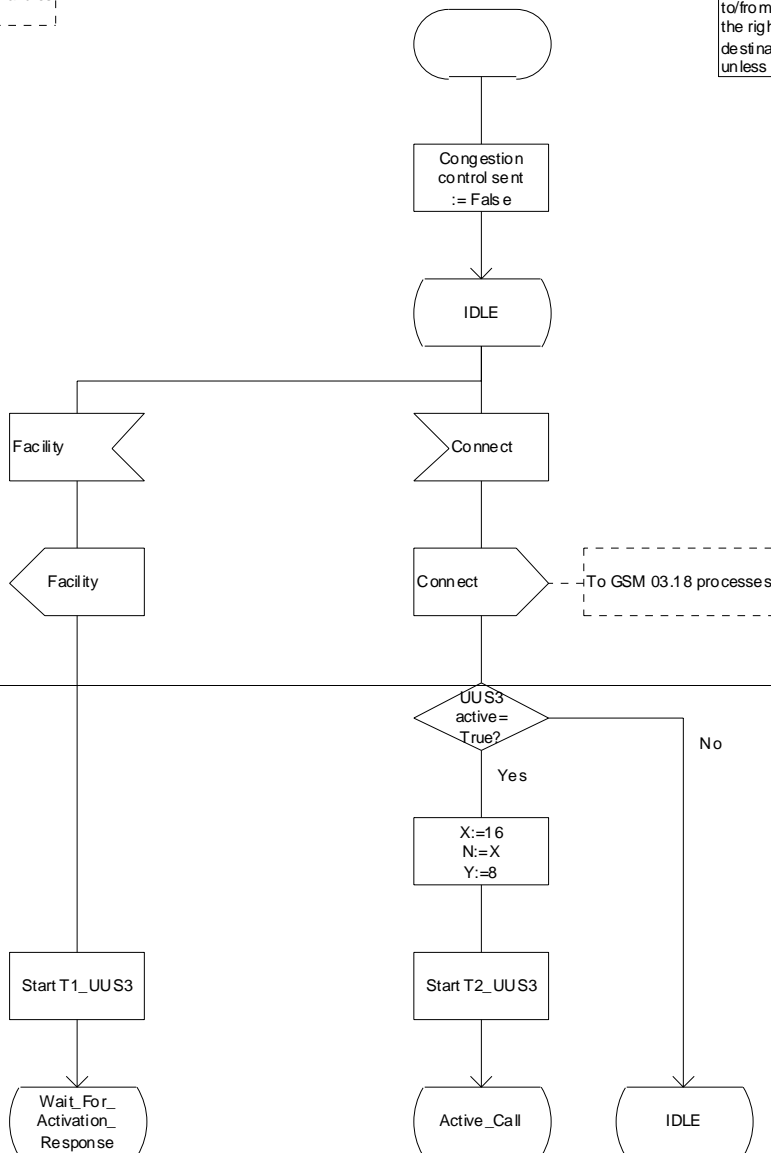

Process Remote_MSC_Handle_UUS_In_Active_Call

1(4)



This process is running in the remote MSC and it handles UUS3 flow control

Signals to/from the left are to/from the BSS; signals to/from the right are to/from the destination/originating exchange unless otherwise marked.

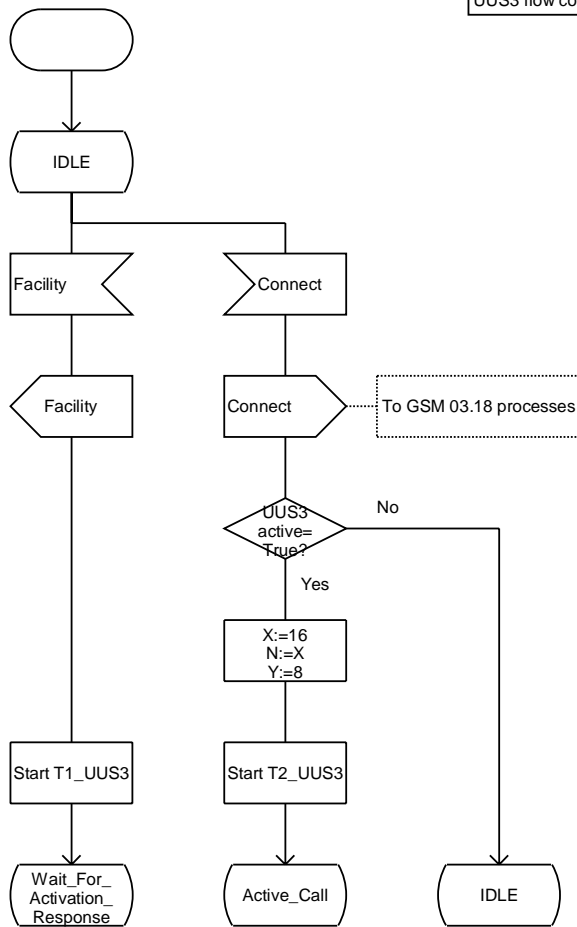

Figure 9.4.3.1: Process Remote_MSC_Handle_UUS_In_Active_Call (sheet 1)

Process Remote_MSC_Handle_UUS_In_Active_Call

2(4)

This process is running in the remote MSC and it handles UUS3 flow control.

Signals to/from the left are to/from the BSS; signals to/from the right are to/from the destination/originating exchange unless otherwise marked.

p = provided i.e. UUS3 service is provided
np = not provided i.e. UUS3 service is not provided

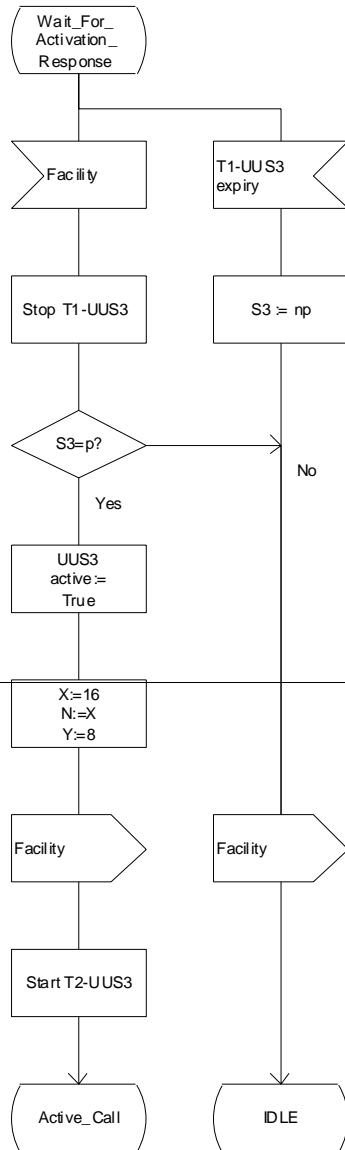

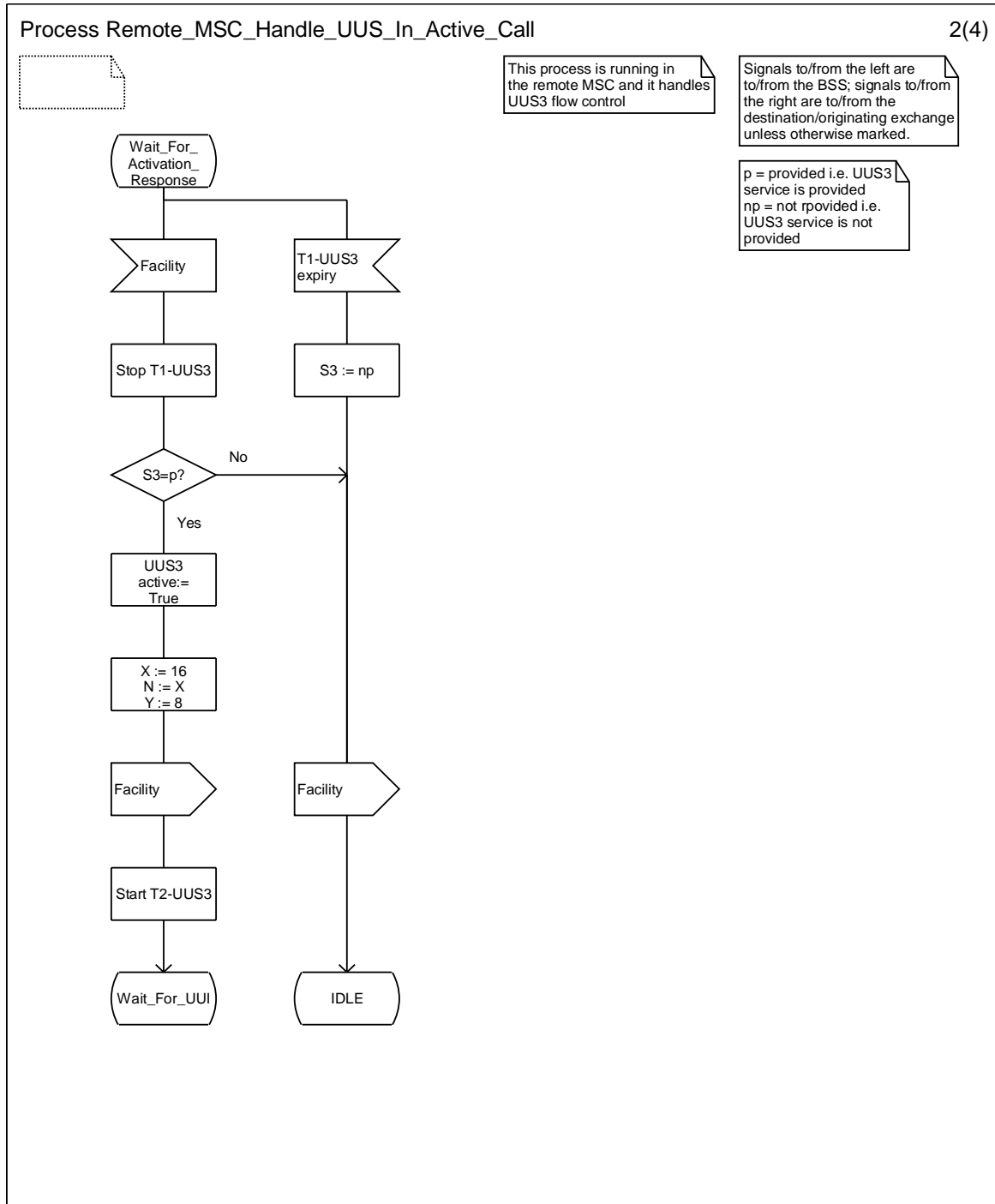

Figure 9.4.3.1: Process Remote_MSC_Handle_UUS_In_Active_Call (sheet 2)

Process Remote_MSC_Handle_UUS_In_Active_Call

3(4)

This process is running in the remote MSC and it handles UUS3 flow control.

Signals to/from the left are to/from the BSS; signals to/from the right are to/from the destination/originating exchange unless otherwise marked.

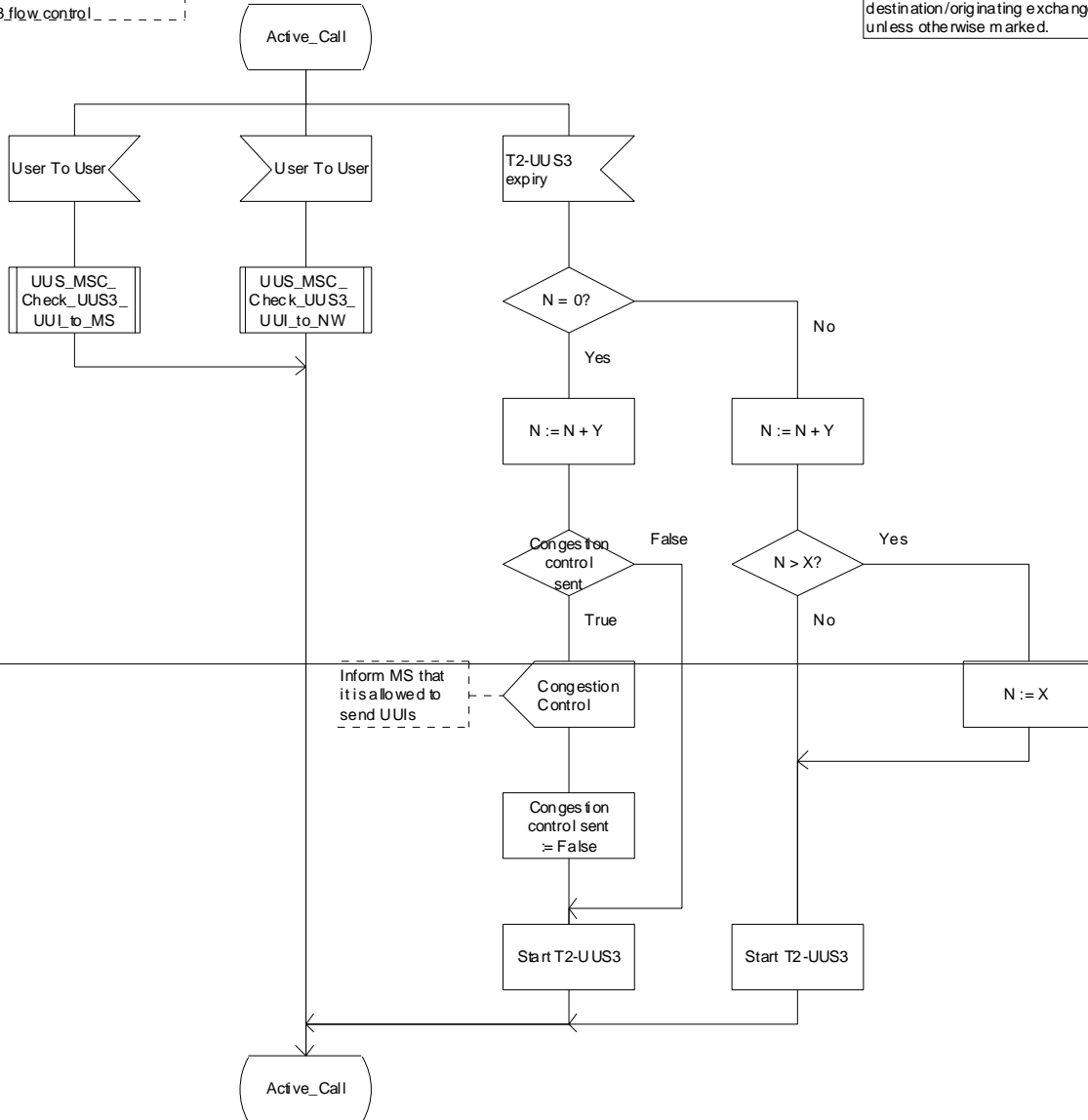

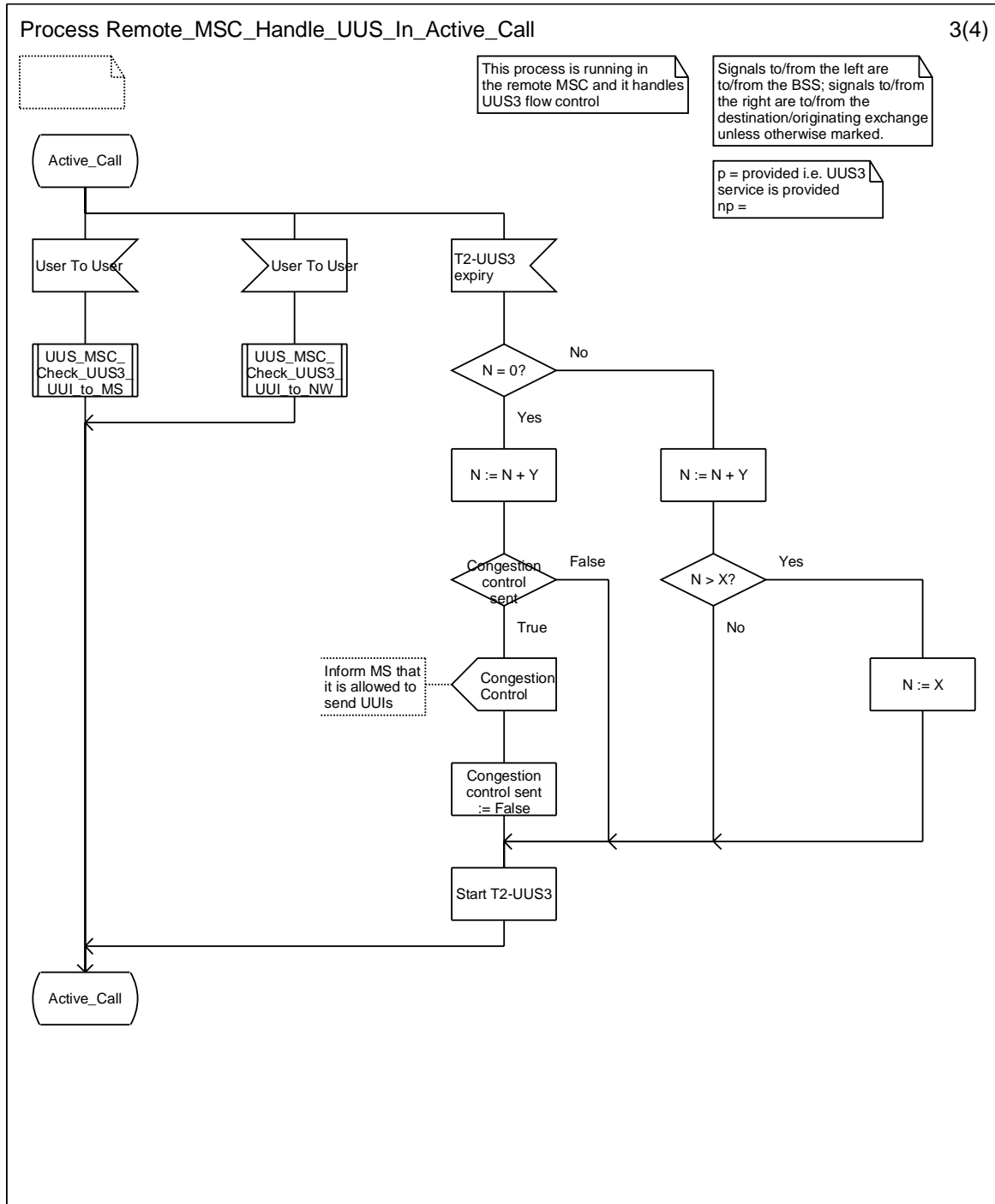

Figure 9.4.3.1: Process Remote_MSC_Handle_UUS_In_Active_Call (sheet 3)

Process Remote_MSC_Handle_UUS_In_Active_Call

4(4)

This process is running in the remote MSC and it handles UUS3 flow control.

Signals to/from the left are to/from the BSS; signals to/from the right are to/from the destination/originating exchange unless otherwise marked.

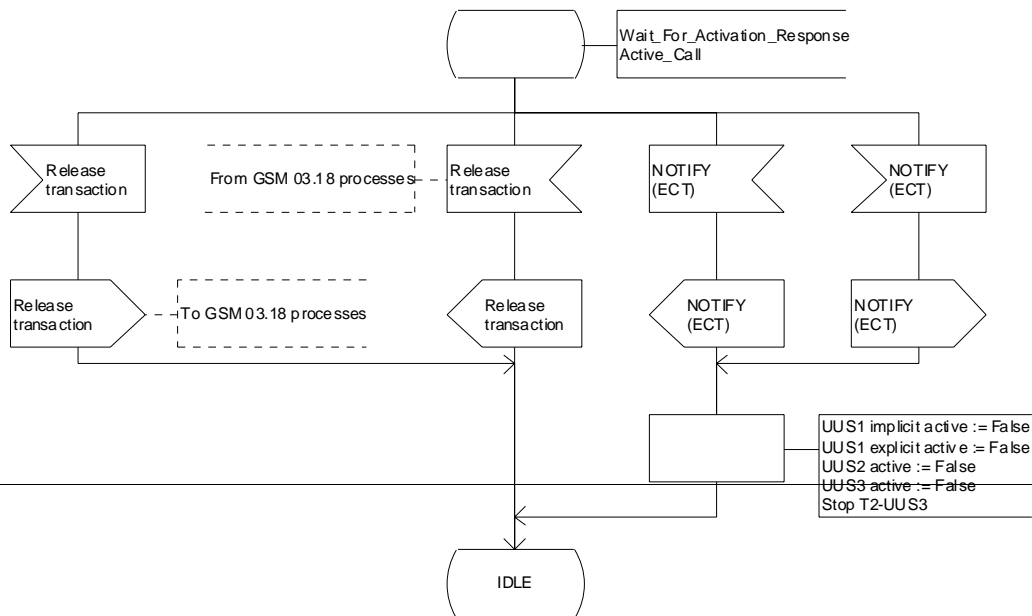

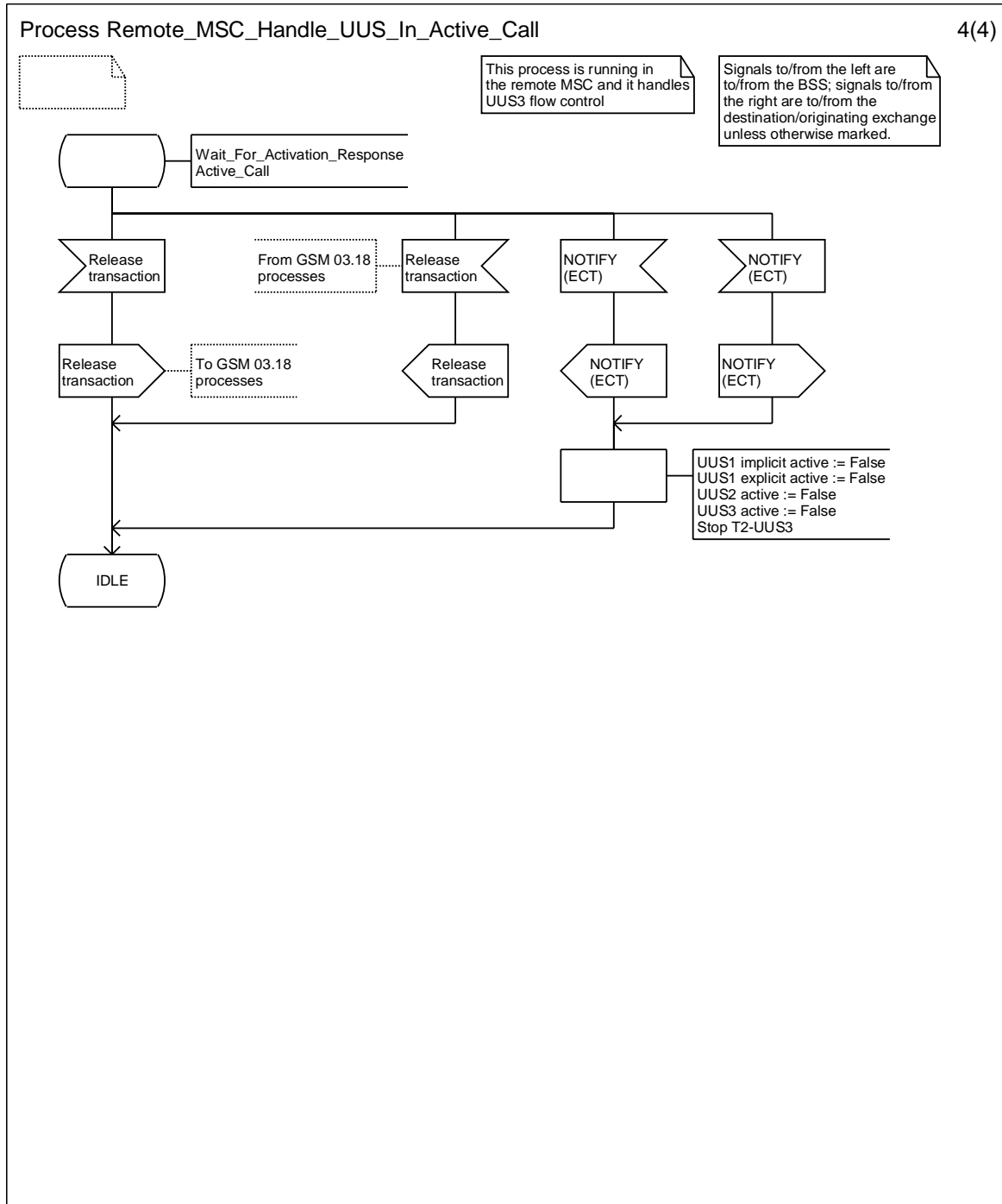

Figure 9.4.3.1: Process Remote_MSC_Handle_UUS_In_Active_Call (sheet 4)

CHANGE REQUEST		Please see embedded help file at the bottom of this page for instructions on how to fill in this form correctly.
23.088	CR 002	Current Version: 3.1.0
GSM (AA.BB) or 3G (AA.BBB) specification number ↑	↑ CR number as allocated by MCC support team	
For submission to: CN#09 <small>list expected approval meeting # here ↑</small>	for approval <input checked="" type="checkbox"/> for information <input type="checkbox"/>	strategic <input type="checkbox"/> non-strategic <input checked="" type="checkbox"/> <small>(for SMG use only)</small>

Form: CR cover sheet, version 2 for 3GPP and SMG The latest version of this form is available from: <ftp://ftp.3gpp.org/Information/CR-Form-v2.doc>

Proposed change affects: (U)SIM ME UTRAN / Radio Core Network
(at least one should be marked with an X)

Source: N4 **Date:** 2000-06-26

Subject: SDL refresh

Work item: TEI

Category:	F Correction <input type="checkbox"/> A Corresponds to a correction in an earlier release <input type="checkbox"/> B Addition of feature <input type="checkbox"/> C Functional modification of feature <input type="checkbox"/> D Editorial modification <input checked="" type="checkbox"/>	Release:	Phase 2 <input type="checkbox"/> Release 96 <input type="checkbox"/> Release 97 <input type="checkbox"/> Release 98 <input type="checkbox"/> Release 99 <input checked="" type="checkbox"/> Release 00 <input type="checkbox"/>
<small>(only one category shall be marked with an X)</small>			

Reason for change: The SDL diagrams in this document have been replaced, without any semantic changes due to the following reasons:

- In the previous version, the diagrams contained nothing but garbage when viewed on-screen.
- Some of the diagrams were, if not impossible, very hard to print.
- A binary version of the SDL diagrams, suitable for standard tools, is needed to assure a qualitative handling of the diagrams in the future. Telelogic Tau SDL Suite (formerly known as SDT) versions of the diagrams have been created and made available, providing a new fresh base for future changes. For obvious reasons, the binary version, to be regarded as the source, should be mirrored in the document. Therefore, the diagrams replacing the previous versions are printouts of the binary versions.

Clauses affected: All figures in the document, containing an SDL diagram.

Other specs Affected:	Other 3G core specifications <input type="checkbox"/> Other GSM core specifications <input type="checkbox"/> MS test specifications <input type="checkbox"/> BSS test specifications <input type="checkbox"/> O&M specifications <input type="checkbox"/>	→ List of CRs: → List of CRs: → List of CRs: → List of CRs: → List of CRs:	
------------------------------	---	--	--

Other comments: ETSI plans to make the binary versions of the SDL diagrams available on the 3GPP web-site.

6.1.2.3 Interactions with call forwarding supplementary services

For interactions with call forwarding supplementary services see 3G TS 22.082.

The SDL diagram in figure 6.3 shows the function to be performed in the HLR in order to deal with the interactions with call forwarding supplementary services.

Process BO1

388_11(1)

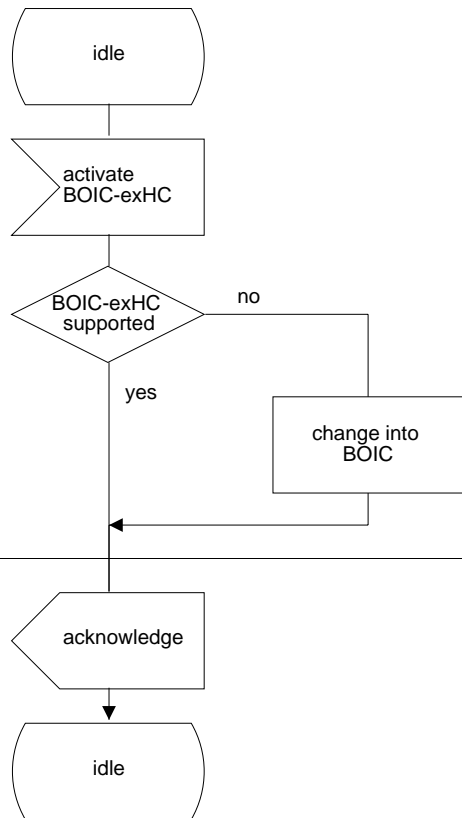

BOIC-exHC: Barring of Outgoing International Calls except those directed to the home PLMN country.
BOIC: Barring of Outgoing International Calls.

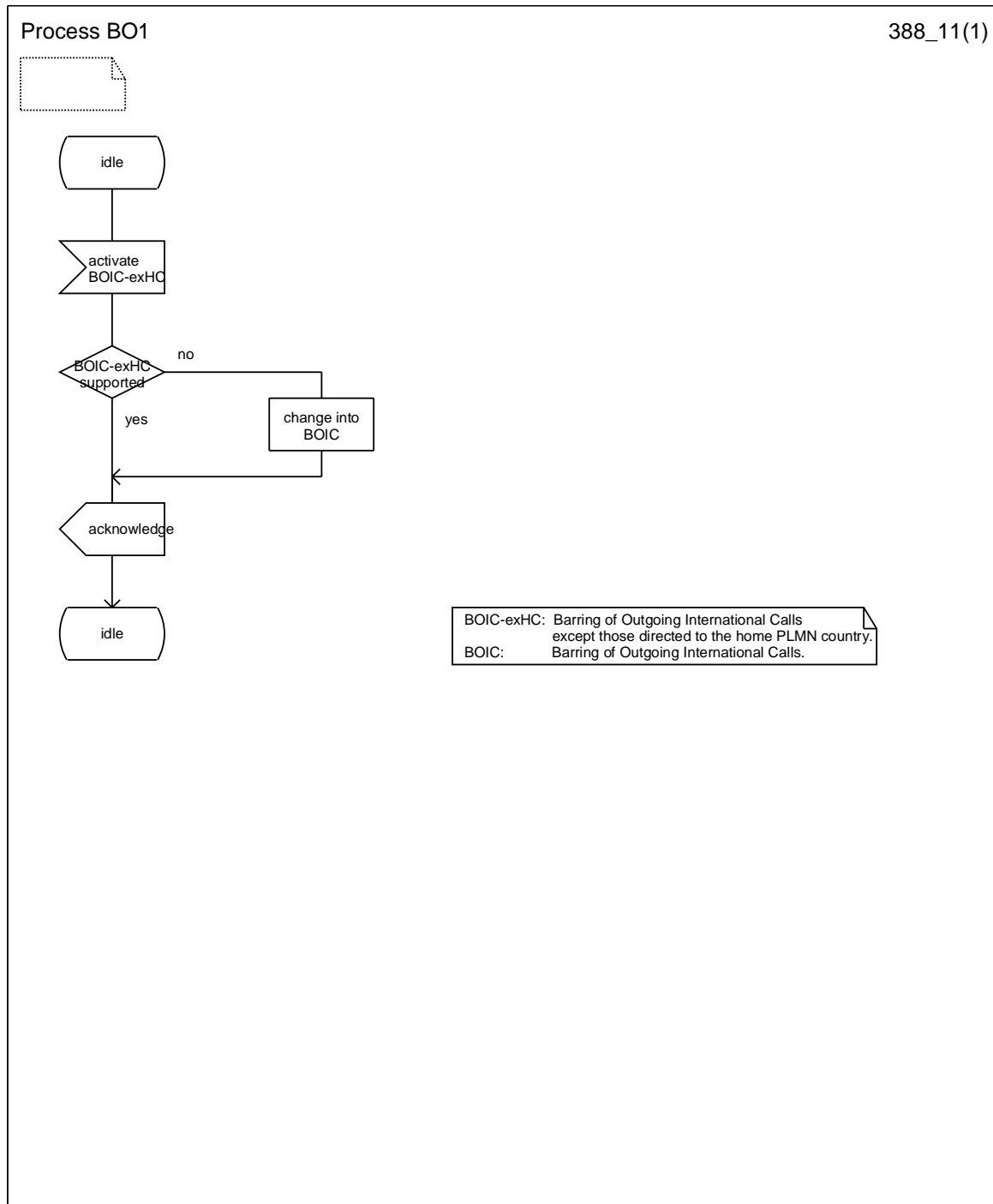
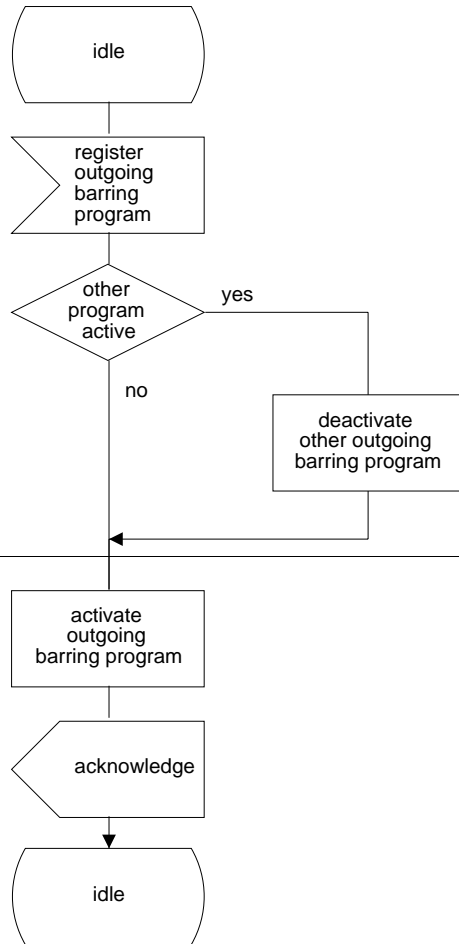

Figure 6.1: BO1 Possible change of barring of outgoing international calls except those directed to the home PLMN country into barring of outgoing international calls

Process BO2

388_12(1)



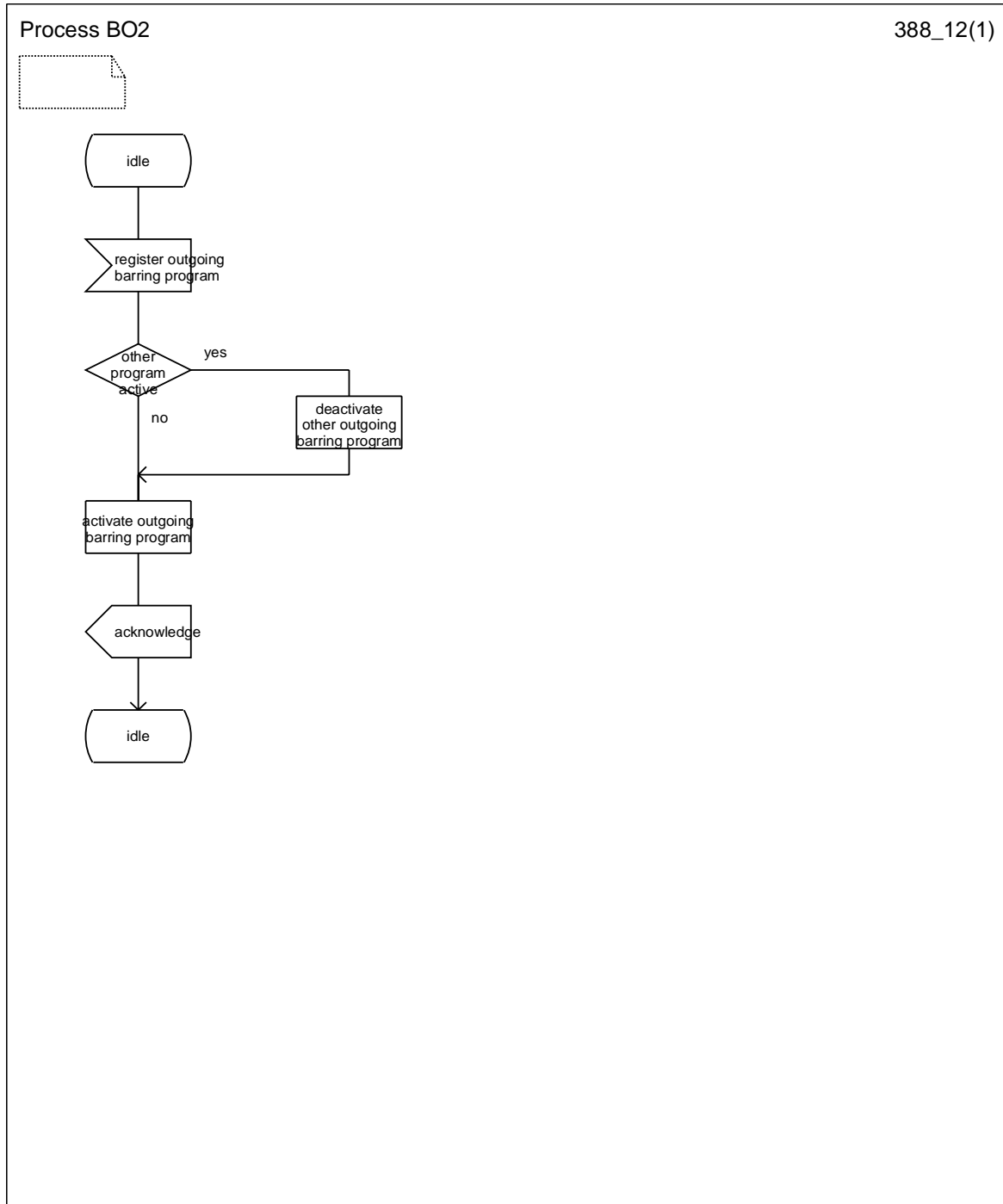
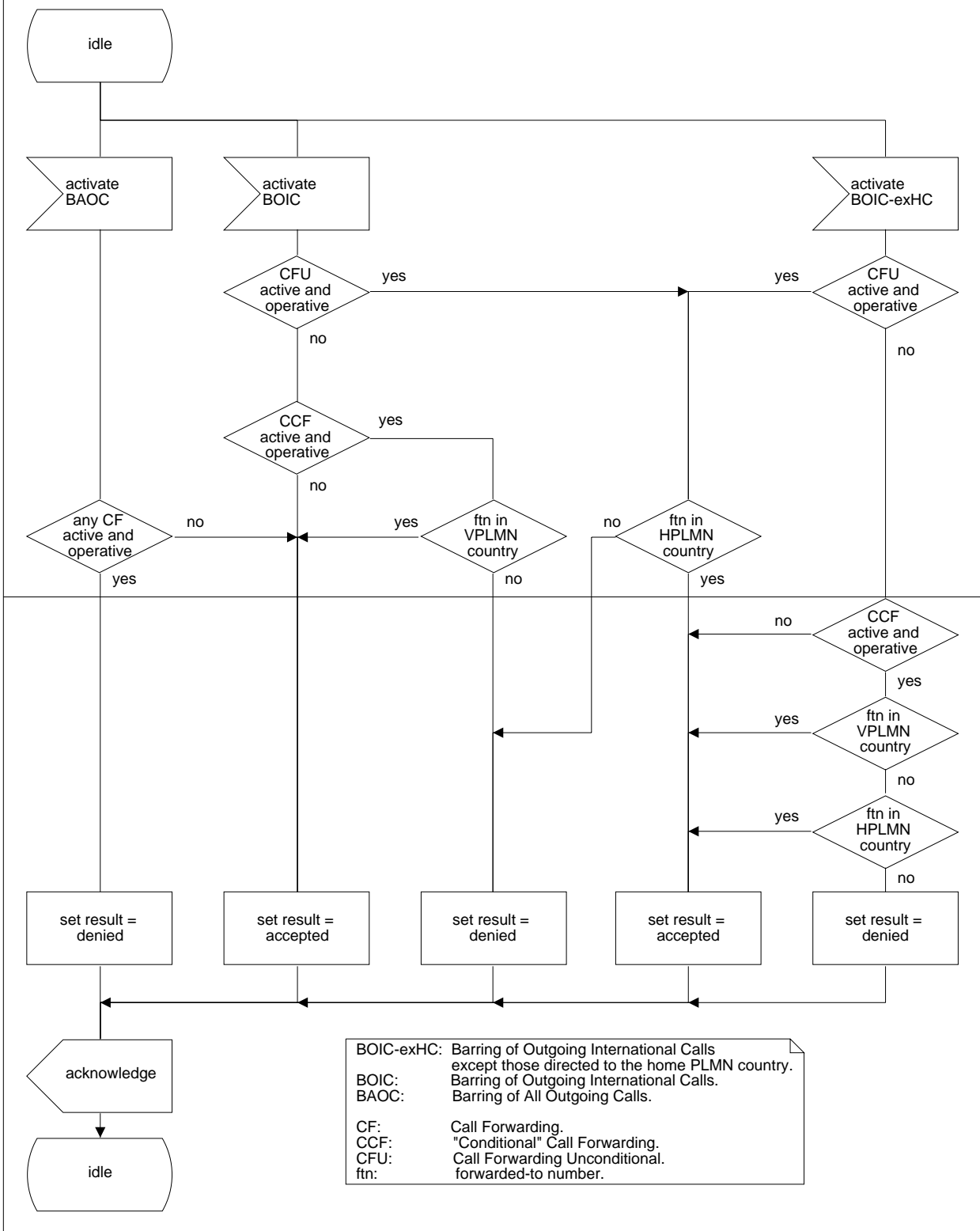

Figure 6.2: BO2 Interaction between call barring programs

Process BO3

388_13(1)



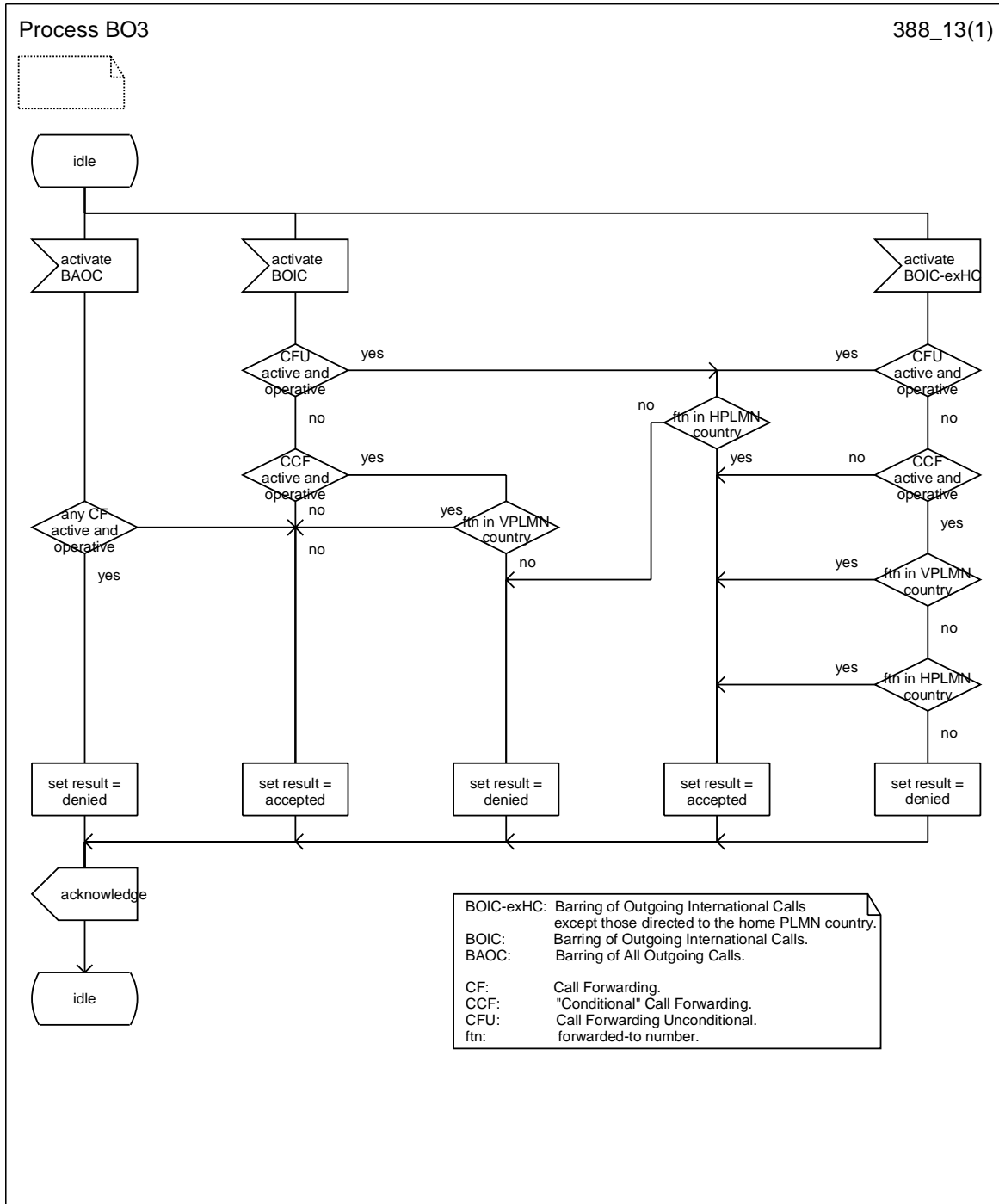
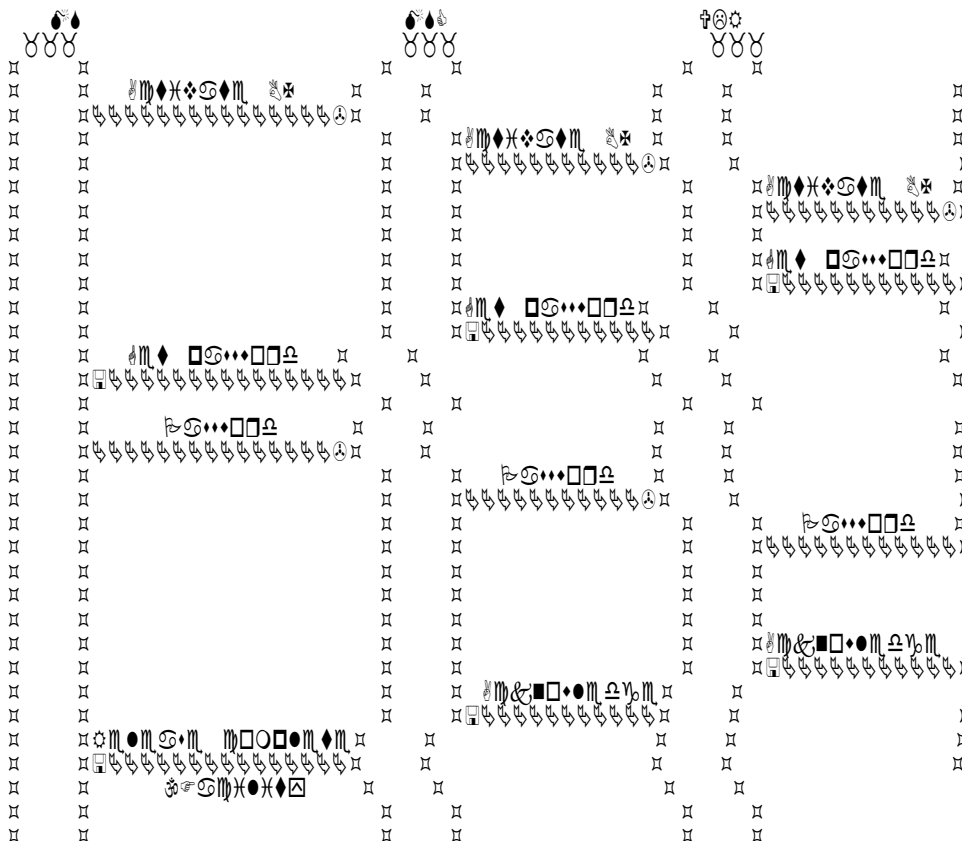

Figure 6.3: BO3 Interaction between call forwarding supplementary services and barring of outgoing calls programs



NOTE: BX indicates any of the barring programs. PW1 and PW2 indicate password handling programs, see 3G TS 23.011.

Figure 6.4: Activation of barring of outgoing calls

6.1.3 Deactivation

The procedure for activation, described in subclause 1.1.2.1, is valid also correspondingly for deactivation with the addition that a barring supplementary service, i.e. the Outgoing barring service, or All barring services can be signalled.

The information flow for deactivation of barring of outgoing calls is shown in figure 6.5. For more details see 3G TS 23.011.

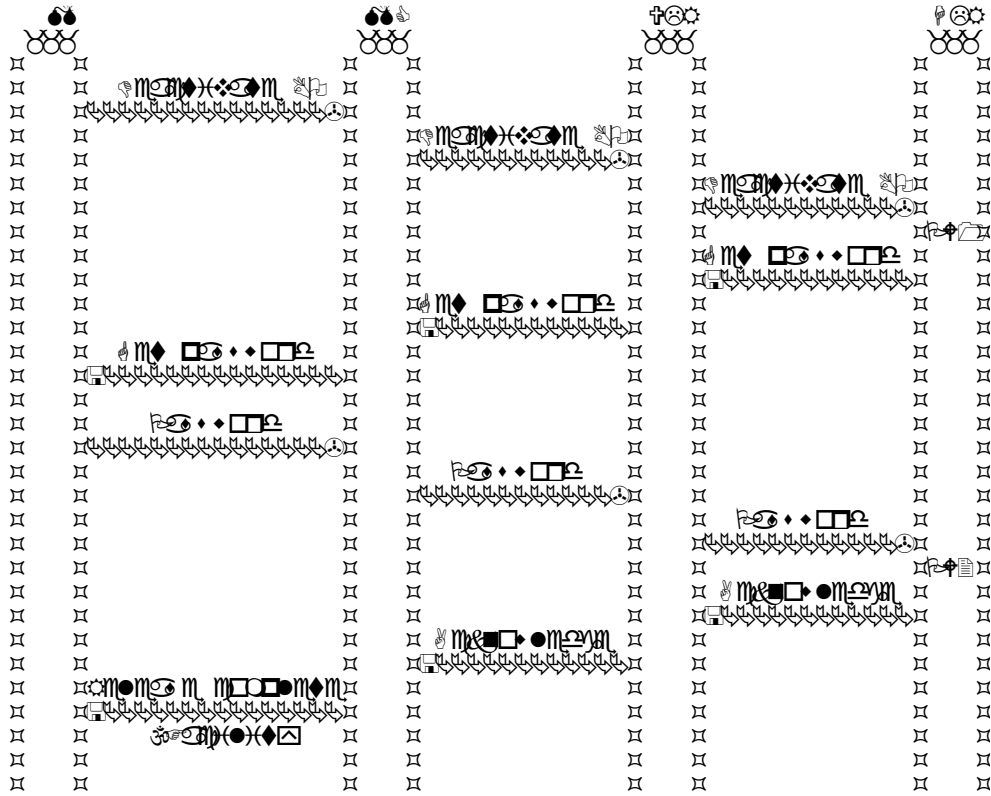

NOTE: BO indicates the general code for barring of outgoing calls. PW1 and PW2 indicate password handling programs, see 3G TS 23.011.

Figure 6.5: Deactivation of barring of outgoing calls

6.1.4 Interrogation

The interrogation procedure enables the mobile subscriber to obtain information about the data stored in the PLMN. After having requested this procedure the network shall return a list of all basic services to which the given barring program is active.

The information flow for interrogation of barring of outgoing calls is shown in figure 6.6.

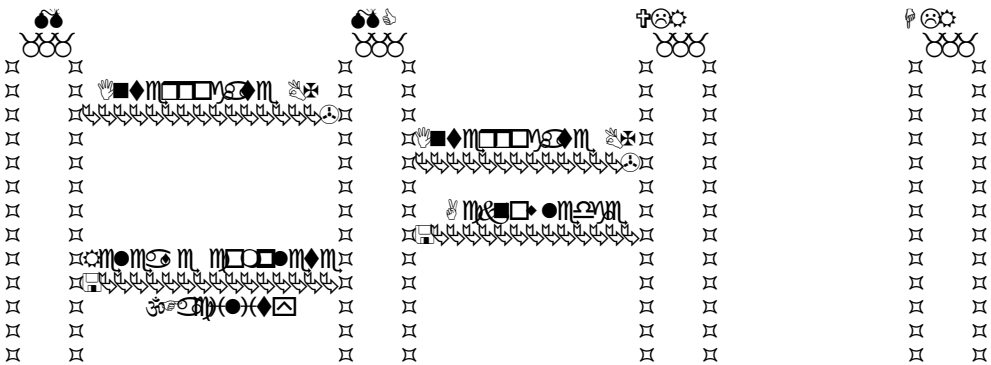

NOTE: BX indicates any of the barring programs.

Figure 6.6: Interrogation of barring of outgoing calls

6.2 Functions and information flows

The following Mobile Additional Functions have been identified:

MAF017

Barring of all outgoing calls related authorizations examination.

The ability of a PLMN component to determine the authorizations relating to barring of all outgoing calls. See figure 6.7.

Location: VLR

MAF018

Barring of outgoing international calls related authorizations examination.

The ability of a PLMN component to determine the authorizations relating to barring of outgoing international calls. See figure 6.8.

Location: VLR

MAF020

Barring of outgoing international calls except those directed to the home PLMN country related authorizations examination.

The ability of a PLMN component to determine the authorizations relating to barring of outgoing international calls except those directed to the home PLMN country. See figure 6.9.

Location: VLR

The information flow for barring of outgoing calls is shown in figure 6.10.

Process MAF017

388_17(1)

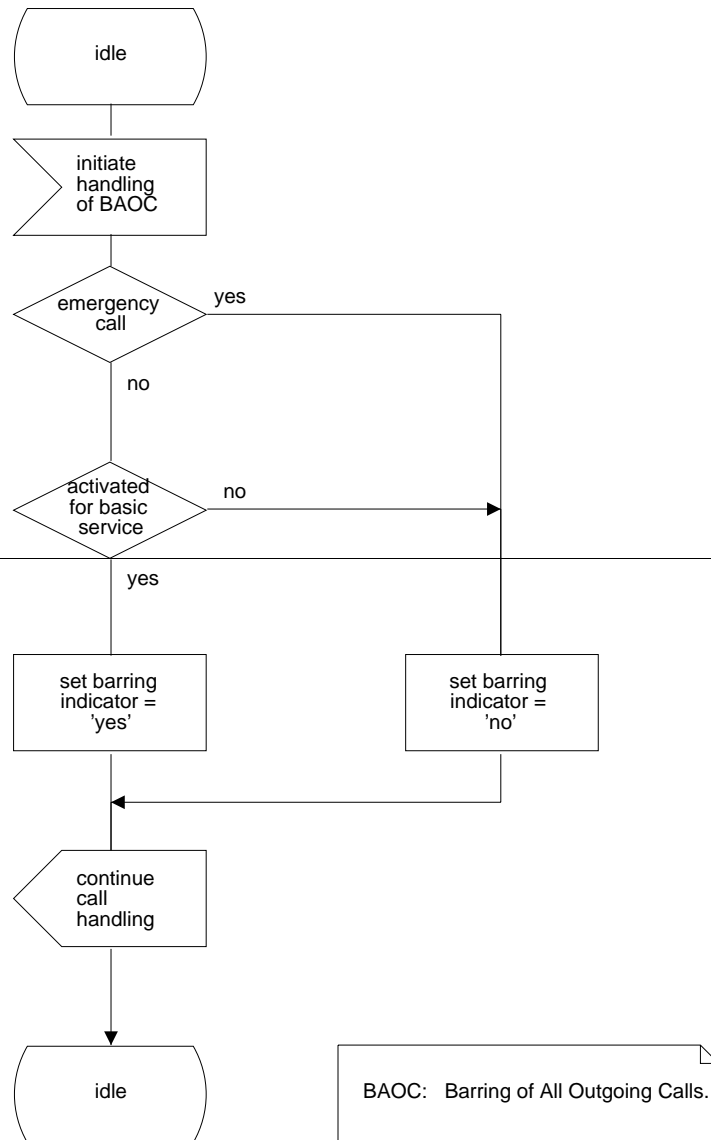

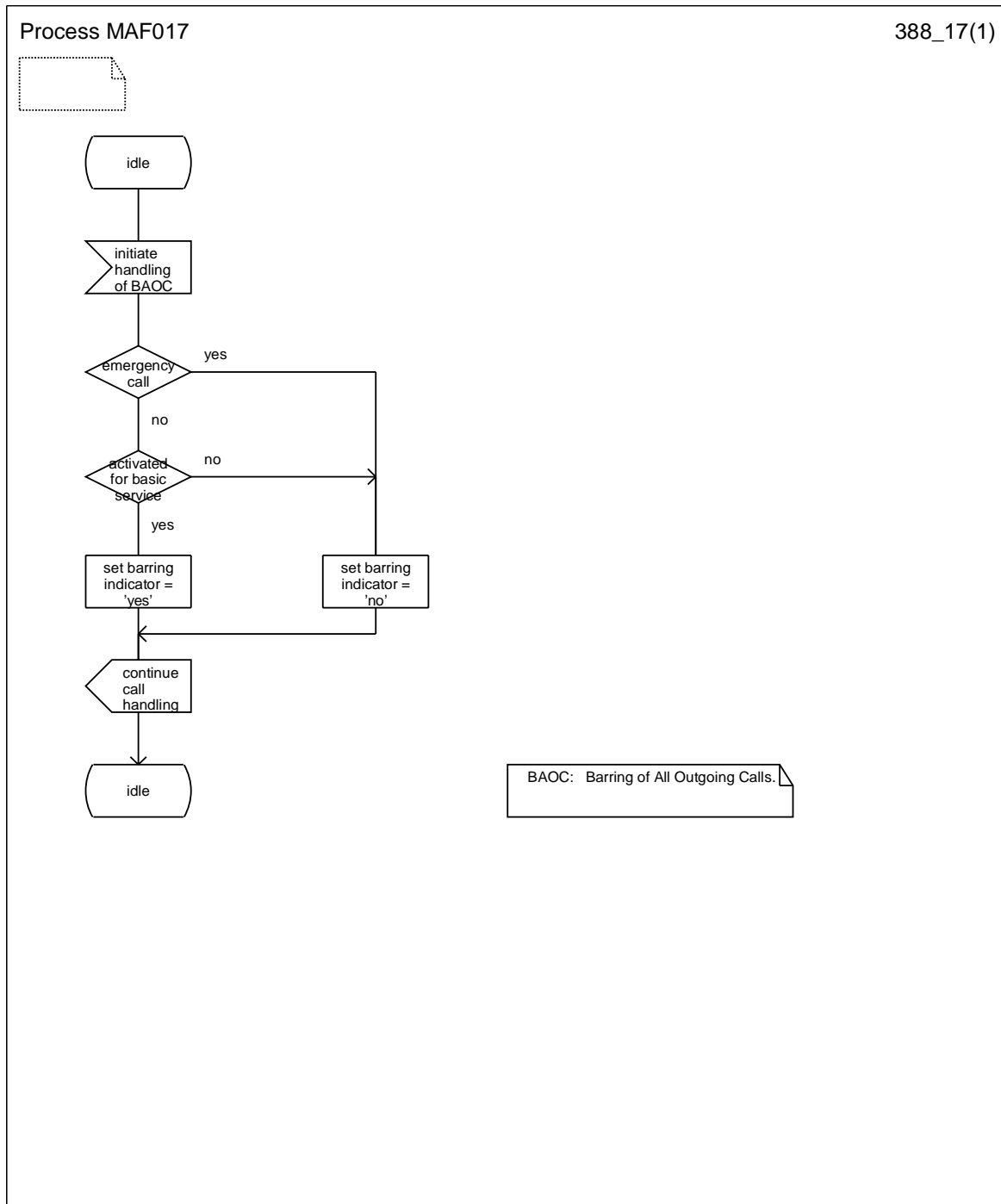
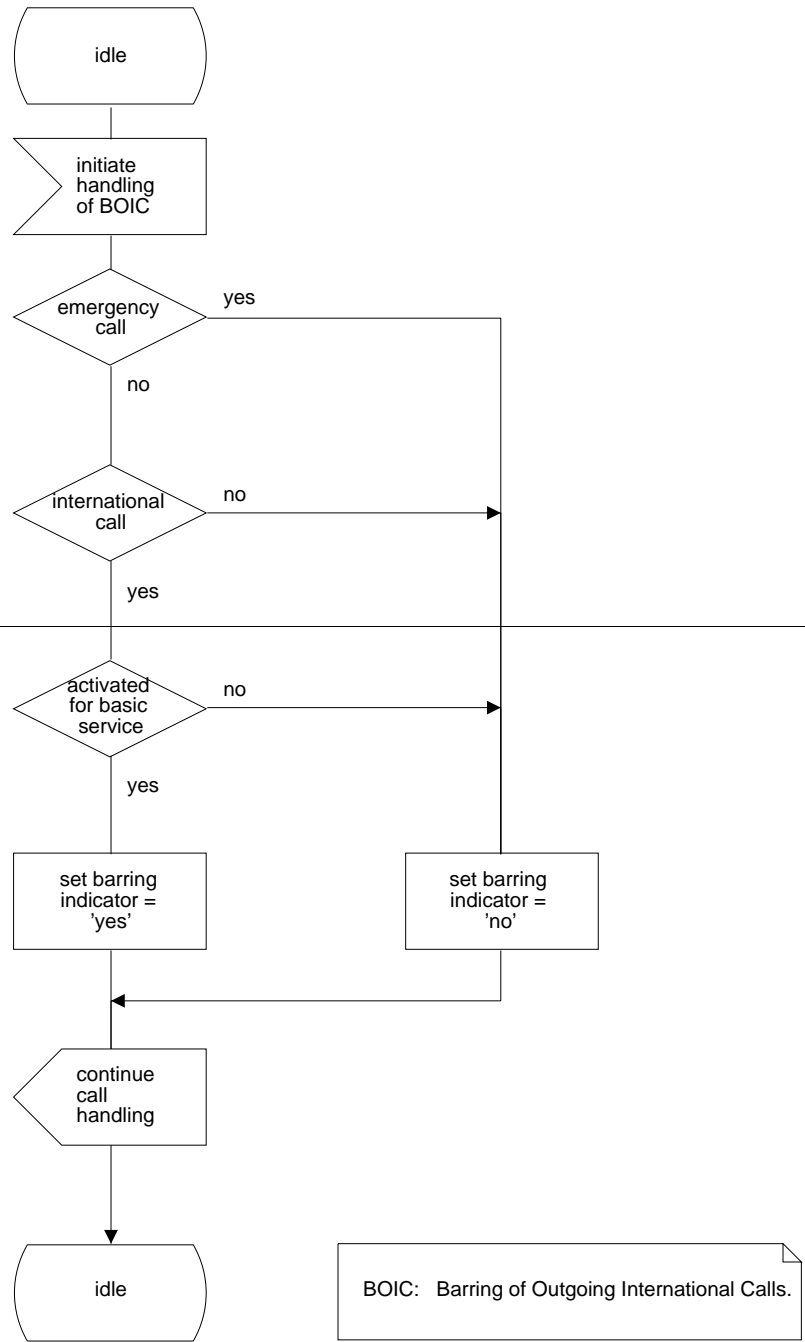

Figure 6.7: MAF017 Barring of all outgoing calls related authorisations examination (VLR)

Process MAF018

388_18(1)



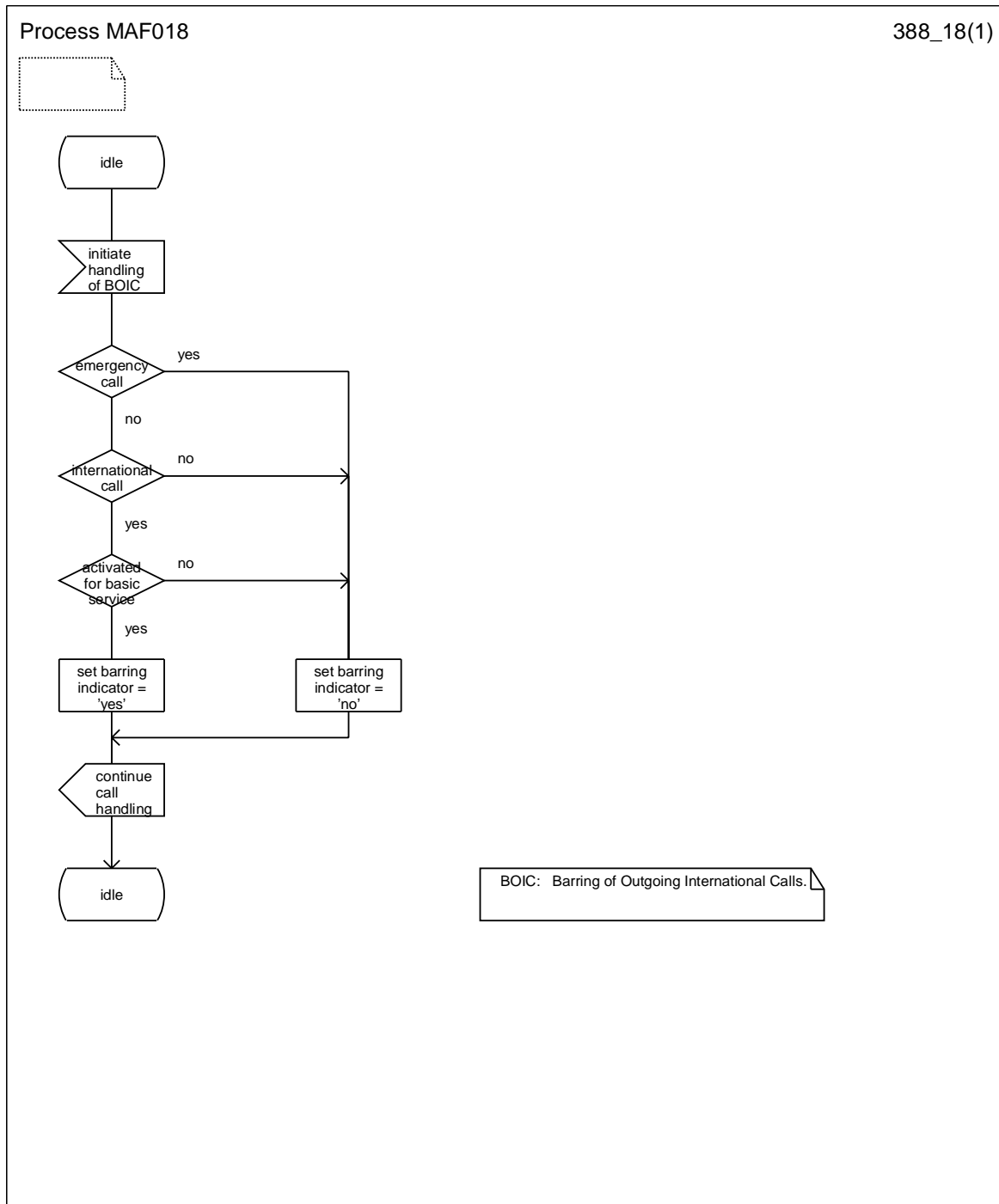
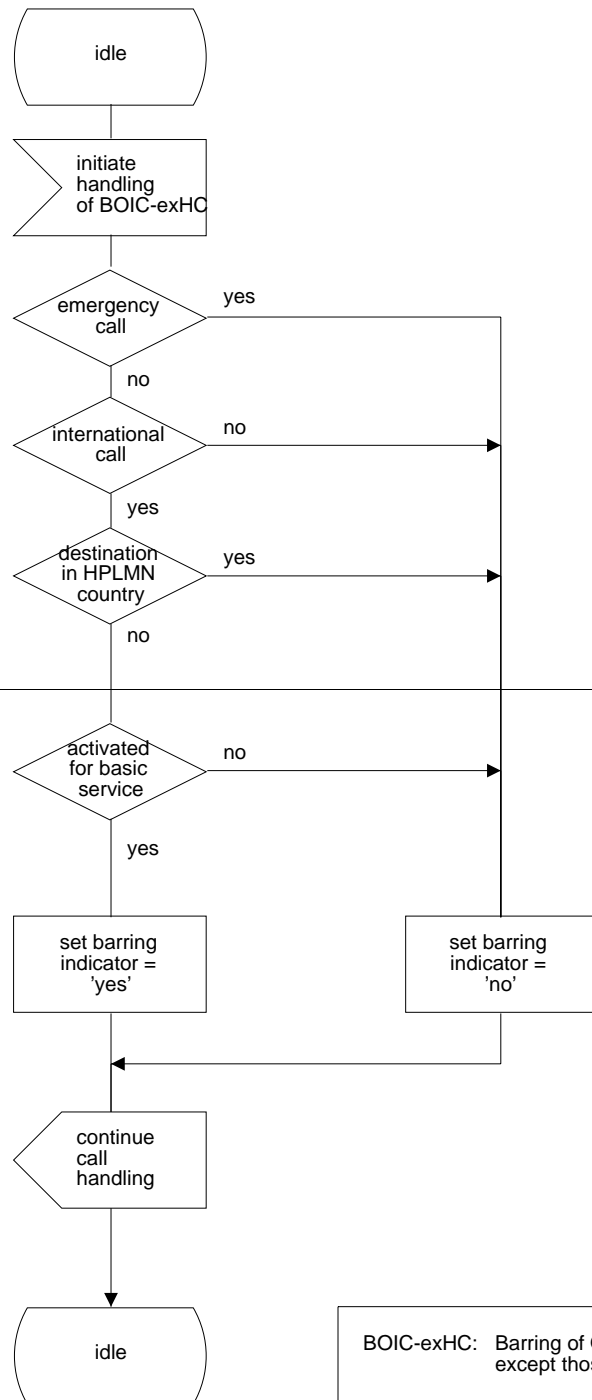

Figure 6.8: MAF018 Barring of all outgoing international calls related authorisations examination (VLR)

Process MAF020

388_19(1)

Figure 1.9



BOIC-exHC: Barring of Outgoing International Calls except those directed to the home PLMN country.

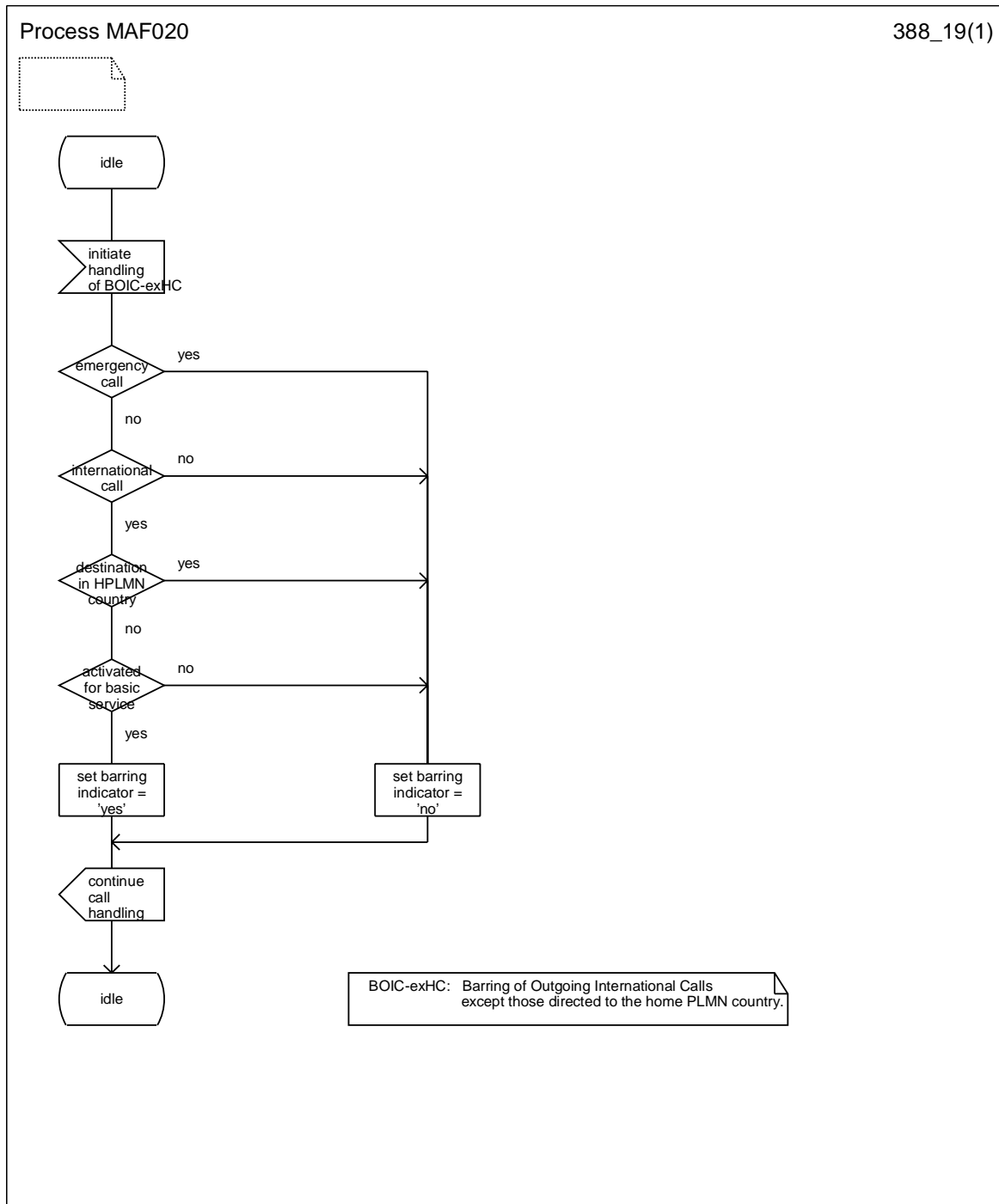
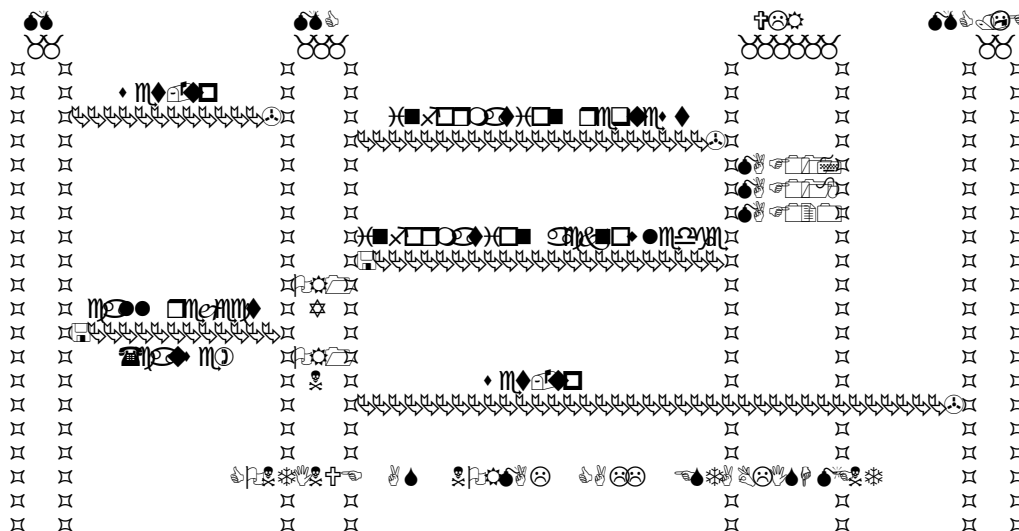

Figure 6.9: MAF020 Barring of outgoing international calls except those directed to the home PLMN country related authorisations examination (VLR)



NOTE: OR1: call barred Y: yes N: no

Figure 6.10: Information flow for barring of outgoing calls

6.3 Information stored in the HLR

For all call barring supplementary services in the HLR must be stored:

- the subscription option "control of barring services" on per subscriber basis.

This subscription option takes one of the following values:

- by subscriber using password;
- by the service provider.

If the subscription option "control of barring services" has been set to "by subscriber using password" for barring of outgoing calls in the HLR must be stored on per subscriber basis:

- the registration parameter "call barring password".

The password is valid for all basic services to which barring of outgoing calls applies;

- the status parameter "wrong password attempts counter" associated with the password.

Note that the subscription option and the call barring password are parameters which are associated with all call barring services.

The outgoing calls barring program may have the following logical states (refer to 3G TS 23.011 for an explanation of the notation):

Provisioning State	Registration State	Activation State	HLR Induction State
(Not Provisioned,	Not Applicable,	Not Active,	Not Induced)
(Provisioned,	Not Applicable,	Not Active,	Not Induced)
(Provisioned,	Not Applicable,	Active and Operative,	Not Induced)
(Not Provisioned,	Not Applicable,	Not Active,	Induced)
(Provisioned,	Not Applicable,	Not Active,	Induced)
(Provisioned,	Not Applicable,	Active and Operative,	Induced)

The activation and HLR induction states may be different for each applicable elementary basic service group.

The provisioning state shall be on a per subscriber basis, and hence the same for all basic service groups.

The HLR shall also store the logical state of the outgoing calls barring program (which shall be one of the valid states listed above) for each applicable elementary basic service group.

6.4 State transition model

The following figure shows the successful cases of transition between the applicable logical states of the barring of outgoing call program. The state changes are either caused by actions of the service provider, the mobile user or the network.

Note that error cases are not shown in the diagram as they normally do not cause a state change. Additionally, some successful requests may not cause a state change. Hence, they are not shown in diagram.

The diagram only shows operations on an elementary basic service group.

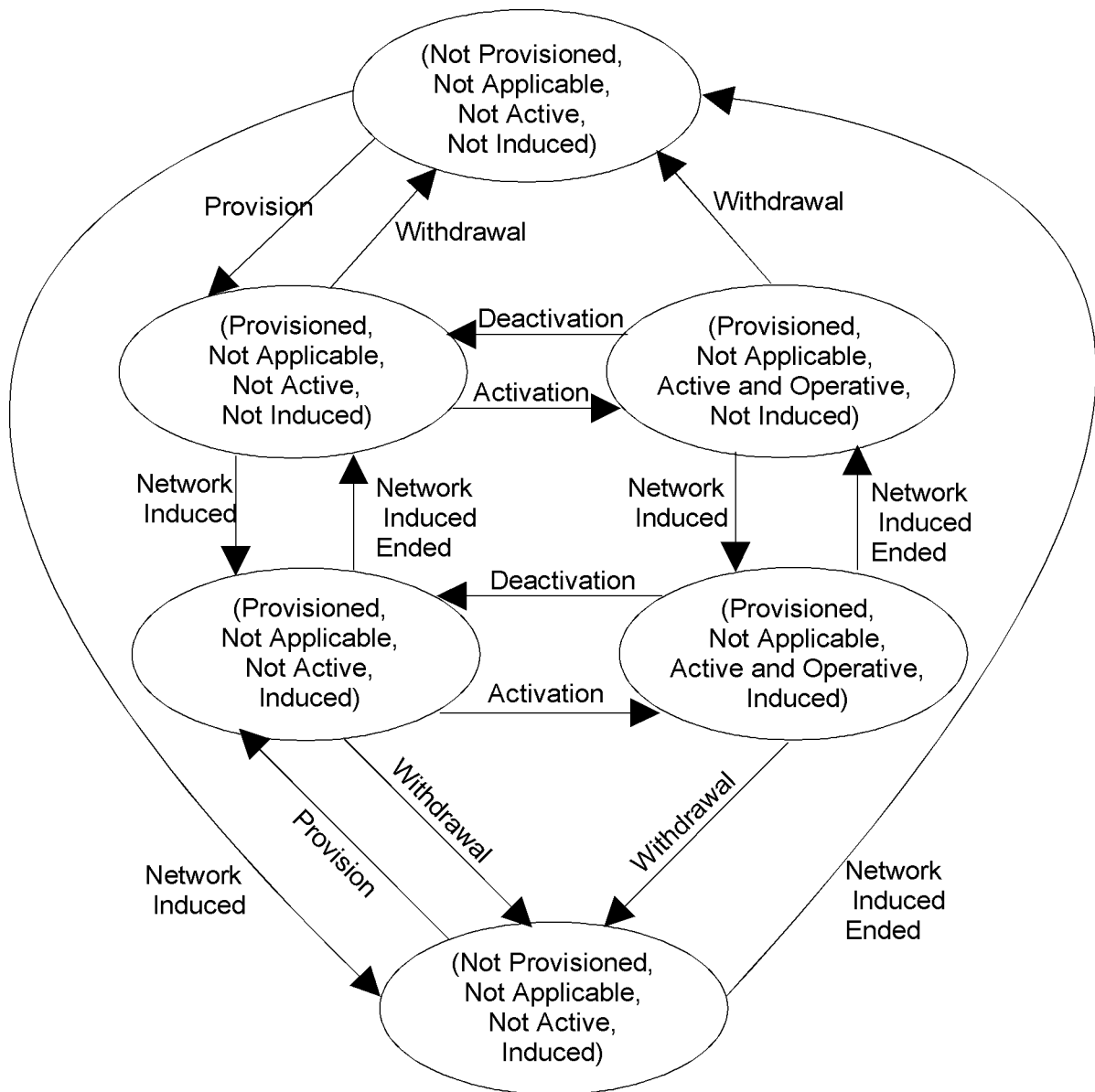

Figure 6.11: State transition model for BAOC, BOIC and BOIC-exHC

6.5 Transfer of information from HLR to VLR

If the provisioning state for the outgoing calls barring program is "Provisioned" then when the subscriber registers on a VLR the HLR shall send that VLR information about the logical state of the program for all relevant elementary basic service groups.

If the HLR induction state for the outgoing calls barring program is "Induced" then when the subscriber registers on a VLR the HLR shall send that VLR information about the logical state of the program for all relevant elementary basic service groups.

If the logical state of the outgoing calls barring program is changed while a subscriber is registered on a VLR then for the affected basic service groups, the HLR shall inform the VLR of the new logical state of the program.

6.6 Information stored in the VLR

For each barring of outgoing calls program the VLR shall store the service state information received from the HLR.

6.7 Handover

Handover will have no impact on the control procedures and the operation of the service.

6.8 Cross Phase compatibility

6.8.1 MS, MSC, VLR or HLR only support Phase 1 control of SS by the subscriber

In response to a Barring of outgoing calls interrogation request, if the MS or any network element involved is of Phase 1, only information concerning basic service groups for which the activation state has the value "Active and Operative" will be returned.

6.8.2 HLR only support Phase 1 updating of subscriber information

If the VLR receives the SS-status parameter from a Phase 1 HLR it shall act as if it has received the SS-Status parameter with the values shown in the following:

- 1) Activated => P bit = 1, R bit = 0 or 1, A bit = 1, Q bit = 0;
- 2) Deactivated => P bit = 1, R bit = 0 or 1, A bit = 0, Q bit = 0 or 1.

7 Barring of incoming calls

7.1 Handling of barring of incoming calls

7.1.1 Registration

If the served mobile subscriber at provision time has selected the subscription option "control of barring services by subscriber using password", he has to register a password at provision time. Furthermore the served mobile subscriber can change the password by an appropriate control procedure at any time. The control procedure consists of three steps: first, the old password has to be provided. Secondly, the new password has to be given, after which it has to be verified by providing it once more, see 3G TS 23.011.

If the served mobile subscriber at provision time has selected the subscription option "control of barring services by the service provider" an attempt to register a password will be denied and the served mobile subscriber should receive a notification.

The subscriber can register a new password, thus causing the previous registration to be overridden, see 3G TS 23.011.

7.1.2 Activation

7.1.2.1 General

The procedure for activation of Barring of outgoing calls, described in subclause 1.1.2.1, is valid also for activation of Barring of incoming calls.

The information flow for activation of barring of incoming calls is shown in figure 7.3. For more details see 3G TS 23.011.

7.1.2.2 Interactions between barring of incoming call programs

In case the mobile subscriber activates barring of all incoming calls and barring of incoming calls when roaming outside the home PLMN country was already activated, barring of incoming calls when roaming outside the home PLMN country will be deactivated and barring of all incoming calls will be activated.

The SDL diagram in figure 7.1 shows the function to be performed in the HLR in order to deal with this interaction between call barring services.

7.1.2.3 Interactions with call forwarding supplementary services

For interactions with call forwarding supplementary services see 3G TS 22.082.

The SDL diagram in figure 7.2 shows the function to be performed in the HLR in order to deal with the interactions with call forwarding services.

Process BI1

388_21(1)

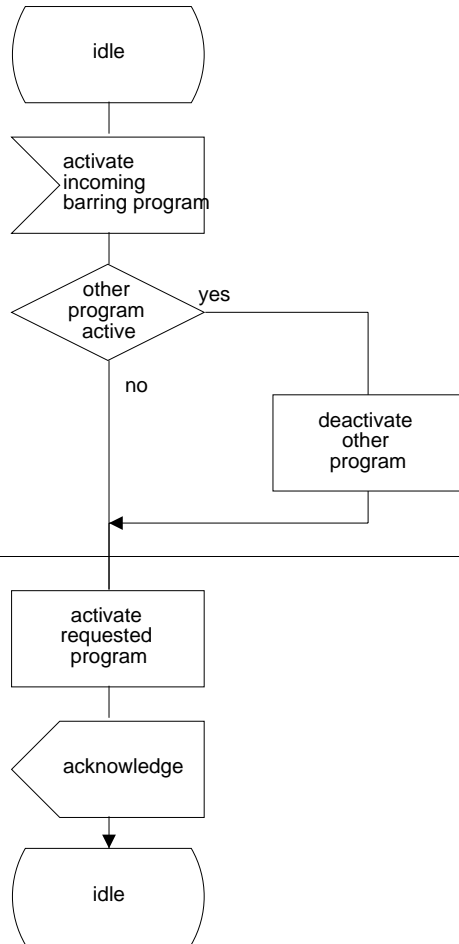

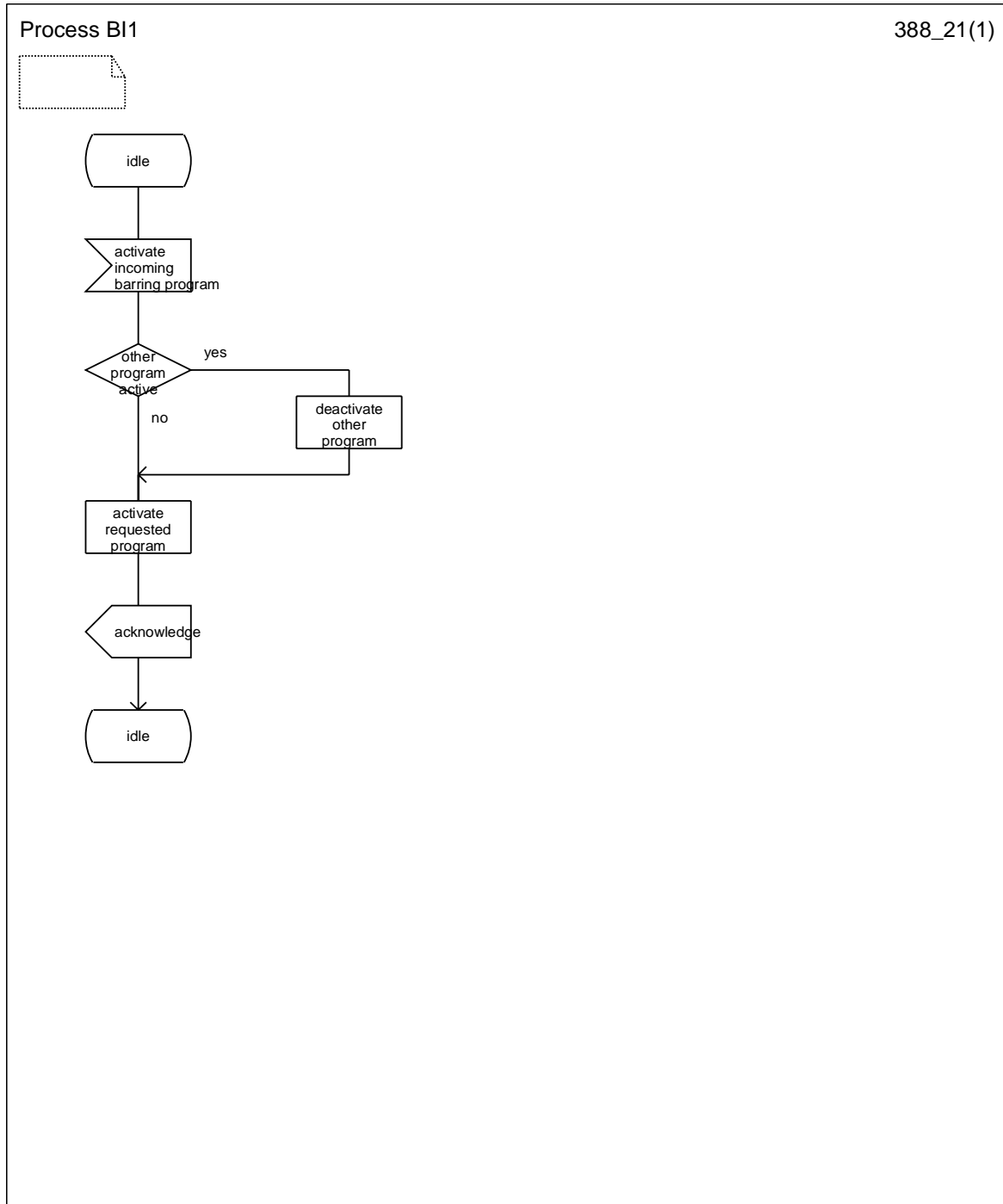
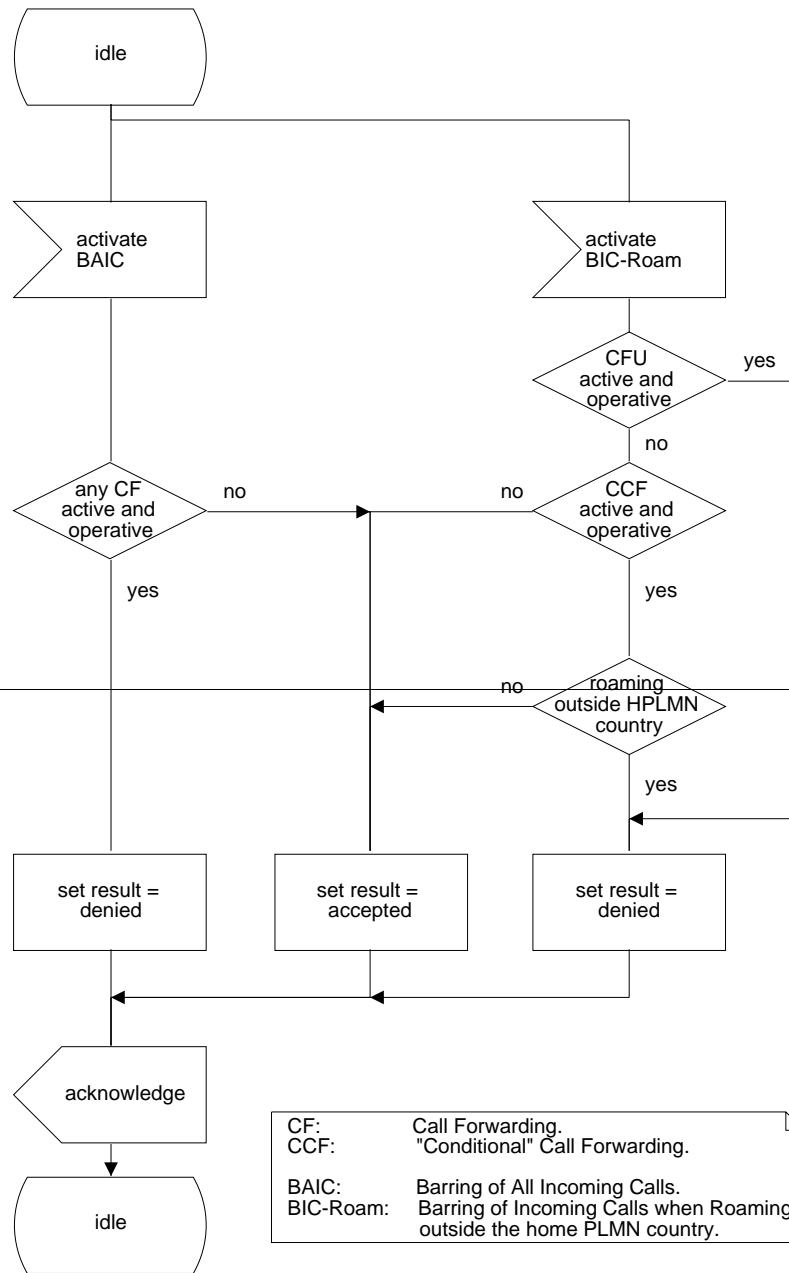

Figure 7.1: BI1 Interaction between call barring programs

Process B12

388_22(1)

Figure 2.2



CF: Call Forwarding.
CCF: "Conditional" Call Forwarding.
BAIC: Barring of All Incoming Calls.
BIC-Roam: Barring of Incoming Calls when Roaming outside the home PLMN country.

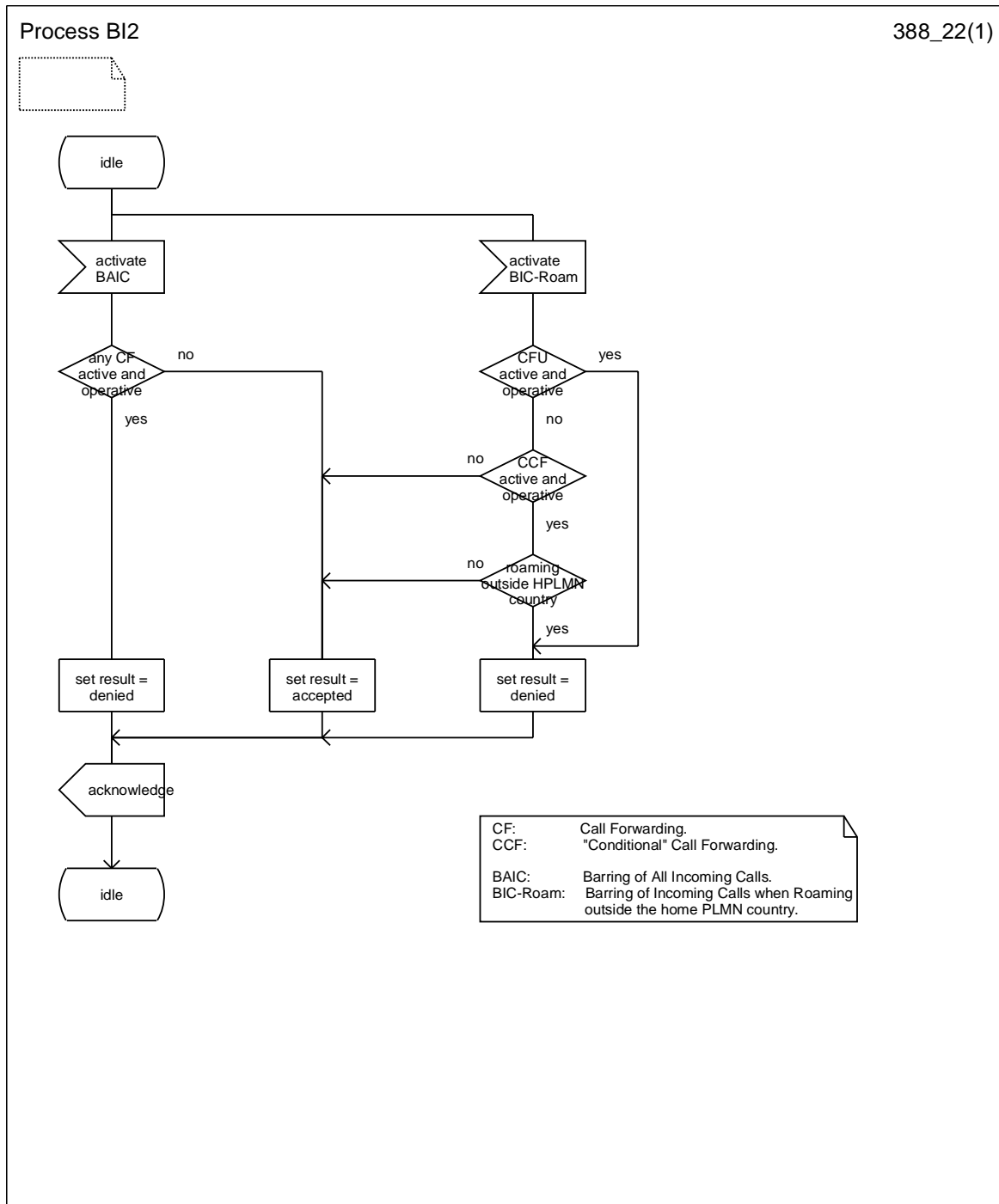
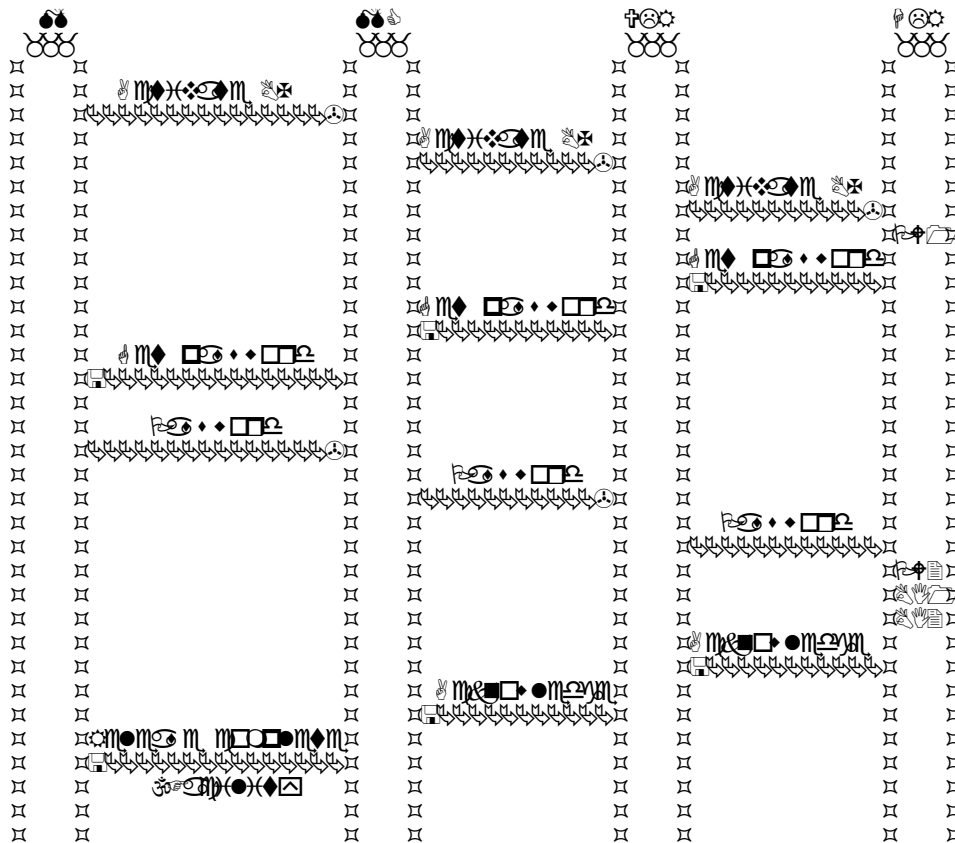

Figure 7.2: BI2 Interaction between call forwarding supplementary services and barring of incoming calls programs



NOTE: BX indicates any of the barring programs.
PW1 and PW2 indicate password handling programs, see 3G TS 23.011.

Figure 7.3: Activation of barring of incoming calls

7.1.3 Deactivation

The procedure for activation of Barring of outgoing calls, described in subclause 1.1.2.1, is valid also correspondingly for deactivation of Barring of incoming calls with the addition that a barring supplementary service, i.e. the Incoming barring service, or All barring services can be signalled.

The information flow for deactivation of barring of incoming calls is shown in figure 7.4. For more details see 3G TS 23.011.

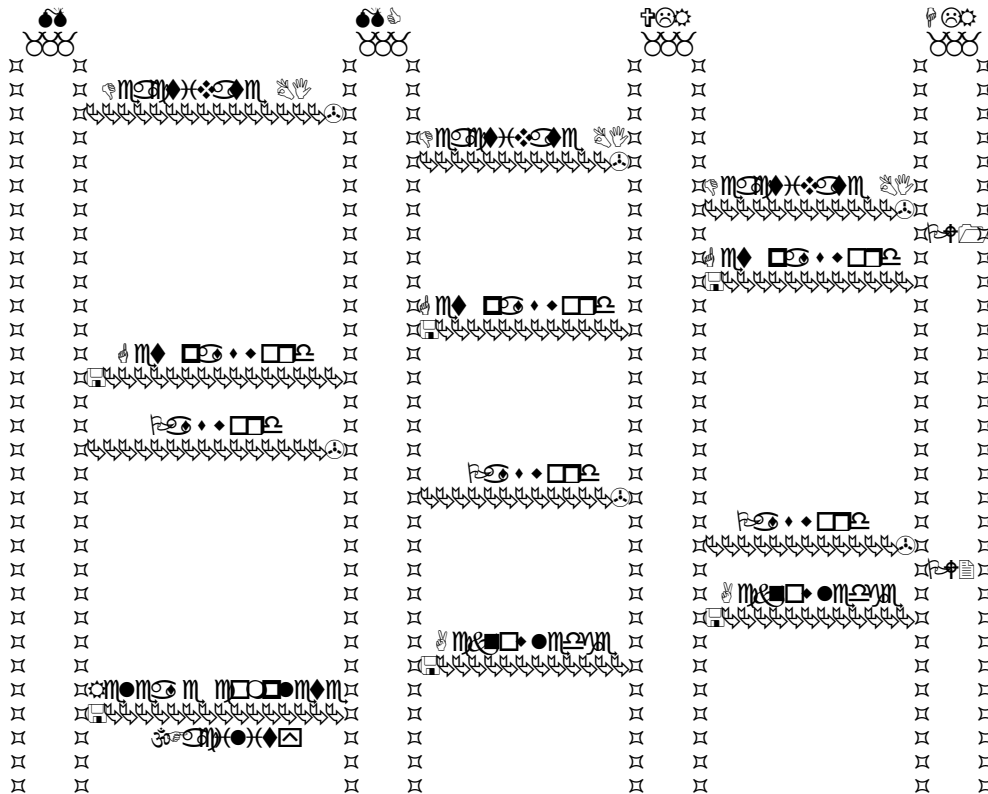

NOTE: BI indicates the general code for barring of incoming calls.
 PW1 and PW2 indicate password handling programs, see 3G TS 23.011.

Figure 7.4: Deactivation of barring of incoming calls

7.1.4 Interrogation

The interrogation procedure enables the mobile subscriber to obtain information about the data stored in the PLMN. After having requested this procedure the network shall return a list of all basic services to which the given program is active.

The information flow for interrogation of barring of incoming calls is shown in figure 7.5.

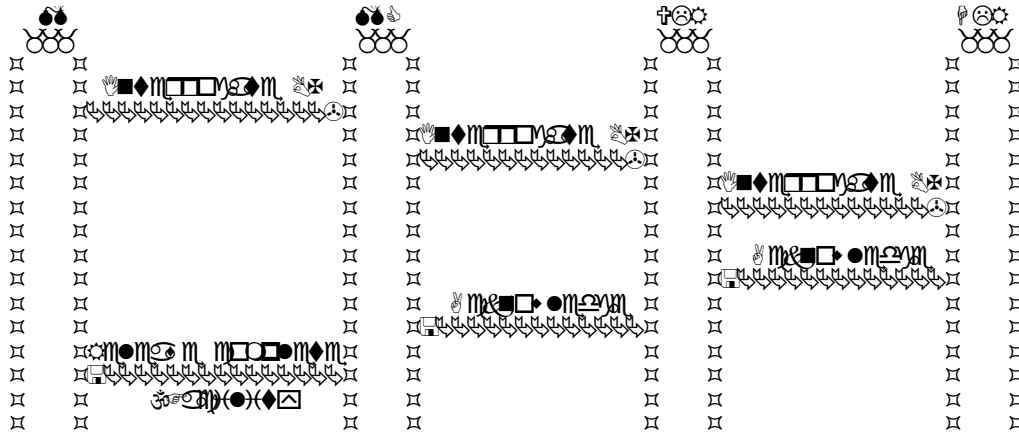

NOTE: BX indicates any of the barring programs.

Figure 7.5: Interrogation of barring of incoming calls

7.2 Functions and information flows

The following Mobile Additional Functions have been identified:

MAF022

Barring of all incoming calls related authorizations examination

The ability of a PLMN component to determine the authorizations relating to barring of incoming calls. See figure 7.6.

Location: HLR

MAF023

Barring of incoming calls when roaming outside the home PLMN country related authorizations examination

The ability of a PLMN component to determine the authorizations relating to barring of incoming calls when roaming outside the home PLMN country. See figure 7.7.

Location: HLR

The information flow for barring of incoming calls is shown in figure 7.8.

Process MAF022

388_26(1)

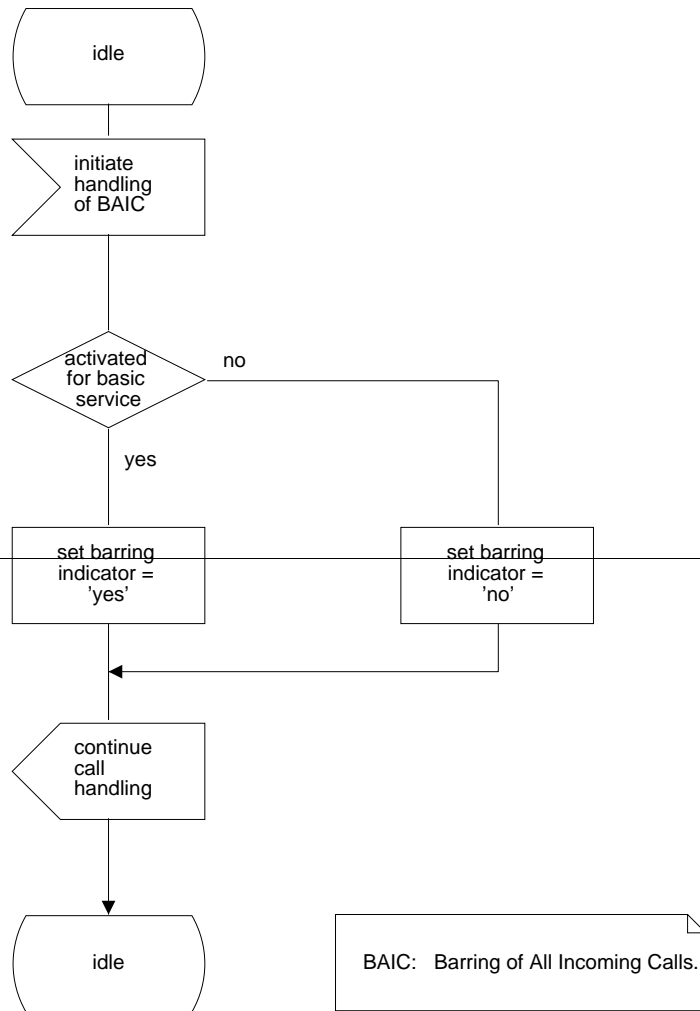

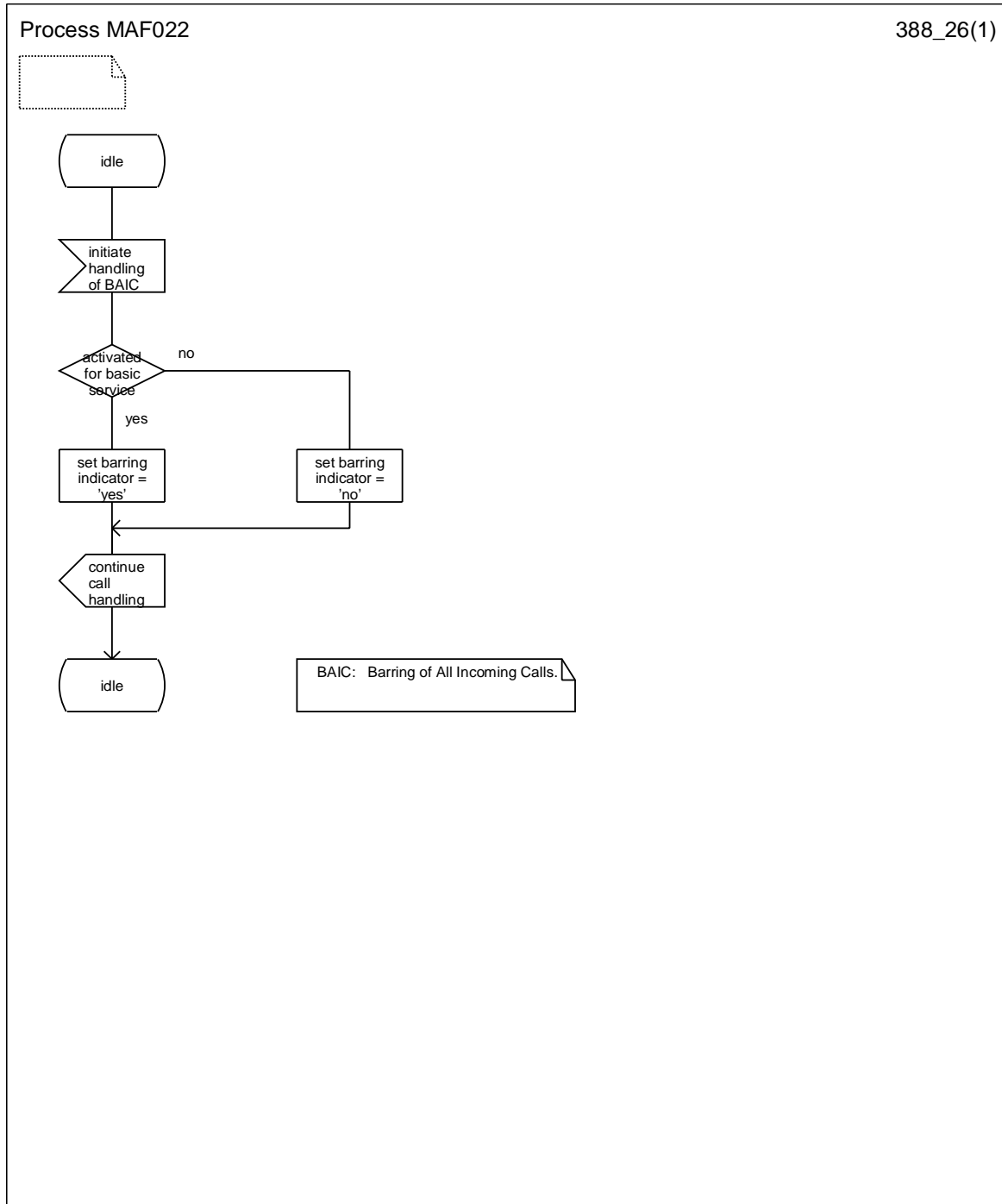
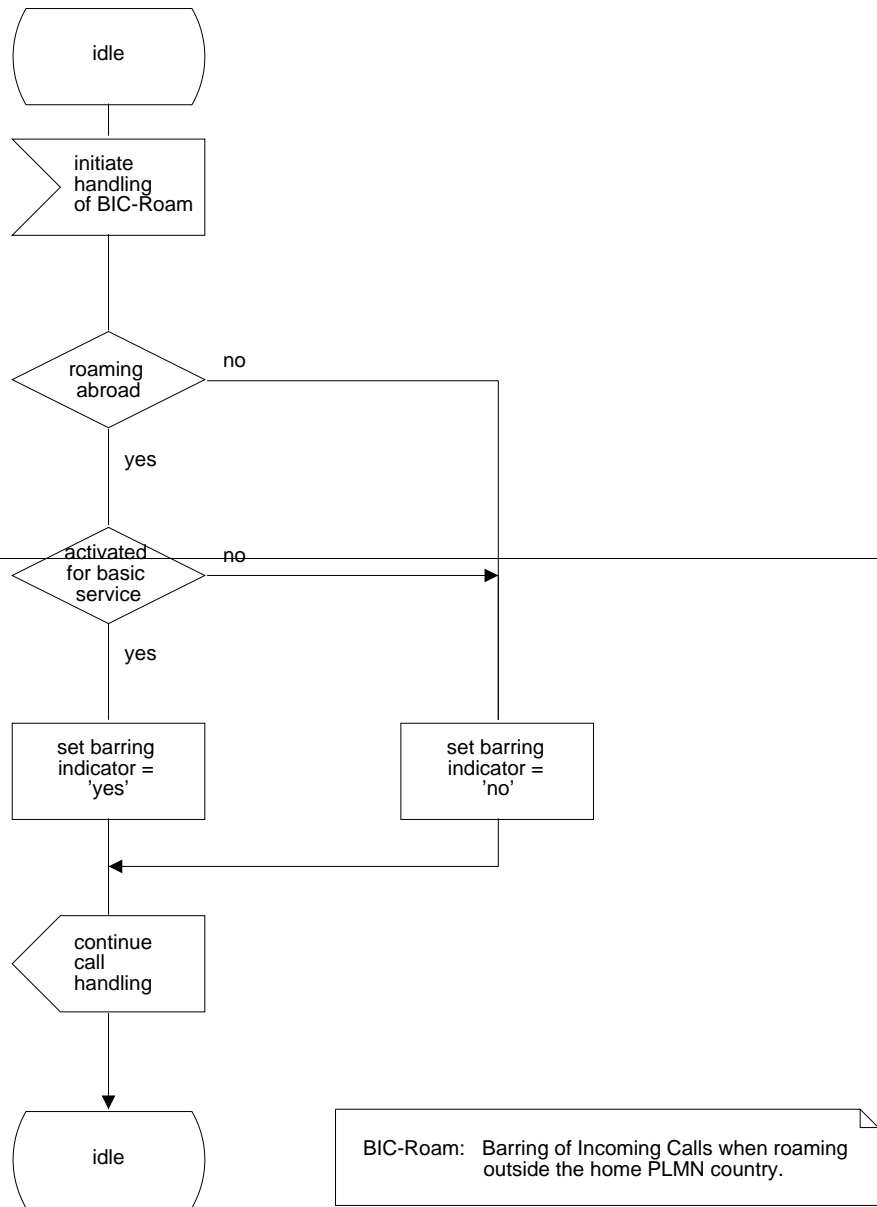

Figure 7.6: MAF022 Barring of all incoming calls related authorisations examination (HLR)

Process MAF023

388_27(1)



Process MAF023

388_27(1)

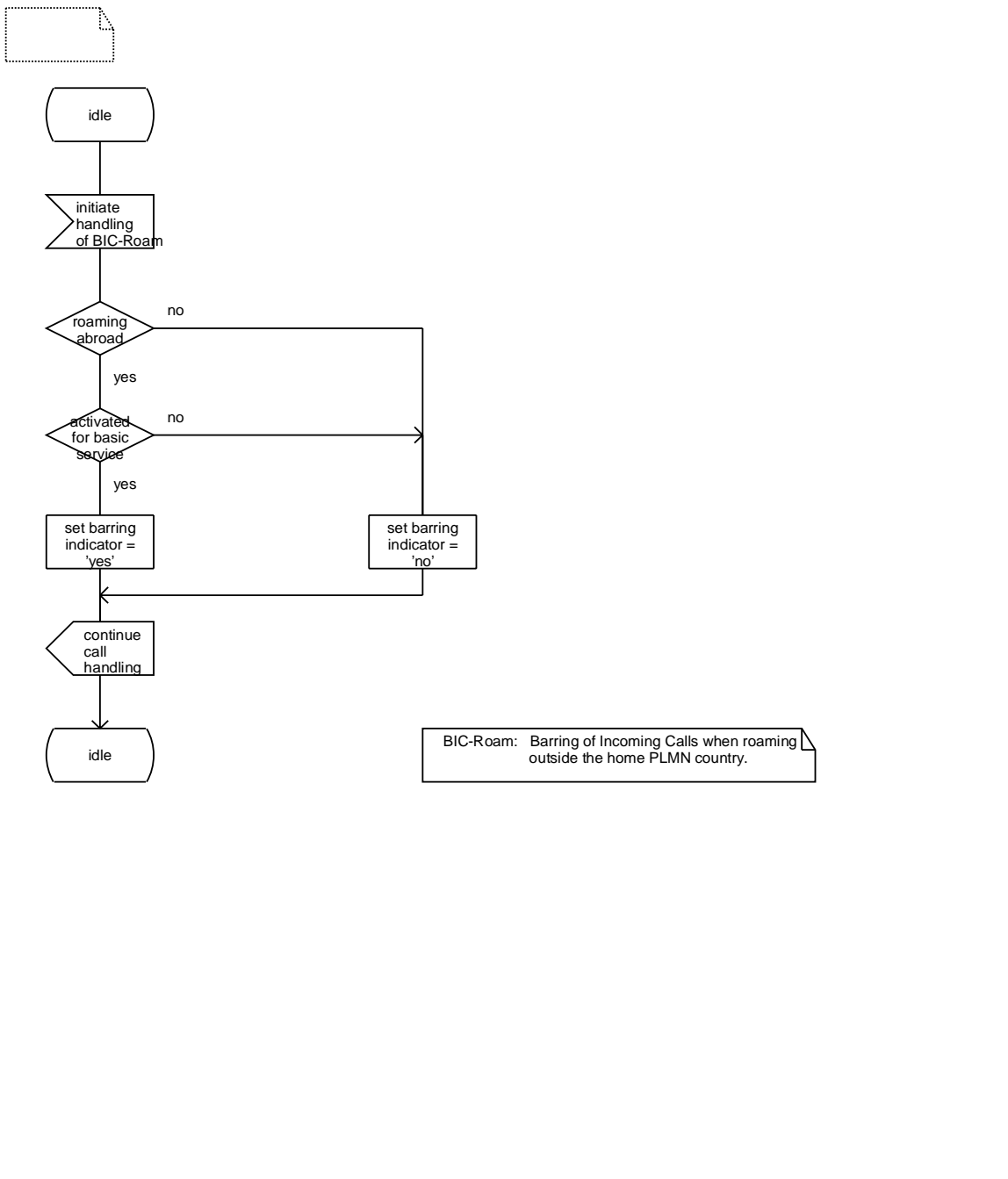

Figure 7.7: MAF023 Barring of incoming calls when roaming outside the home PLMN country related authorisations examination (HLR)

5.2.5 Handling of unstructured SS operation at the MS

The MS may at any time receive a USSD operation (request or notification) from the MSC.

If the MS receives a USSD transaction while another USSD transaction (network or mobile initiated) or a non-call related supplementary service transaction is in progress, the MS shall reject the new transaction.

If the MS receives a USSD operation when it is in a state where the MMI required is not possible (e.g. during dialling) it shall reject the operation.

If the MS does not support the alphabet indicated in the USSD operation, it shall inform the network.

If the MS is in a state where it can handle the operation, it shall process the operation as follows:

- The MS shall analyse the data coding scheme and decides whether the USSD operation is MMI mode or application mode, . See GSM 02.30 for details of codes

If the data coding scheme corresponds to the MMI mode :

- For a USSD request, the MS shall display the text provided and await user input. If the user enters a response, the MS shall return the response to the MSC, maintaining the transaction. If the user requests release of the transaction, the MS shall release the transaction.
- For a USSD notification, the MS shall display the text provided and send back a response.

If the data coding schemes corresponds to the application mode :

- For a USSD request, the MS shall pass the message to the application addressed in the ME, SIM or TE, and await application response . If the application responds, the MS shall pass the response to the MSC, maintaining the transaction. If the application releases the transaction, the MS shall release the transaction.
- For a USSD notification, the MS shall pass the message to the application addressed in the ME, SIM or TE, and send back a response.

After sending the response to a USSD operation, the MS shall wait for the network to release the transaction. If, while awaiting this release, the MS receives any further USSD operations, it shall process them in the normal way.

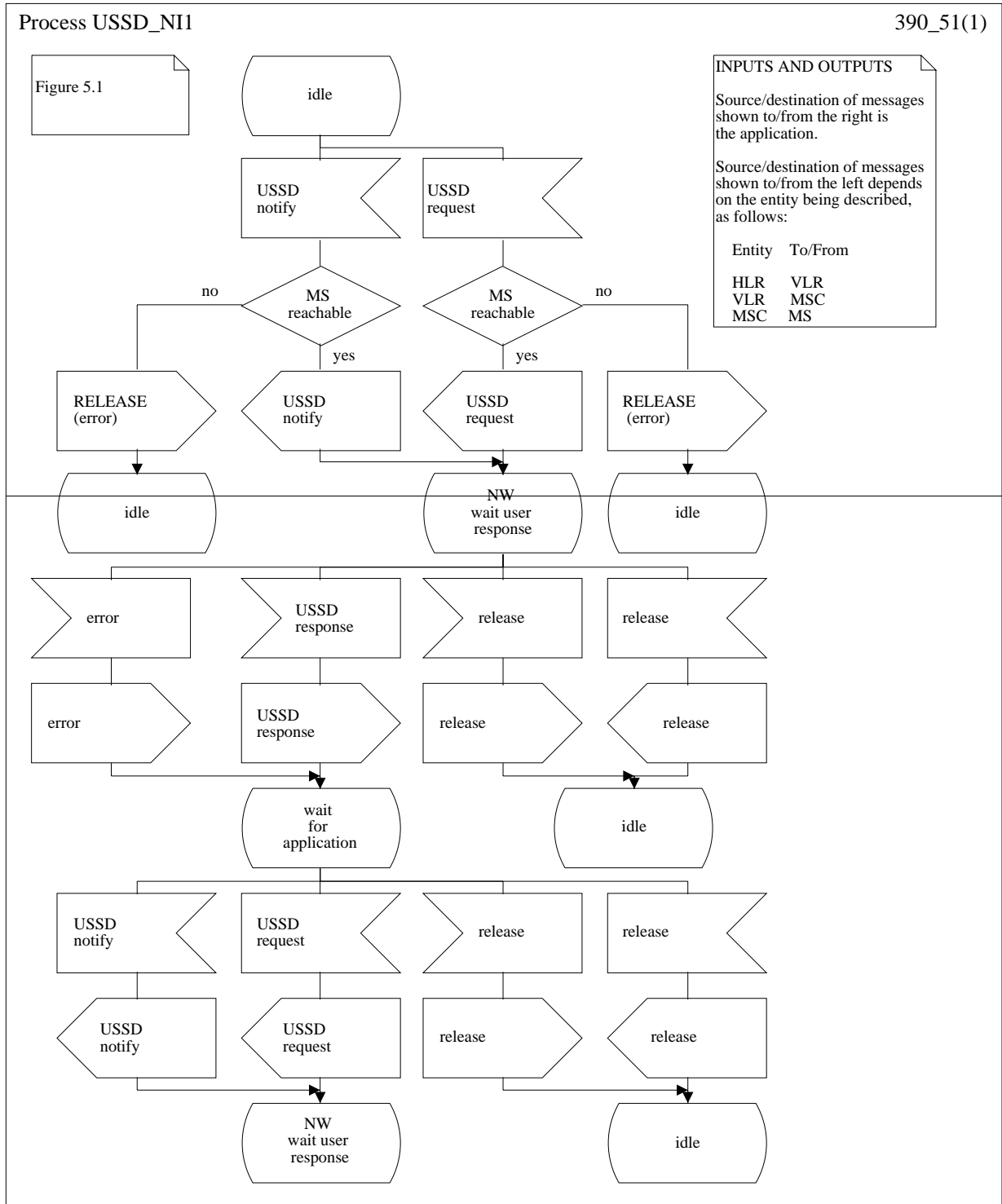

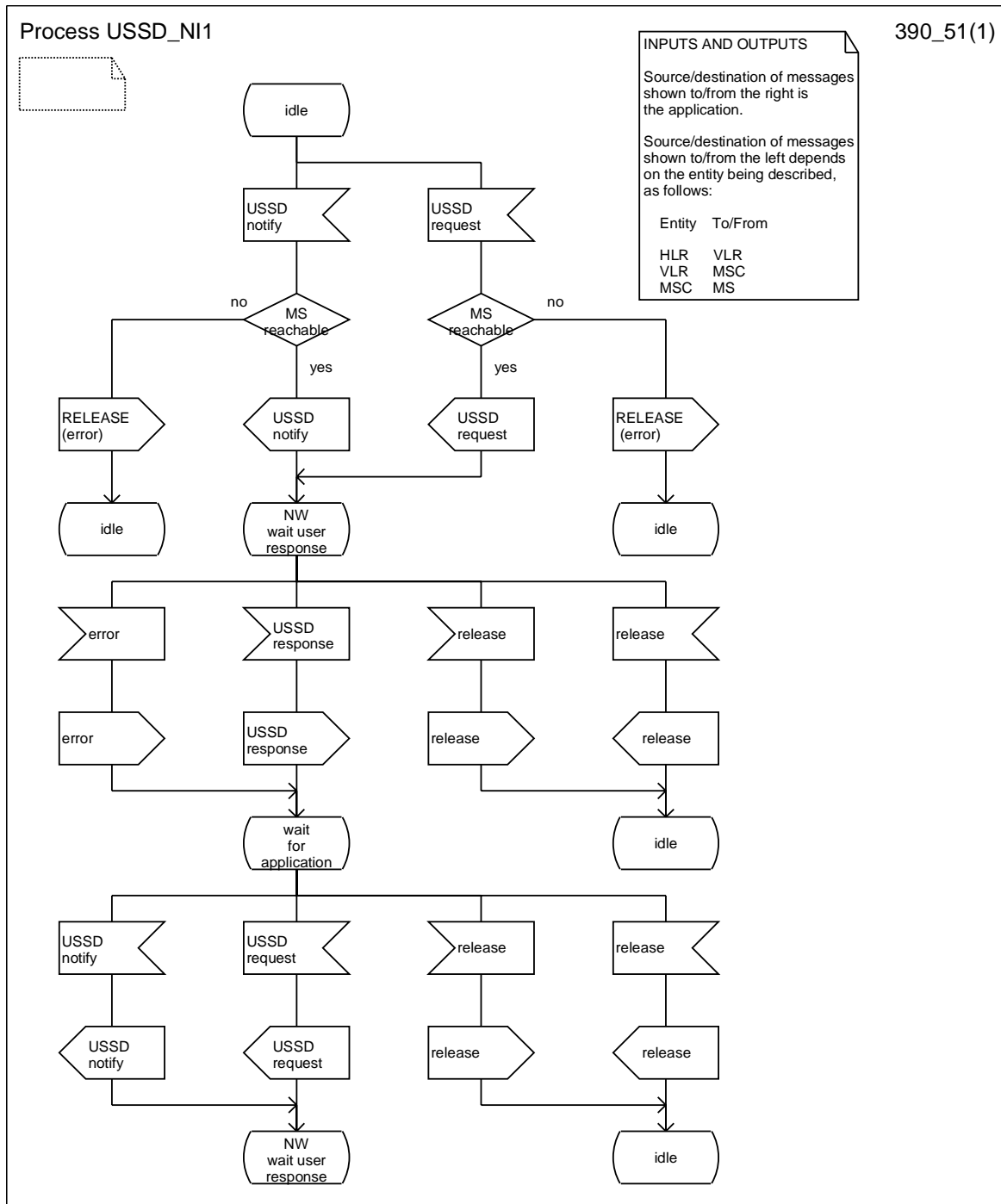

Figure 5.1: Network initiated USSD invoked at HLR, VLR or MSC

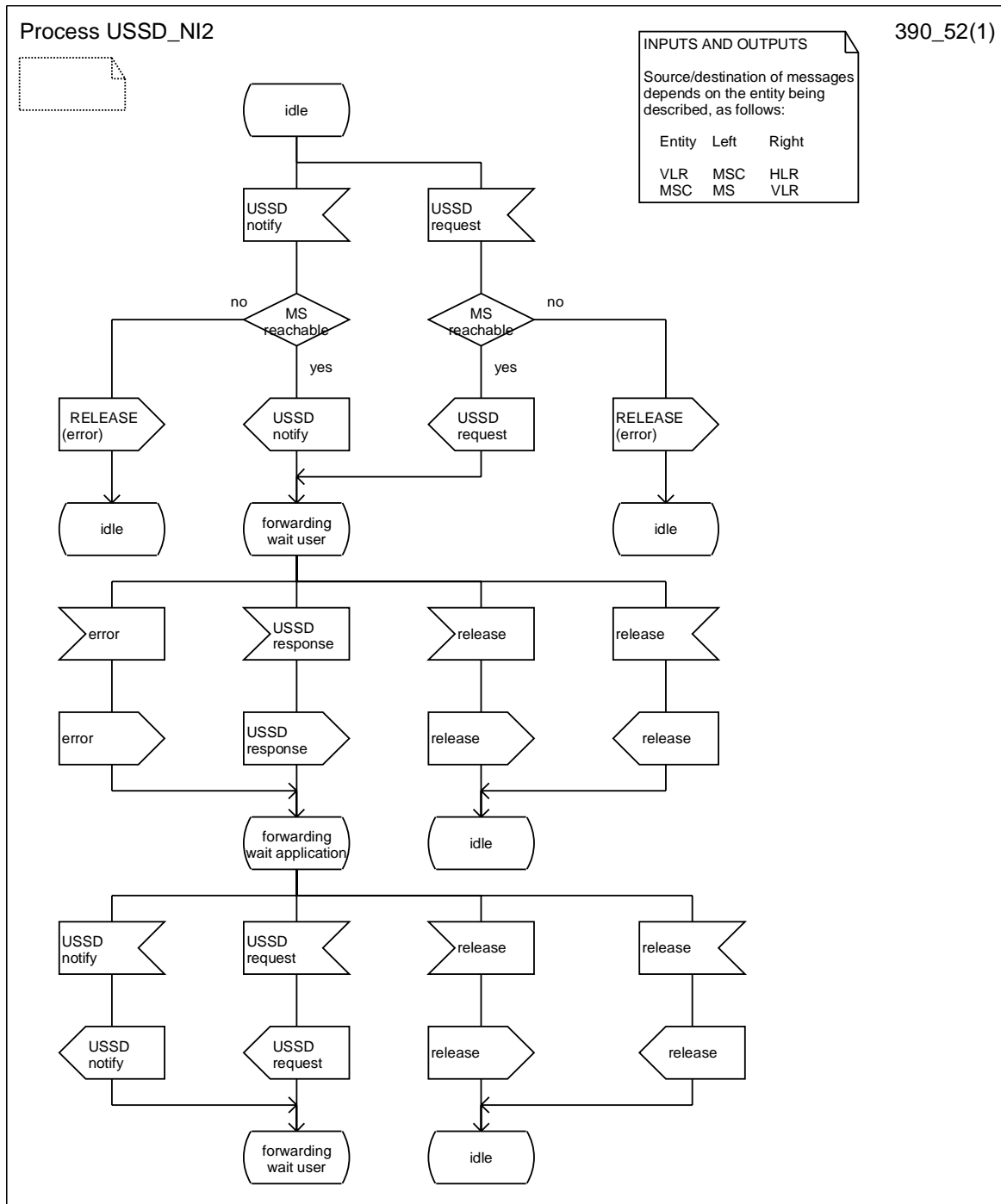

Figure 5.2: Network initiated USSD forwarding at VLR or MSC

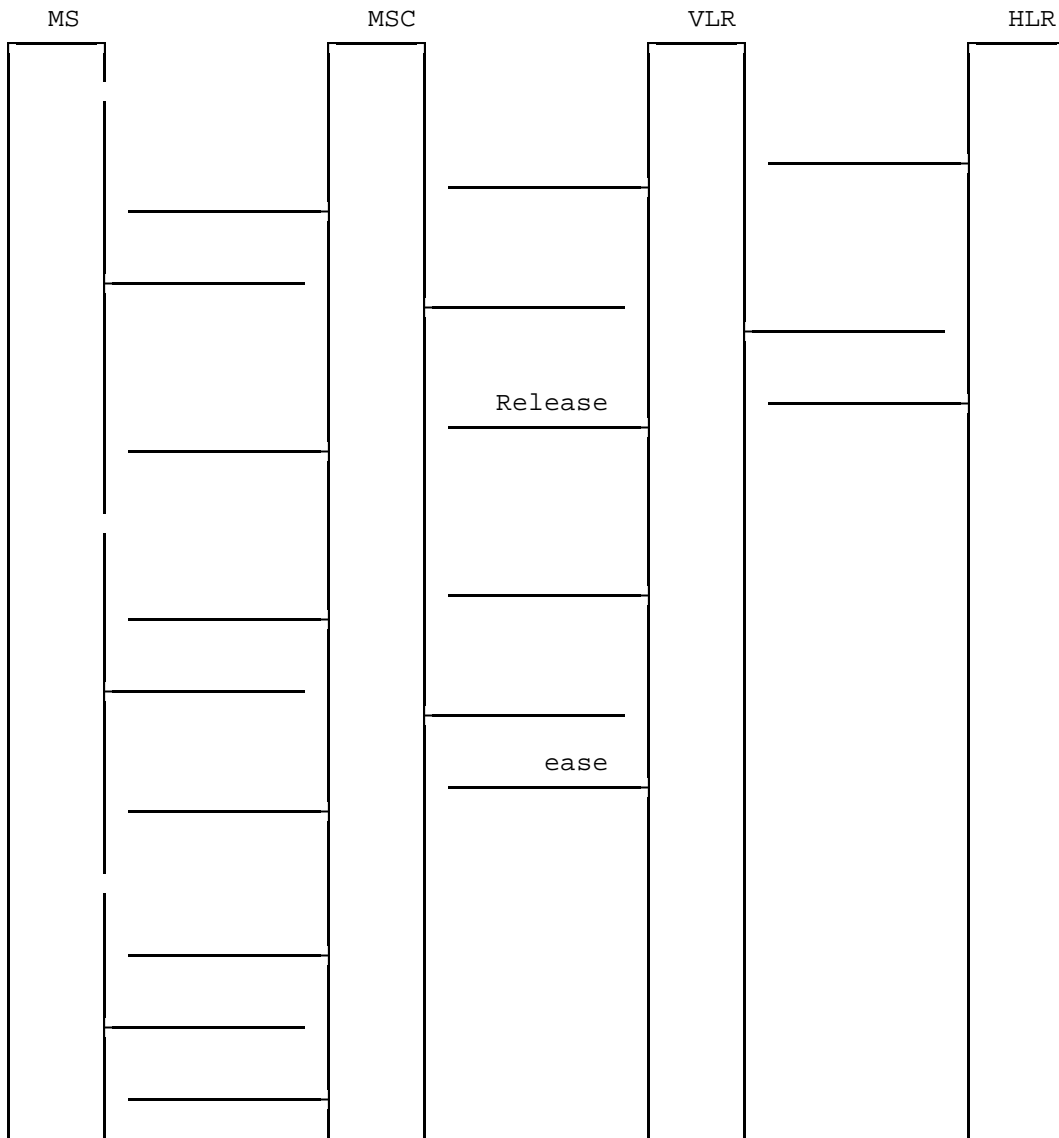

Figure 5.4: Information flow for USSD request (Single Operation)

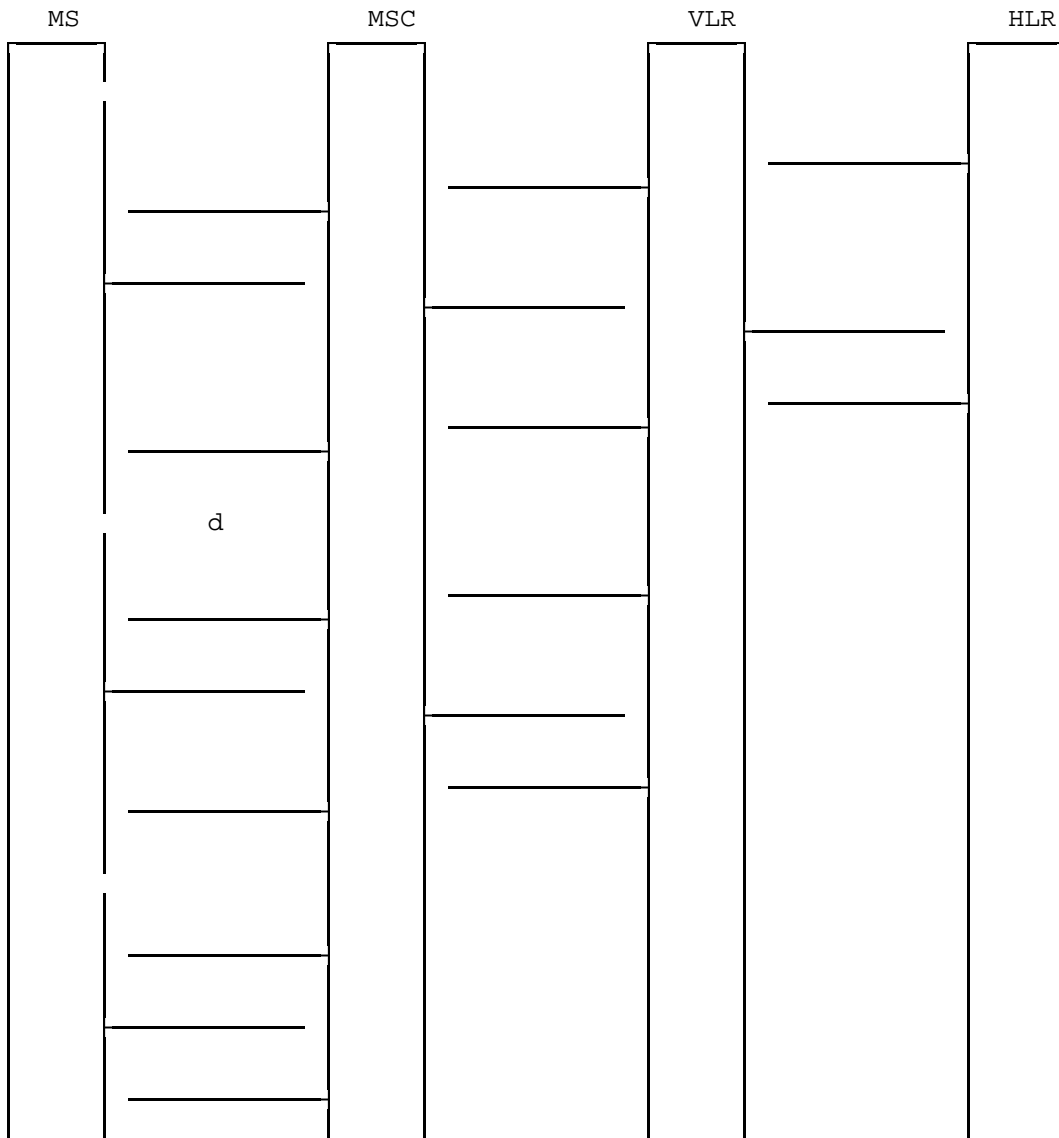

Figure 5.5: Information flow for USSD notification (Single Operation)

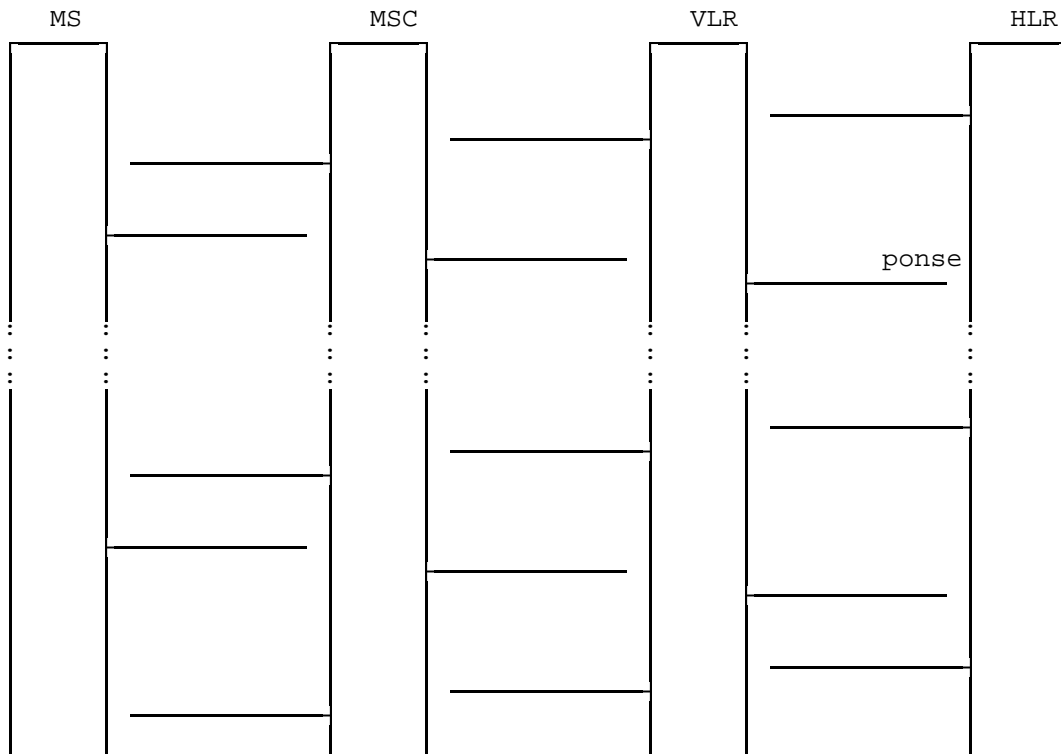

Figure 5.6: Information flow for HLR initiated USSD request (Multiple Operation On Same Transaction)

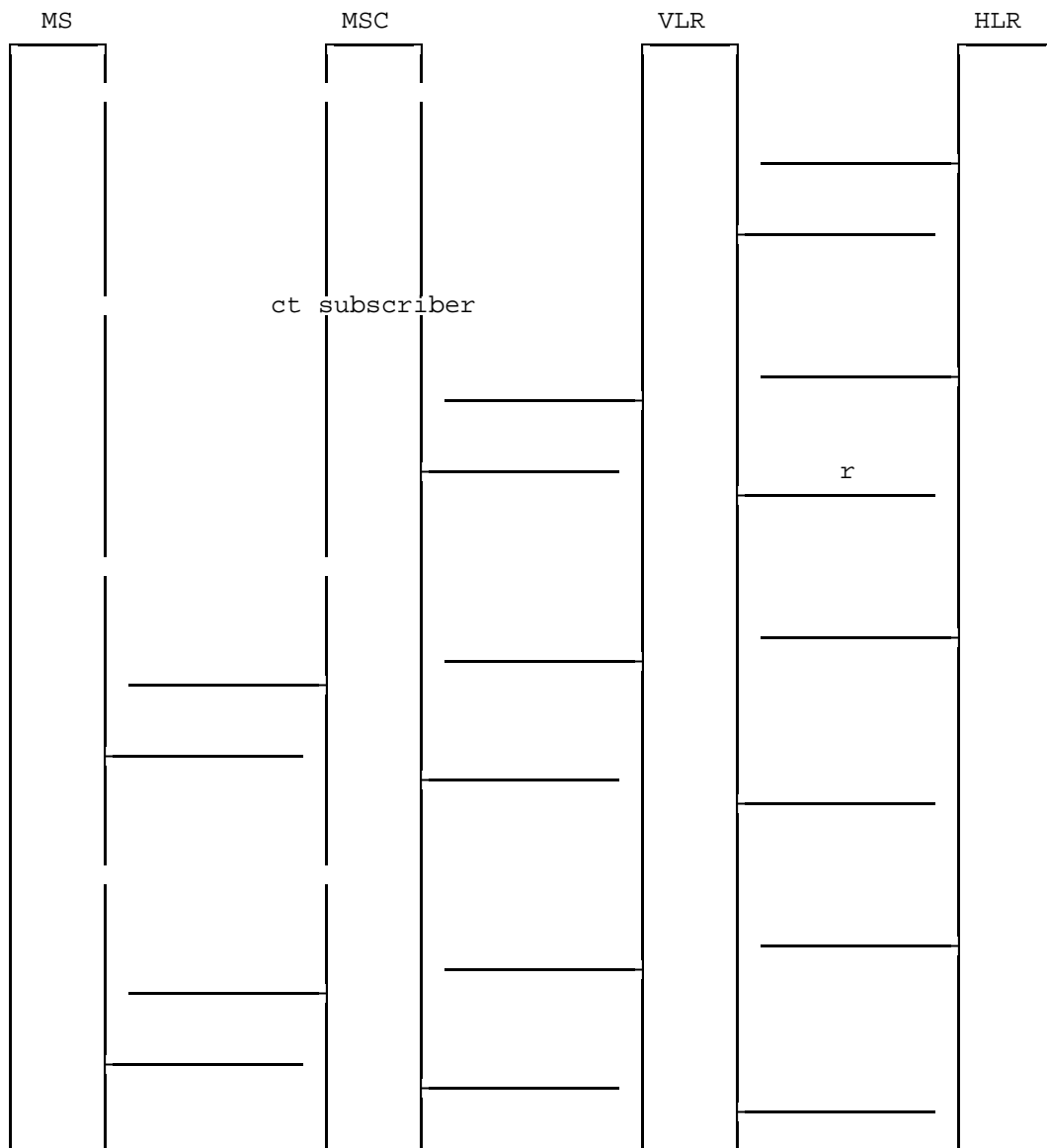

Figure 5.7: Information flow for failed USSD request

5.3 Information stored in the HLR

The HLR shall not store any information specific to the use of USSD, although information may be stored for services which are offered by USSD applications.

5.4 Information stored in the VLR

The VLR shall not store any information specific to the use of USSD, although information may be stored for services which are offered by USSD applications.

5.5 Handover

Handover will have no impact on the operation of this service.

5.6 Cross-phase compatibility

Network initiated USSD shall not be permitted if the MS or any network entity involved in the operation is of Phase 1. If, when setting up a transaction, a network entity discovers that the other end is of Phase 1, it shall reject the request and release the transaction being set up.

6 Mobile initiated unstructured supplementary service data

6.1 Handling of mobile initiated USSD

A MS can at any time initiate a USSD request to the network. No prior provision of the service is required, although provisioning of services which make use of USSD may be required. All USSD messages (requests and responses), contain the USSD string, an alphabet indicator and language indicator.

6.2 Functions and information flows

The following text describes the handling of mobile network initiated USSD. Diagrammatic representations are as follows:

- Figure 6.1 SDL, request from user at MS;
- Figure 6.2 SDL, request from MS at MSC;
- Figure 6.3 SDL, request from application at MSC;
- Figure 6.4 SDL, request from MSC at VLR;
- Figure 6.5 SDL, request from application at VLR;
- Figure 6.6 SDL, request from VLR at HLR;
- Figure 6.7 Information flow, no further information required;
- Figure 6.8 Information flow, further information required;
- Figure 6.9 Information flow for failed USSD request.

6.2.1 Handling of USSD request at MS

When the user or the application in the MS makes a request which the MS determines is to make use of USSD, the MS shall set up a transaction to the network, send the request to the MSC and await a response. When the MS receives the response, it shall display the information contained to the user or relay the message to the application in the MS.

While awaiting the response, the MS may receive a network initiated USSD request or notification on the same transaction. If this occurs, the MS shall process that operation (see section 1) and continue to await the response to the mobile initiated request.

If, when the MS determines that a user request is to make use of USSD, the MS is already involved in a USSD or a non-call related supplementary service transaction, the MS shall reject the request.

6.2.2 Handling of USSD request at MSC

When an MSC receives a USSD request containing an HPLMN service code, it shall set up a transaction to the VLR and forward the request unchanged. If this forwarding fails, an error shall be returned to the MS. The MSC shall be transparent to any further requests or responses (in either direction) for that transaction, passing them between the MS and VLR without taking any action. When one transaction is released (MS-MSC or MSC-VLR), the MSC shall release the other.

If an HPLMN service code is not included, the MSC shall process the request locally (see section 6.2.5).

If the MSC does not support the alphabet used in a USSD request, it shall set up a transaction to the VLR and forward the request unchanged, in the same way as when a HPLMN service code is received.

6.2.3 Handling of USSD request at VLR

When a VLR receives a USSD request containing an HPLMN service code and the user is not in the HPLMN, it shall set up a transaction to the HLR and forward the request unchanged. If this forwarding fails, an error shall be returned to the MS. The VLR shall be transparent to any further requests or responses (in either direction) for that transaction, passing them between the MSC and HLR without taking any action. When one transaction is released (MSC-VLR or VLR-HLR), the VLR shall release the other.

If an HPLMN service code is not included, or the user is in the HPLMN, the VLR shall process the request locally (see subclause 6.2.5).

If the VLR does not support the alphabet used in a USSD request, it shall set up a transaction to the HLR and forward the request unchanged, in the same way as when a HPLMN service code is received and the user is not in the HPLMN.

6.2.4 Handling of USSD request at HLR

An HLR shall always process a USSD request locally (see subclause 6.2.5).

If the HLR does not support the alphabet used in a USSD request, it shall inform the MS and release the transaction.

6.2.5 Processing the USSD request

When a network entity is to process a USSD request locally, the request shall be handled by an appropriate application. The location, nature and contents of USSD applications is, by definition, service provider and network operator dependent, but may include:

- Setting up or releasing signalling and/or speech channels;
 - Passing the request to another network entity (unchanged or changed);
 - Passing a different USSD request to another network entity;
- and/or
- Requesting further information from the MS (one or more times).

Upon completion of handling the request, the network entity shall respond to the request and release the transaction.

Process USSD_MI1

390_61(1)

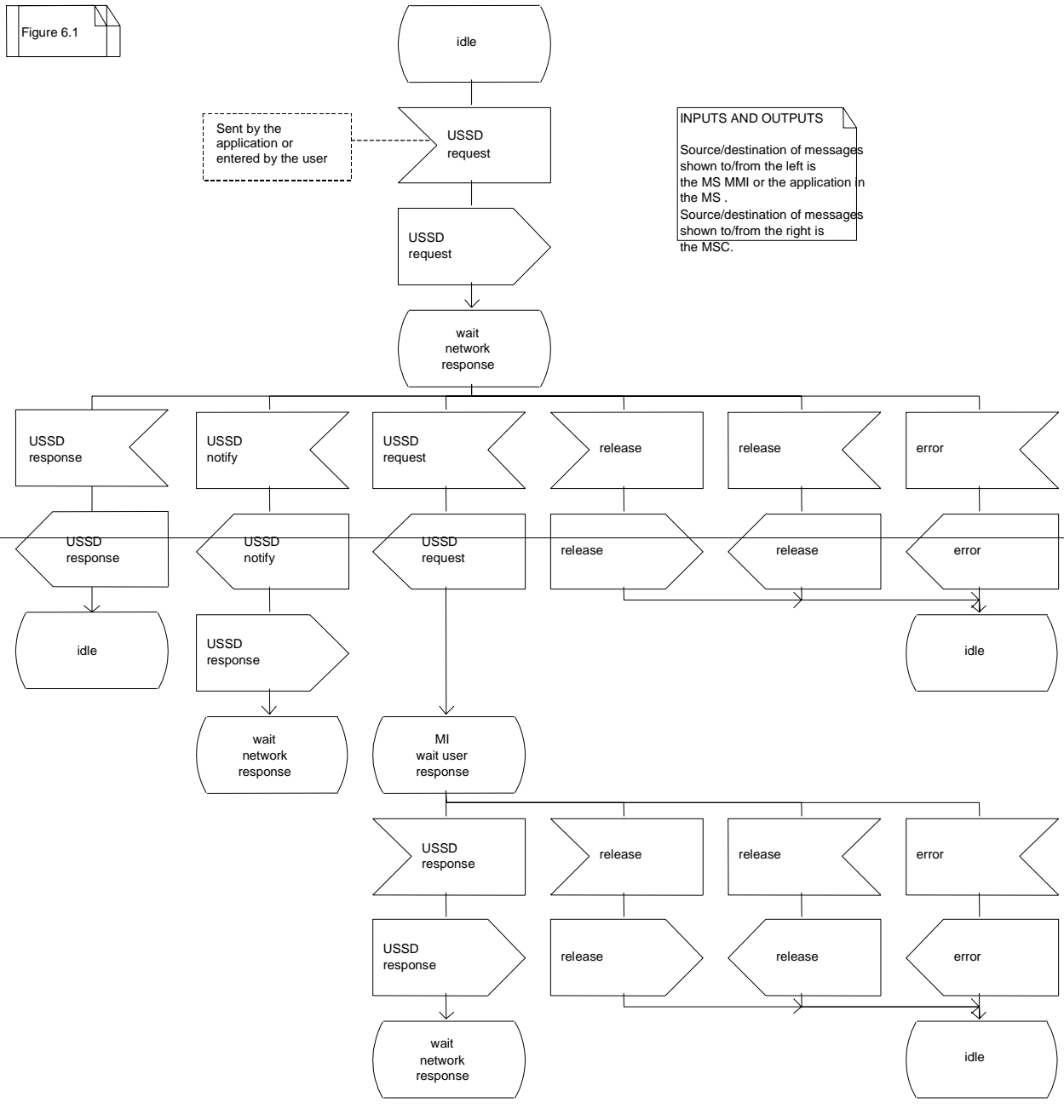

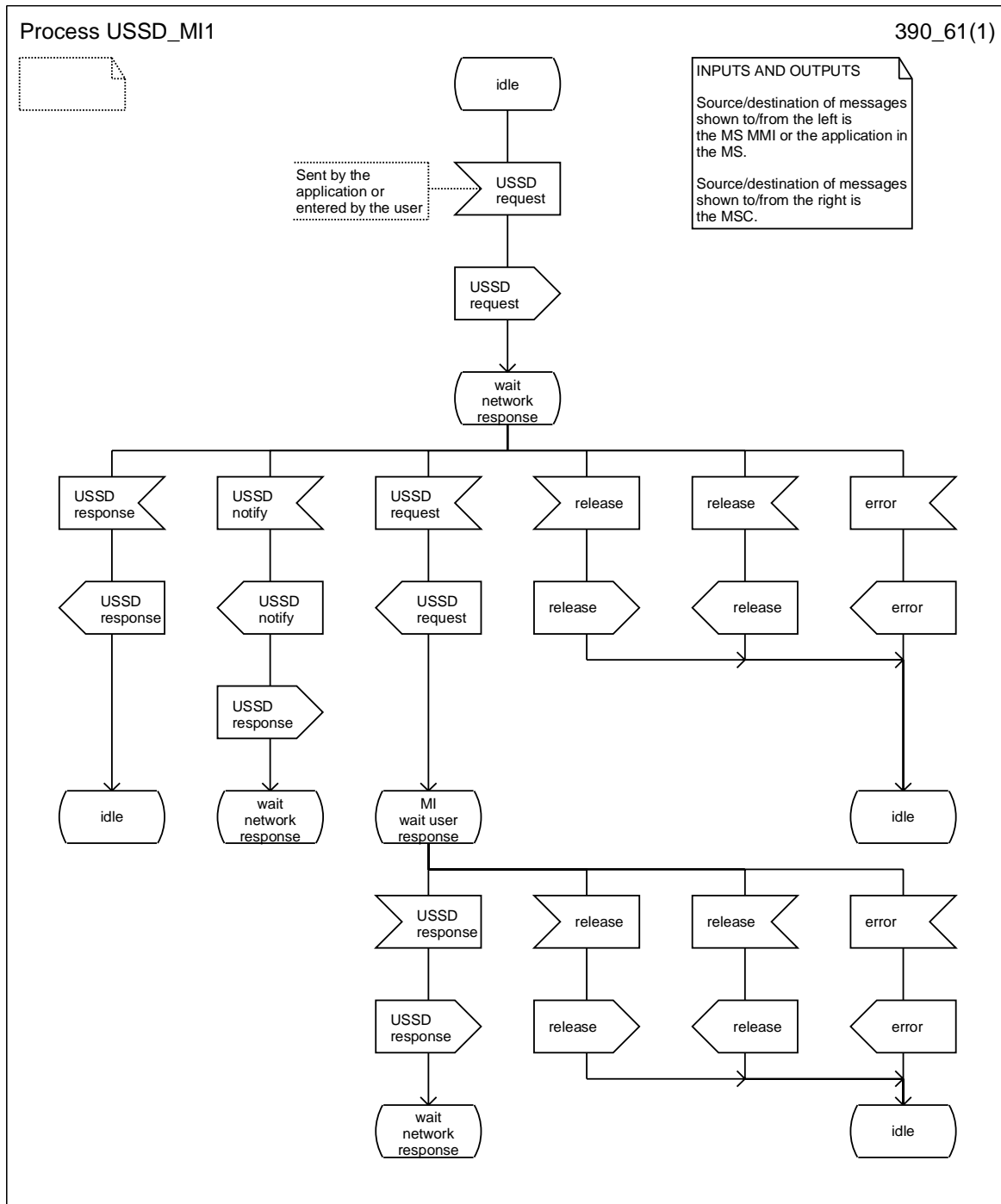

Figure 6.1: Mobile initiated USSD at MS

Process USSD_MI2

390_621(3)

Figure 6.2 (sheet 1 of 3)

INPUTS AND OUTPUTS

Source/destination of messages shown to/from the left is the MS.

Source/destination of messages shown to/from the right is either the VLR or the application (as indicated).

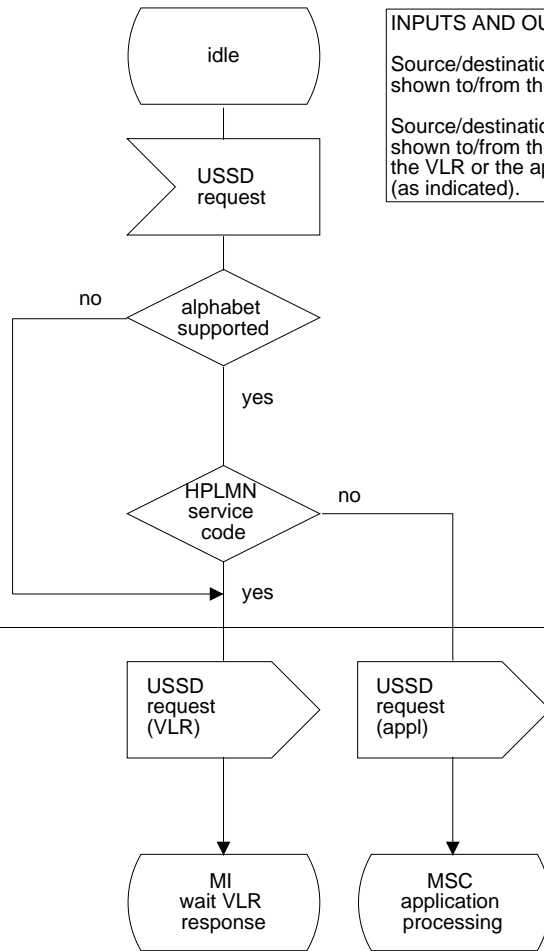

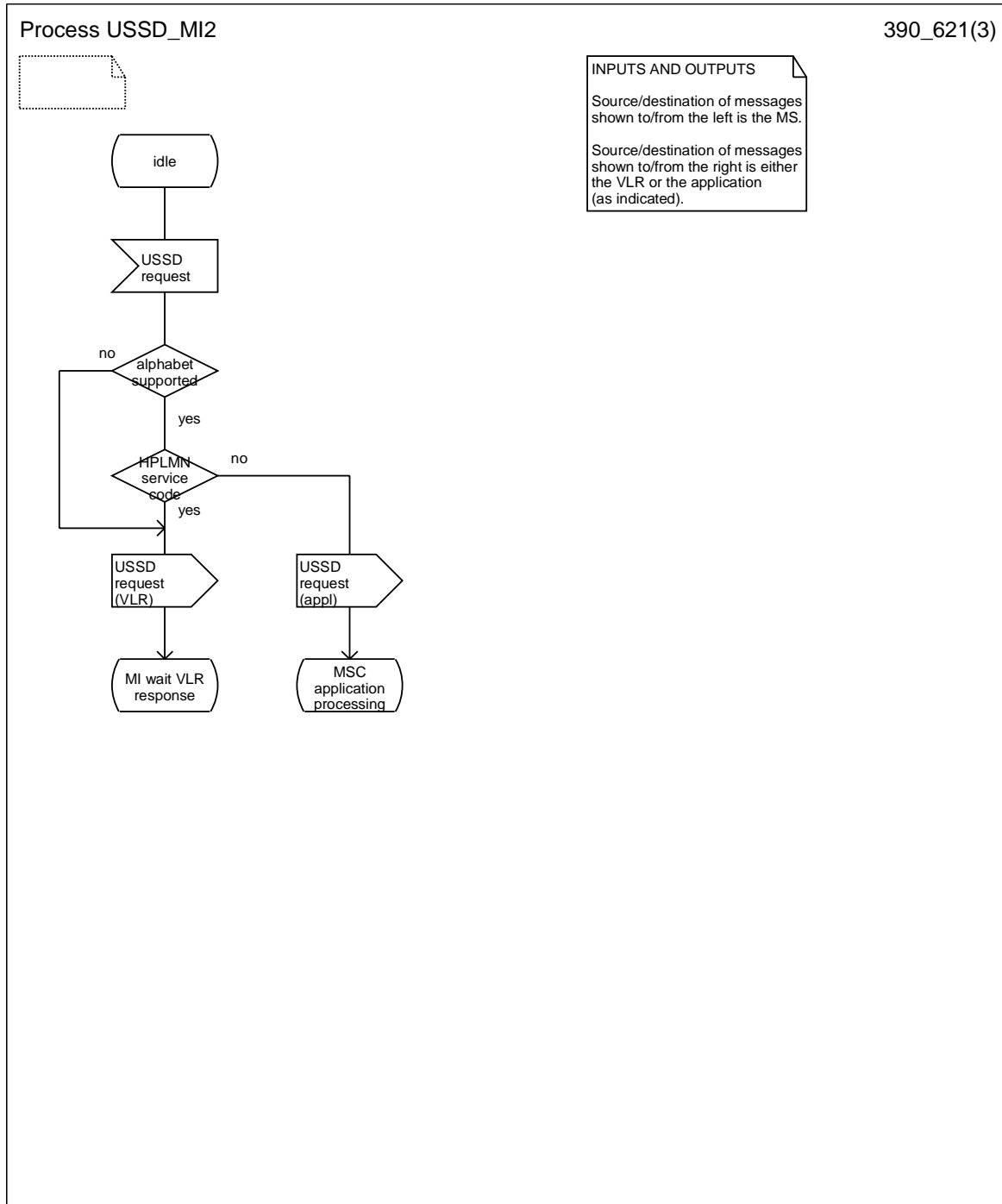
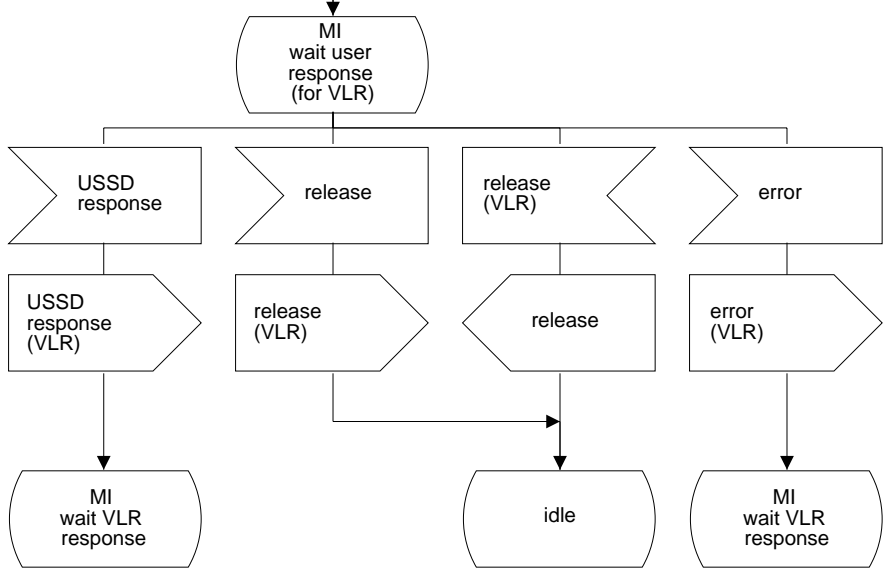
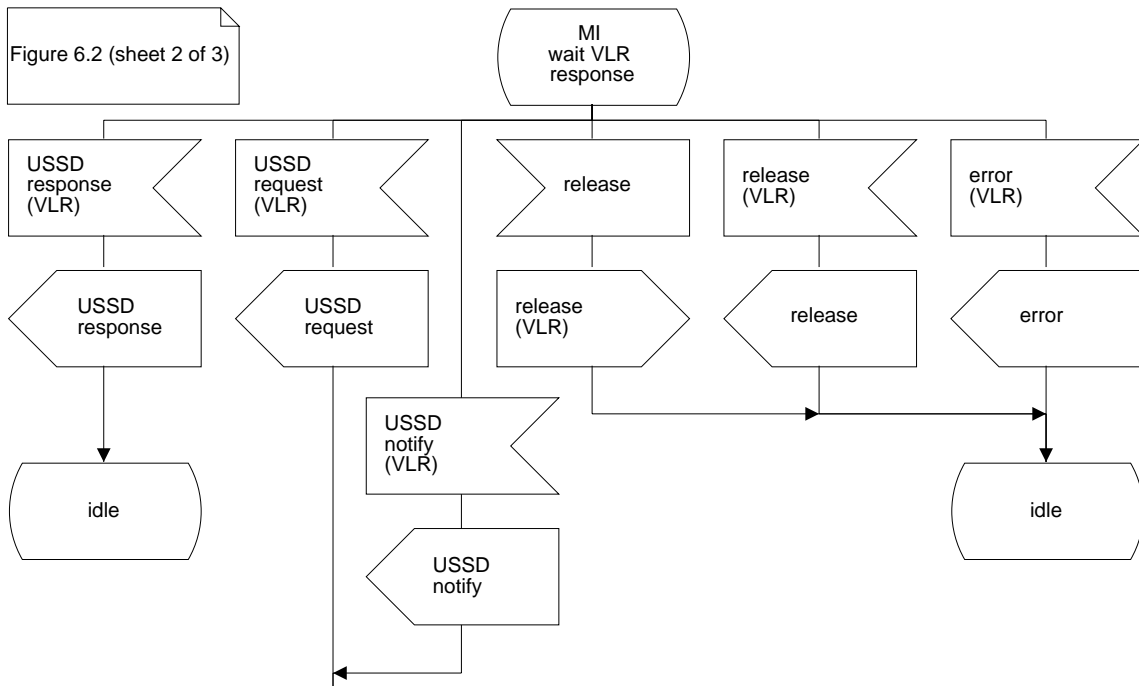

Figure 6.2 (sheet 1 of 3): Mobile initiated USSD at MSC

Process USSD_MI2

390_622(3)



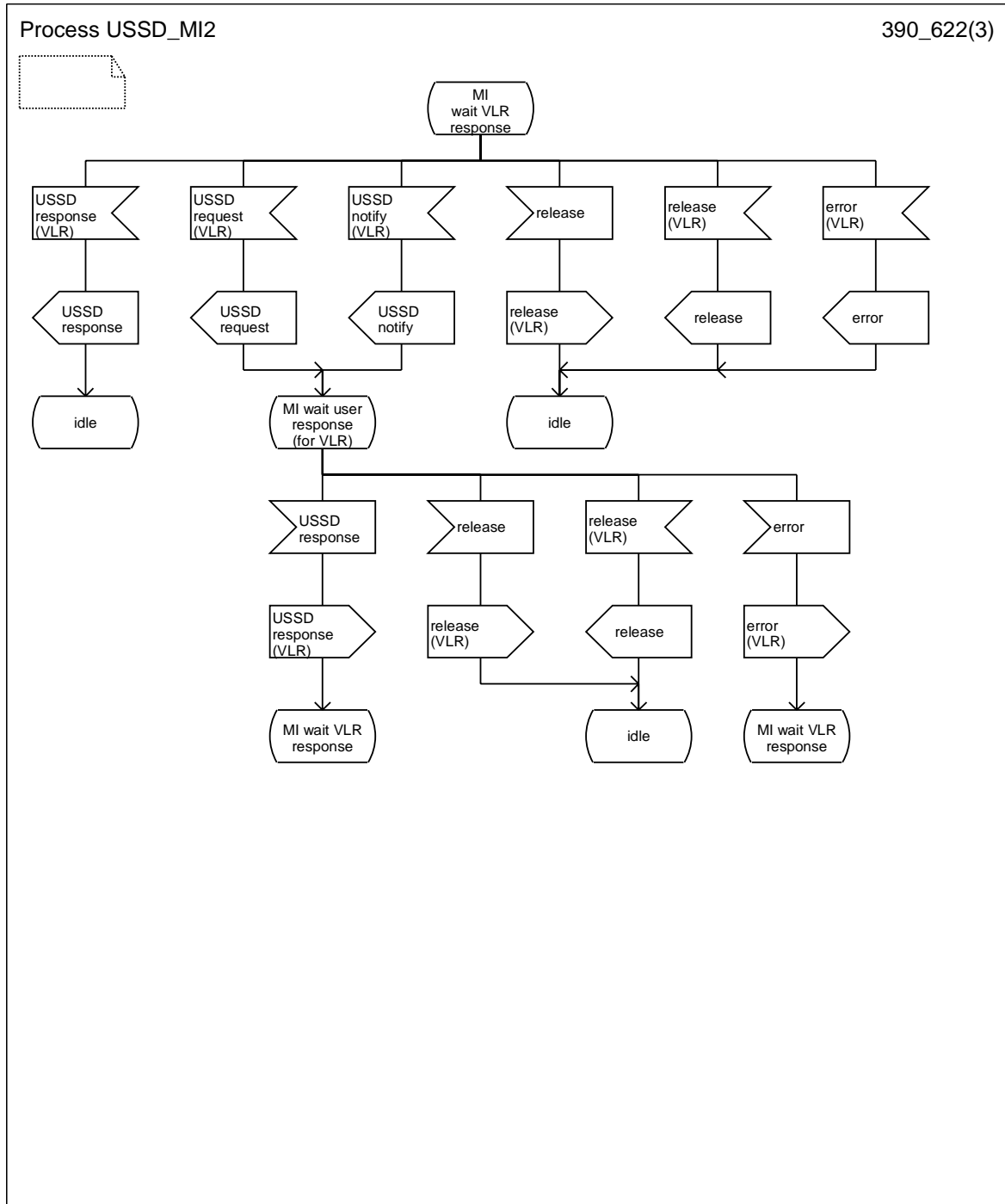
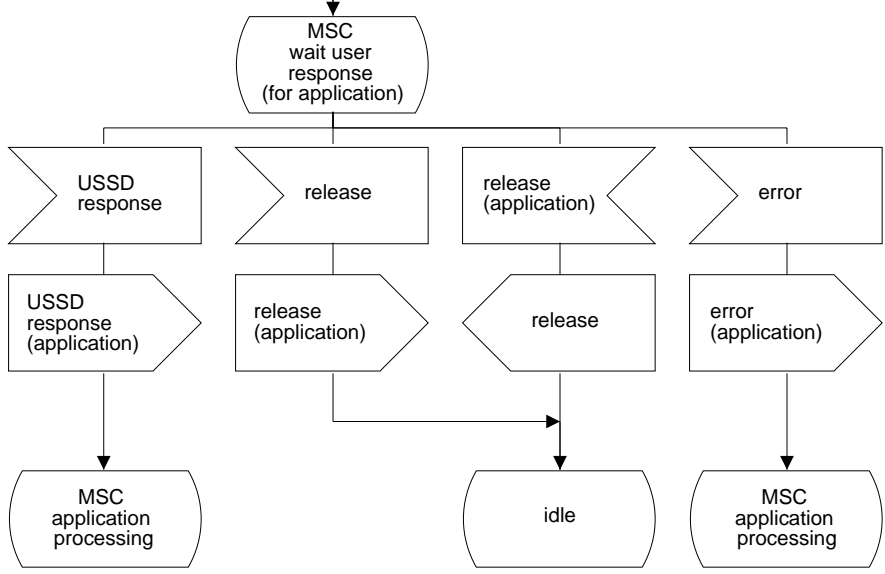
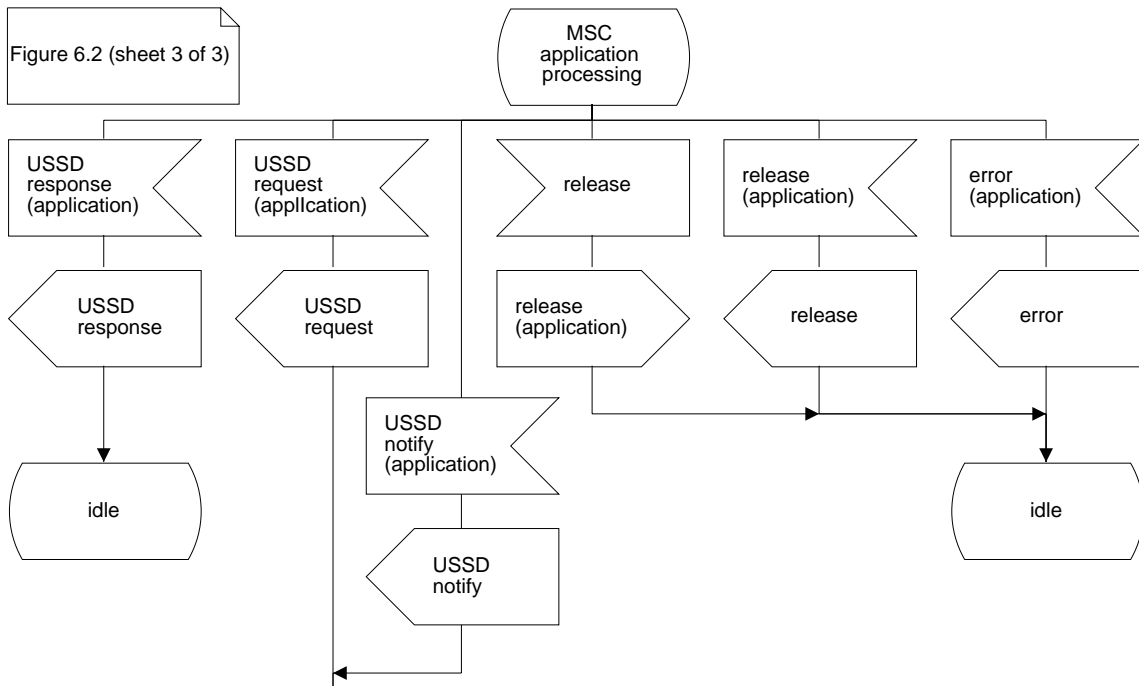

Figure 6.2 (sheet 2 of 3): Mobile initiated USSD at MSC

Process USSD_MI2

390_623(3)



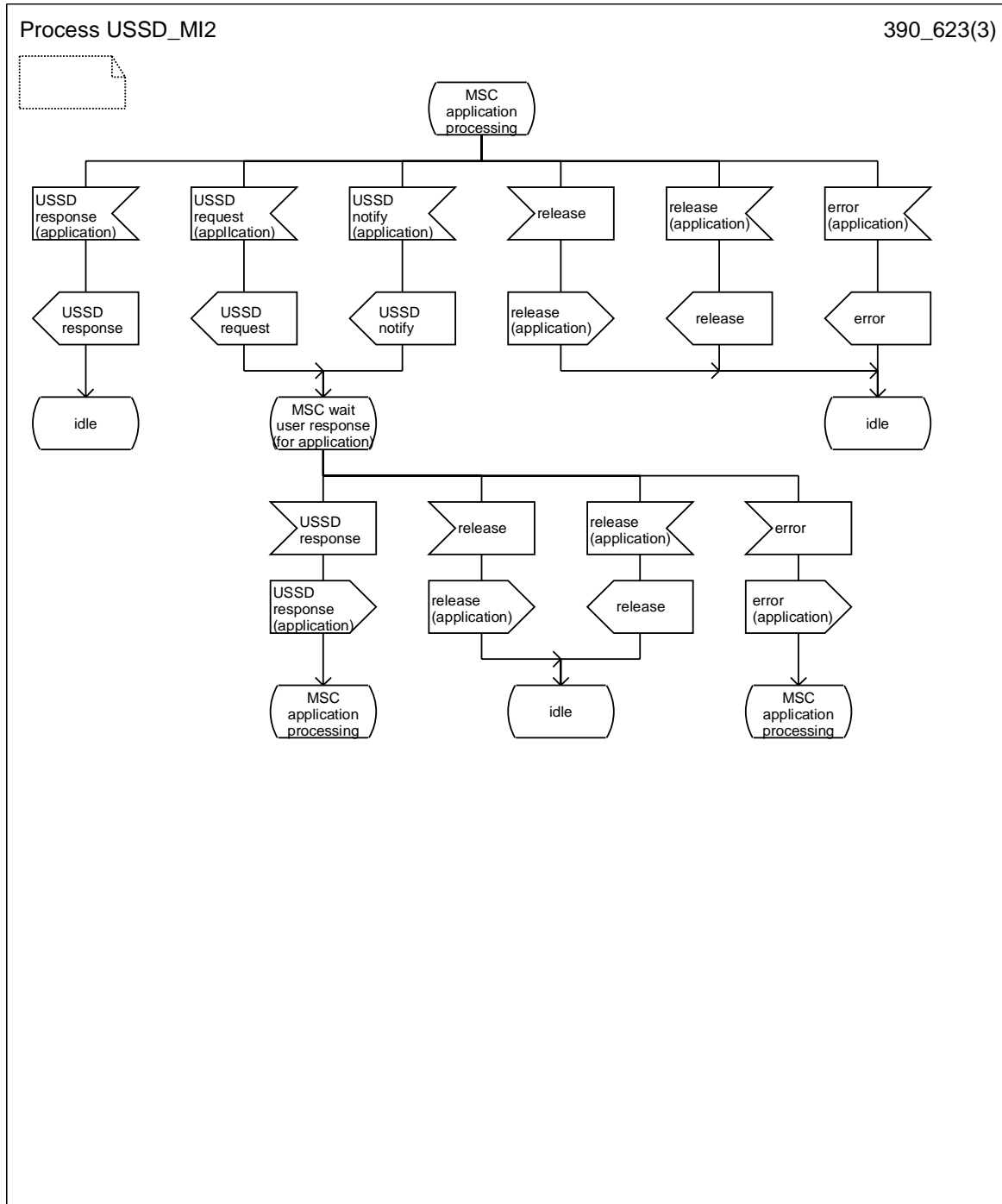

Figure 6.2 (sheet 3 of 3): Mobile initiated USSD at MSC

Process USSD_AI1

390_63(1)

Figure 6.3

INPUTS AND OUTPUTS
 For consistency with other SDL diagrams, all messages are shown to/from the right, for either the VLR or the application (as indicated).

USSD request from application is used when an application receives a request from a MS and passes on the request (changed or unchanged) or generates a new request.

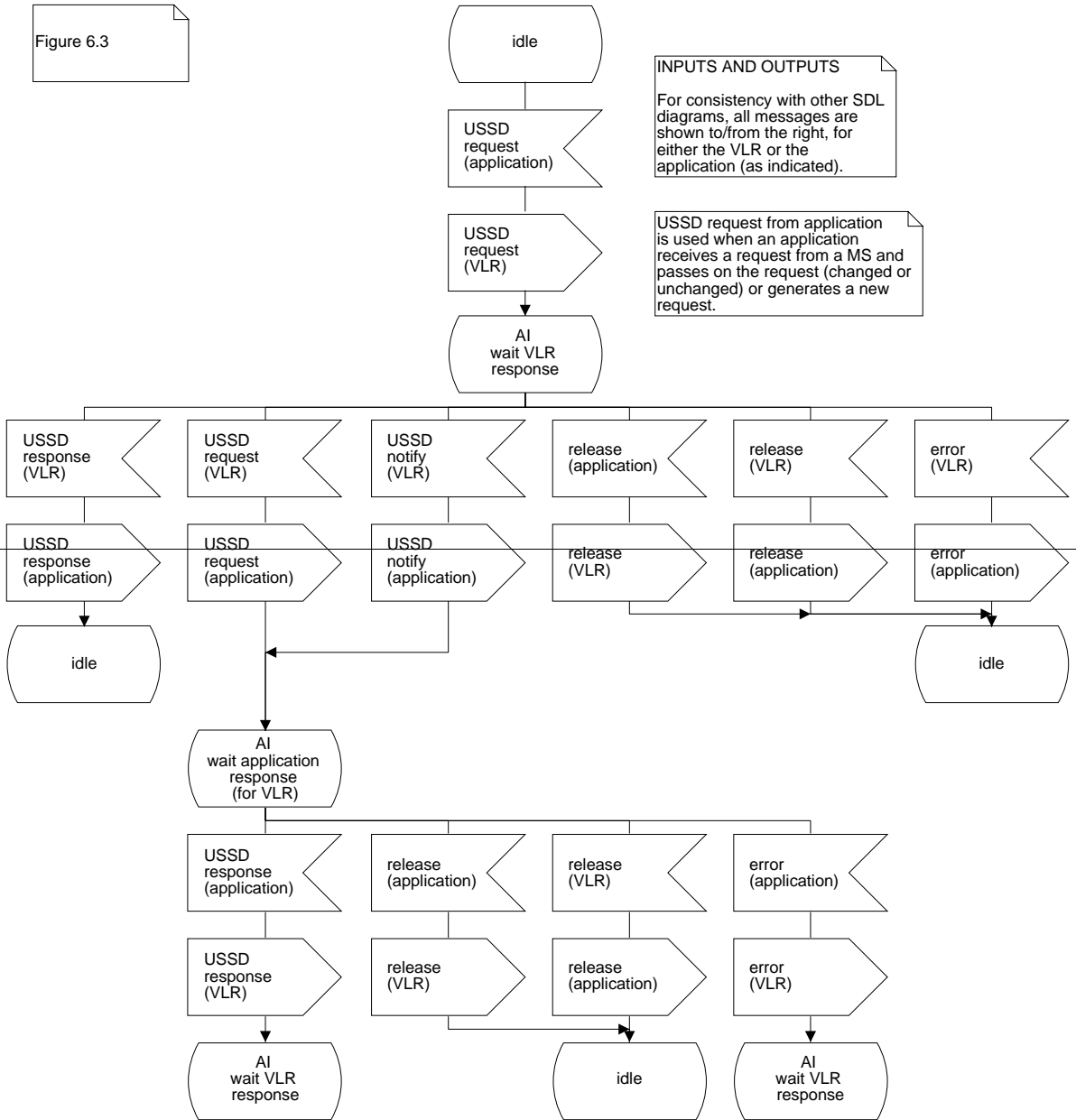

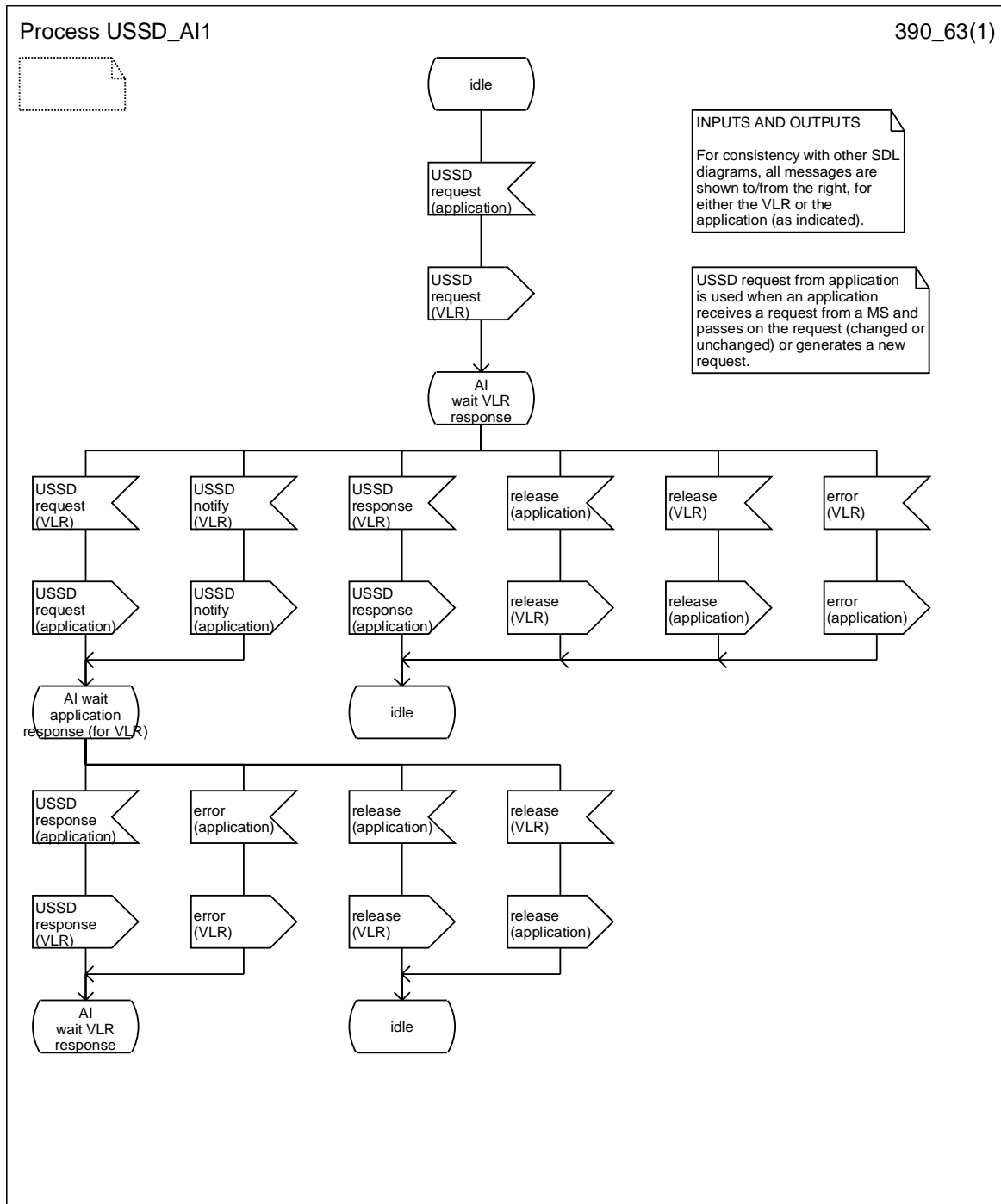

Figure 6.3: Application initiated USSD at MSC

Process USSD_MI3

390_641(3)

Figure 6.4 (sheet 1 of 3)

INPUTS AND OUTPUTS
Source/destination of messages shown to/from the left is the MSC.
Source/destination of messages shown to/from the right is either the HLR or the application (as indicated).

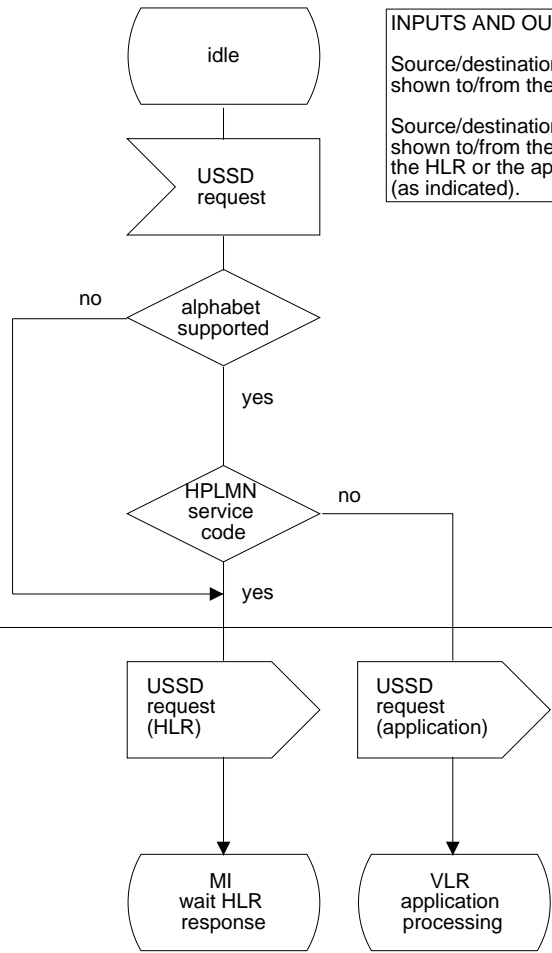

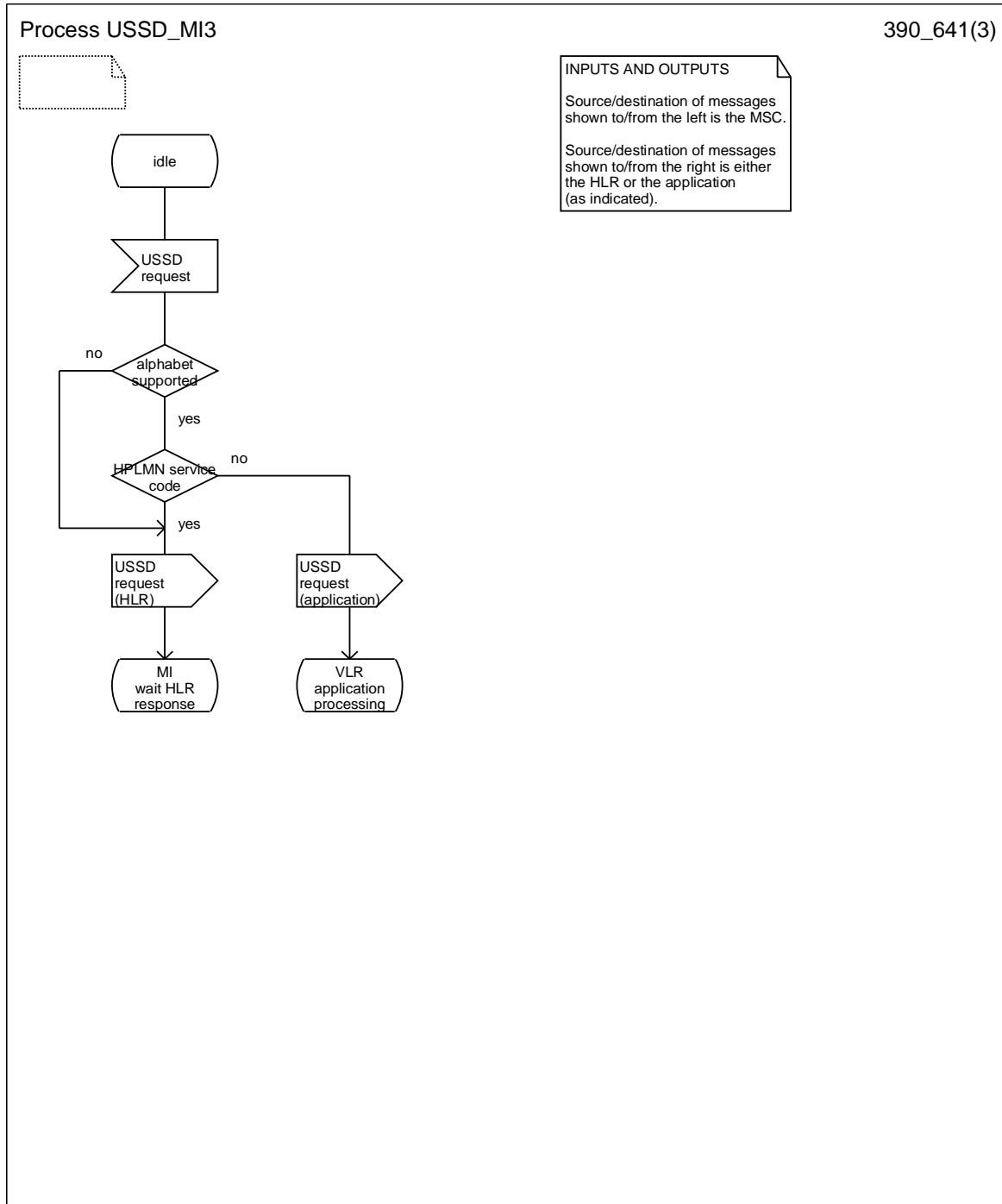
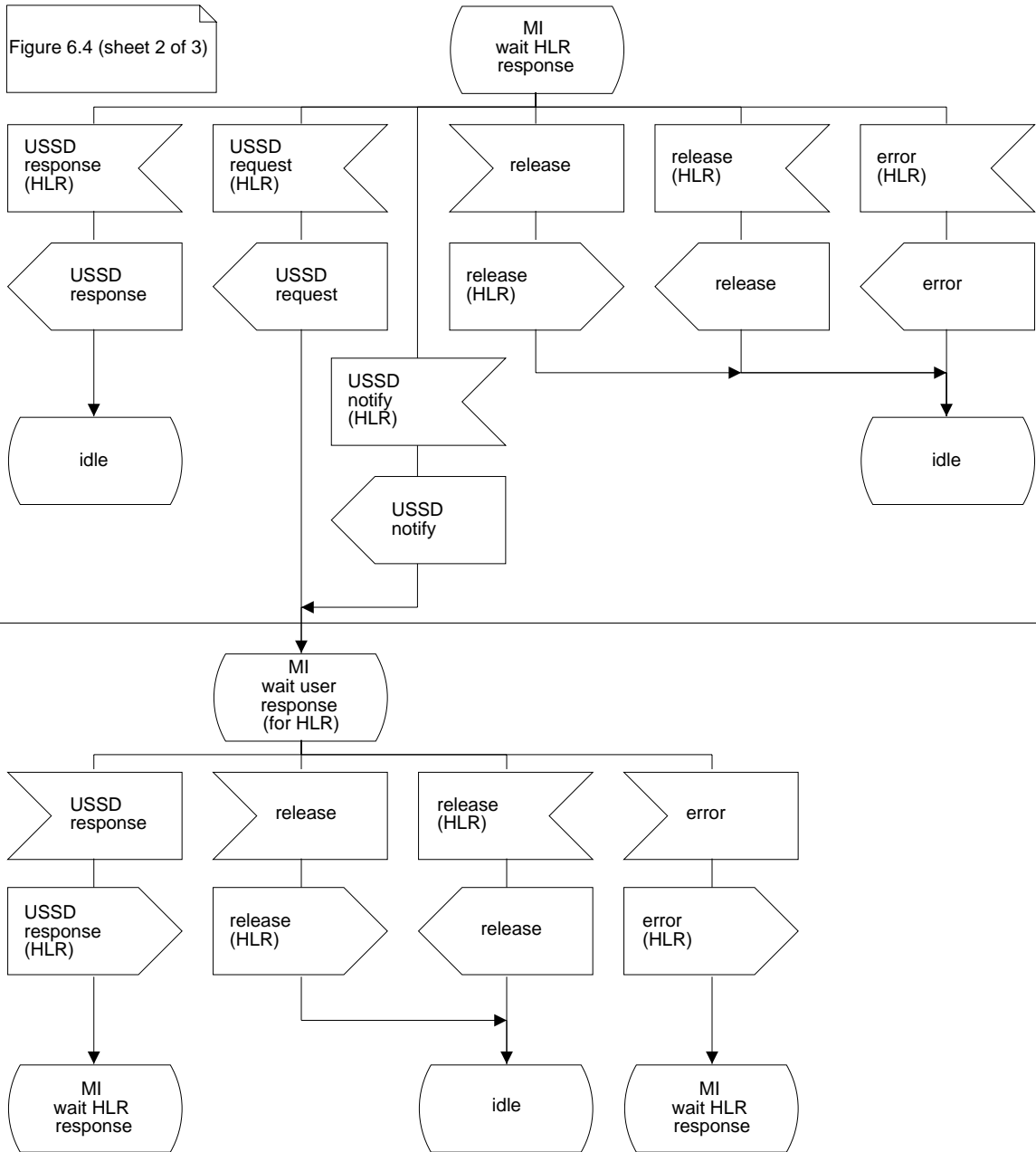

Figure 6.4 (sheet 1 of 3): Mobile initiated USSD at VLR

Process USSD_MI3

390_642(3)



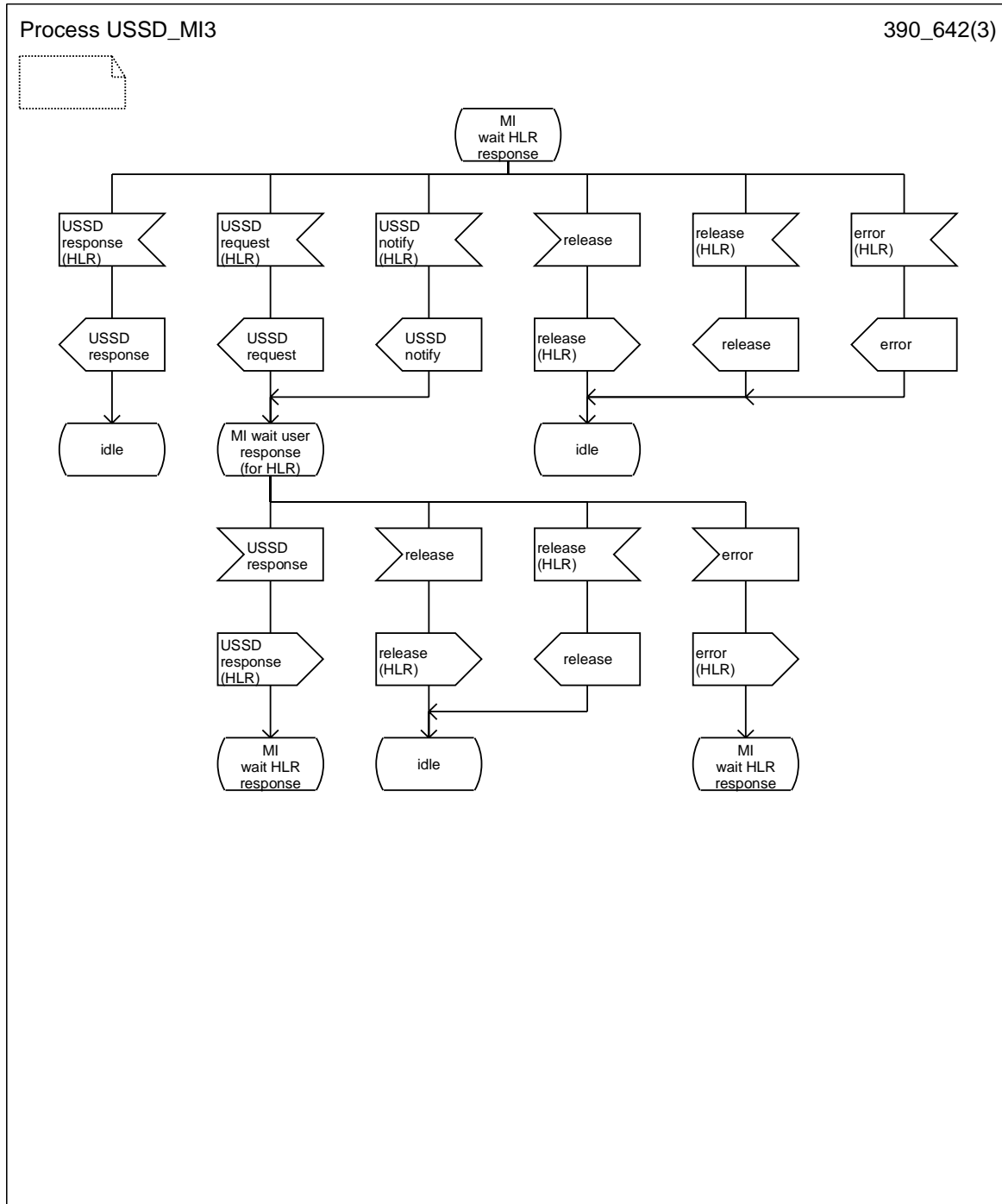
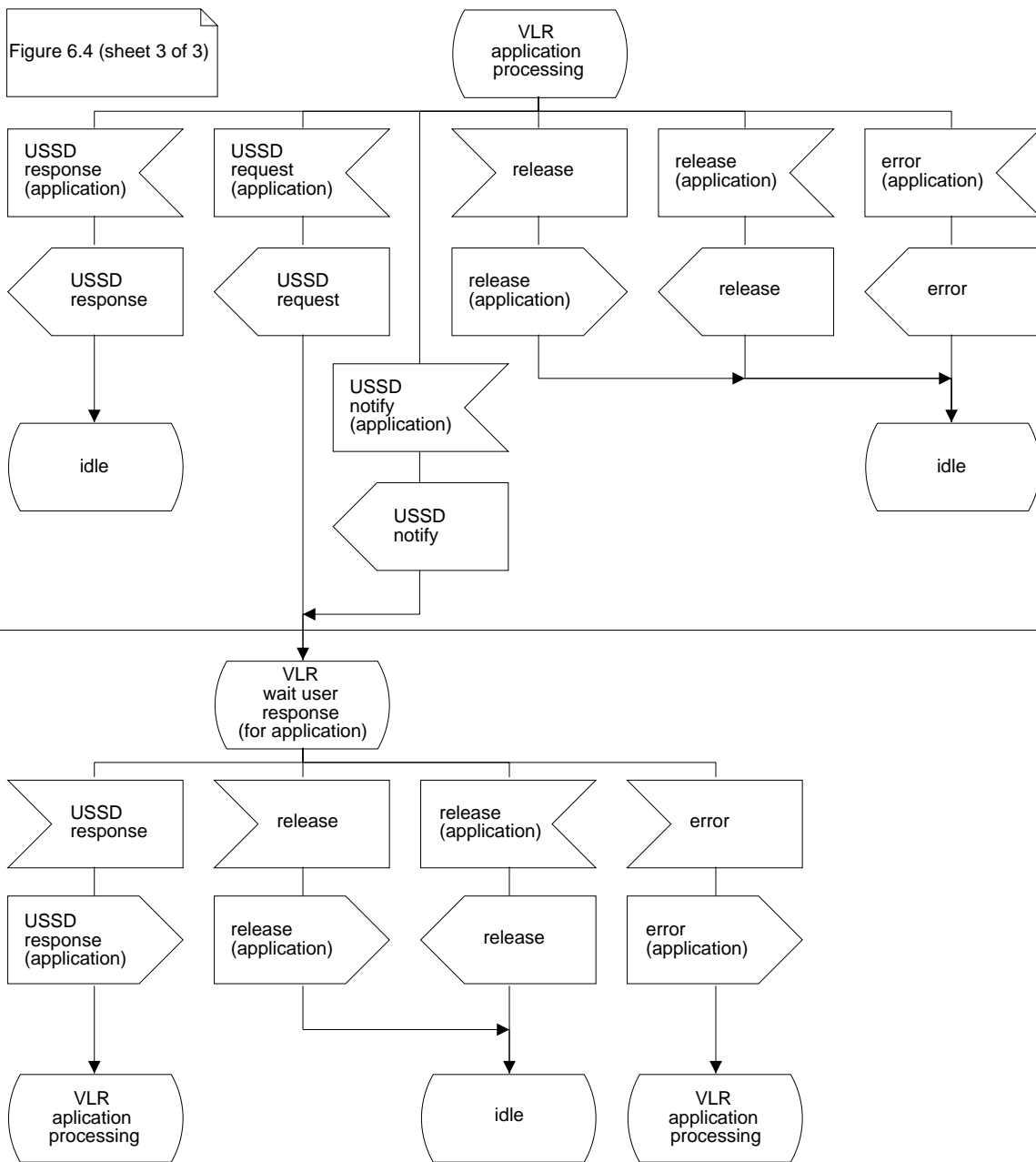

Figure 6.4 (sheet 2 of 3): Mobile initiated USSD at VLR

Process USSD_MI3

390_643(3)



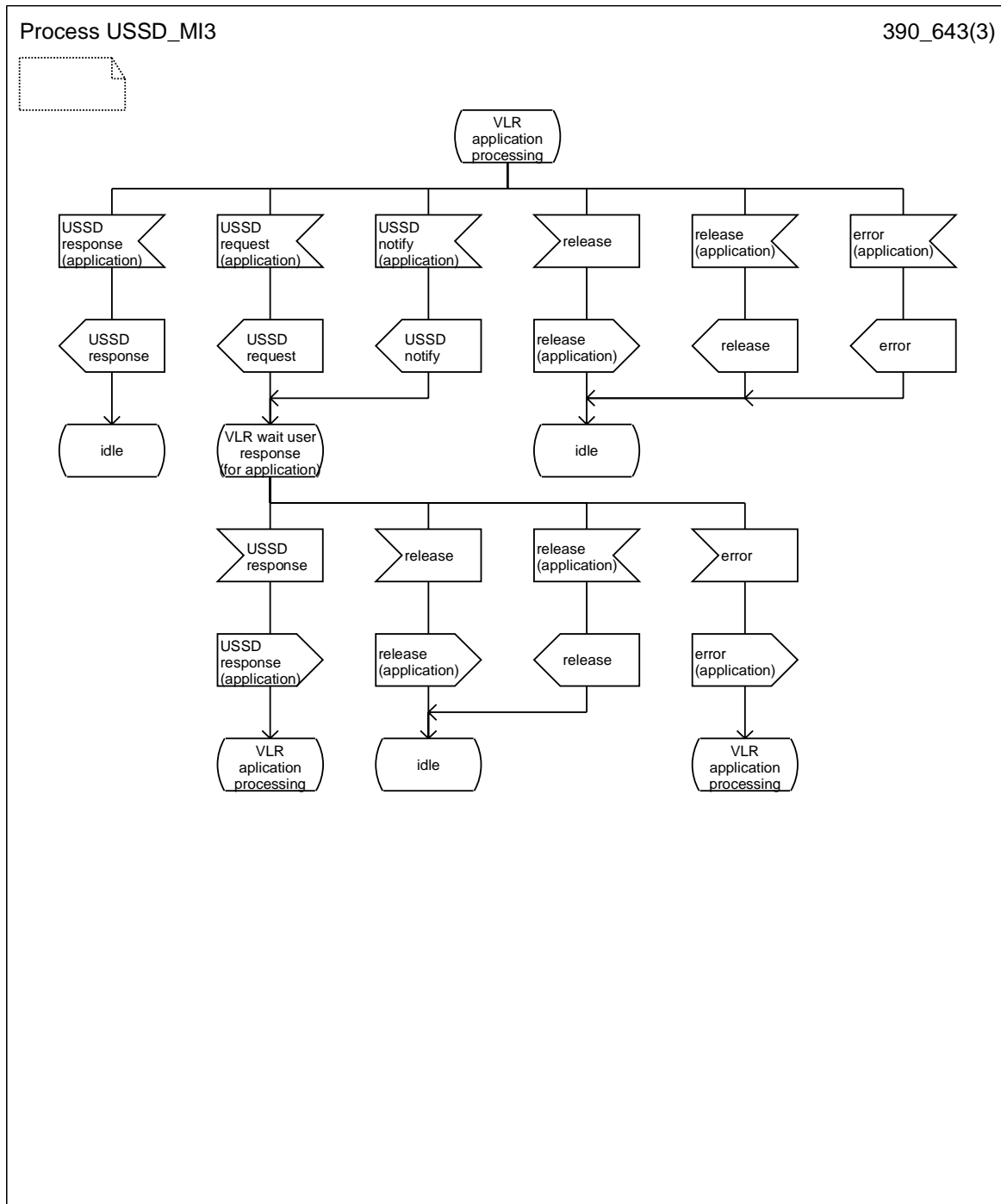

Figure 6.4 (sheet 3 of 3): Mobile initiated USSD at VLR

Process USSD_AI2

390_65(1)

Figure 6.5

INPUTS AND OUTPUTS
 For consistency with other SDL diagrams, all messages are shown to/from the right, for either the HLR or the application (as indicated).

USSD request from application is used when an application receives a request from a MS and passes on the request (changed or unchanged) or generates a new request.

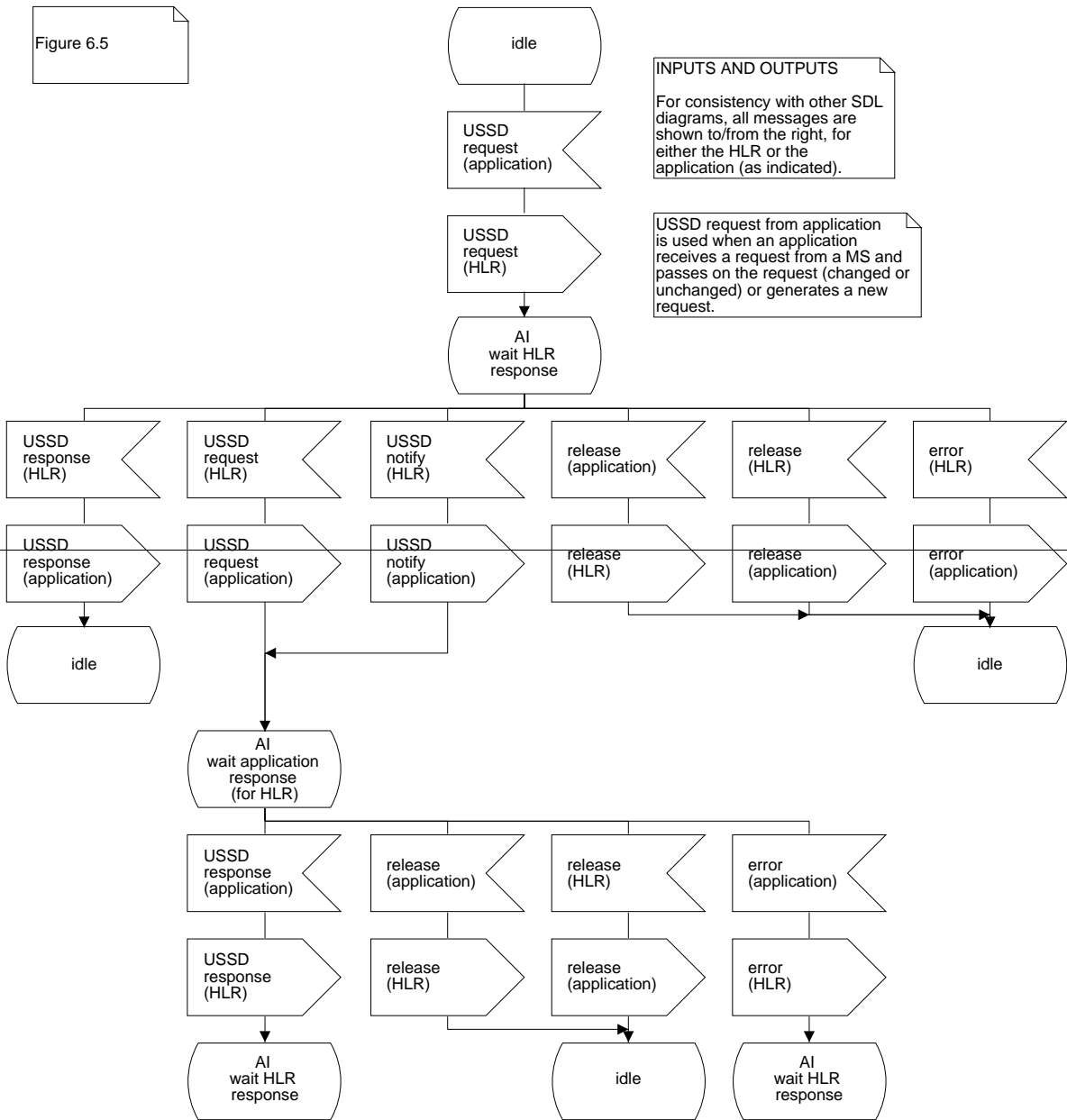

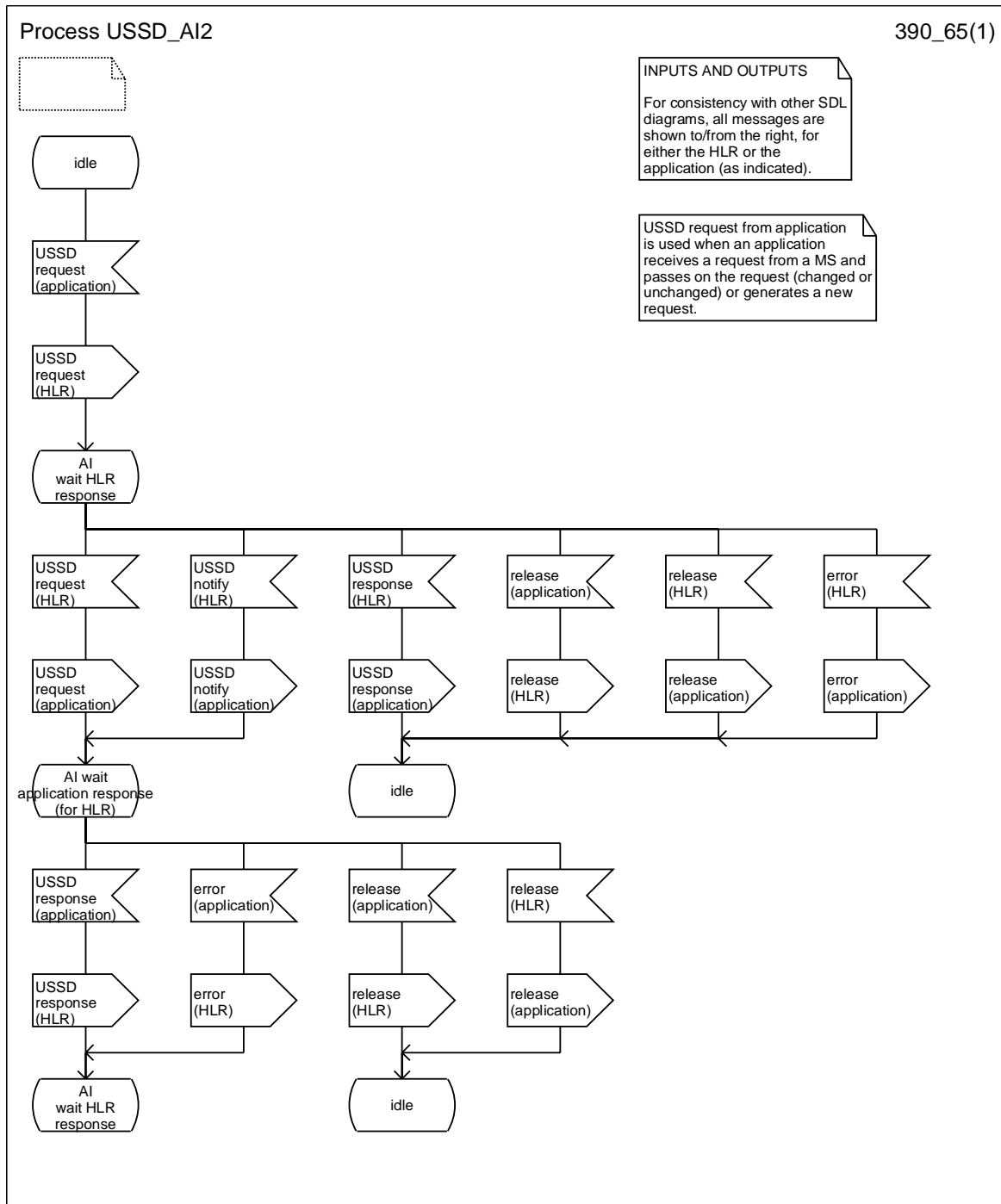
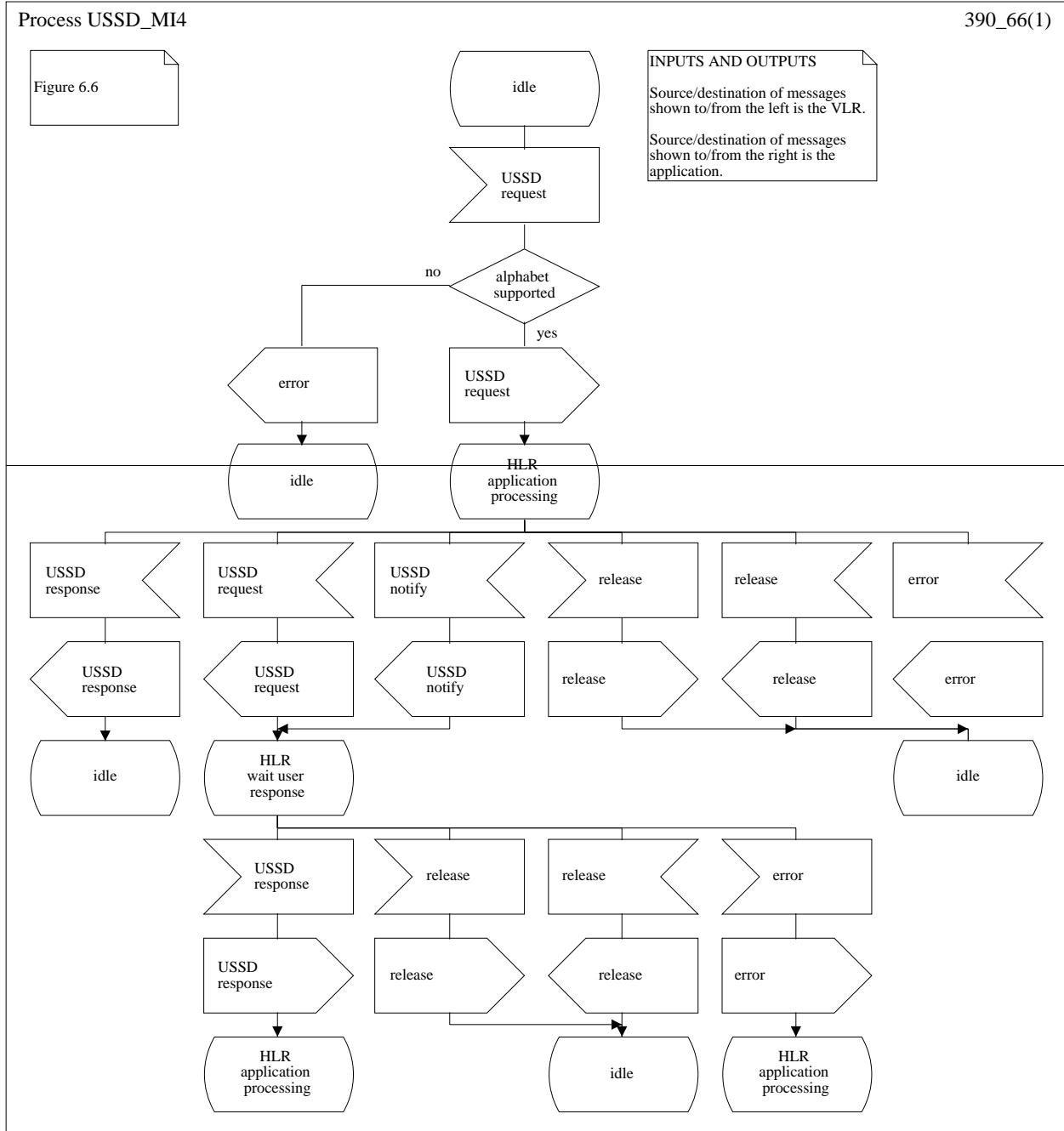

Figure 6.5: Application initiated USSD at VLR



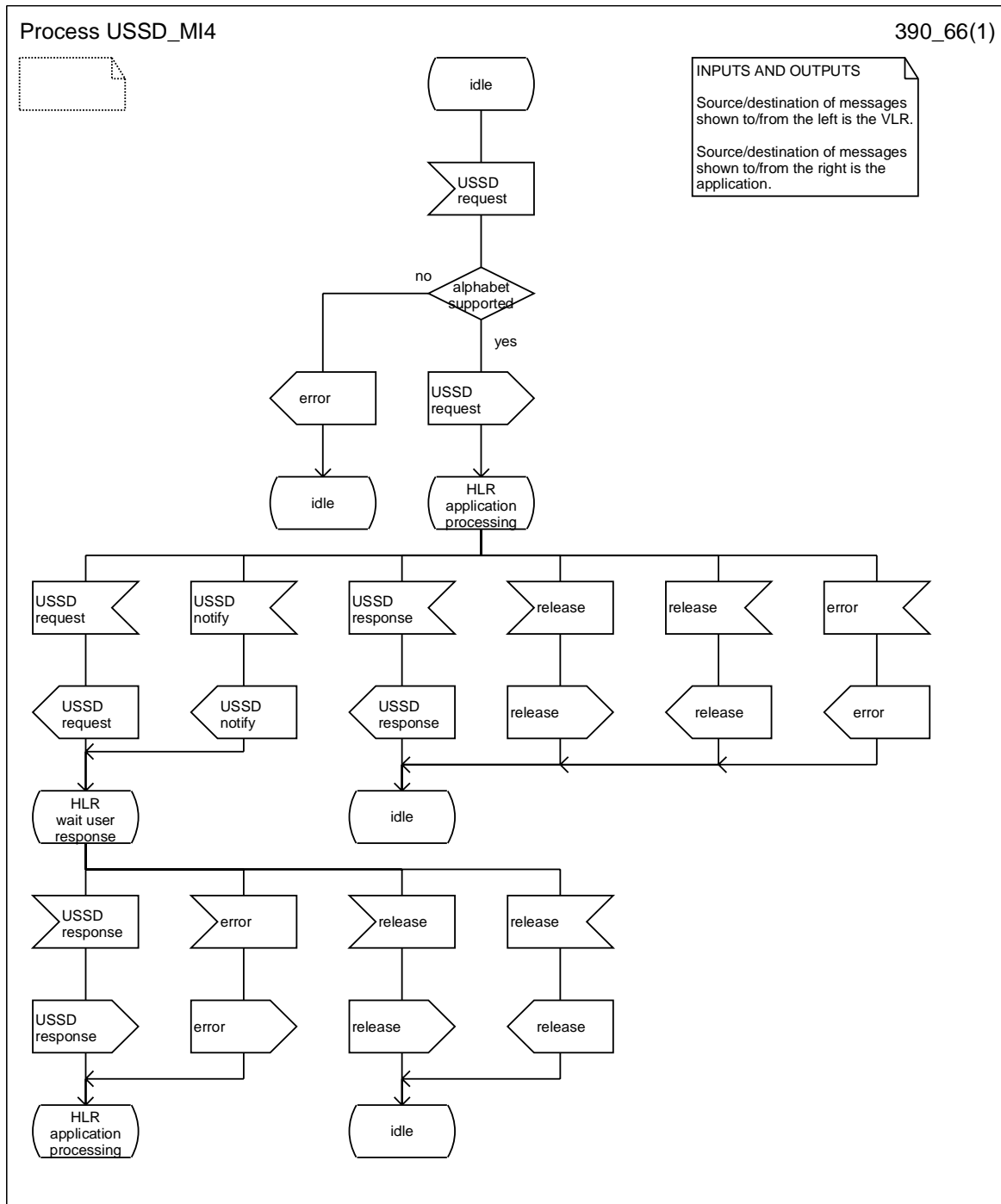

Figure 6.6: Mobile initiated USSD at HLR

CHANGE REQUEST		Please see embedded help file at the bottom of this page for instructions on how to fill in this form correctly.	
23.091 CR 002		Current Version: 3.1.0	
GSM (AA.BB) or 3G (AA.BBB) specification number ↑		↑ CR number as allocated by MCC support team	
For submission to: CN#09	for approval <input checked="" type="checkbox"/>	strategic <input type="checkbox"/>	(for SMG use only)
<i>list expected approval meeting # here ↑</i>	for information <input type="checkbox"/>	non-strategic <input checked="" type="checkbox"/>	

Form: CR cover sheet, version 2 for 3GPP and SMG The latest version of this form is available from: <ftp://ftp.3gpp.org/Information/CR-Form-v2.doc>

Proposed change affects: (U)SIM ME UTRAN / Radio Core Network
(at least one should be marked with an X)

Source: N4 **Date:** 2000-06-26

Subject: SDL refresh

Work item: TEI

Category:	F Correction <input type="checkbox"/> A Corresponds to a correction in an earlier release <input type="checkbox"/> B Addition of feature <input type="checkbox"/> C Functional modification of feature <input type="checkbox"/> D Editorial modification <input checked="" type="checkbox"/>	Release:	Phase 2 <input type="checkbox"/> Release 96 <input type="checkbox"/> Release 97 <input type="checkbox"/> Release 98 <input type="checkbox"/> Release 99 <input checked="" type="checkbox"/> Release 00 <input type="checkbox"/>
(only one category Shall be marked With an X)			

Reason for change: The SDL diagrams in this document have been replaced, without any semantic changes due to the following reasons:

- In the previous version, the diagrams contained nothing but garbage when viewed on-screen.
- Some of the diagrams were, if not impossible, very hard to print.
- A binary version of the SDL diagrams, suitable for standard tools, is needed to assure a qualitative handling of the diagrams in the future. Telelogic Tau SDL Suite (formerly known as SDT) versions of the diagrams have been created and made available, providing a new fresh base for future changes. For obvious reasons, the binary version, to be regarded as the source, should be mirrored in the document. Therefore, the diagrams replacing the previous versions are printouts of the binary versions.

Clauses affected: All figures in the document, containing an SDL diagram.

Other specs Affected:	Other 3G core specifications <input type="checkbox"/> Other GSM core specifications <input type="checkbox"/> MS test specifications <input type="checkbox"/> BSS test specifications <input type="checkbox"/> O&M specifications <input type="checkbox"/>	→ List of CRs: → List of CRs: → List of CRs: → List of CRs: → List of CRs:	
------------------------------	---	--	--

Other comments: ETSI plans to make the binary versions of the SDL diagrams available on the 3GPP web-site.

4.1 Functions

The following function has been identified for the explicit call transfer service:

MAF027

Explicit Call Transfer related authorizations examination

The ability of a PLMN component to determine the authorizations relating to explicit call transfer. See figure 1.

Location: VLR

Within the authorization examinations diagram, the messages shown to and from the left are to and from the MSC.

After receiving a "invoke ECT request" the VLR will check if the Explicit Call Transfer service is provisioned for the served subscriber. If the service is provisioned the VLR send back to the MSC "Explicit Call Transfer available". If the service is not provisioned the VLR will send back to the MSC "Explicit Call Transfer not available". When the response has been sent back to the MSC the process will return to the idle state.

Process MAF027

391_1(1)

Figure 1: Explicit Call transfer related authorisations examination (VLR)

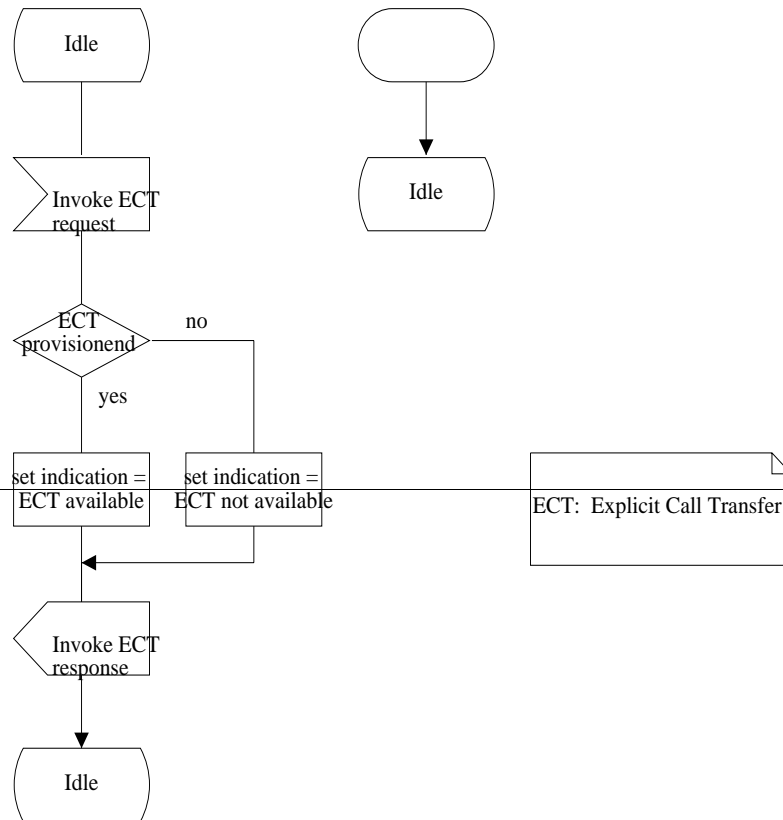

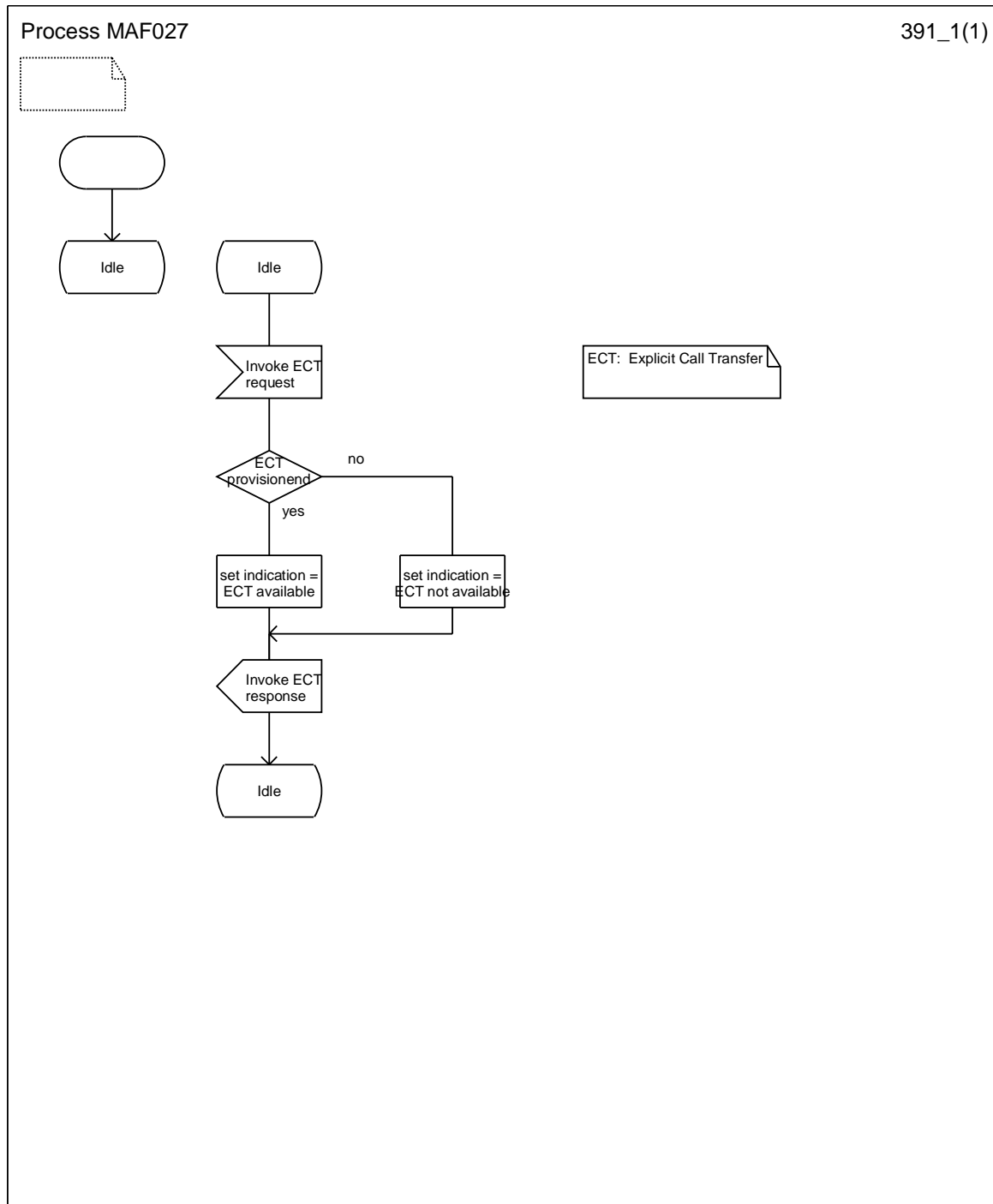

Figure 1: Explicit Call Transfer related authorizations examination (VLR)

4.2 Overall SDL-diagrams and information flows

4.2.1 General description

The overall SDL-diagrams represent the network as a whole. The overall SDL-diagrams show the status of the service as perceived by the served mobile subscriber, as well as the status as perceived by any of the other parties. Besides this, the overall SDL-diagrams show the actions to be taken by the network and the information provided by the network to the users.

Within the overall SDL-diagrams, messages to and from the served mobile subscriber are indicated to and from the left, whereas messages to and from remote parties are indicated to and from the right.

The following states for the invocation of the ECT supplementary service are defined:

- a) First Call (Active, Held), Second Call (Active, Idle);
- b) Second Call (Active, Held), First Call (Active, Idle);
- c) First Call (Active, Held), Second Call (Call Delivered, Idle).

These two dimensional states are also used in the SDLs and information flows:

- the first dimension is a normal basic call state "active" or "call delivered";
- the second dimension is "held" meaning that the call is set on hold.

NOTE: The call state "call delivered" means that a ALERT message has been received in the MS, but no ANSWER MESSAGE (ANM) is received.

In the information, flows it is assumed that the served subscriber is a mobile subscriber and that the other parties are mobile or fixed subscribers.

Party A is the subscriber controlling the Explicit Call Transfer Call (served mobile subscriber). Party B is the first remote party called. Party C is the second remote party called.

The served party is disconnected by the generic disconnect/release procedure after a successful transfer request. The connection of the remote party calls in a new call (transferred call) is located in the MSC.

The first figures of the information flows (figures 4 and 7) show the unsuccessful case of the transfer request (check in the VLR or in the MSC fails).

The second figures (figures 5 and 8) show the successful case of the transfer request.

4.2.2 ECT (both calls answered)

After receipt of a ECT request from the served subscriber, the MSC/VLR will check if the Explicit Call Transfer supplementary service is provisioned for the served subscriber (see also MAF027).

If the ECT Supplementary Service is provisioned, then the MSC/VLR will check if the transfer is barred by virtue of call states or supplementary service interactions (see also figure 3 and subclause 4.3).

If there are no such barring causes then the MSC/VLR also checks if CUG restrictions are infringed (see also figure 3 and subclause 4.3).

If the outcome of these checks are successful and the loop prevention option is supported, an endless loop prevention check shall be performed according to T/S 22-21 (version 9) and DE/SPS6001.22 (version 9).

If the result of this check is also successful the both calls shall be connected in the MSC (without including the served subscriber in this connection), the held party will be retrieved and both remote parties will be notified that call transfer was done.

With this notification the both subscribers will be informed about the state of the other remote party in which call transfer was done ("call transferred, active") and if possible about the identity (Redirection number) of each other (for details see also subclause 4.3).

After that the served mobile subscriber will be disconnected from both calls.

If the checks fail the ECT request will be rejected and the two calls remain in the call states in which they were before ECT was attempted.

The overall SDL for Explicit Call Transfer (both calls are answered) is shown in figure 2.

The checks if Explicit Call Transfer is barred or not are shown in figure 3.

The corresponding information flows are given in figure 4 and figure 5.

Process ect_overall_1

391_2(1)

Overall SDL-diagramm of explicit call transfer (both calls answered)

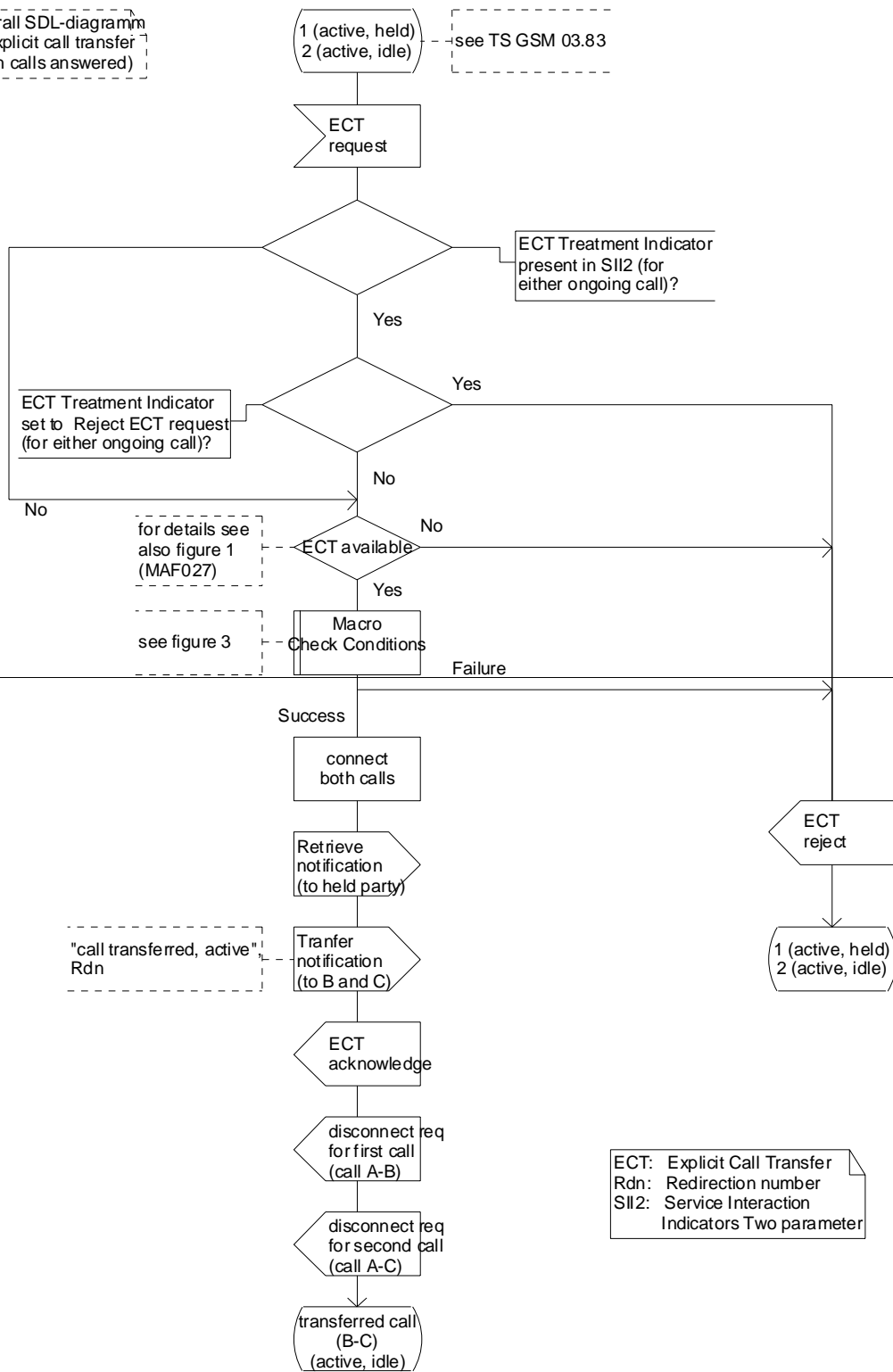

ECT: Explicit Call Transfer
Rdn: Redirection number
SI12: Service Interaction Indicators Two parameter

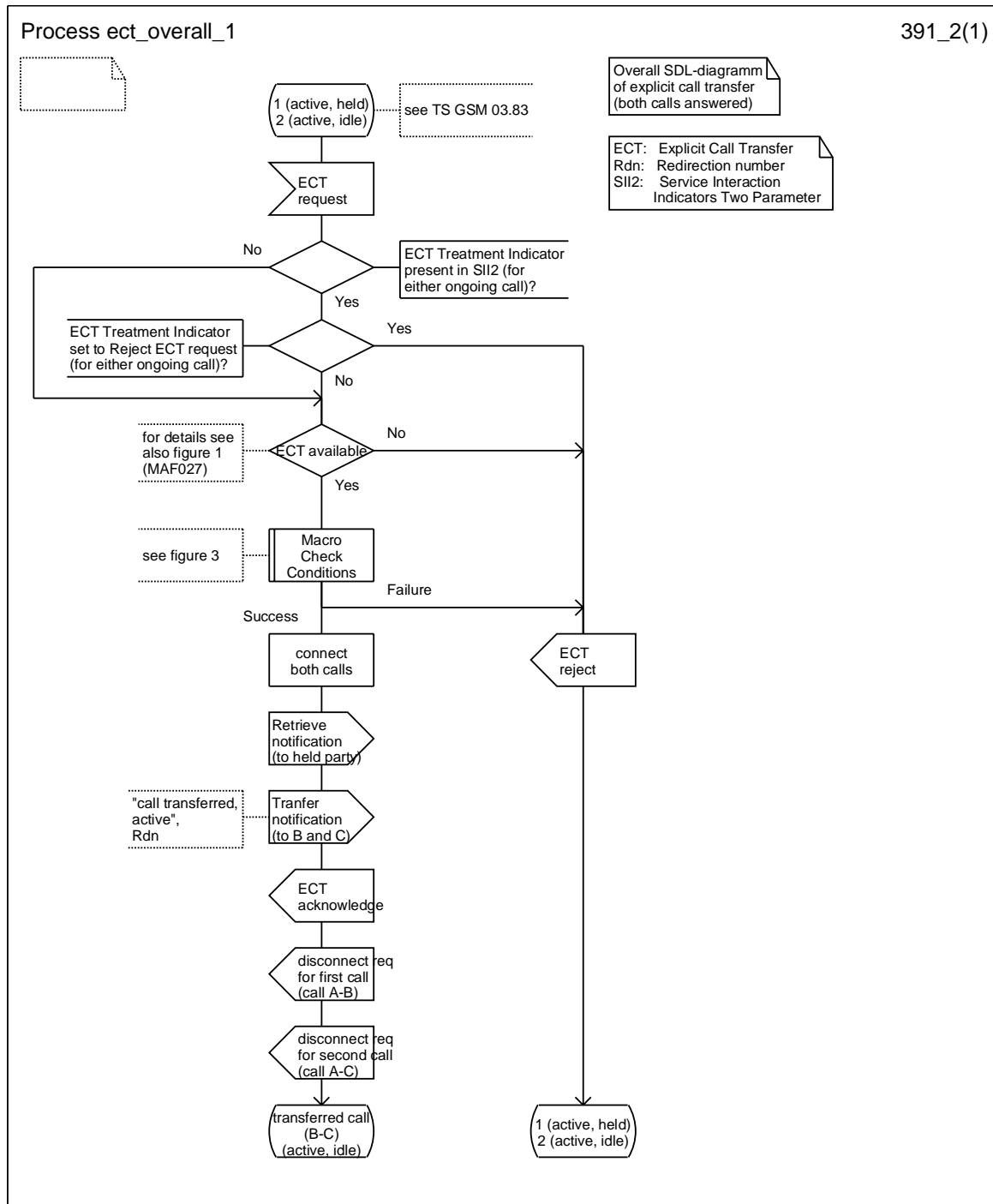
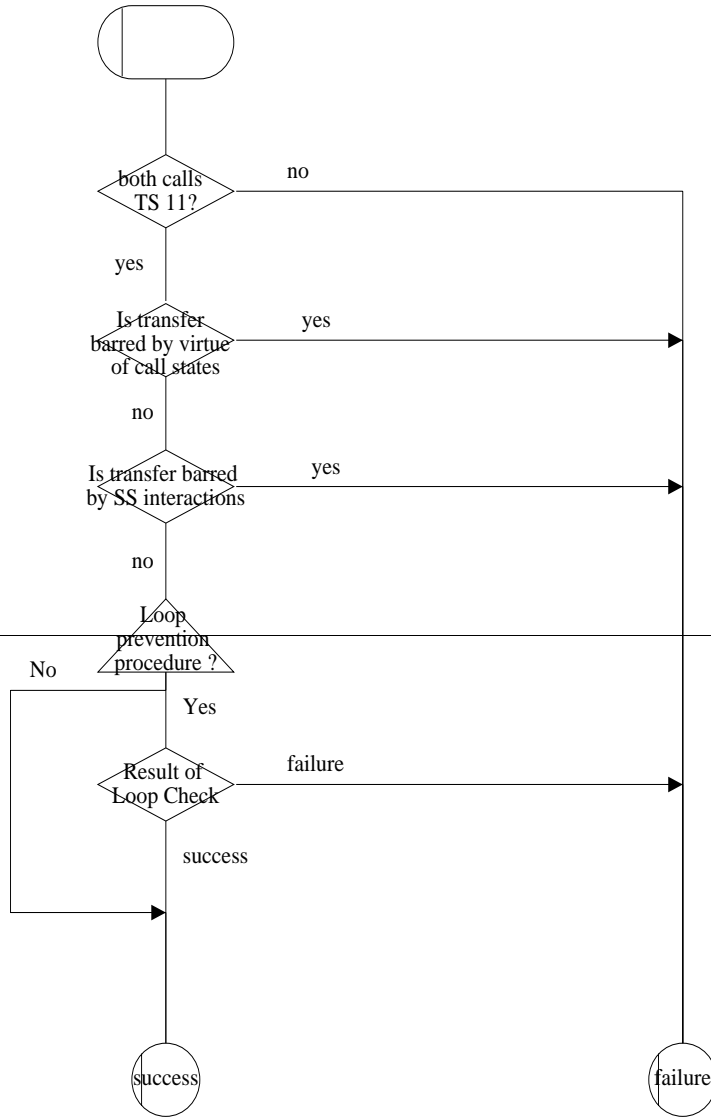

Figure 2: Overall SDL-diagram of Explicit Call Transfer (both calls answered)

Macro Check_Conditions

391_3(1)

Macro Check Conditions checks all conditions for Explicit Call Transfer are fulfilled



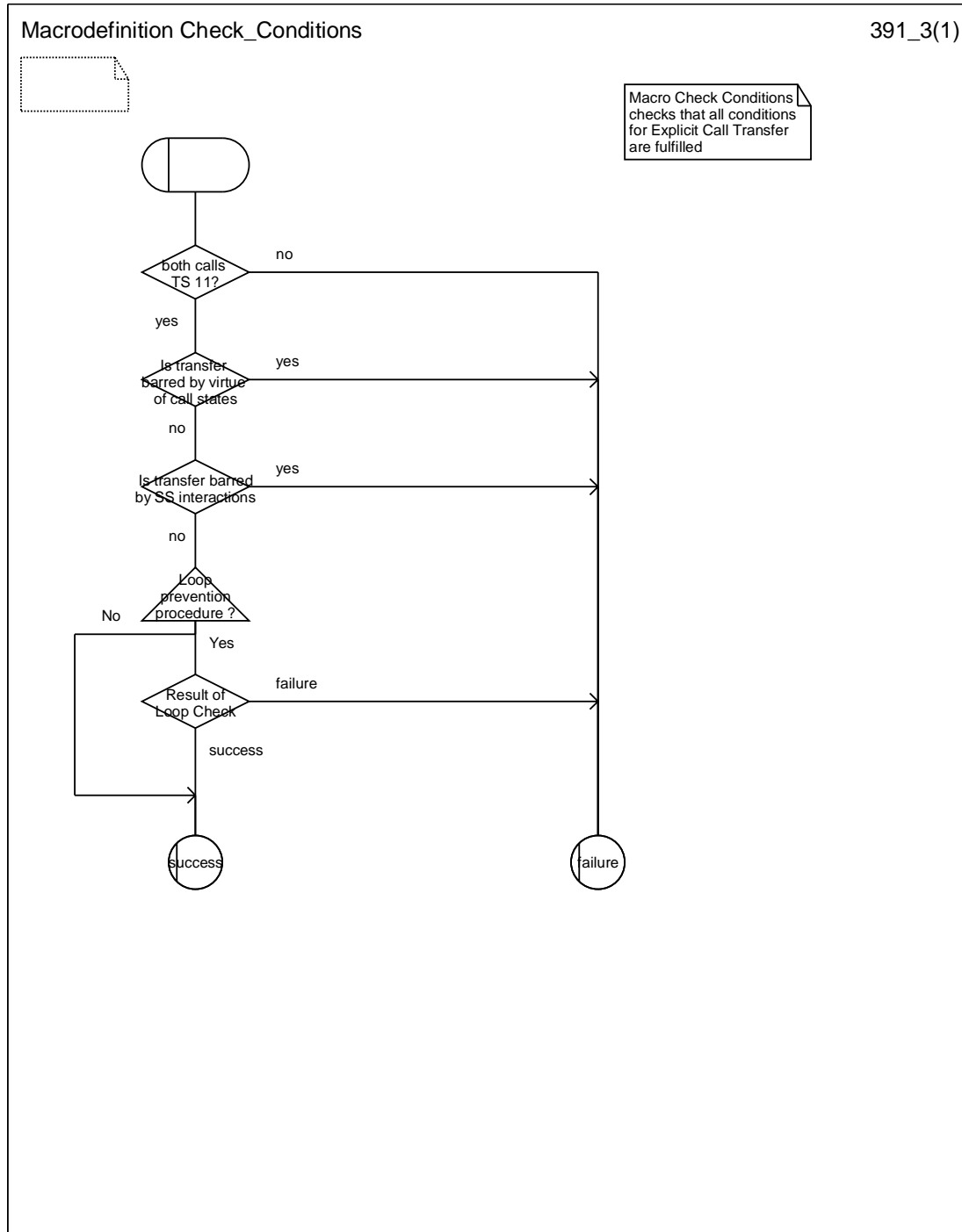
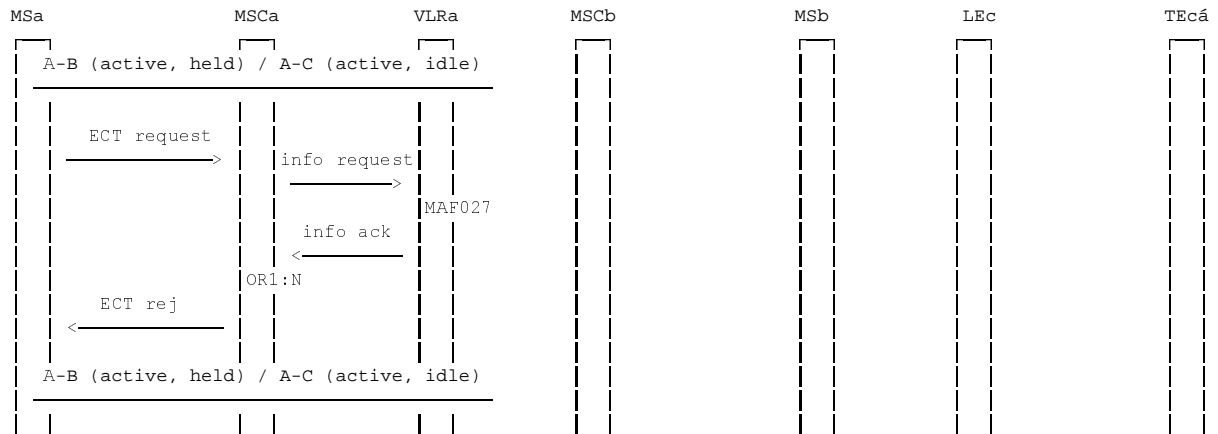
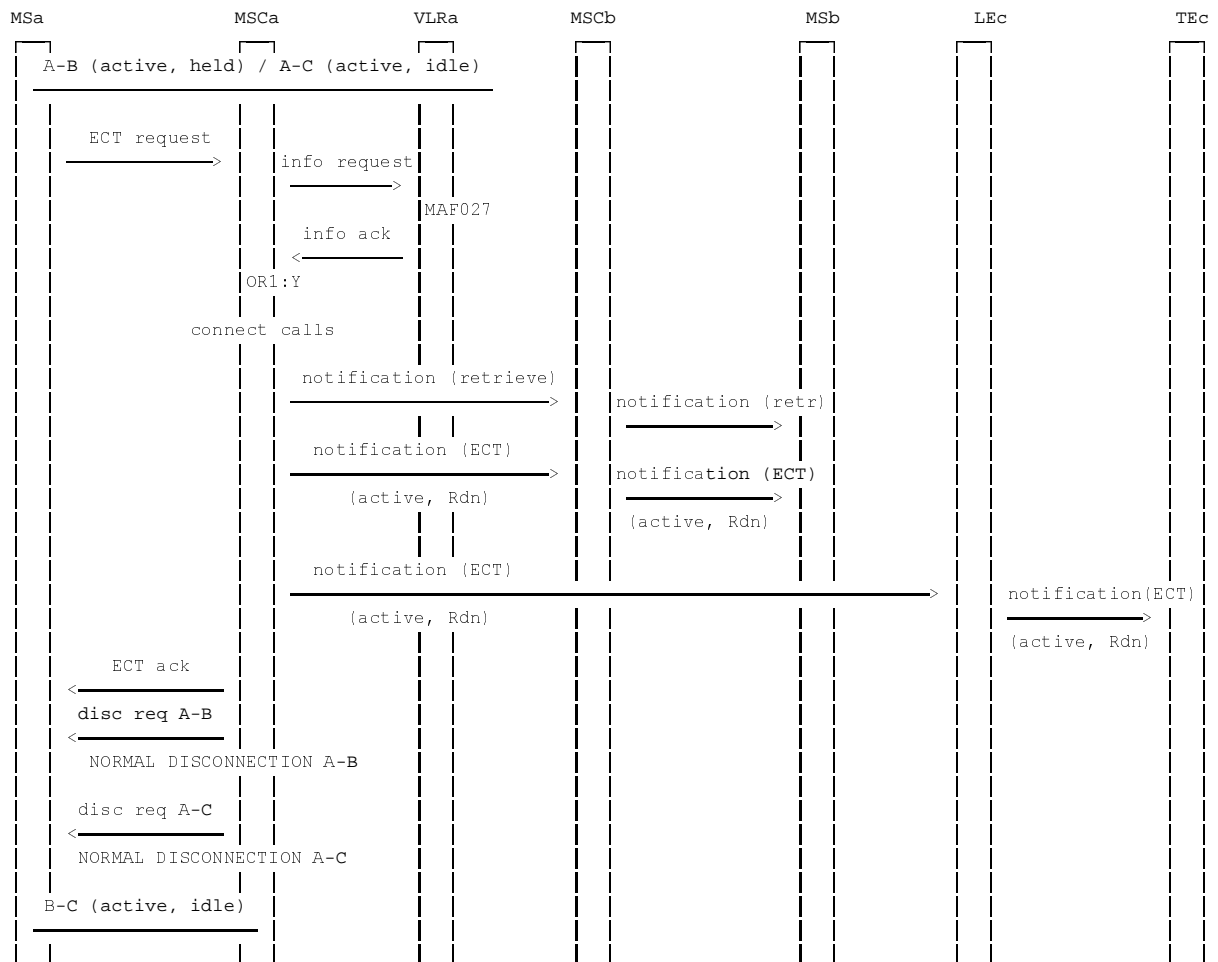

Figure 3: Macro Check Conditions



NOTE: OR1: Checks in VLR and MSC ok? (Y: yes N: no).

Figure 4: Information flow for failed explicit call transfer (both calls answered)



NOTE: OR1: Checks in VLR and MSC ok? (Y: yes N: no).

Figure 5: Information flow for successful explicit call transfer (both calls answered)

4.2.3 ECT (one call answered, the other alerting)

In this case, generally the same procedures will apply as in the other case (both calls answered). The same checks shall be performed and if all checks are fulfilled both calls shall be connected together (without including the served subscriber in this connection). After the connection of the both calls, both subscriber (B and C) will be notified about the call transfer invocation in the same way as in the case where the two calls are answered.

The transfer notification to the subscriber B will include the information that the transfer was done in the alerting state of subscriber C ("call transferred, alerting"). After receipt of the answer message from subscriber C, the subscriber B will be notified again, indicating that answer has taken place subsequent to the alerting transfer ("call transferred, active").

The overall SDL for Explicit Call Transfer (one call answered, the other alerting) is shown in figure 6.

The corresponding information flows are given in figure 7 and figure 8.

Process ect_overall_2

391_61(2)

Overall SDL-diagramm of explicit call transfer (one call answered, the other altering)

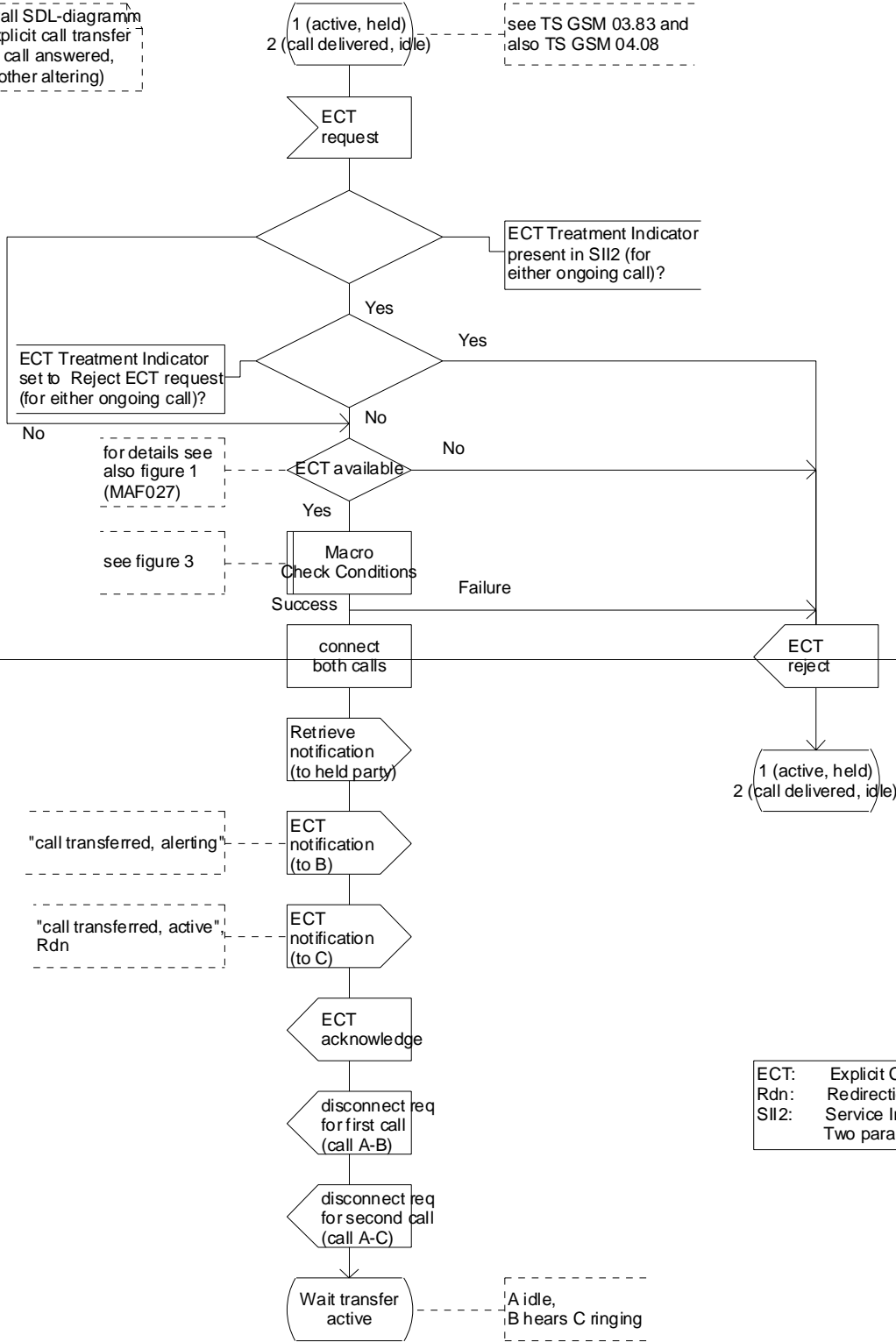

ECT: Explicit Call Transfer
Rdn: Redirection number
SI12: Service Interaction Indicators Two parameter

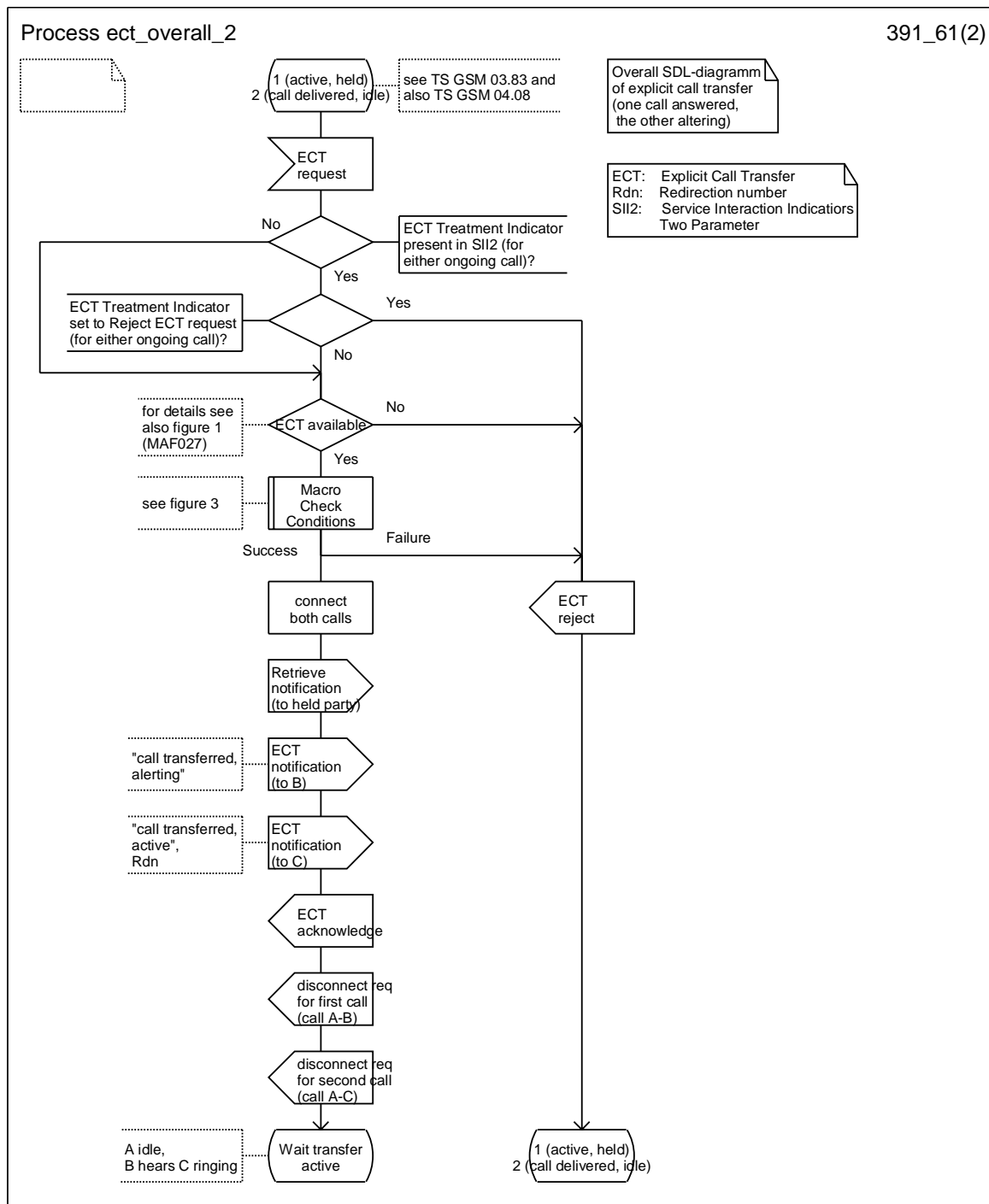
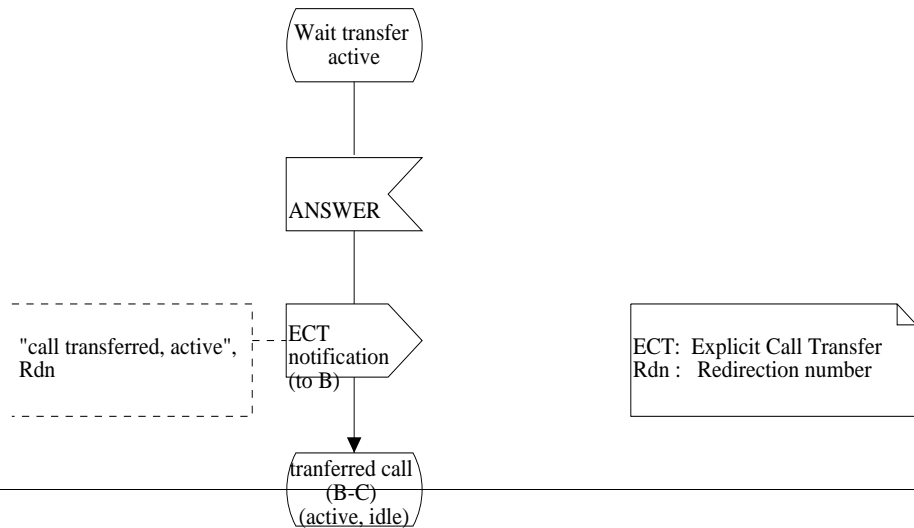

Figure 6: Overall SDL-diagram of explicit call transfer (one call answered, the other alerting) (page 1 of 2)

Process ect_overall_2

391_62(2)

Overall SDL-diagramm
of explicit call transfer
(one call answered,
the other altering)



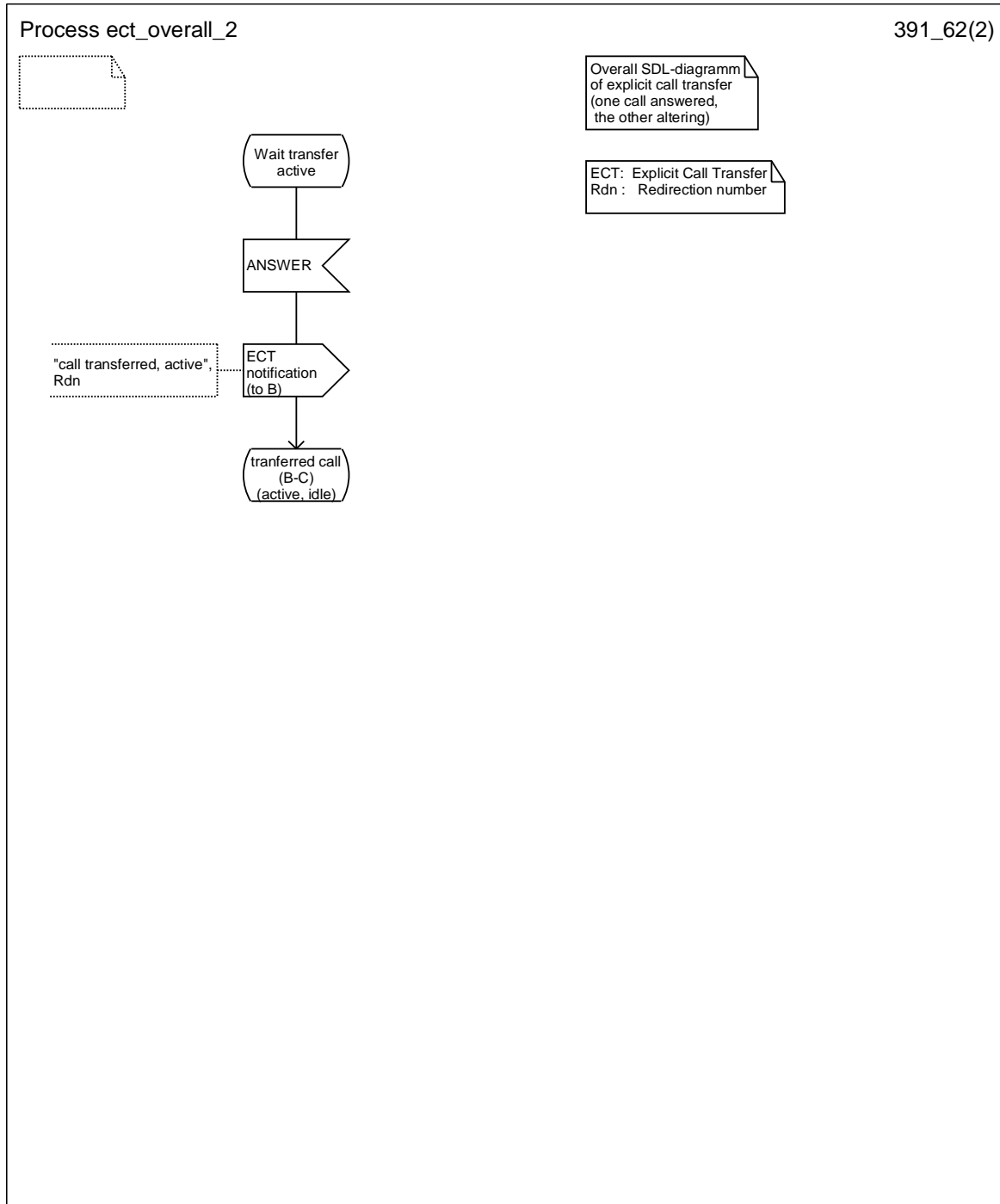

Figure 6: Overall SDL-diagram of explicit call transfer (one call answered, the other alerting) (page 2 of 2)

19.2.2.5 SDL Diagrams

The SDL diagrams on the following pages describe the user processes in MSC-A for the procedures described in this subclause.

The services used are defined in subclause 8.4.

NOTE: The message primitives HO_CA_MESSAGE used in the SDL-Diagrams are used to show the internal co-ordination between the MAP application and the Handover Control Application. For a detailed description of the co-ordination between the applications for the handover or relocation procedure, see 3G TS 23.009.

Note that in case of reception of errors from the MSCs (see the Handover error handling macro), the MAP user reports them to the Handover Control Application and does not take any action except in cases explicitly mentioned in the SDL diagrams.

Figure 19.2 2/1: HO in MSC-A

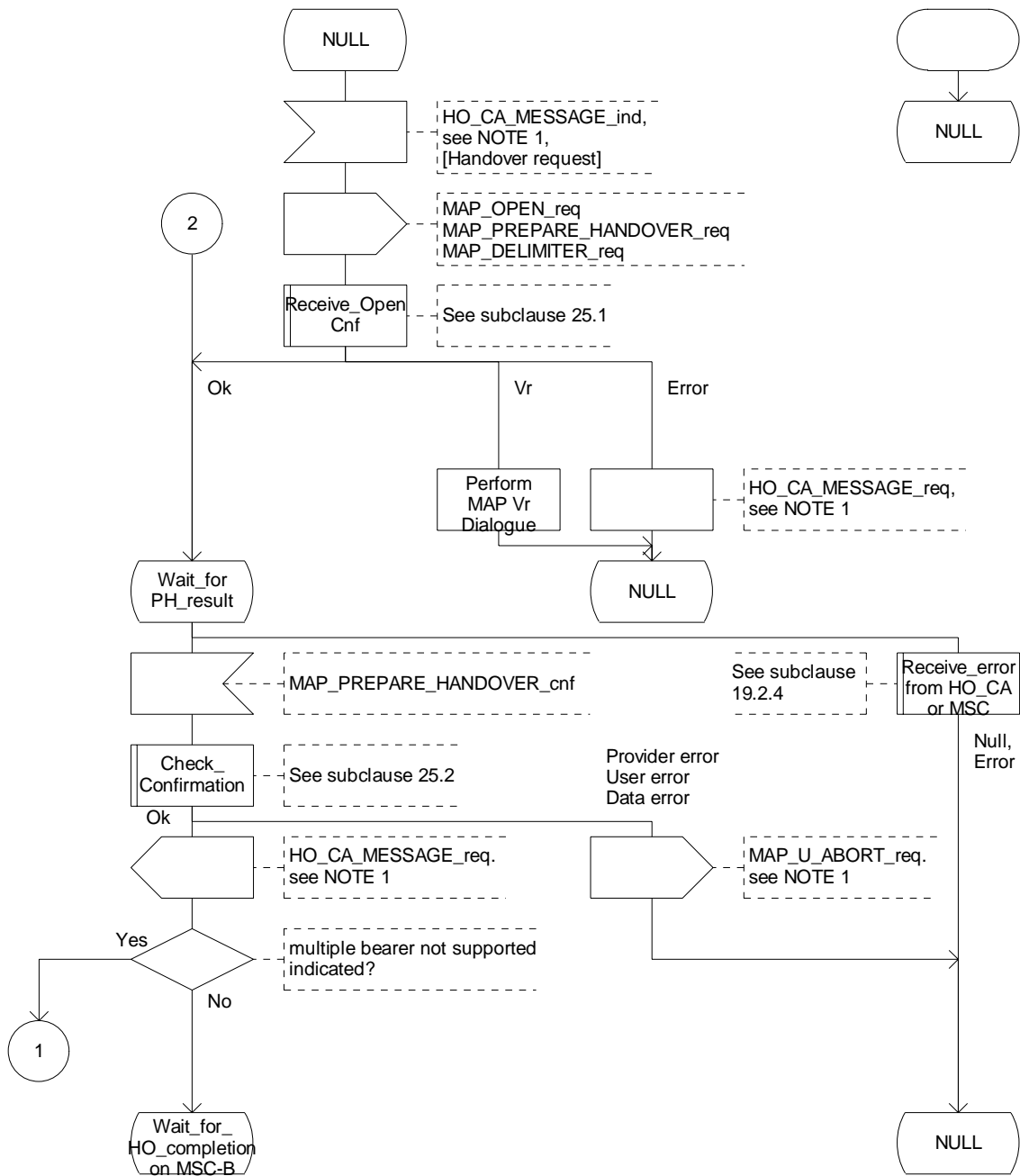

Figure 19.2.2/1 (sheet 1 of 13): Process MSC_A_HO

Figure 19.2 2/1: HO in MSC-A

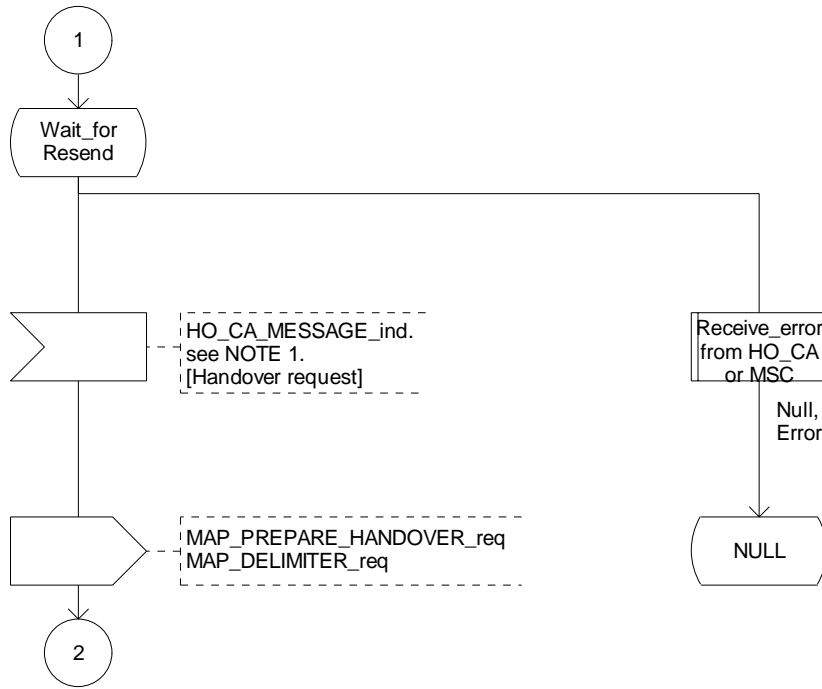

Figure 19.2.2/1 (sheet 2 of 13): Process MSC_A_HO

Figure 19.2 2/1: HO in MSC-A

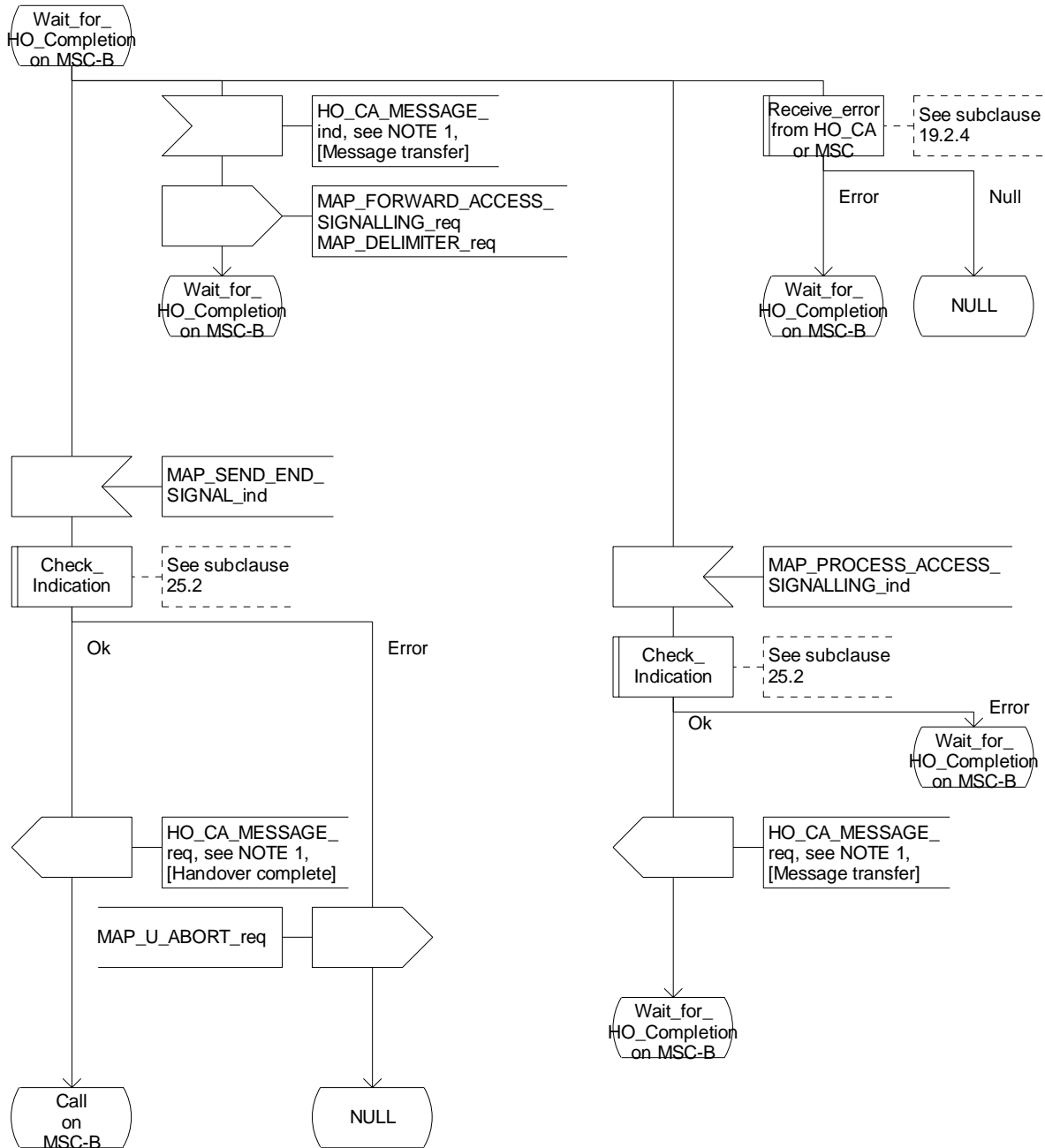

Figure 19.2.2/1 (sheet 3 of 13): Process MSC_A_HO

Figure 19.2 2/1: HO in MSC-A

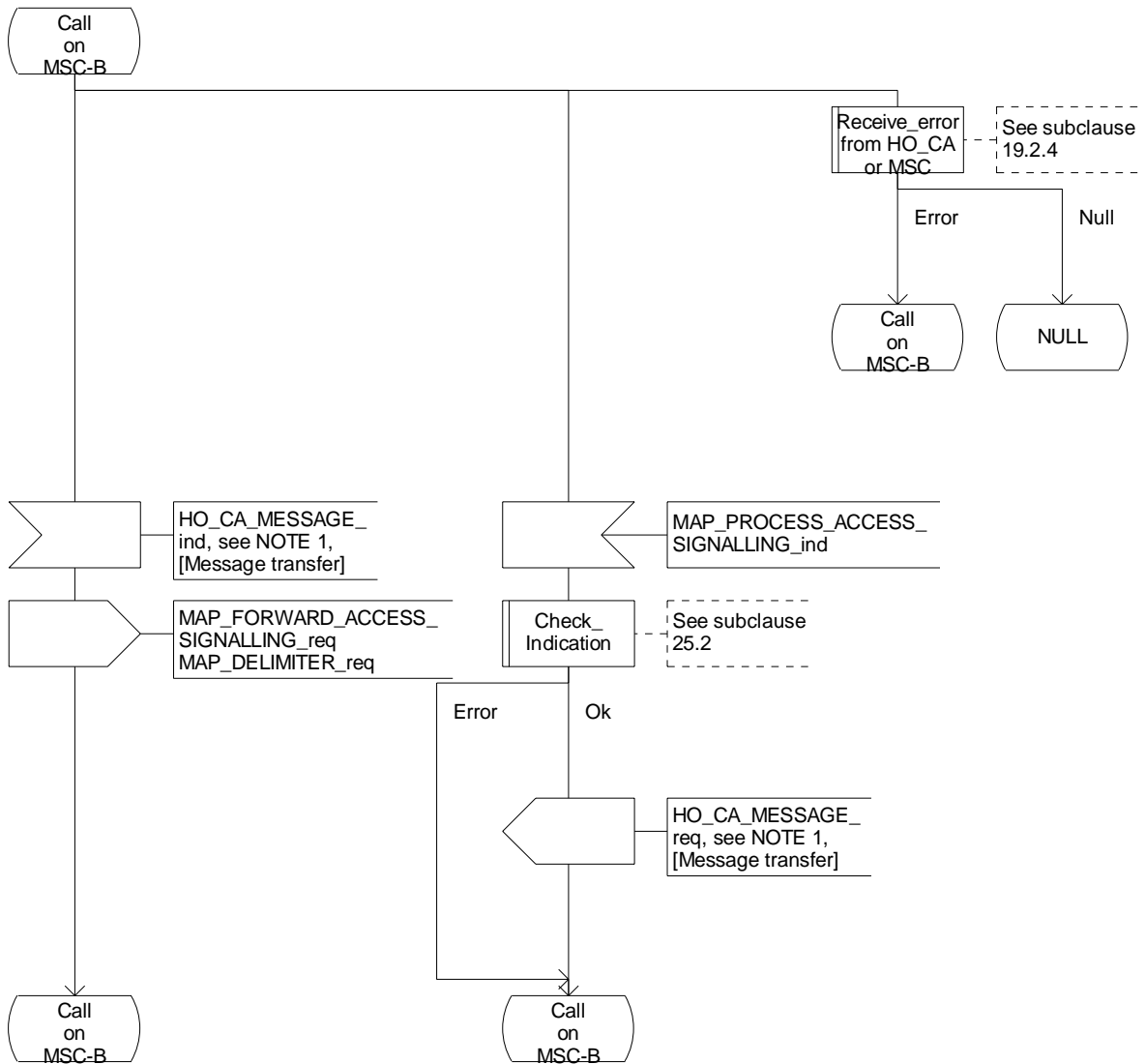

Figure 19.2.2/1 (sheet 4 of 13): Process MSC_A_HO

Figure 19.2 2/1: HO in MSC-A

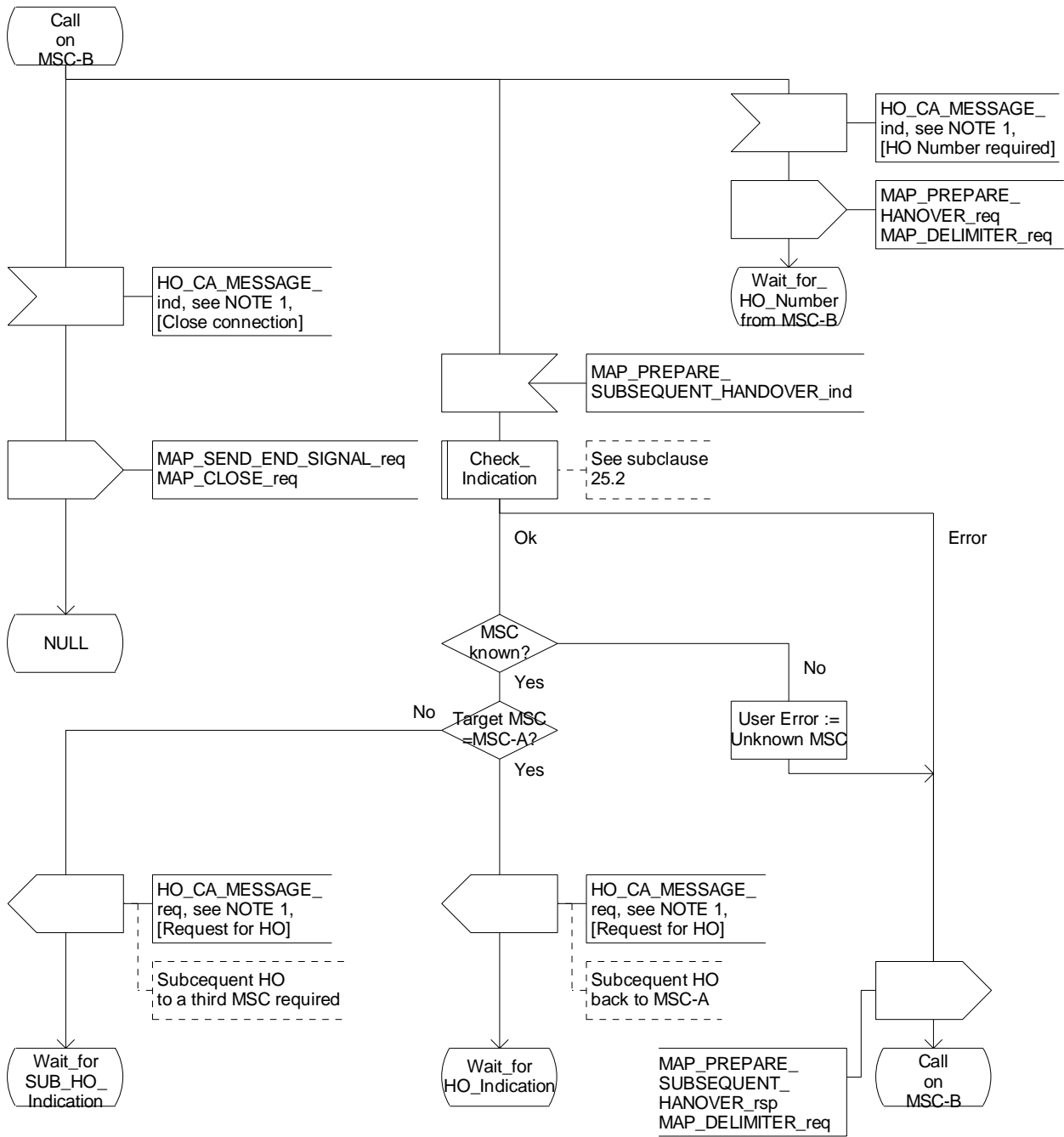

Figure 19.2 2/1: HO in MSC-A

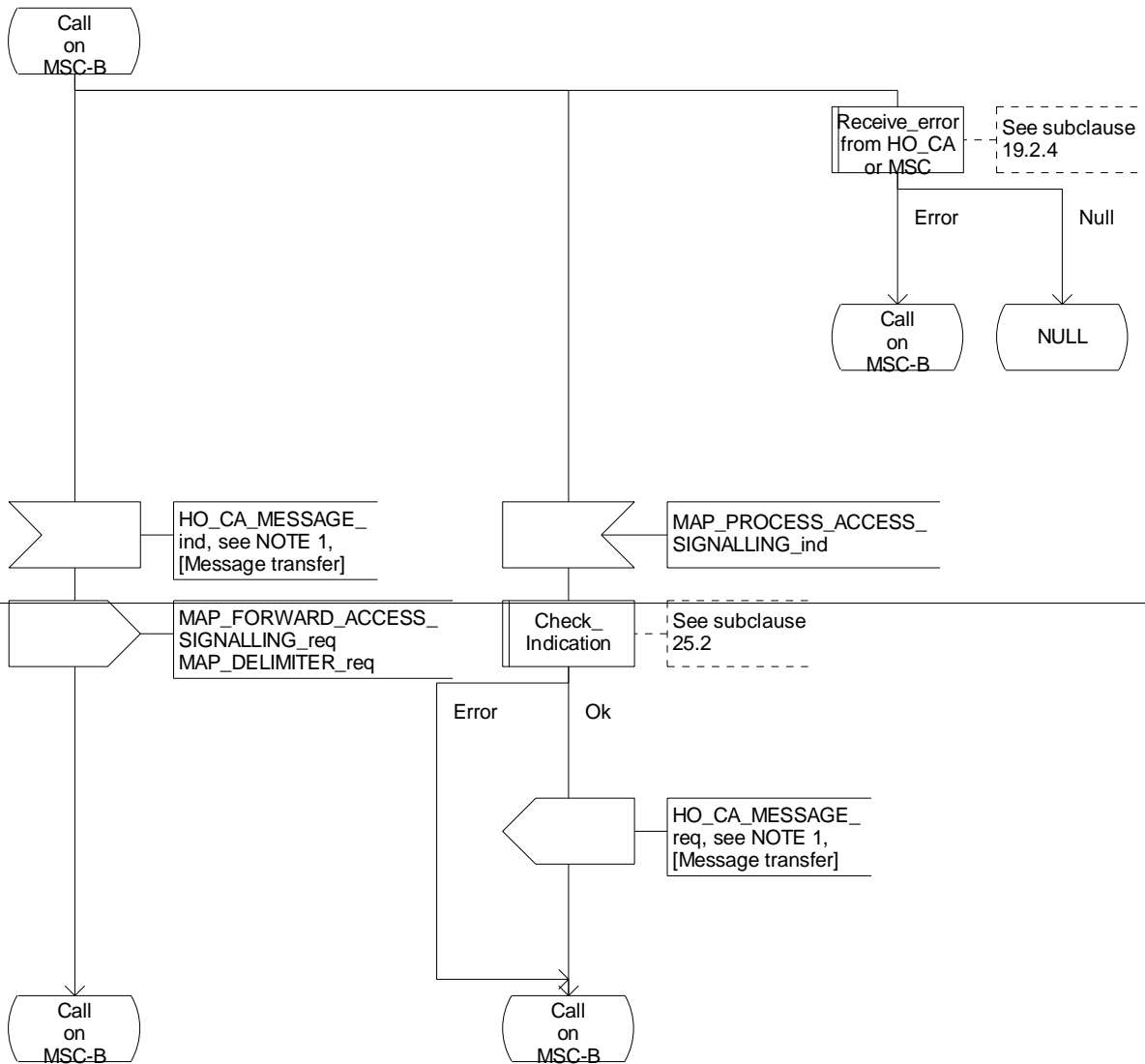

Figure 19.2.2/1 (sheet 5 of 13): Process MSC_A_HO

Figure 19.2 2/1: HO in MSC-A

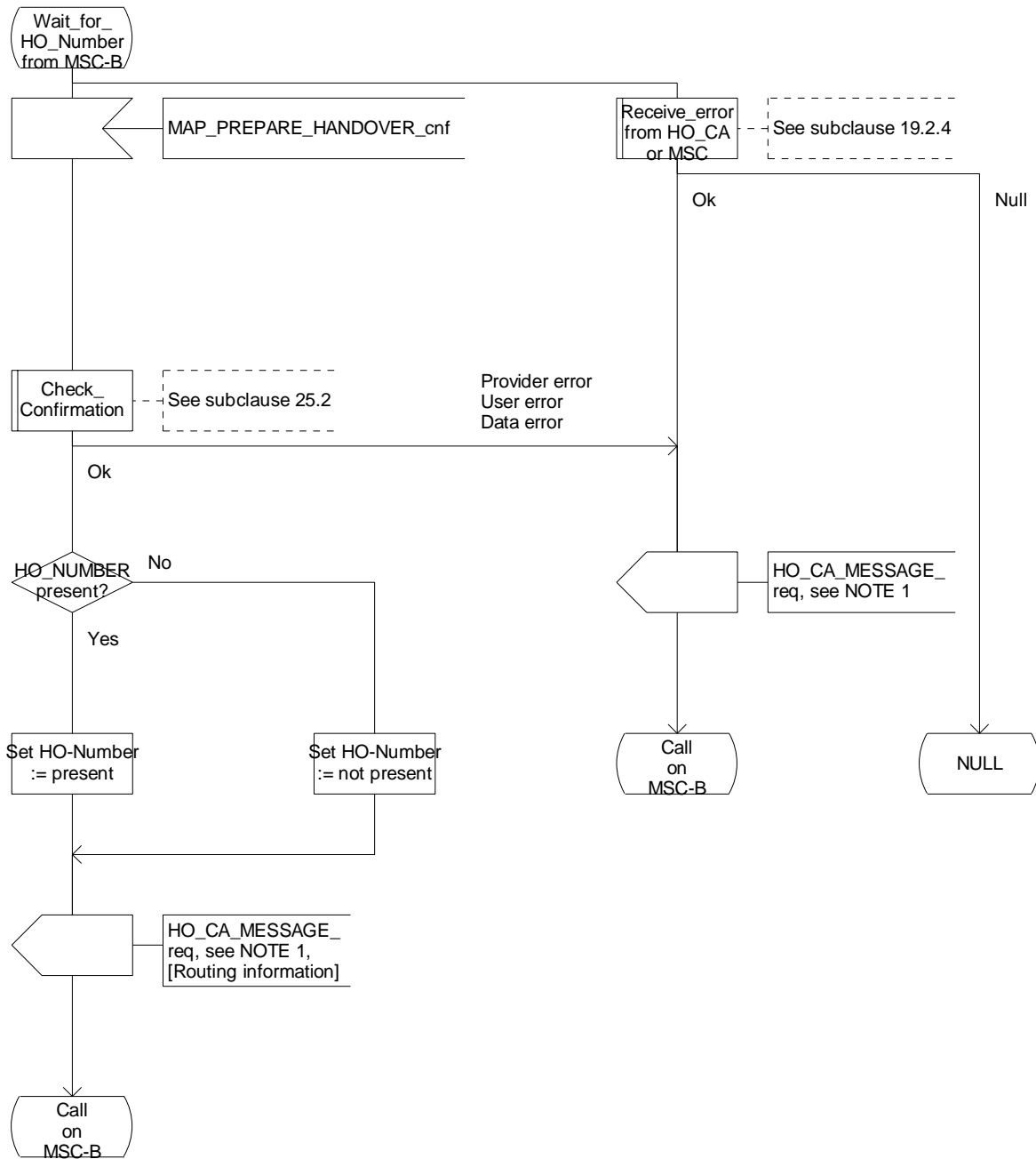

Figure 19.2.2/1 (sheet 6 of 13): Process MSC_A_HO

Figure 19.2 2/1: HO in MSC-A

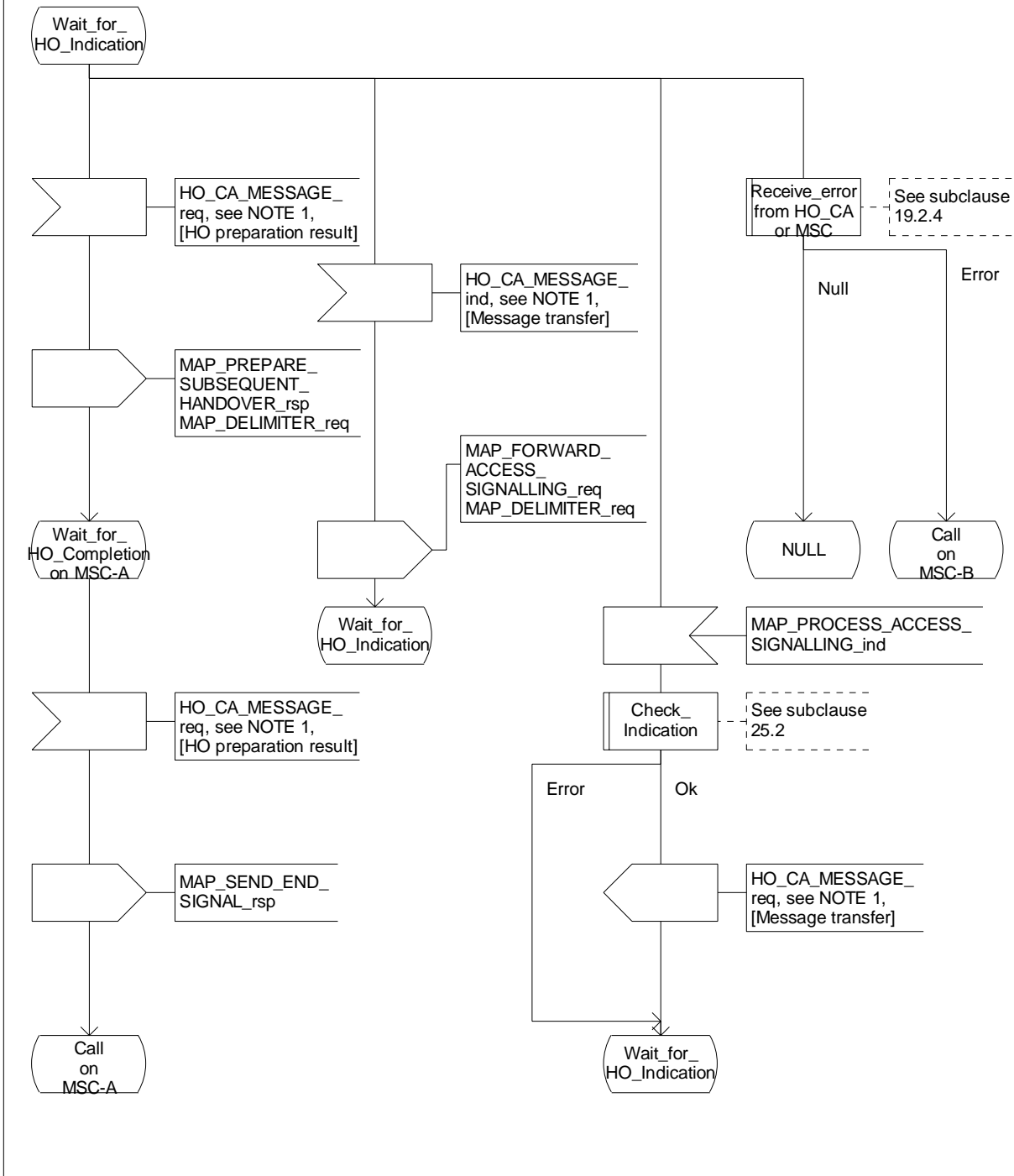

Figure 19.2.2/1 (sheet 7 of 13): Process MSC_A_HO

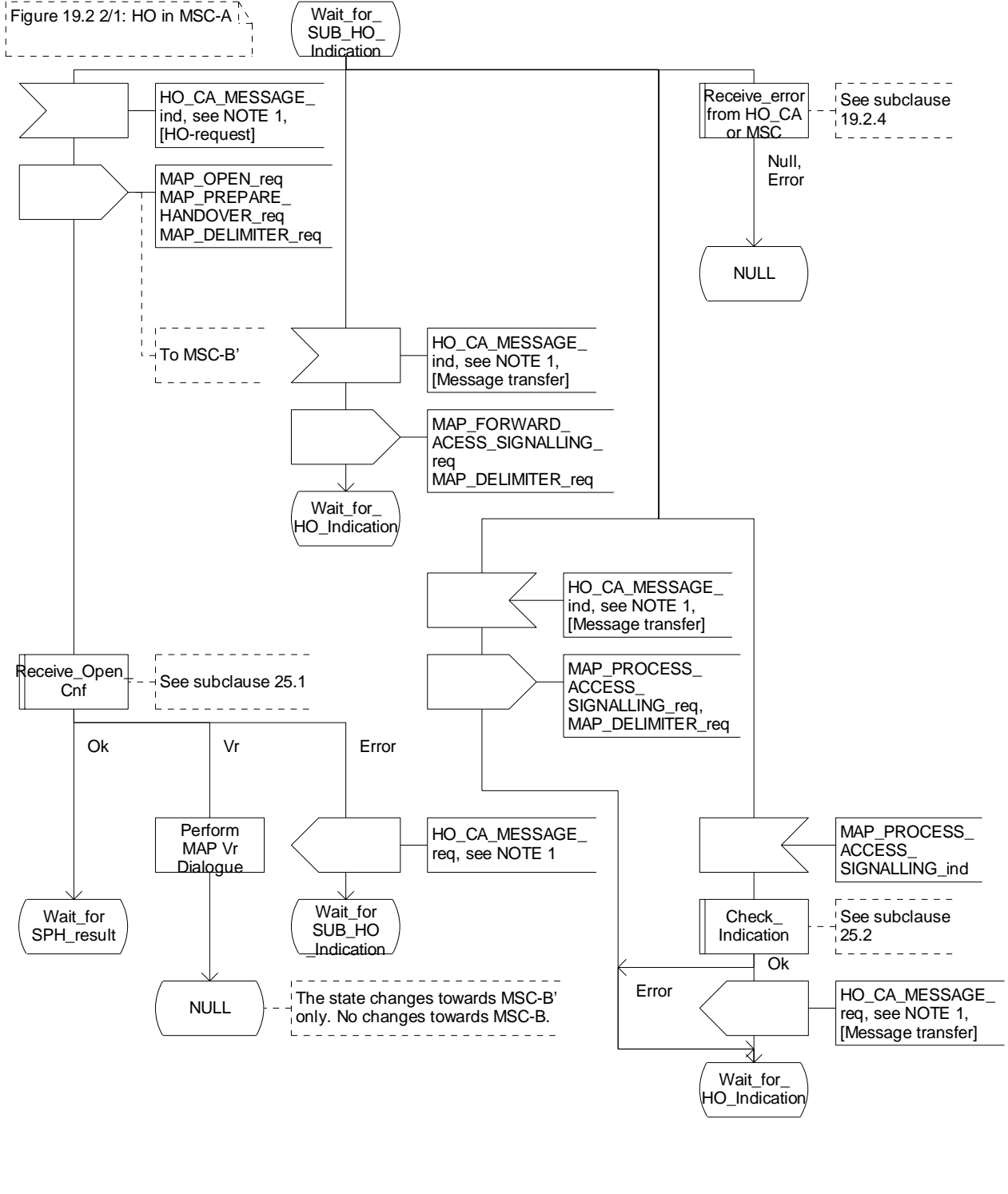
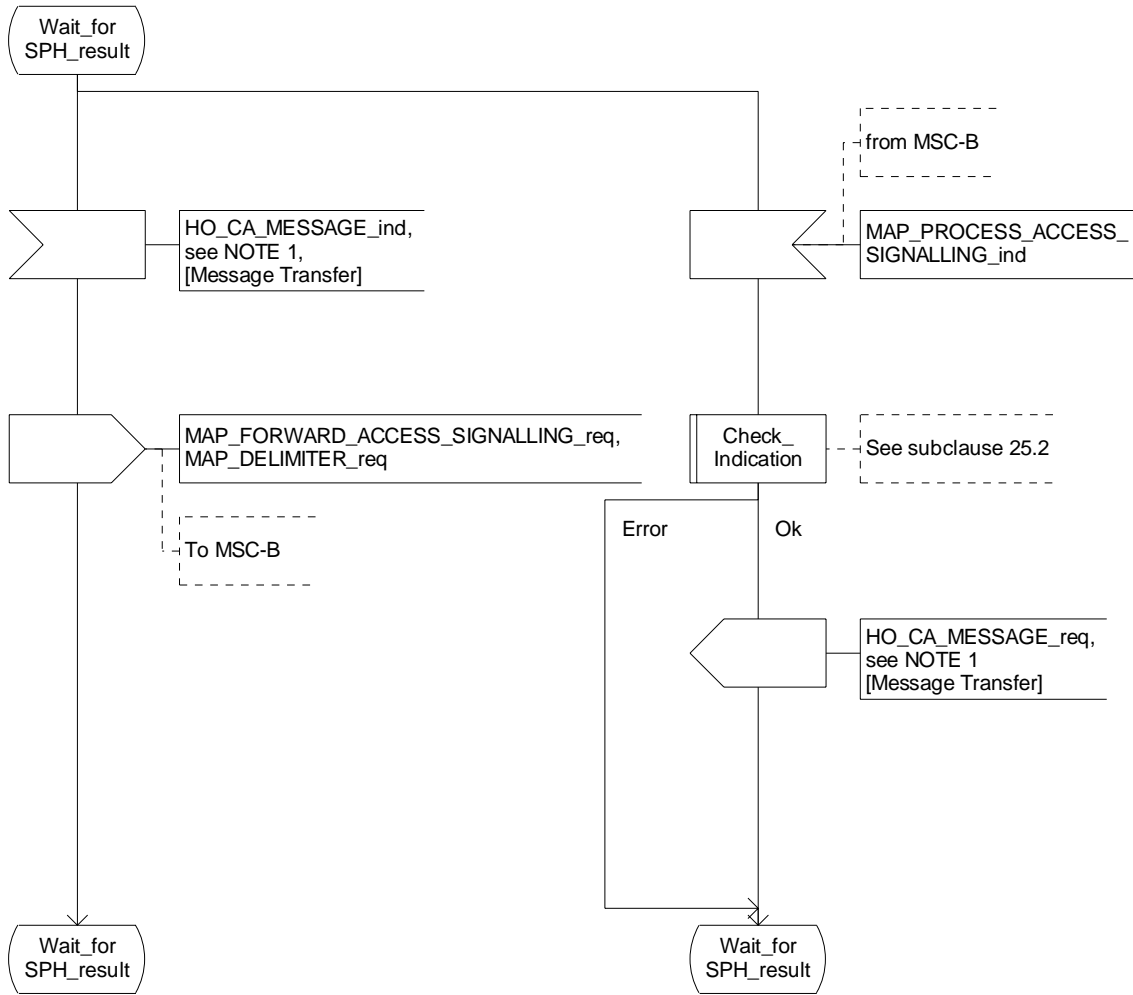

Figure 19.2.2/1 (sheet 8 of 13): Process MSC_A_HO

Figure 19.2 2/1: HO in MSC-A



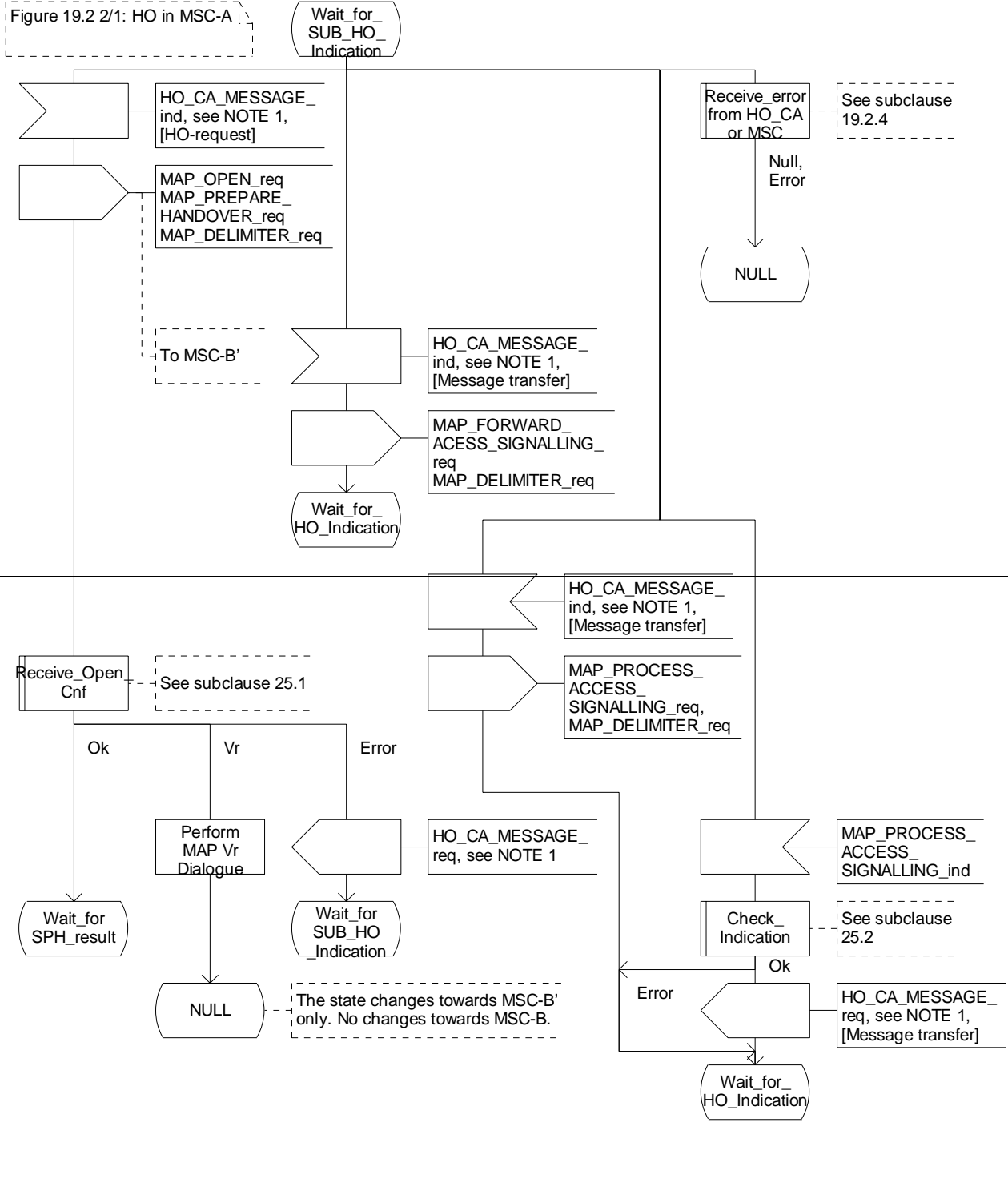

Figure 19.2.2/1 (sheet 9 of 13): Process MSC_A_HO

Figure 19.2 2/1: HO in MSC-A

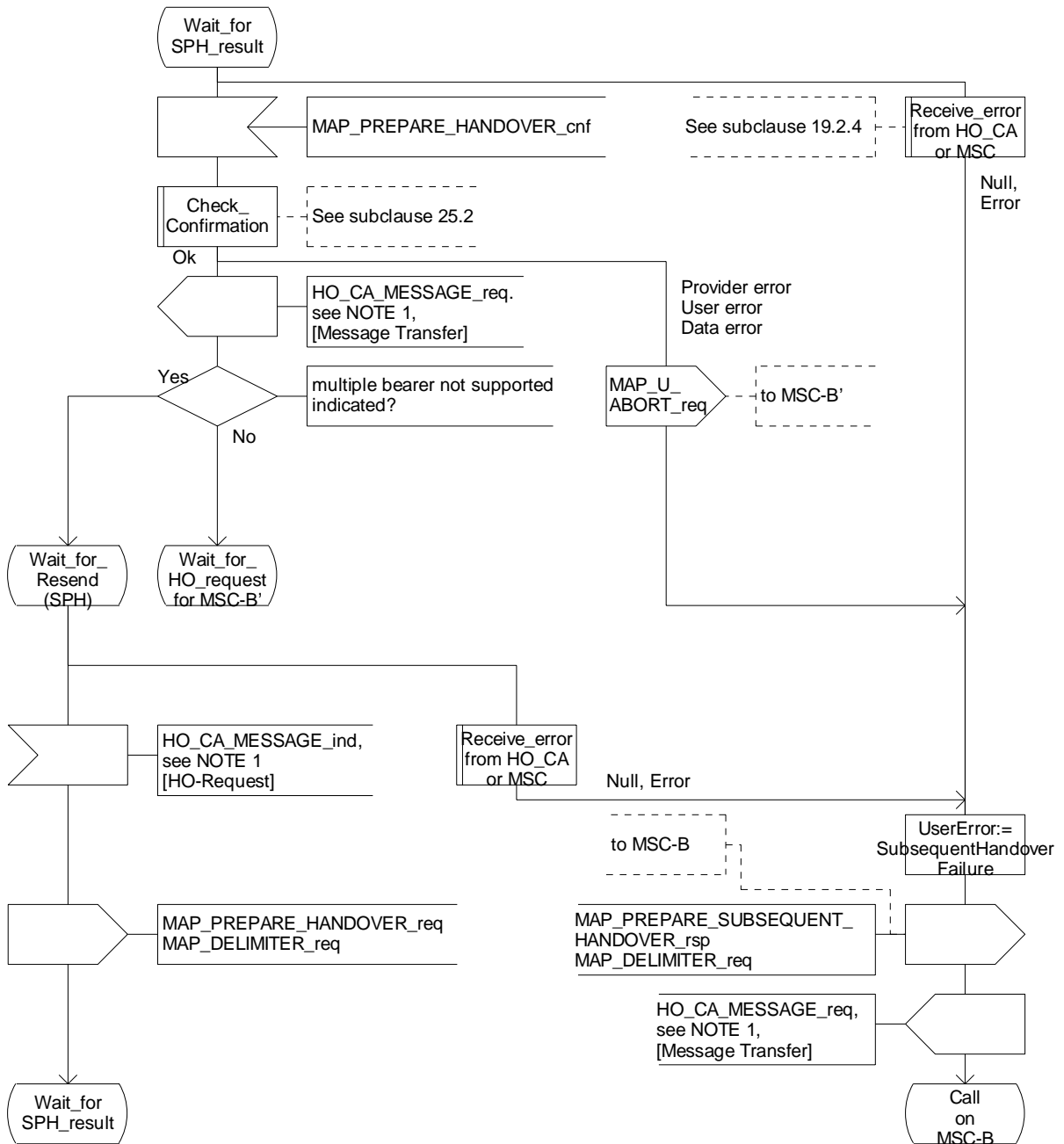

Figure 19.2.2/1 (sheet 10 of 13): Process MSC_A_HO

Figure 19.2 2/1: HO in MSC-A

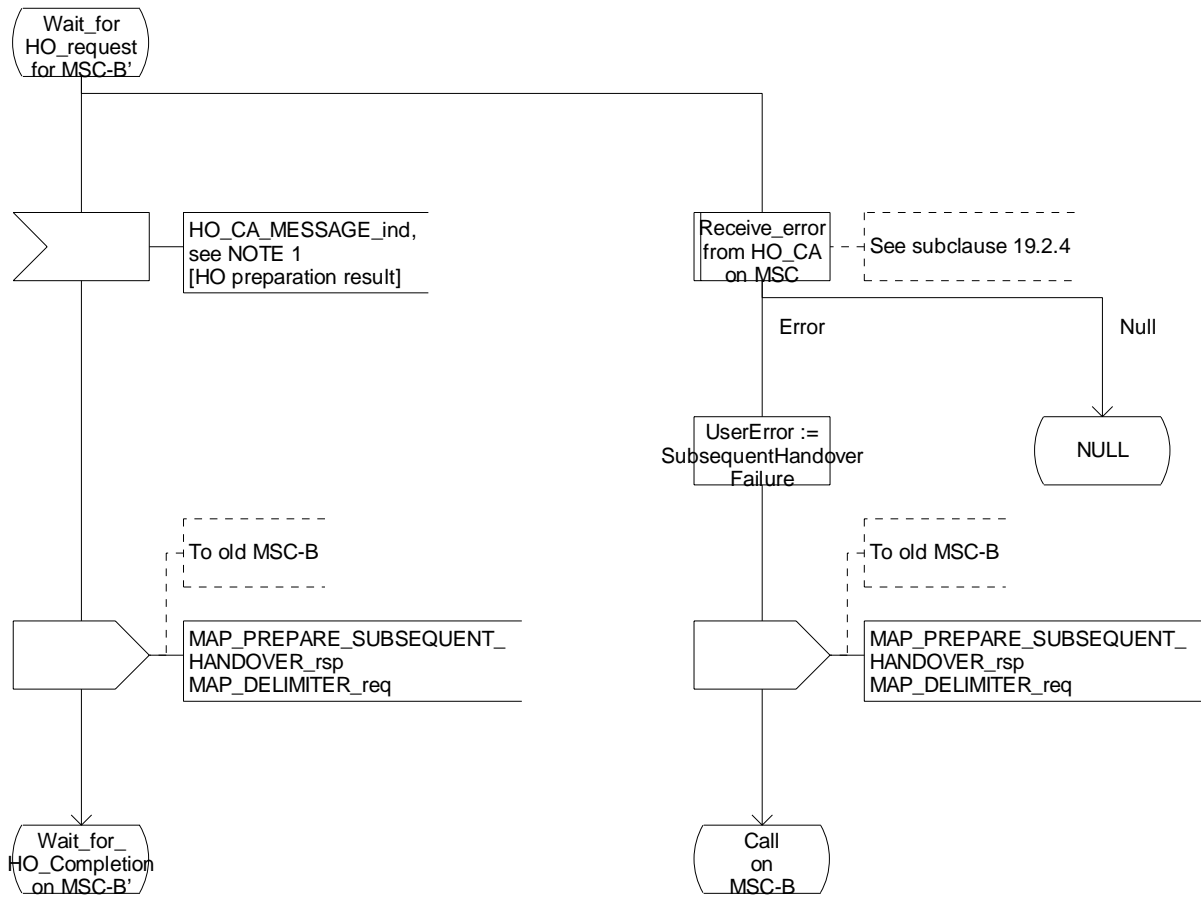

Figure 19.2.2/1 (sheet 11 of 13): Process MSC_A_HO

Figure 19.2 2/1: HO in MSC-A

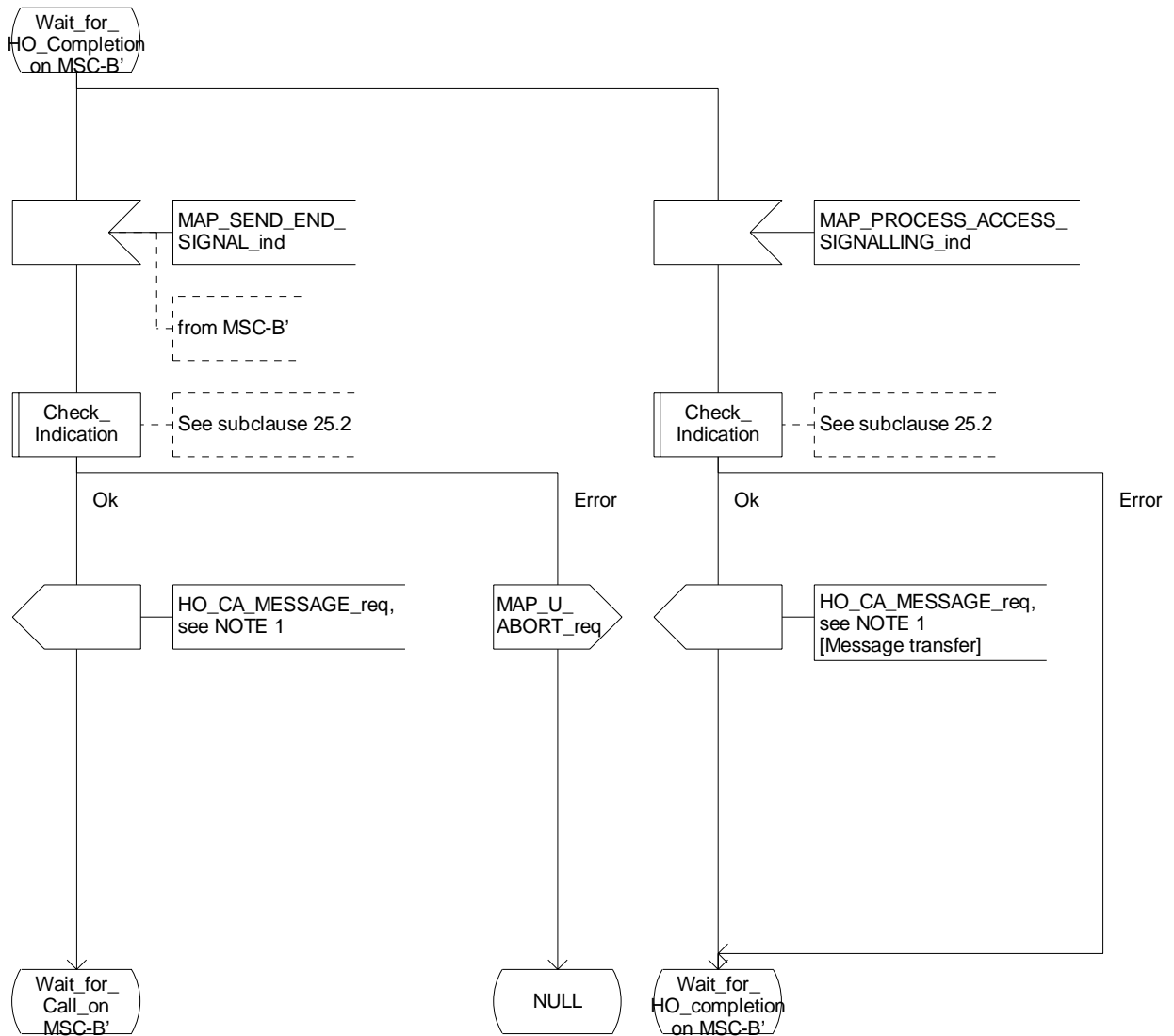

Figure 19.2.2/1 (sheet 12 of 13): Process MSC_A_HO

Figure 19.2 2/1: HO in MSC-A

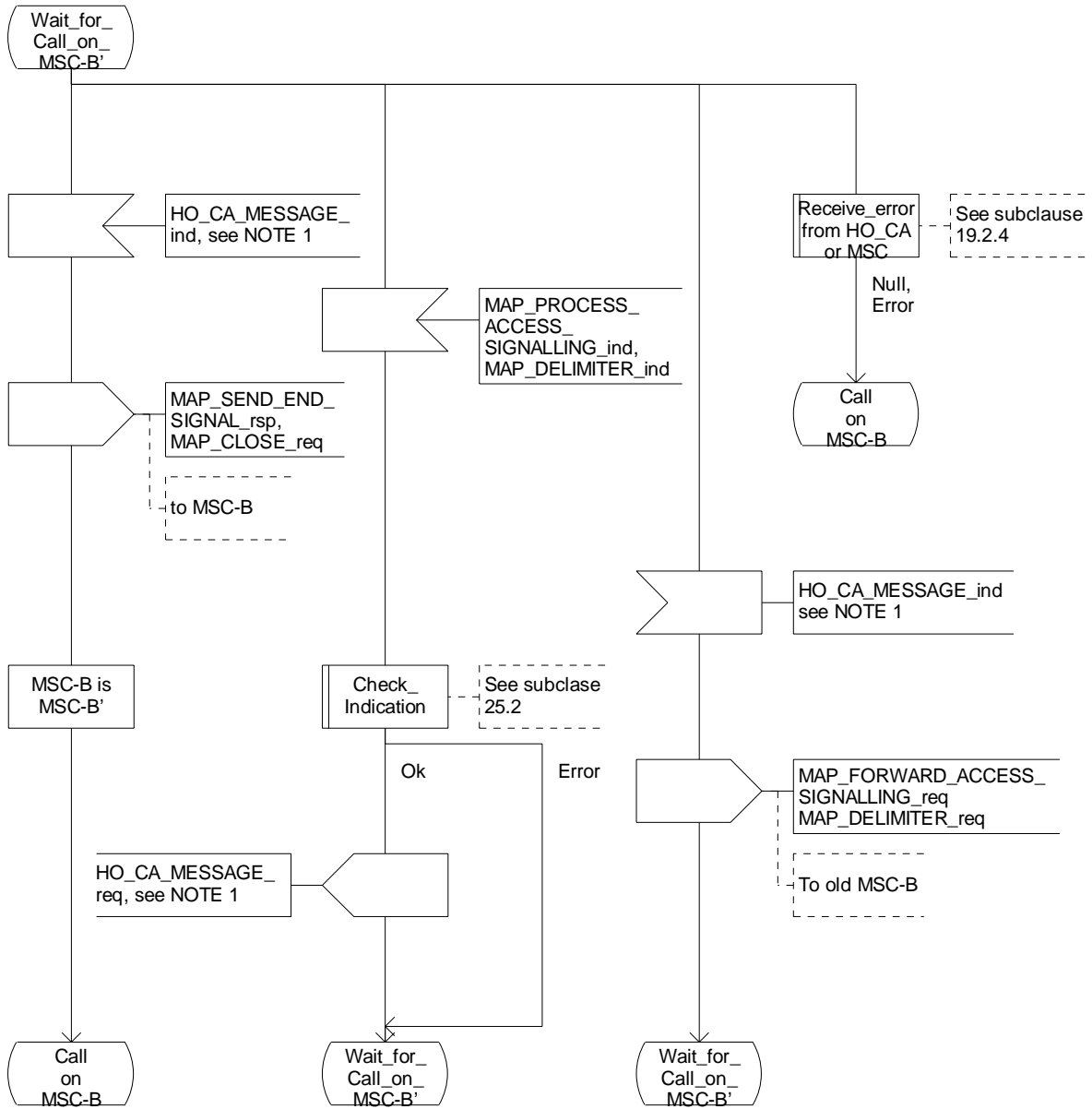

Figure 19.2.2/1 (sheet 13 of 13): Process MSC_A_HO

CHANGE REQUEST

29.002 CR 185

Current Version: 3.5.1

For submission to: TSG-CN#09 for approval for information strategic non-strategic

Proposed change affects: (U)SIM ME UTRAN / Radio Core Network

Source: N4 **Date:** 31th August 2000

Subject: Correction to MSC-A handover SDLs

Work item: TEI

Category:	F Correction	<input type="checkbox"/>	Release:	Phase 2	<input type="checkbox"/>
	A Corresponds to a correction in an earlier release	<input type="checkbox"/>		Release 96	<input type="checkbox"/>
	B Addition of feature	<input type="checkbox"/>		Release 97	<input type="checkbox"/>
	C Functional modification of feature	<input type="checkbox"/>		Release 98	<input type="checkbox"/>
	D Editorial modification	<input checked="" type="checkbox"/>		Release 99	<input checked="" type="checkbox"/>
				Release 00	<input type="checkbox"/>

Reason for change:

- The new figure 19.2.2/1 (sheet 8 of 13) seems to represent more than just editorial changes (as indicated by CR 143 coversheet)
- Replaced MAP_Prepare_Subsequent_Handover respond by MAP_forward_access_signalling Request
- Replaced Call on MSC-B by Wait_for_HO_indication
- Replaced Wait_for sub_ho_indication by Wait_for_Ho_indication

Clauses affected: 19.2.2.5

Other specs affected:	Other 3G core specifications	<input type="checkbox"/>	→ List of CRs:	
	Other GSM core specifications	<input type="checkbox"/>	→ List of CRs:	
	MS test specifications	<input type="checkbox"/>	→ List of CRs:	
	BSS test specifications	<input type="checkbox"/>	→ List of CRs:	
	O&M specifications	<input type="checkbox"/>	→ List of CRs:	

Other comments: Header for sheet 8 needs changing 19.2.2_1.7(12) -> 19.2.2_1.8(13)

Process MSC_A_HO

19.2.2_1.7(12)

Figure 19.2.2/1: HO in MSC-A'

