

**TSG-RAN Working Group 3 #7**  
**Sophia Antipolis, France, 20<sup>th</sup> - 24<sup>th</sup> September 1999**

*TSGW R3-(99a89)*

**Agenda:**

**Source:** Editor (CSELT)

**Title: 25.931 v1.2.1**  
**UTRAN Functions, Examples on Signalling Procedures**

*Note: This version includes (with revision marks) the updates and the modification agreed at the RAN WG3 meeting #5 (Helsinki July 99) and #6 (Sophia Antipolis August 99).*



# TR 25.931 V<1.2.1> (<1999-08>)

---

*Technical Specification*

**3<sup>rd</sup> Generation Partnership Project (3GPP);  
Technical Specification Group (TSG) RAN;**

**UTRAN Functions, Examples on Signalling Procedures**

---

**3GPP**



Reference

---

<Workitem> (<Shortfilename>.PDF)

Keywords

---

<keyword[, keyword]>

**3GPP**

Postal address

---

Office address

---

Internet

---

secretariat@3gpp.org  
Individual copies of this deliverable  
can be downloaded from  
<http://www.3gpp.org>

---

**Copyright Notification**

---

No part may be reproduced except as authorized by written permission.  
The copyright and the foregoing restriction extend to reproduction in all media.

©  
All rights reserved.

# Contents

1. Intellectual Property Rights .....	11
2. Foreword .....	11
3. Scope .....	11
4. References .....	11
5. Definitions, abbreviations and notation .....	12
5.1 Definitions .....	12
5.2 Abbreviations .....	12
5.3 Notation for the signalling procedures .....	12
6. UTRAN and UE protocol Architecture .....	14
6.1 Protocol Architecture .....	14
6.2 RANAP Procedures & Messages .....	15
6.3 RNSAP Procedures & Messages .....	16
6.4 NBAP Procedures & Messages .....	16
6.5 ALCAP .....	17
6.5.1 Q2630.1 (Q.AAL 2) .....	17
6.6 RRC Procedures & Messages .....	18
7. UTRAN Signaling Procedures .....	20
8. Procedures not related to a specific UE (global procedures) .....	20
8.1 System Information Broadcasting .....	20
8.2 Cell Broadcast .....	20
9. Procedures related to a specific UE .....	20
9.1 Paging .....	21
9.1.1 Paging for a UE in RRC Idle Mode .....	21
9.1.2 Paging for a UE in RRC Connected Mode .....	21
9.2 NAS Signalling Connection Establishment .....	22
9.2.1 UE Initiated Signalling Connection Establishment .....	22
9.2.2 CN Initiated Signalling Connection Establishment .....	23
9.3 RRC Connection Establishment .....	23
9.3.1 DCH Establishment .....	23
9.3.2 RACH/FACH Establishment .....	24
9.4 RRC Connection Release .....	24
9.4.1 DCH Release .....	24
9.4.2 Common Transport Channel Release .....	25
9.5 RRC Connection Re-establishment .....	25
9.5.1 DCH Re-establishment .....	25
9.5.2 RACH/FACH Re-establishment .....	28
9.6 Radio Access Bearer Establishment .....	28
9.6.1 DCH - DCH Establishment - Synchronized .....	28
9.6.2 DCH - DCH Establishment - Unsynchronized (PSTN/ISDN Core Network) .....	30
9.6.3 RACH/FACH - DCH Establishment .....	32
9.6.4 RACH/FACH - RACH/FACH Establishment .....	33
9.7 Radio Access Bearer Release .....	33
9.7.1 DCH - DCH Release - Synchronized .....	33
9.7.2 DCH - DCH Release - Unsynchronized .....	35
9.7.3 DCH - RACH/FACH Release .....	37
9.7.4 RACH/FACH - RACH/FACH Release .....	37
9.8 Radio Access Bearer Re-establishment .....	37
9.8.1 DCH - DCH Re-establishment .....	37
9.8.2 RACH/FACH - DCH Re-establishment .....	37

9.8.3	RACH/FACH - RACH/FACH Re-establishment .....	38
9.9	Radio Access Bearer Modification .....	38
9.9.1	DCH to DCH Modification .....	39
9.9.2	RACH/FACH TO RACH/FACH Reconfiguration.....	40
9.9.3	RACH/FACH TO DCH Reconfiguration.....	40
9.9.4	DCH TO RACH/FACH RECONFIGURATION.....	41
9.10	Physical Channel Reconfiguration .....	42
9.10.1	Physical Channel Reconfiguration (DCH).....	42
9.10.2	Physical Channel Reconfiguration (CRNC Controlled) .....	43
9.11	Channel Type Switching .....	44
9.11.1	RACH/PCH to RACH/FACH .....	44
9.11.2	RACH/FACH to RACH/PCH .....	45
9.11.3	RACH/FACH to DCH.....	45
9.11.4	DCH to RACH/FACH.....	46
9.12	Soft Handover.....	46
9.12.1	Radio Link Addition (Branch Addition).....	47
9.12.2	Radio link Deletion (Branch Deletion).....	48
9.12.3	Radio link Addition & Deletion (Branch Addition & Deletion - simultaneously).....	49
9.13	Hard Handover.....	50
9.13.1	Backward Hard Handover.....	50
9.13.2	Forward Hard Handover.....	56
9.14	URA Update .....	60
9.14.1	Inter-RNS URA Update with SRNS Relocation.....	60
9.14.2	Inter-RNS URA Update via Iur without SRNS relocation .....	61
9.14.3	SRNS Relocation (UE connected to two CN nodes).....	62
9.15	HO between UTRAN and GSM/BSS .....	63
9.15.1	UTRAN ⇒ GSM/BSS .....	64
9.15.2	GSM/BSS ⇒ UTRAN .....	65
9.15.3	GPRS ⇒ UTRAN .....	67
9.15.4	UTRAN ⇒ GPRS, UE Initiated.....	67
9.15.5	UTRAN ⇒ GPRS, Network Initiated .....	68
9.16	Load Indication .....	68
9.17	Ciphering .....	68
9.18	Transport CH Reconfiguration.....	69
9.18.1	Transport CH Reconfiguration (Dedicated CH to Dedicated CH) .....	69
9.18.2	Transport CH Reconfiguration (RACH/FACH to RACH/FACH) .....	73
9.18.3	Transport CH Reconfiguration (RACH/FACH to Dedicated CH) .....	74
9.18.4	Transport CH Reconfiguration (Dedicated CH to RACH/FACH) .....	75
9.19	Notification .....	76
9.20	DL Code Reconfiguration .....	77
9.21	Direct Transfer.....	78
9.21.1	Uplink Direct Transfer .....	78
9.21.2	Downlink Direct Transfer.....	79
9.22	Downlink Power Control .....	80
1	Annex B (Informative and temporary) Document Stability Assessment Table.....	88
1.	Intellectual Property Rights .....	9
2.	Foreword .....	9
3.	Scope .....	9
4.	References .....	9
5.	Definitions, abbreviations and notation .....	10
5.1	Definitions .....	10
5.2	Abbreviations .....	10
5.3	Notation for the signalling procedures .....	10
6.	UTRAN and UE protocol Architecture .....	12
6.1	Protocol Architecture .....	12
6.2	RANAP Procedures & Messages.....	13

6.3	RNSAP Procedures & Messages	13
6.4	NBAP Procedures & Messages	14
6.5	ALCAP	14
6.5.1	Q2630.1 (Q.AAL 2)	14
6.6	RRC Procedures & Messages	15
7	UTRAN Signaling Procedures	16
8	Procedures not related to a specific UE (global procedures)	16
8.1	System Information Broadcasting	16
8.2	Cell Broadcast	16
9	Procedures related to a specific UE	16
9.1	Paging	16
9.1.1	Paging for a UE in RRC Idle Mode	17
9.1.2	Paging for a UE in RRC Connected Mode	17
9.2	NAS Signalling Connection Establishment	18
9.2.1	UE Initiated Signalling Connection Establishment	18
9.2.2	CN Initiated Signalling Connection Establishment	18
9.3	RRC Connection Establishment	18
9.3.1	DCH Establishment	18
9.3.2	RACH/FACH Establishment	19
9.4	RRC Connection Release	19
9.4.1	DCH Release	20
9.4.2	Common Transport Channel Release	20
9.5	RRC Connection Re-establishment	20
9.5.1	DCH Re-establishment	20
9.5.2	RACH/FACH Re-establishment	23
9.6	Radio Access Bearer Establishment	23
9.6.1	DCH DCH Establishment Synchronized	23
9.6.2	DCH DCH Establishment Unsynchronized (PSTN/ISDN Core Network)	25
9.6.3	RACH/FACH DCH Establishment	27
9.6.4	RACH/FACH RACH/FACH Establishment	28
9.7	Radio Access Bearer Release	28
9.7.1	DCH DCH Release Synchronized	28
9.7.2	DCH DCH Release Unsynchronized	30
9.7.3	DCH RACH/FACH Release	31
9.7.4	RACH/FACH RACH/FACH Release	31
9.8	Radio Access Bearer Re-establishment	31
9.8.1	DCH DCH Re-establishment	32
9.8.2	RACH/FACH DCH Re-establishment	32
9.8.3	RACH/FACH RACH/FACH Re-establishment	32
9.9	Radio Access Bearer Modification	32
9.9.1	DCH to DCH Modification	33
9.9.2	RACH/FACH TO RACH/FACH Reconfiguration	34
9.9.3	RACH/FACH TO DCH Reconfiguration	34
9.9.4	DCH TO RACH/FACH RECONFIGURATION	35
9.10	Physical Channel Reconfiguration	36
9.10.1	Physical Channel Reconfiguration (DCH)	36
9.10.2	Physical Channel Reconfiguration (CRNC Controlled)	37
9.11	Channel Type Switching	38
9.11.1	RACH/PCH to RACH/FACH	38
9.11.2	RACH/FACH to RACH/PCH	39
9.11.3	RACH/FACH to DCH	39
9.11.4	DCH to RACH/FACH	40
9.12	Soft Handover	40
9.12.1	Radio Link Addition (Branch Addition)	40
9.12.2	Radio link Deletion (Branch Deletion)	42
9.12.3	Radio link Addition & Deletion (Branch Addition & Deletion simultaneously)	42
9.13	Hard Handover	43
9.13.1	Backward Hard Handover	43

9.13.2	Forward Hard Handover	49
9.14	URA Update	52
9.14.1	Inter RNS URA Update with SRNS Relocation	52
9.14.2	Inter RNS URA Update via Iur without SRNS relocation	53
9.14.3	SRNS Relocation (UE connected to two CN nodes)	54
9.15	HO between UTRAN and GSM/BSS	56
9.15.1	UTRAN $\Rightarrow$ GSM/BSS	56
9.15.2	GSM/BSS $\Rightarrow$ UTRAN	58
9.15.3	GPRS $\Rightarrow$ UTRAN	59
9.15.4	UTRAN $\Rightarrow$ GPRS, UE Initiated	59
9.15.5	UTRAN $\Rightarrow$ GPRS, Network Initiated	59
9.16	Load Indication	60
9.17	Ciphering	60
9.18	Transport CH Reconfiguration	61
9.18.1	Transport CH Reconfiguration (Dedicated CH to Dedicated CH)	61
9.18.2	Transport CH Reconfiguration (RACH/FACH to RACH/FACH)	65
9.18.3	Transport CH Reconfiguration (RACH/FACH to Dedicated CH)	66
9.18.4	Transport CH Reconfiguration (Dedicated CH to RACH/FACH)	67
9.19	Notification	68
9.20	DL Code Reconfiguration	69
9.21	Direct Transfer	70
9.21.1	Uplink Direct Transfer	70
9.22	Downlink Direct Transfer	71
9.23	Downlink Power Control	72
10.	ANNEX: status of the document	78
1.	Intellectual Property Rights	7
2.	Foreword	7
3.	Scope	7
4.	References	7
5.	Definitions, abbreviations and notation	8
5.1	Definitions	8
5.2	Abbreviations	8
5.3	Notation for the signalling procedures	8
6.	UTRAN AND UE PROTOCOL ARCHITECTURE	10
6.1	Protocol Architecture	10
6.2	RANAP Procedures & Messages	11
6.3	RNSAP Procedures & Messages	11
6.4	NBAP Procedures & Messages	12
6.5	ALCAP	12
6.5.1	Q2630.1 (Q.AAL 2)	12
6.6	RRC Procedures & Messages	13
7.	UTRAN Signaling Procedures	14
8.	Procedures not related to a specific UE (global procedures)	14
8.1	System Information Broadcasting	14
9.	Procedures related to a specific UE	14
9.1	Paging	14
9.1.1	Paging for a UE in RRC Idle Mode	15
9.1.2	Paging for a UE in RRC Connected Mode	15
9.2	NAS Signalling Connection Establishment	16
9.2.1	UE Initiated Signalling Connection Establishment	16
9.2.2	CN Initiated Signalling Connection Establishment	16
9.3	RRC Connection Establishment	16
9.3.1	DCH Establishment	16
9.3.2	RACH/FACH Establishment	17



9.4	RRC Connection Release	17	
9.4.1	DCH Release	18	18
9.4.2	Common Transport Channel Release	18	
9.5	RRC Connection Re-establishment	18	
9.5.1	DCH Re-establishment	18	
9.5.2	RACH/FACH Re-establishment	20	
9.6	Radio Access Bearer Establishment	20	
9.6.1	DCH DCH Establishment Synchronized	20	
9.6.2	DCH DCH Establishment Unsynchronized (PSTN/ISDN Core Network)	22	
9.6.3	RACH/FACH DCH Establishment	23	
9.6.4	RACH/FACH RACH/FACH Establishment	24	
9.7	Radio Access Bearer Release	24	
9.7.1	DCH DCH Release Synchronized	24	
9.7.2	DCH DCH Release Unsynchronized	26	
9.7.3	DCH RACH/FACH Release	27	
9.7.4	RACH/FACH RACH/FACH Release	27	
9.8	Radio Access Bearer Re-establishment	27	
9.8.1	DCH DCH Re-establishment	28	
9.8.2	RACH/FACH DCH Re-establishment	28	
9.8.3	RACH/FACH RACH/FACH Re-establishment	28	
9.9	Radio Access Bearer Modification	28	
9.9.1	DCH to DCH Modification	29	
9.9.2	RACH/FACH TO RACH/FACH Reconfiguration	30	
9.9.3	RACH/FACH TO DCH Reconfiguration	30	
9.9.4	DCH TO RACH/FACH RECONFIGURATION	31	
9.10	Physical Channel Reconfiguration	32	
9.11	Channel Type Switching	32	
9.11.1	RACH/PCH to RACH/FACH	32	
9.11.2	RACH/FACH to RACH/PCH	33	
9.11.3	RACH/FACH to DCH	33	
9.11.4	DCH to RACH/FACH	34	
9.12	Soft Handover	34	
9.12.1	Radio Link Addition (Branch Addition)	34	
9.12.2	Radio link Deletion (Branch Deletion)	35	
9.12.3	Radio link Addition & Deletion (Branch Addition & Deletion simultaneously)	36	
9.13	Hard Handover	37	
9.13.1	Backward Hard Handover	37	
9.13.2	Forward Hard Handover	43	
9.14	URA Update	45	
9.14.1	Inter-RNS URA Update with SRNS Relocation	45	
9.14.2	Inter-RNS URA Update via Iur without SRNS relocation	46	
9.14.3	SRNS Relocation (UE connected to two CN nodes)	47	
9.15	HO between UTRAN and GSM/BSS	49	
9.15.1	UTRAN ⇒ GSM/BSS	49	
9.15.2	GSM/BSS ⇒ UTRAN	51	
9.15.3	UTRAN ⇒ GPRS	52	
9.15.4	UTRAN ⇒ GSM/BSS	53	
9.16	Load Indication	53	
9.17	Ciphering	53	
9.18	Transport CH Reconfiguration	54	
9.18.1	Transport CH Reconfiguration (Dedicated CH to Dedicated CH)	54	
9.18.2	Transport CH Reconfiguration (RACH/FACH to RACH/FACH)	55	
9.18.3	Transport CH Reconfiguration (RACH/FACH to Dedicated CH)	56	
9.18.4	Transport CH Reconfiguration (Dedicated CH to RACH/FACH)	57	
9.19	Notification	58	
9.20	DL Code Reconfiguration	59	
9.21	Direct Transfer	60	
9.21.1	Uplink Direct Transfer	60	
9.21.2	Downlink Direct Transfer	61	
9.22	Downlink Power Control	62	

10. ANNEX: status of the document ..... 67

---

# Intellectual Property Rights

## Foreword

This Technical Specification has been produced by the 3<sup>rd</sup> Generation Partnership Project, Technical Specification Group RAN.

The contents of this TR may be subject to continuing work within the 3GPP and may change following formal TSG approval. Should the TSG modify the contents of this TR, it will be re-released with an identifying change of release date and an increase in version number as follows:

Version m.t.e

where:

- m indicates [major version number]
- x the second digit is incremented for all changes of substance, i.e. technical enhancements, corrections, updates, etc.
- y the third digit is incremented when editorial only changes have been incorporated into the specification.

---

## Scope

This document describes the UTRAN functions by means of signalling procedure examples (Message Sequence Charts). The signalling procedure examples show the interaction between the UE, the different UTRAN nodes and the CN to perform system functions. This gives an overall understanding of how the UTRAN works in example scenarios

---

## References

References may be made to:

- a) specific versions of publications (identified by date of publication, edition number, version number, etc.), in which case, subsequent revisions to the referenced document do not apply;
- b) all versions up to and including the identified version (identified by "up to and including" before the version identity);
- c) all versions subsequent to and including the identified version (identified by "onwards" following the version identity); or
- d) publications without mention of a specific version, in which case the latest version applies.

A non-specific reference to an ETS shall also be taken to refer to later versions published as an EN with the same number.

[5] 25.931 UTRAN Overall Description

[6] 25.414 UTRAN I<sub>u</sub> Interface RANAP Signalling

- [7] 25.424 UTRAN I<sub>ur</sub> Interface RNSAP Signalling
- [8] 25.434 UTRAN I<sub>ub</sub> Interface NBAP Signalling
- [9] 25.832 Manifestations of Handover and SRNS Relocation
- [10] UMTS YY.01 MS-UTRAN Radio Interface Protocol Architecture
- [14] UMTS YY.31 Description of RRC protocol

Editor note: reference [10] and [14] should be updated, the numbering will be updated when the list will be stable

---

## Definitions, abbreviations and notation

### Definitions

Refer to [5].

### 4.2 Abbreviations

For the purposes of this specification the following abbreviations apply.

ALCAP	Access Link Control Application Part
AS	Access Stratum
BSSMAP	Base Station System Management Application Part
CN	Core Network
CRNC	Controlling RNC
DCH	Dedicated Channel
DRNS	Drift RNS
L1	Layer 1
MAC	Medium Access Control
MSC	Message Sequence Chart
NAS	Non Access Stratum
NBAP	Node B Application Protocol
PCH	Paging Channel
RAB	Radio Access Bearer
RACH	Random Access Channel
RANAP	Radio Access Network Application Part
RLC	Radio Link Control
RNC	Radio Network Controller
RNS	Radio Network Subsystem
RNSAP	Radio Network Subsystem Application Part
RRC	Radio Resource Control
SRNS	Serving RNS
UE	User Equipment
UMTS	Universal Mobile Telecommunication System
UTRAN	UMTS Terrestrial Radio Access Network

### 4.3 Notation for the signalling procedures

Complex signalling procedures may involve several protocols in different nodes.

In order to facilitate the understanding of these procedures, the following rules in the drawing of Message Sequence Chart (MSC) are applied:

- Messages are always exchanged between nodes, i.e. the sender and the receiver of a message are nodes and not single protocol entities;
- The protocol entity inside a node that is sending/receiving a message is represented by means of an ellipse, containing the protocol entity name;
- Each message is numbered, so that a numbered list with explanations can be added below the figure;
- Message parameters may be specified as shown in Figure 1 only when required for a clear understanding of the procedures;
- Explicit signalling is represented by means of continuous arrows.
- Inband signalling is represented by means of dotted arrows.
- A description of the relevant actions may be included as shown in Figure 1.
- The Setup and Release of Iub/Iur and Iu Data Transport Bearer with the ALCAP protocol is represented as shown in Figure 1.
- The transport channel used by the MAC protocol or the logical channel used by the RLC and RRC protocols may be indicated before the message name as shown in Figure 1.

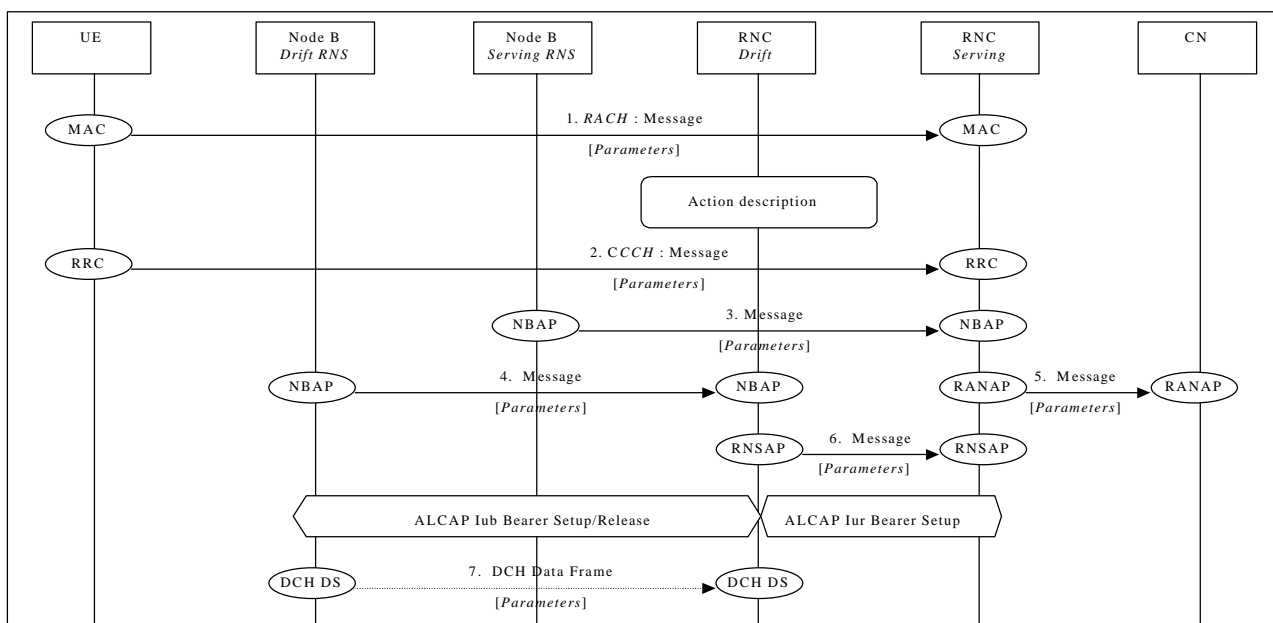
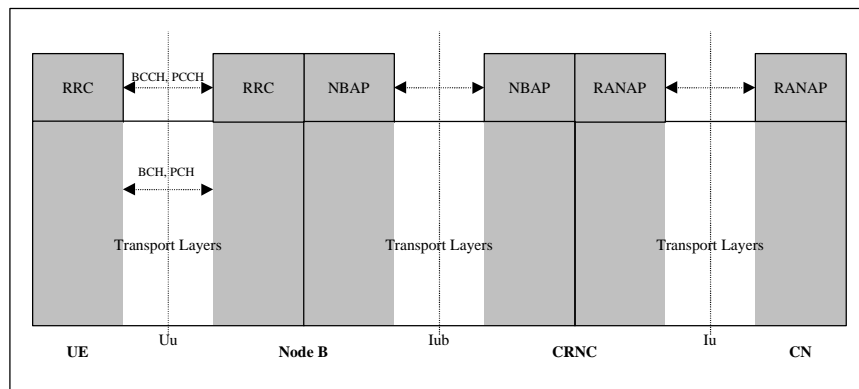

**Figure 1: Example of signalling procedure notation**

# UTRAN and UE protocol Architecture

## Protocol Architecture

The complete UTRAN and UE protocol architecture for the control plane (including the transport layers) is shown in Figure 2 (idle mode) and Figure 3 (connected mode). For a detailed description of the UTRAN Protocol Architecture and of the Radio Protocol Architecture refer to [5] and [10] respectively.



**Figure 2: UTRAN and UE control plane protocol architecture (idle mode)**

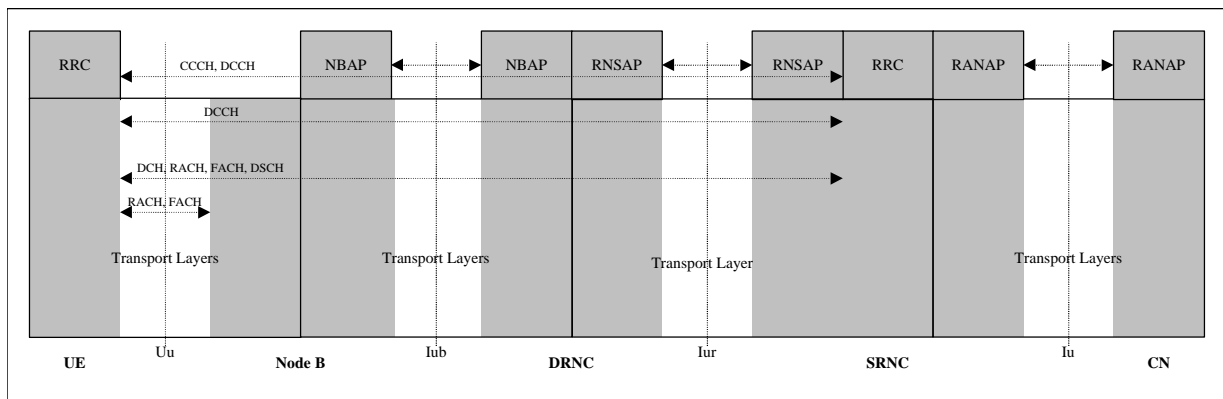

**Figure 3: UTRAN and UE control plane protocol architecture (connected mode)**

## RANAP Procedures & Messages

For a detailed description of RANAP procedures and messages refer to [6].

*Editor note: to be aligned with the protocol specification documents*

Message Name	UTRAN Procedure	Direction
Initial UE Message	NAS Signalling Connection Establish.	Source RNC ⇒ CN
RAB Assignment Request	RAB Establishment RAB Release Inter-RNS HO with switching in the CN	CN ⇒ Source RNC CN ⇒ Source RNC CN ⇒ Source RNC
RAB Assignment Complete	RAB Establishment RAB Release	Source RNC ⇒ CN Source RNC ⇒ CN
Relocation Required	Hard HO with switching in the CN UTRAN ⇒ GSM/BSS handover SRNS Relocation	Source RNC ⇒ CN Source RNC ⇒ CN Source RNC ⇒ CN
Relocation Request	Hard HO with switching in the CN UTRAN ⇒ GSM/BSS handover GSM/BSS handover ⇒ UTRAN SRNS Relocation	CN ⇒ Target RNC CN ⇒ Source RNC CN ⇒ Target RNC CN ⇒ Target RNC
Relocation Request Acknowledge	Hard HO with switching in the CN GSM/BSS handover ⇒ UTRAN SRNS Relocation	Target RNC ⇒ CN Target RNC ⇒ CN Target RNC ⇒ CN
Relocation Command	Hard HO with switching in the CN SRNS Relocation	CN ⇒ Source RNC CN ⇒ Source RNC
Relocation Detect	Hard HO with switching in the CN GSM/BSS handover ⇒ UTRAN	Target RNC ⇒ CN Target RNC ⇒ CN
Relocation Complete	Hard HO with switching in the CN GSM/BSS handover ⇒ UTRAN SRNS Relocation	Target RNC ⇒ CN Target RNC ⇒ CN Target RNC ⇒ CN
Relocation Failure	SRNS Relocation	RNC ⇒ CN
Iu Release Command	Hard HO with switching in the CN SRNS Relocation UTRAN ⇒ GSM/BSS handover	CN ⇒ Source RNC CN ⇒ Source RNC CN ⇒ Source RNC
Iu Release Complete	Hard HO with switching in the CN	Source RNC ⇒ CN

	SRNS Relocation UTRAN ⇒ GSM/BSS handover	Source RNC ⇒ CN Source RNC ⇒ CN
Paging	Paging	CN ⇒ SRNC

## RNSAP Procedures & Messages

For a detailed description of RNSAP procedures and messages refer to [7].

*Editor note: to be aligned with the protocol specification documents*

Message Name	UTRAN Procedure	Direction
Radio Link Reconfiguration Prepare	RAB Establishment RAB Release	SRNC ⇒ DRNC SRNC ⇒ DRNC
Radio Link Reconfiguration Ready	RAB Establishment RAB Release	DRNC ⇒ SRNC DRNC ⇒ SRNC
Radio Link Reconfiguration	RAB Establishment RAB Release	SRNC ⇒ DRNC SRNC ⇒ DRNC
Radio Link Reconfiguration Response	RAB Establishment RAB Release	DRNC ⇒ SRNC DRNC ⇒ SRNC
Radio Link Reconfiguration Commit	RAB Establishment RAB Release	SRNC ⇒ DRNC SRNC ⇒ DRNC
Radio Link Addition	Soft Handover	SRNC ⇒ DRNC
Radio Link Addition Response	Soft Handover	DRNC ⇒ SRNC
Radio Link Deletion	Soft Handover	SRNC ⇒ DRNC
Radio Link Deletion Response	Soft Handover	DRNC ⇒ SRNC
SRNS Relocation Commit	SRNS Relocation	Source RNC ⇒ Target RNC

## NBAP Procedures & Messages

For a detailed description of NBAP procedures and messages refer to [8].

*Editor note: to be aligned with the protocol specification documents*

Message Name	UTRAN Procedure	Direction
Radio Link Setup	RRC Connection Establishment	RNC ⇒ Node B



	Hard Handover	RNC ⇒ Node B
	Soft Handover	RNC ⇒ Node B
Radio Link Setup Respose	RRC Connection Establishment	Node B ⇒ RNC
	Hard Handover	Node B ⇒ RNC
	Soft Handover	Node B ⇒ RNC
Radio Link Addition	Soft Handover	RNC ⇒ Node B
Radio Link Addition Response	Soft Handover	RNC ⇒ Node B
Radio Link Deletion	RRC Connection Release	RNC ⇒ Node B
	Hard Handover	RNC ⇒ Node B
	Soft Handover	RNC ⇒ Node B
Radio Link Deletion Response	RRC Connection Release	Node B ⇒ RNC
	Hard Handover	Node B ⇒ RNC
	Soft Handover	Node B ⇒ RNC
Radio Link Reconfiguration Prepare	RAB Establishment	RNC ⇒ Node B
	RAB Release	RNC ⇒ Node B
Radio Link Reconfiguration Ready	RAB Establishment	Node B ⇒ RNC
	RAB Release	Node B ⇒ RNC
Radio Link Reconfiguration Commit	RAB Establishment	RNC ⇒ Node B
	RAB Release	RNC ⇒ Node B
Paging	Paging	RNC ⇒ Node B

## ALCAP

ALCAP is a generic name to indicate the protocol(s) used to establish data transport bearers on the Iu, Iur and Iub interfaces. Q.2630.1 (Q AAL2) is one of the selected protocol to be used as ALCAP.

The following should be noted:

- data transport bearers may be dynamically established using ALCAP or preconfigured;
- transport bearers may be established before or after allocation of radio resources.

### 4.1.1Q2630.1 (Q.AAL 2)

*Editor note: the exact procedures are needed to be derived from the reccomandation, therefore the following section should b intended as example. Contribution invited.*

The following figure is showing an example of use of Q2630.1 in the UTRAN context, for the different interfaces

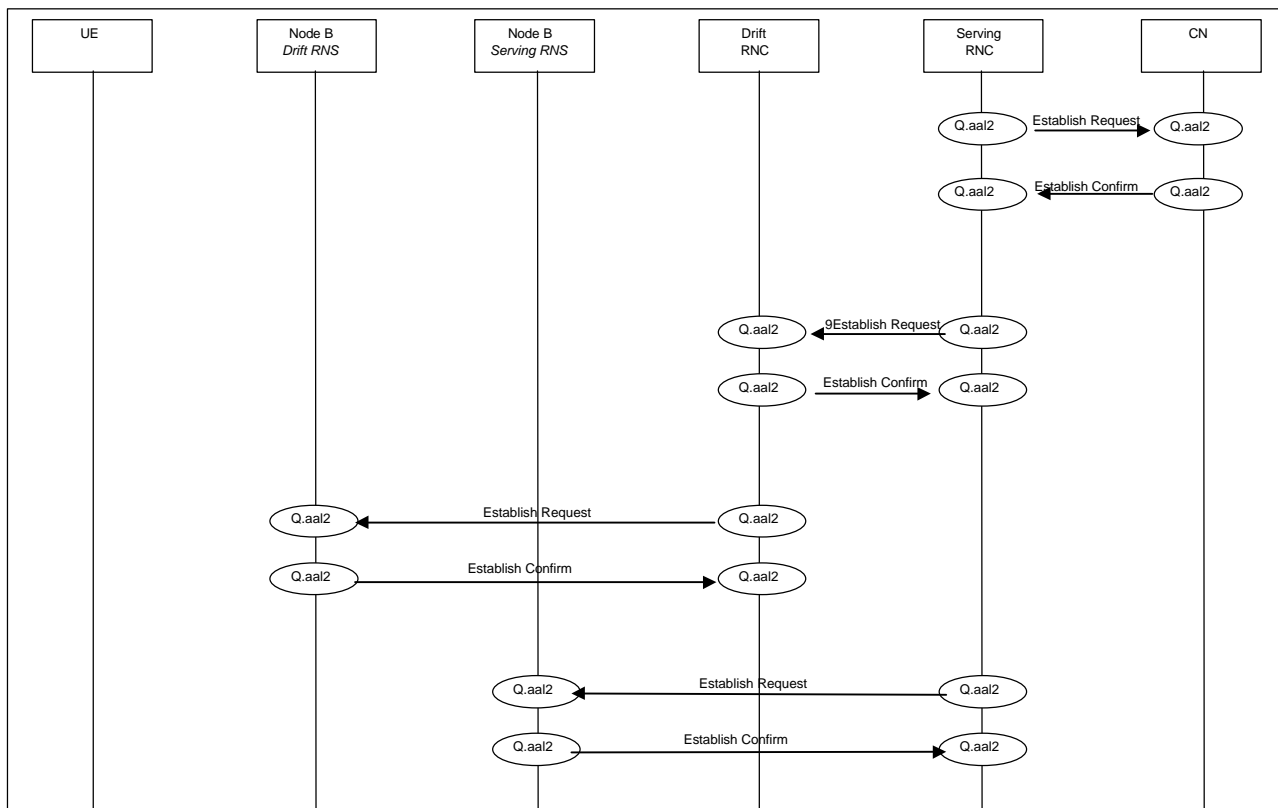

## RRC Procedures & Messages

For a detailed description of RRC procedures and messages refer to [14].

*Editor note: to be aligned with the protocol specification documents*

Message Name	UTRAN Procedure	Direction	Logical Channel
UE Capability Information	NAS Signalling Conn. Est.	UE ⇒ SRNC	DCCH
Direct Transfer	NAS Signalling Conn. Est.	UE ⇔ SRNC	DCCH
RRC Connection Request	RRC Connection Est.	UE ⇒ SRNC	CCCH
RRC Connection Setup	RRC Connection Est.	SRNC ⇒ UE	CCCH
RAB Setup	RAB Establishment	SRNC ⇒ UE	DCCH
RAB Setup Complete	RAB Establishment	UE ⇒ SRNC	DCCH
RAB Release	RAB Release	SRNC ⇒ UE	DCCH
RAB Release Complete	RAB Release	UE ⇒ SRNC	DCCH
Handover Command			DCCH

	Hard Handover	SRNC $\Rightarrow$ UE	
Handover Complete	Hard Handover	UE $\Rightarrow$ SRNC	DCCH
Active Set Update	Soft Handover	SRNC $\Rightarrow$ UE	DCCH
Active Set Update Complete	Soft Handover	UE $\Rightarrow$ SRNC	DCCH
Paging	Paging for a UE in RRC Connected Mode	SRNC $\Rightarrow$ UE	DCCH

---

## UTRAN Signaling Procedures

The signalling procedures shown in the following sections do not represent the complete set of possibilities, nor do they mandate this kind of operation. The standard will specify a set of elementary procedures for each interface, which may be combined in different ways in an implementation. Therefore these sequences are merely examples of a typical implementation.

Furthermore the list of parameters may not be complete, but should only be seen as examples of possible information carried by the messages.

NOTE: the use of Radio Bearer Setup or Radio Bearer Assignment is FFS. This note is valid for all the document

---

## Procedures not related to a specific UE (global procedures)

This section presents a number of signaling procedures not related to a specific UE. The protocol stack involved during these procedures is the one shown in Figure 2.

### System Information Broadcasting

This example shows an example of System Information broadcasting.

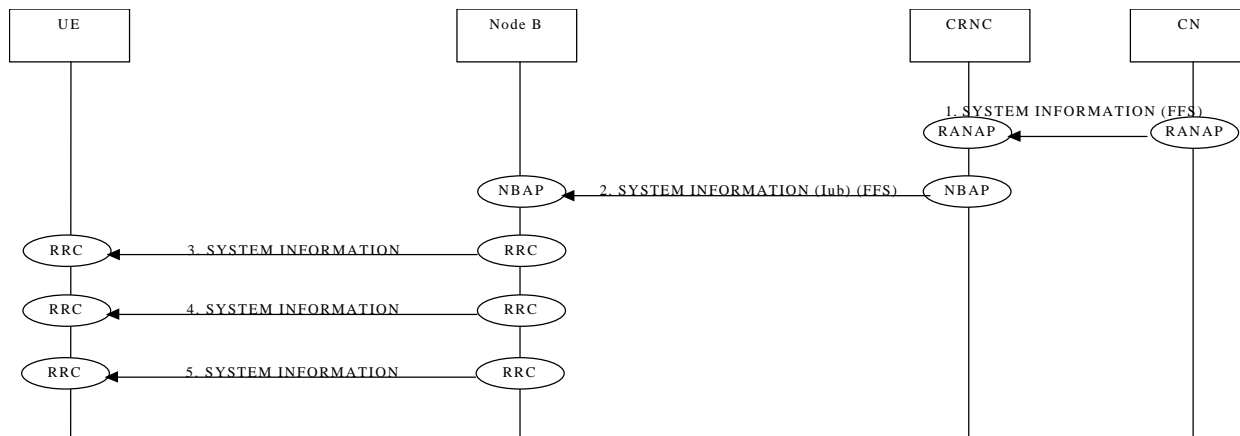

**System Information Broadcasting**

### Cell Broadcast

This example shows an example of broadcasting of User Information.

---

## Procedures related to a specific UE

This section presents a number of signaling procedures related to a specific UE. The protocol stack involved during these procedures is the one shown in Figure 3, with the exception of Paging for a UE in RRC Idle Mode that makes use of the protocol stack shown in Figure 2.

## Paging

This section presents two examples of Paging procedures for both the cases of a UE in RRC Idle Mode and RRC Connected Mode.

### 4.1.1 Paging for a UE in RRC Idle Mode

This example shows how paging is performed for a UE in RRC Idle Mode. The UE may be paged for a CS or PS service. Since the UE is in RRC Idle Mode, the location is only known at CN level and therefore paging is distributed over a defined geographical area (e.g. LA).

Note: Example below illustrates scenario where LA spans across 2 RNCs.

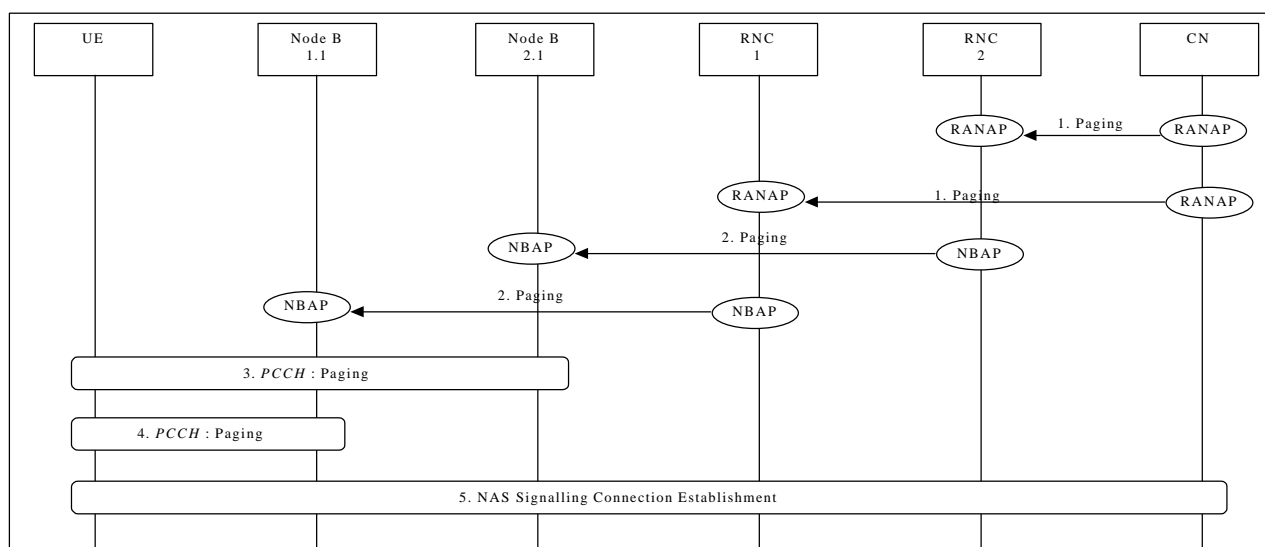

#### Paging for a UE in RRC Idle Mode

1. CN initiates the paging of a UE over a LA spanning two RNCs (i.e. RNC1 and RNC2) via RANAP message **Paging**.

Parameters: UE identifier, Paging Type.

2. RNC1 and RNC2 forward **Paging** message via NBAP to corresponding Nodes B (for example Node B 1.1, Node B 2.1).

Parameters: UE identifier.

3. Paging of UE performed by cell1
4. Paging of UE performed by cell2
5. UE detects page message from RNC1 and the procedure for NAS signalling connection establishment is followed

NAS message transfer over established signalling connection can now be performed.

### 4.1.2 Paging for a UE in RRC Connected Mode

This can occur in case of two core network domains, with the mobility management independent of each other. Two possible solutions exists:

- The UTRAN coordinates the paging request with the existing RRC connection.
- The UE coordinates the paging request with the existing RRC connection.

The following example shows how paging is performed for a UE in RRC Connected Mode when the UTRAN coordinates the paging request with the existing RRC connection using DCCH.

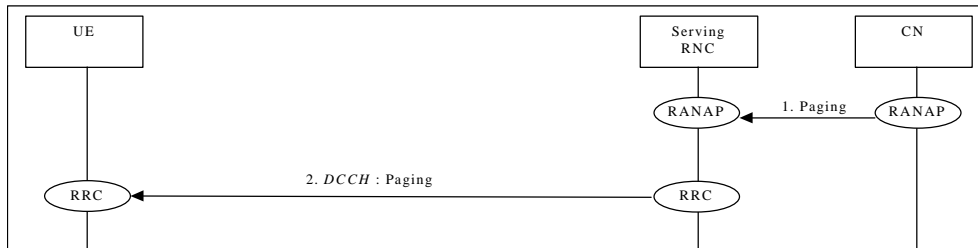

### Paging for a UE in RRC Connected Mode when the UTRAN coordinates the paging request with the existing RRC connection using DCCH

1. CN initiates the paging of a UE via RANAP message **Paging**.

Parameters: UE identifier, Paging Type.

2. SRNC sends RRC message **Paging**.

Parameters: Paging Type.

## NAS Signalling Connection Establishment

The following examples show establishment of a Signalling Connection either by the UE or by the CN.

### 4.4.4 UE Initiated Signalling Connection Establishment

This example shows establishment of a UE originated NAS Signalling Connection Establishment.

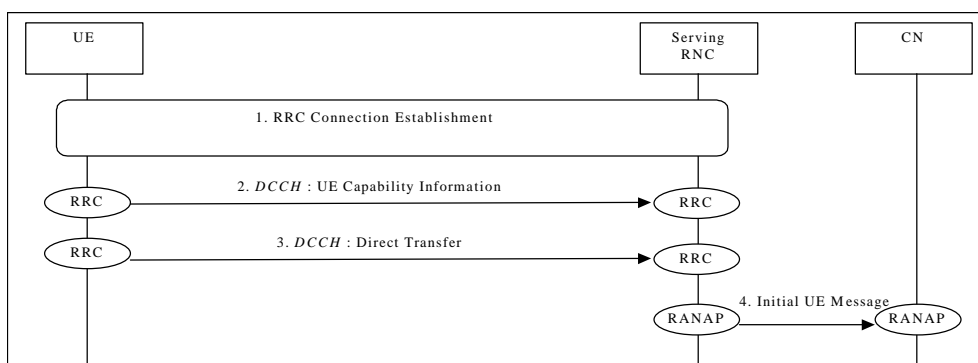

### NAS Signalling Connection Establishment

1. RRC Connection is established (see 9.3.1 or 9.3.2).
2. UE sends RRC message **UE Capability Information** to SRNC.  
Parameters: UE Radio Capability (e.g. maximum number of simultaneous radio links, maximum TX power capability, supported radio access types).

Note: To speed up the transfer of the initial NAS message the RRC message **UE Capability Information** could be transferred after the initial NAS message (step 3). This issue is FFS.

3. UE sends RRC **Direct Transfer** to SRNC.  
Parameters: Initial NAS Message (could for a GSM based CN be e.g. CM Service Request, Location Update Request etc.) CN node indicator (it indicates the correct CN node into which the NAS message shall be forwarded).
4. SRNC initiates signalling connection to CN, and sends the RANAP message **Initial UE Message**.  
Parameters: Initial NAS Message (could for a GSM based CN be e.g. CM Service Request, Location Update Request etc.).

The NAS signalling connection between UE and CN can now be used for NAS message transfer.

## CN Initiated Signalling Connection Establishment

This example shows establishment of a CN originated NAS Signalling Connection Establishment.

## RRC Connection Establishment

The following examples show establishment of a RRC connection either on a dedicated channel (DCH) or on a common transport channel

### 4.1.1 DCH Establishment

This example shows establishment of an RRC connection on a dedicated channel (DCH).

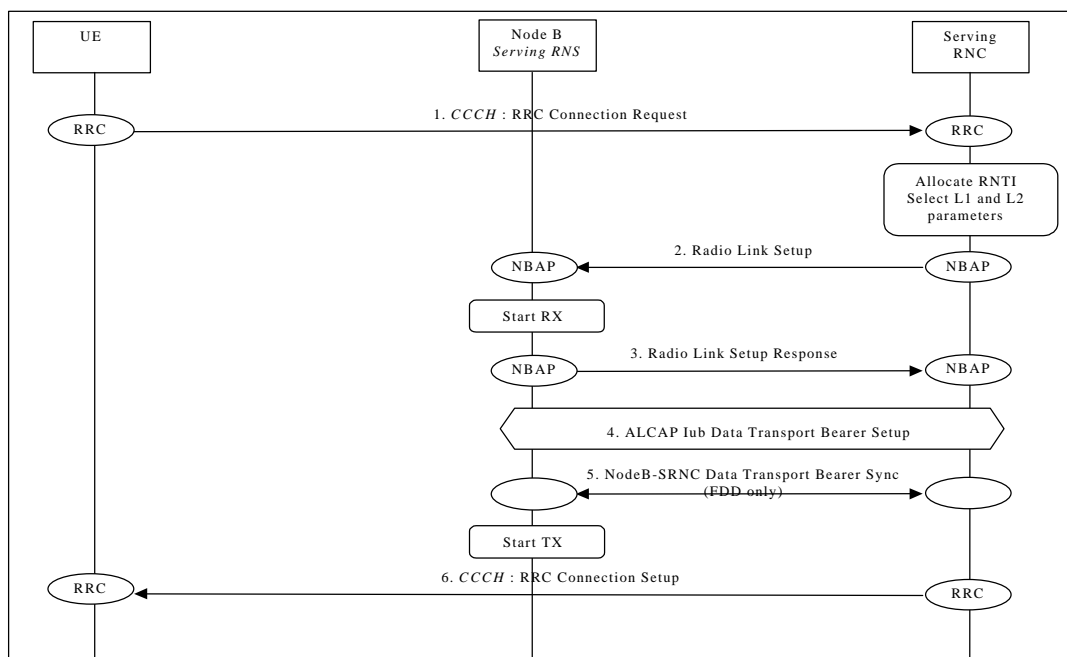

### RRC Connection Establishment - DCH Establishment

1. The UE initiates set-up of an RRC connection by sending RRC message **Connection Request** on CCCH.  
Parameters: UE identification, reason for RRC connection.  
Note: Type of UE identification and Layer 1 Node B Acknowledge on RACH (CCCH) are FFS.
2. The SRNC decides to use a DCH for this RRC connection, allocates RNTI and radio resources for the RRC connection. When a DCH is to be set-up, NBAP message **Radio Link Setup** is sent to Node B.  
Parameters: Cell id, Transport Format Set, Transport Format Combination Set, frequency, UL scrambling code(FDD only), Time Slots (TDD only), User Codes (TDD only),DL channelisation code, Power control information.

3. Node B allocates resources, starts PHY reception, and responds with NBAP message **Radio Link Setup Response**.  
Parameters: Signalling link termination, , DL channelisation code (FDD only), Transport layer addressing information (AAL2 address, AAL2 Binding Identity) for the Iub Data Transport Bearer.
4. SRNC initiates set-up of Iub Data Transport bearer using ALCAP protocol. This request contains the AAL2 Binding Identity to bind the Iub Data Transport Bearer to the DCH. The request for set-up of Iub Data Transport bearer is acknowledged by Node B.
5. Node B and SRNC establish synchronism for the Iub Data Transport Bearer. Then Node B starts DL transmission. (FDD only)
6. Message **RRC Connection Setup** is sent on CCCH from SRNC to UE.  
Parameters: UE identification, RNTI, Transport Format Set, Transport Format Combination Set, frequency, DL scrambling code (FDD only), Time Slots (TDD only), User Codes (TDD only), DL channelisation code(FDD only), Power control information.

## 4.1.2 RACH/FACH Establishment

The procedure for establishment of an RRC connection on a common transport channel (RACH/FACH) is described in [Editor note: appropriate reference to the WG2 documentation is needed]. A prerequisite for this example is that the necessary Iub Data Transport bearer for the RACH/FACH is established prior to this procedure.

## RRC Connection Release

The following examples show RRC connection release either of a dedicated channel (DCH) or of a common transport channel (RACH/FACH).

### 4.1.4 DCH Release

This example shows RRC Connection release of a dedicated channel.

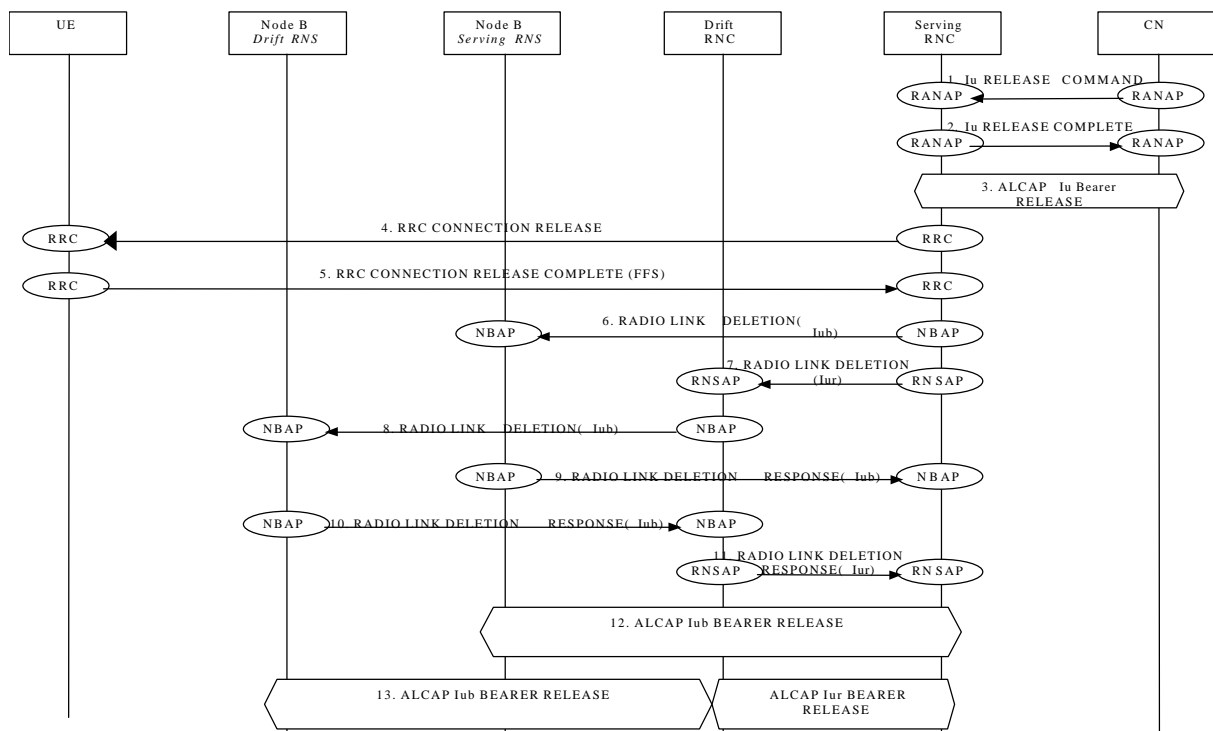



## RRC Connection release of a dedicated channel

### 4.1.2 Common Transport Channel Release

This example shows RRC Connection release of a common transport channel.

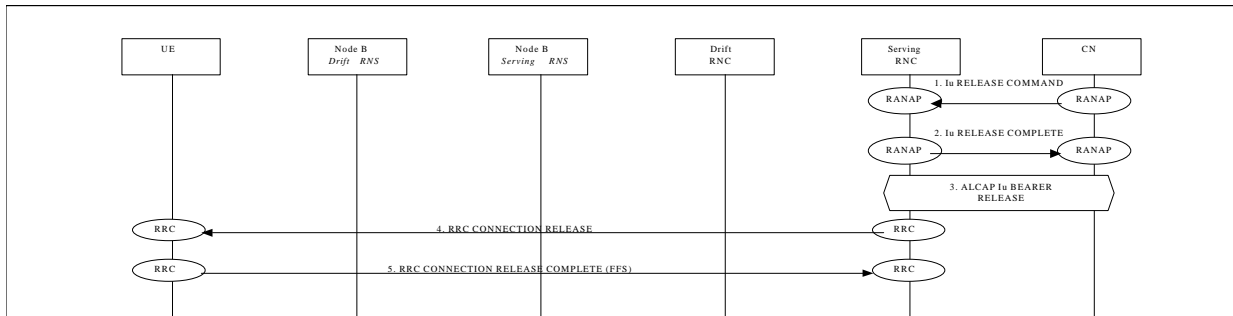

## RRC Connection release of a common transport channel

## RRC Connection Re-establishment

The following examples show re-establishment of a RRC connection either on a dedicated channel (DCH) or on a common transport channel.

### 4.1.4 DCH Re-establishment

#### RRC connection Re-establishment (Anchor approach) – DCH Re-establishment

This example shows re-establishment of a RRC connection on a dedicated channel (DCH).

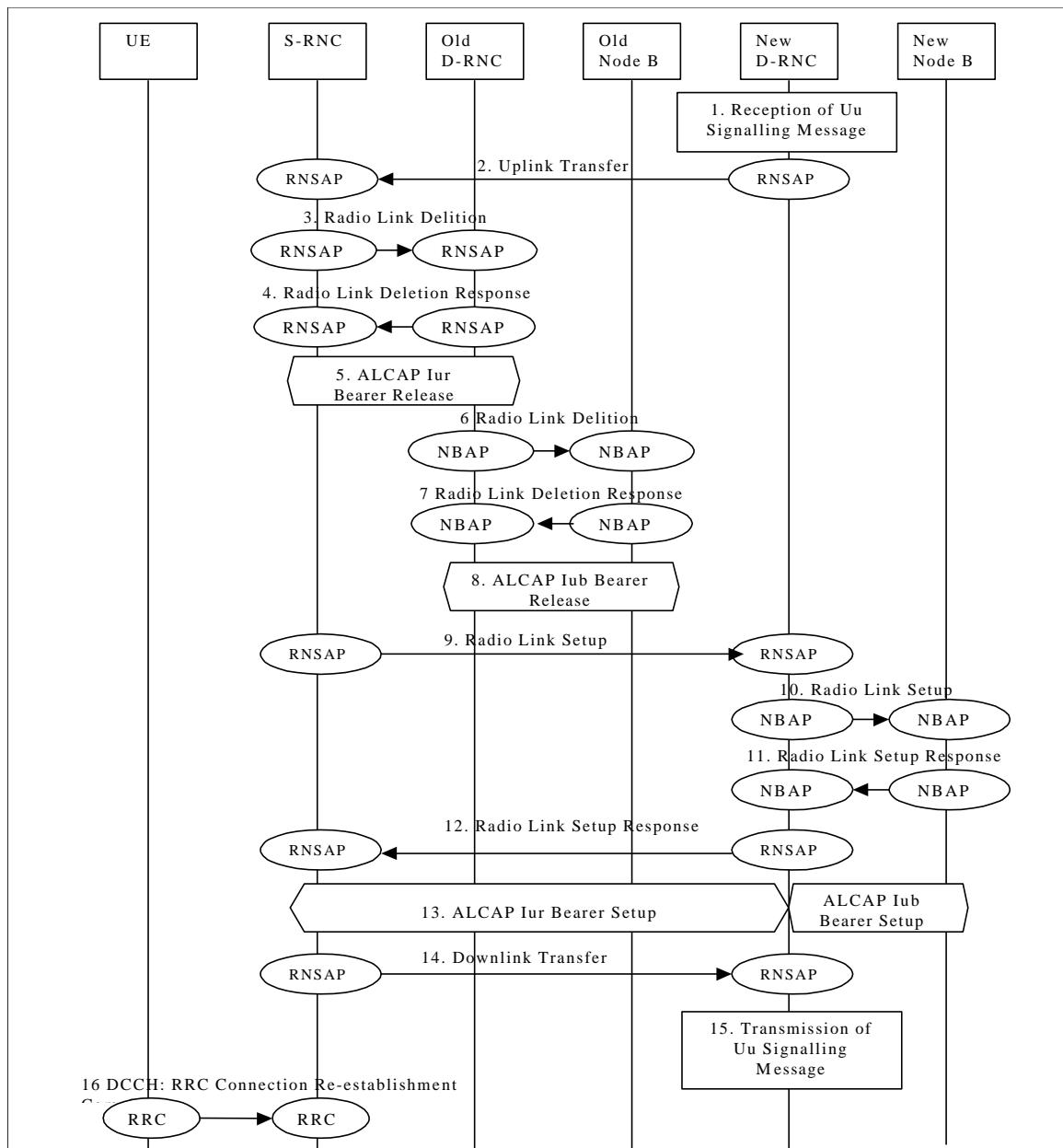

### RRC connection Re-establishment (Anchor approach) – DCH Re-establishment

1. The UE initiates the re-establishment of the RRC connection with the new cell by sending **RRC Connection Re-establishment Request** message on CCCH.
2. The new RNC delivers this message transparently as **Uplink Transfer** message to the serving RNC.
- 3./4./5./6./7./8. The SRNC initiates release of Iur/Iub Data Transport bearer using ALCAP protocol and also release of Iur/Iub Radio resource using RNSAP / NBAP protocols.
9. The serving RNC allocates new RNTI and radio resources for the RRC connection on Iur, and sends the RNSAP message **Radio Link Setup** to the target RNC.
10. The target RNC sends the NBAP message **Radio Link Setup** to the target Node B.
11. Node B allocates resources, and responds with NBAP message **Radio Link Setup Response**.
12. Target RNC responds with RNSAP message **Radio Link Setup Response**.

13. Serving RNC initiates set-up of Iur / Iub Data Transport bearer using ALCAP protocol. This request contains the AAL2 Binding Identity to bind the Iur / Iub Data Transport Bearer to the DCH. The request for set-up of Iur / Iub Data Transport bearer is acknowledged by target RNC / Node B.
14. The serving RNC sends the transparent RNSAP message **Downlink transfer** to the new CRNC.
15. The New CRNC delivers this message as **RRC Connection Re-establishment** message on CCCH.
16. Message **RRC Connection Re-establishment Complete** is sent on the new DCCH from the UE to the serving RNC.

### RRC Connection Re-establishment with SRNC Relocation - DCH Re-establishment

This section shows an example for the RRC Connection Re-establishment procedure, in case of DCH Re-establishment.

It is assumed that a signalling link is available on the Iur, but no DCH is established on this interface.

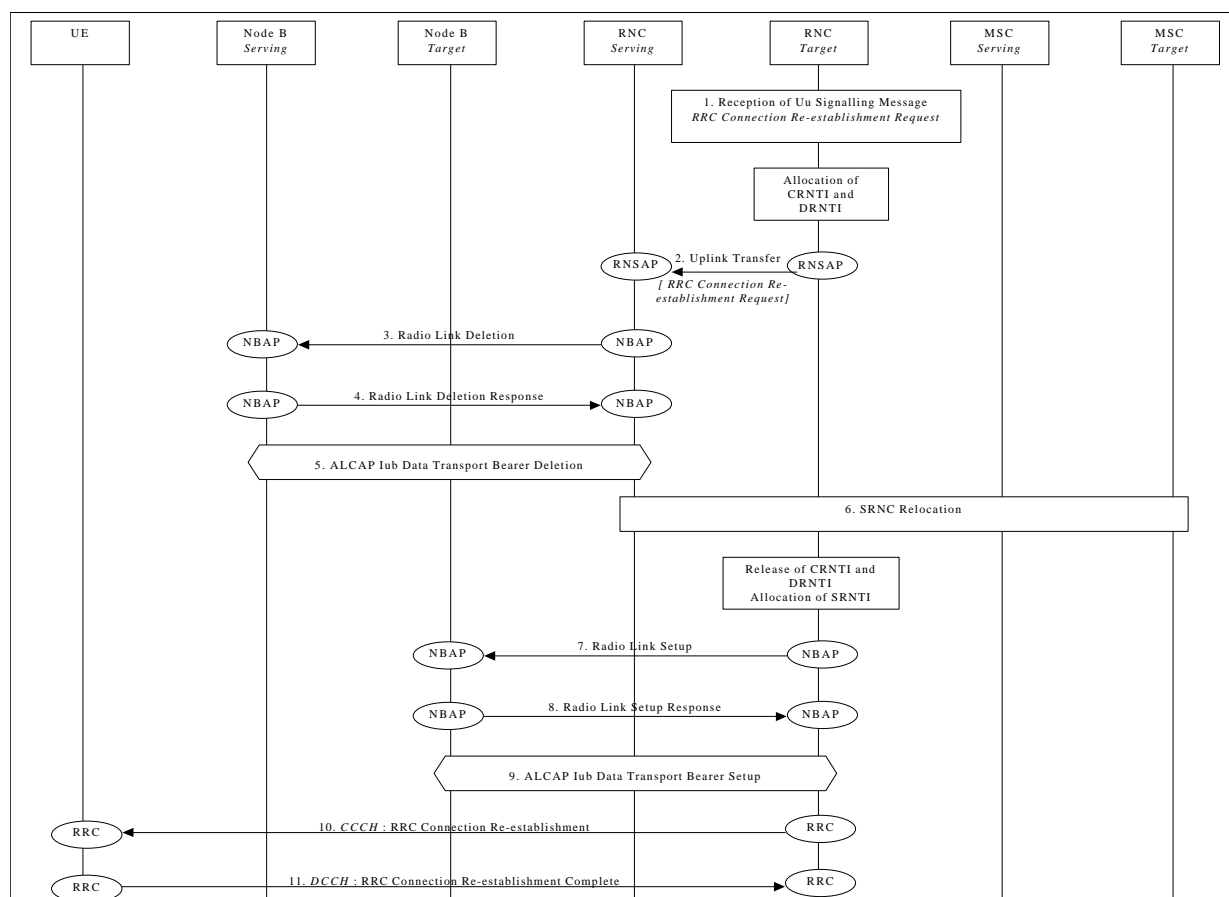

### RRC Connection Re-establishment with SRNC Relocation - DCH Re-establishment

1. The UE initiates the re-establishment of the RRC connection with the new cell by sending **RRC Connection Re-establishment Request** message on CCCH. The message is received by the Target RNC.
2. The target RNC delivers the received message transparently as **Uplink Transfer** message to the serving RNC.

3. The Serving RNC sends NBAP message **Radio Link Deletion** to Node B.  
Parameters: Cell id, Transport layer addressing information.
4. Node B deallocates radio resources. Successful outcome is reported in NBAP message **Radio Link Deletion Response**.
5. The SRNC initiates release of Iub Data Transport bearer using ALCAP protocol.
6. SRNC relocation procedure is triggered by the reception of the message **RRC Connection Re-establishment Request** embeded in the RNSAP **Uplink Transfer** message (relocation is performed in parallel with Radio Link release).
7. The target RNC (new SRNC) allocates RNTI and radio resources for the RRC connection, and sends the NBAP message **Radio Link Setup** to the target Node B.  
Parameters: Cell id, Transport Format Set, Transport Format Combination Set, frequency, UL scrambling code (FDD only), Time Slots (TDD only), User Codes (TDD only),DL channelisation code (FDD only), Power control information.
8. Target Node B allocates resources, starts PHY reception, and responses with NBAP message **Radio Link Setup Response**.  
Parameters: Signalling link termination, Transport layer addressing information for the Iub Data Transport Bearer.
9. Target RNC (new SRNC) initiates set-up of Iub Data Transport bearer using ALCAP protocol. This request contains the AAL2 Binding Identity to bind the Iub Data Transport Bearer to the DCH. The request for set-up of Iub Data Transport bearer is acknowledged by Node B.
10. Message **RRC Connection Re-establishment** is sent on CCCH from target RNC (new SRNC) to UE.  
Parameters: Old RNTI, New RNTI, Transport Format Set, Transport Format Combination Set, frequency, DL scrambling code (FDD only), Time Slots (TDD only), User Codes (TDD only), DL channelisation code (FDD only).
11. Message **RRC Connection Re-establishment Complete** is sent on the new DCCH from the UE to the Target RNC (new SRNC).

Note: SRNC Relocation execution is performed asynchronously respect to thr RL delition procedure (step 3/4).

## 4.4.2 RACH/FACH Re-establishment

This example shows re-establishment of a RRC connection on a common transport channel .

## Radio Access Bearer Establishment

The following examples show establishment of a radio access bearer on a dedicated channel (DCH) or on a common transport channel (RACH/FACH) when the RRC connection already support a radio access bearer either on a dedicated channel (DCH) or on a common transport channel (RACH/FACH).

### 4.4.4 DCH - DCH Establishment - Synchronized

This example shows establishment of a radio access bearer on a dedicated channel (DCH) when the RRC connection already uses a dedicated channel (DCH).

[FDD-The UE communicates via two Nodes B. One Node B is controlled by SRNC, one Node B is controlled by DRNC]

[TDD – The Nodes B shown in the figure are mutually exclusive in TDD mode.]

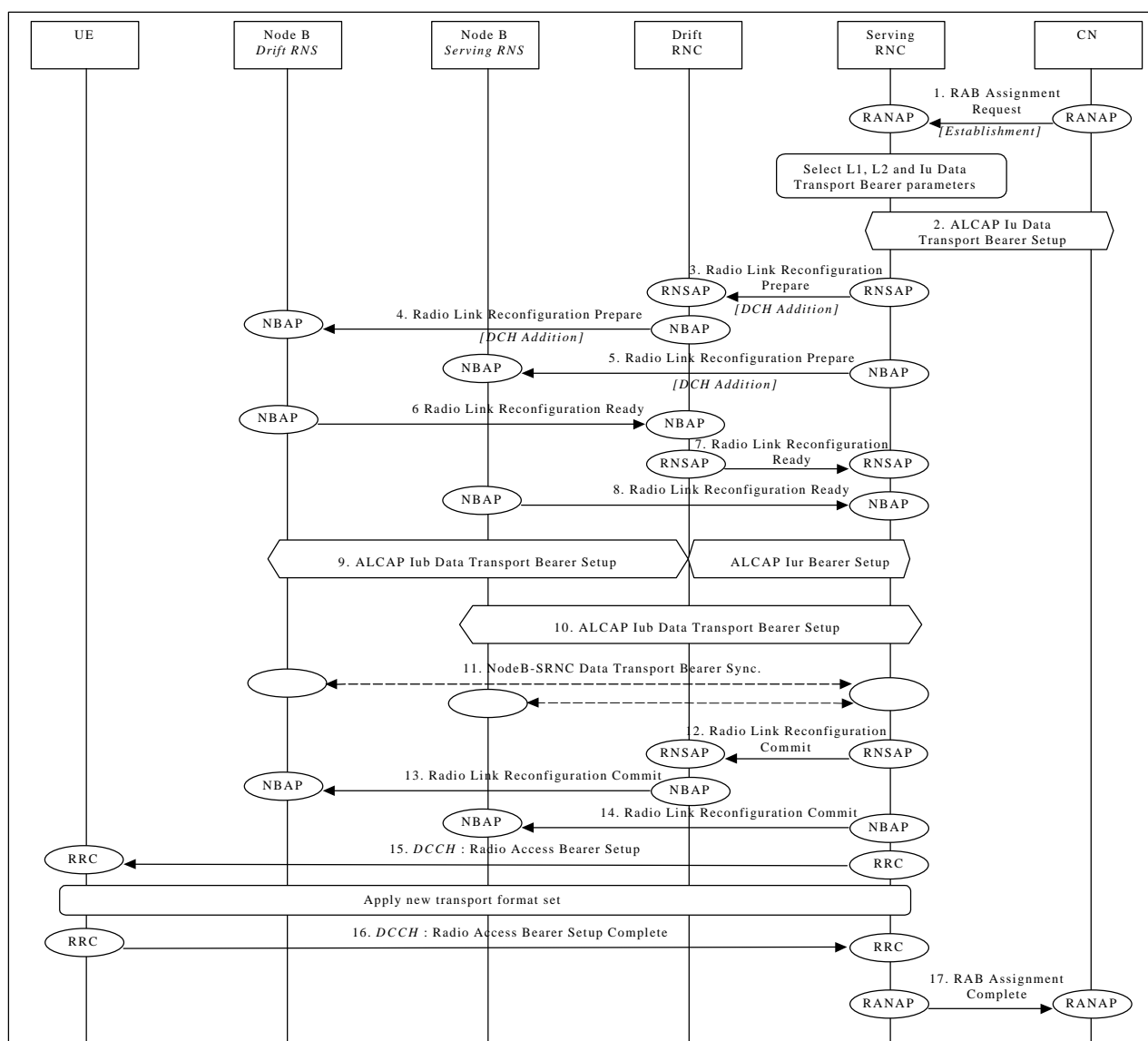

### Radio Access Bearer Establishment - DCH - DCH Establishment - Synchronized

1. CN initiates establishment of the radio access bearer with RANAP message **RAB Assignment Request**.  
Parameters: RAB QoS parameters, Transport layer addressing information (AAL2 address, AAL2 Binding Identity) for Iu Data Transport Bearer SRNC decides the requirements on L1, L2 and Iu Data Transport Bearer.
2. SRNC initiates set-up of Iu Data Transport bearer using ALCAP protocol. This request contains the AAL2 Binding Identity to bind the Iu Data Transport Bearer to the Radio Access Bearer.
3. SRNC requests DRNC to prepare establishment of DCH to carry the RAB (**Radio Link Reconfiguration Prepare**).  
Parameters: Transport Format Set, Transport Format Combination Set, Power control information, instructions for DCH mapping on Iub Data Transport Bearers.  
This step is applicable only when more Nodes B are involved.
4. DRNC requests its Node B to prepare establishment of DCH to carry the RAB (**Radio Link Reconfiguration Prepare**).  
Parameters: Transport Format Set, Transport Format Combination Set, Power control information, , DL channelisation code.  
This step is applicable only when more Nodes B are involved.

5. SRNC requests its Node B to prepare establishment of DCH to carry the RAB (**Radio Link Reconfiguration Prepare**).  
Parameters: Transport Format Set, Transport Format Combination Set, Power control information, Time Slots (TDD only), User Codes (TDD only).
6. Node B allocates resources and notifies DRNC that the preparation is ready (**Radio Link Reconfiguration Ready**).  
Parameters: Transport layer addressing information (AAL2 address, AAL2 Binding Id) for Iub Data Transport Bearer.  
This step is applicable only when more Nodes B are involved.
7. DRNC notifies SRNC that the preparation is ready (**Radio Link Reconfiguration Ready**).  
Parameters: Transport layer addressing information (AAL2 address, AAL2 Binding Id) for Iub Data Transport Bearer.  
This step is applicable only when more Nodes B are involved.
8. Node B allocates resources and notifies SRNC that the preparation is ready (**Radio Link Reconfiguration Ready**).  
Parameters: DL channelisation code Per Cell (FDD only), Transport layer addressing information (AAL2 address, AAL2 Binding Id) for Iub Data Transport Bearer.
9. SRNC initiates setup of Iur/Iub Data Transport Bearer using ALCAP protocol. This request contains the AAL2 Binding Identity to bind the Iur/Iub Data Transport Bearer to DCH.  
This step is applicable only when more Nodes B are involved.
10. SRNC initiates setup of Iub Data Transport Bearer using ALCAP protocol. This request contains the AAL2 Binding Identity to bind the Iub Data Transport Bearer to DCH.
11. The Nodes B and SRNC establish synchronism for the Iub and Iur Data Transport Bearer.  
This step is applicable only for the FDD case..
12. RNSAP message **Radio Link Reconfiguration Commit** is sent from SRNC to DRNC.  
Parameters:  
This step is applicable only when more Nodes B are involved.
13. NBAP message **Radio Link Reconfiguration Commit** is sent from DRNC to Node B.  
Parameters:  
This step is applicable only when more Nodes B are involved.
14. NBAP message **Radio Link Reconfiguration Commit** is sent from SRNC to Node B.  
Parameters:
15. RRC message **Radio Access Bearer Setup** is sent by SRNC to UE.  
Parameters: Transport Format Set, Transport Format Combination Set, DL channelisation code per cell (FDD only), Time Slots (TDD only), User Codes (TDD only).
16. UE sends RRC message **Radio Access Bearer Setup Complete** to SRNC.
17. SRNC sends RANAP message **RAB Assignment Complete** to CN.

## DCH - DCH Establishment - Unsynchronized (PSTN/ISDN Core Network)

This example shows an establishment of a radio access bearer on a dedicated channel (DCH) when the RRC connection already uses a dedicated channel (DCH). The UE communicates via two Nodes B. One Node B is controlled by SRNC, one Node B is controlled by DRNC. The reconfiguration time does not require to be synchronised among Node-Bs, SRNC and UE.

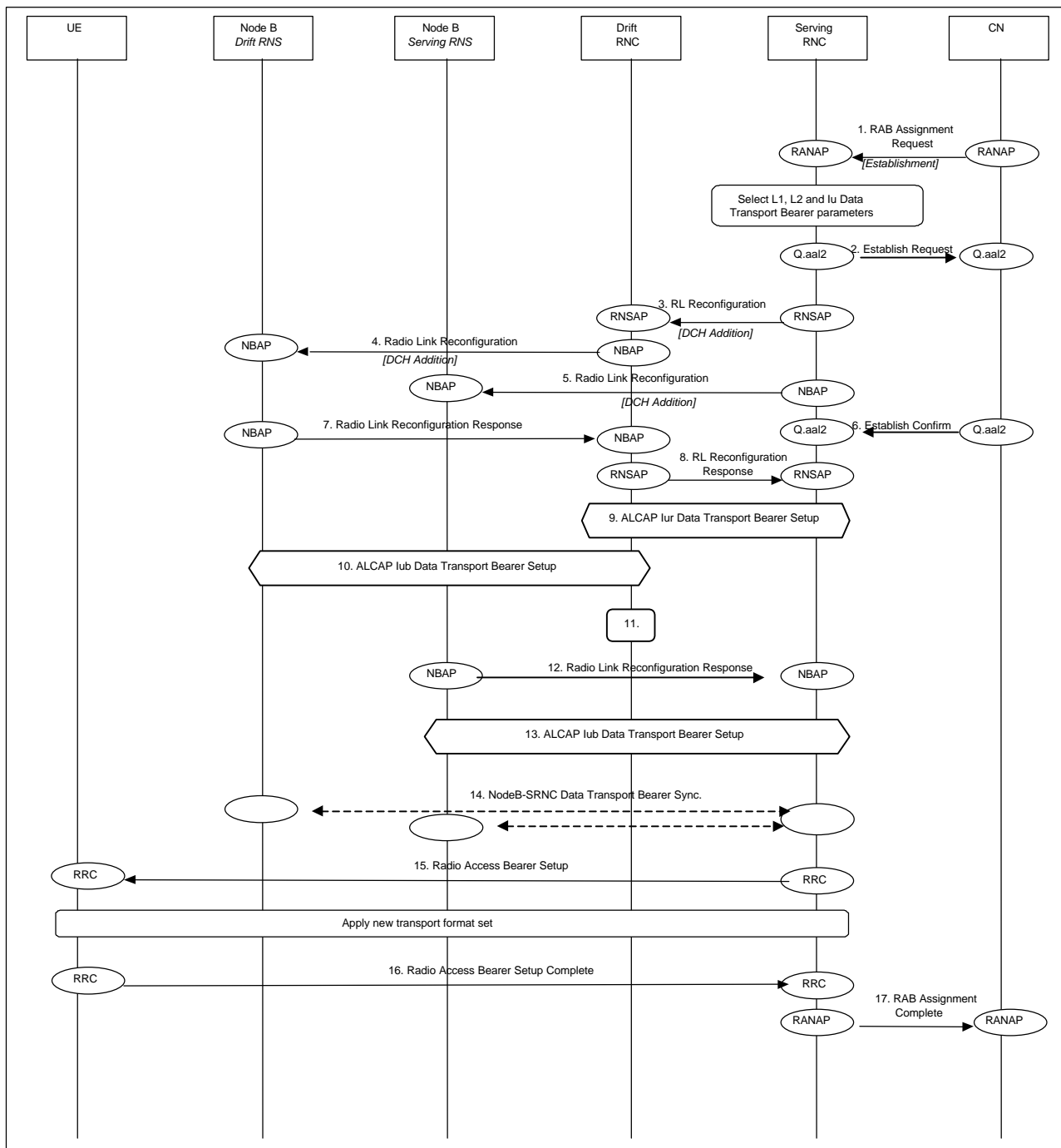

### Radio Access Bearer Establishment - DCH - DCH Establishment – Unsynchronised

1. CN initiates establishment of the radio access bearer with RANAP Radio Access Bearer Assignment Request message.  
Parameters: RAB QoS parameters, AAL2 binding Identity
2. SRNC performs mapping of the RAB QoS parameters to AAL2 link characteristics and initiates set-up of Iu Data Transport bearer with Q.aal2 Establish Request message.  
Parameters: Served User Generated Reference, AAL2 link characteristics ...
3. SRNC decided that there are no need for a synchronous RL reconfiguration, and requests DRNC to setup a new DCH. It include in the message that the modification shall be done immediately without waiting for the command message.

Parameters: Bearer ID, Mode= Unsynchronised, Transport Format Set, Transport Format Combination Set, Power control information

4. DRNC requests its Node B to establish of a new DCH in the existing Radio Link.  
Parameters: Bearer ID, Mode= Unsynchronised, Transport Format Set, Transport Format Combination Set, Power control information.
5. SRNC requests its Node B setup a new DCH in the existing Radio Link.  
Parameters: Bearer ID, Mode= Unsynchronised, Transport Format Set, Transport Format Combination Set, Power control information
6. CN confirms the establishment of the transport bearer and binds it to the radio network layer.
7. Node B allocates resources and notifies DRNC that the setup is done.  
Parameters: Transport layer addressing information (AAL2 address, AAL2 Binding Id) for Iub Data Transport Bearer.
8. DRNC notifies SRNC that the setup is done.  
Parameters: Transport layer addressing information (AAL2 address, AAL2 Binding Id) for Iub Data Transport Bearer.
9. SRNC initiates setup of Iur Data Transport Bearer using ALCAP protocol. This request contains the AAL2 Binding Identity to bind the Iur Data Transport Bearer to DCH.
10. SRNC initiates setup of Iub Data Transport Bearer using ALCAP protocol. This request contains the AAL2 Binding Identity to bind the Iub Data Transport Bearer to DCH.
11. DRNC performs bridging of Iub and Iur Data Transport bearers.
12. Node B allocates resources and notifies SRNC that the setup is done.  
Parameters: Transport layer addressing information (AAL2 address, AAL2 Binding Id) for Iub Data Transport Bearer.
13. SRNC initiates setup of Iub Data Transport Bearer using ALCAP protocol. This request contains the AAL2 Binding Identity to bind the Iub Data Transport Bearer to DCH.
14. The Nodes B and SRNC establish frame synchronism for the Iub and Iur Data Transport Bearer.
15. RRC message Radio Access Bearer Setup is sent by SRNC to UE.  
Parameters: Transport Format Set, Transport Format Combination Set.
16. UE sends RRC message Radio Access Bearer Setup Complete to SRNC.
17. SRNC sends RANAP message Radio Access Bearer Assignment Complete to CN.  
Parameters: Binding ID

### 4.1.3 RACH/FACH - DCH Establishment

This example shows establishment of a radio access bearer on a dedicated channel (DCH) when the RRC connection already uses a common transport channel RACH/FACH).



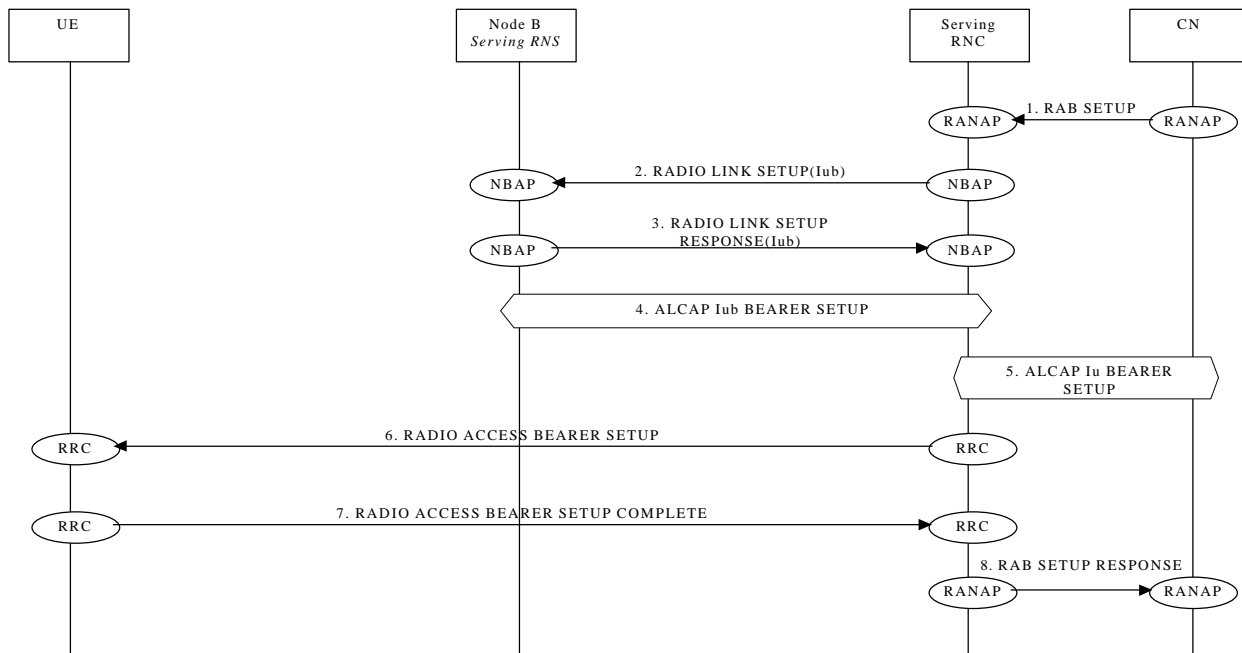

### 4.1.4 RACH/FACH - RACH/FACH Establishment

This example shows establishment of a radio access bearer on a common transport channel (RACH/FACH) when the RRC connection already uses a common transport channel (RACH/FACH).

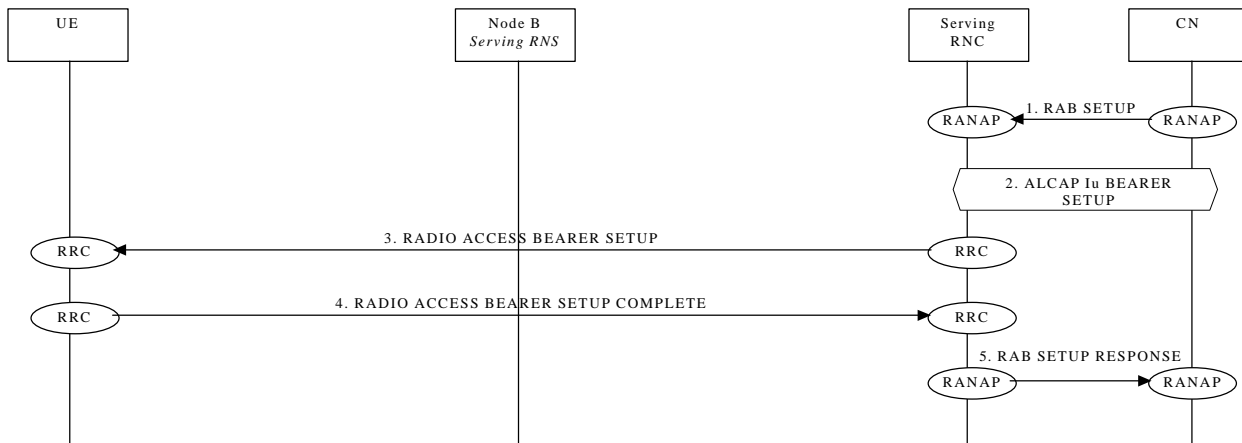

## Radio Access Bearer Release

The following examples show release of a radio access bearer either on a dedicated channel (DCH) or on a common transport channel (RACH/FACH) when the RRC connection already uses a dedicated channel (DCH) or a common transport channel (RACH/FACH).

### 4.1.4 DCH - DCH Release - Synchronized

This example shows release of a radio access bearer on a dedicated channel (DCH) when the RRC connection still uses a dedicated channel (DCH) after the release.

[FDD - The UE communicates via two Nodes B. One Node B is controlled by SRNC, one Node B is controlled by DRNC.]

[TDD – The Nodes B shown in the figure are mutually exclusive in TDD mode.]

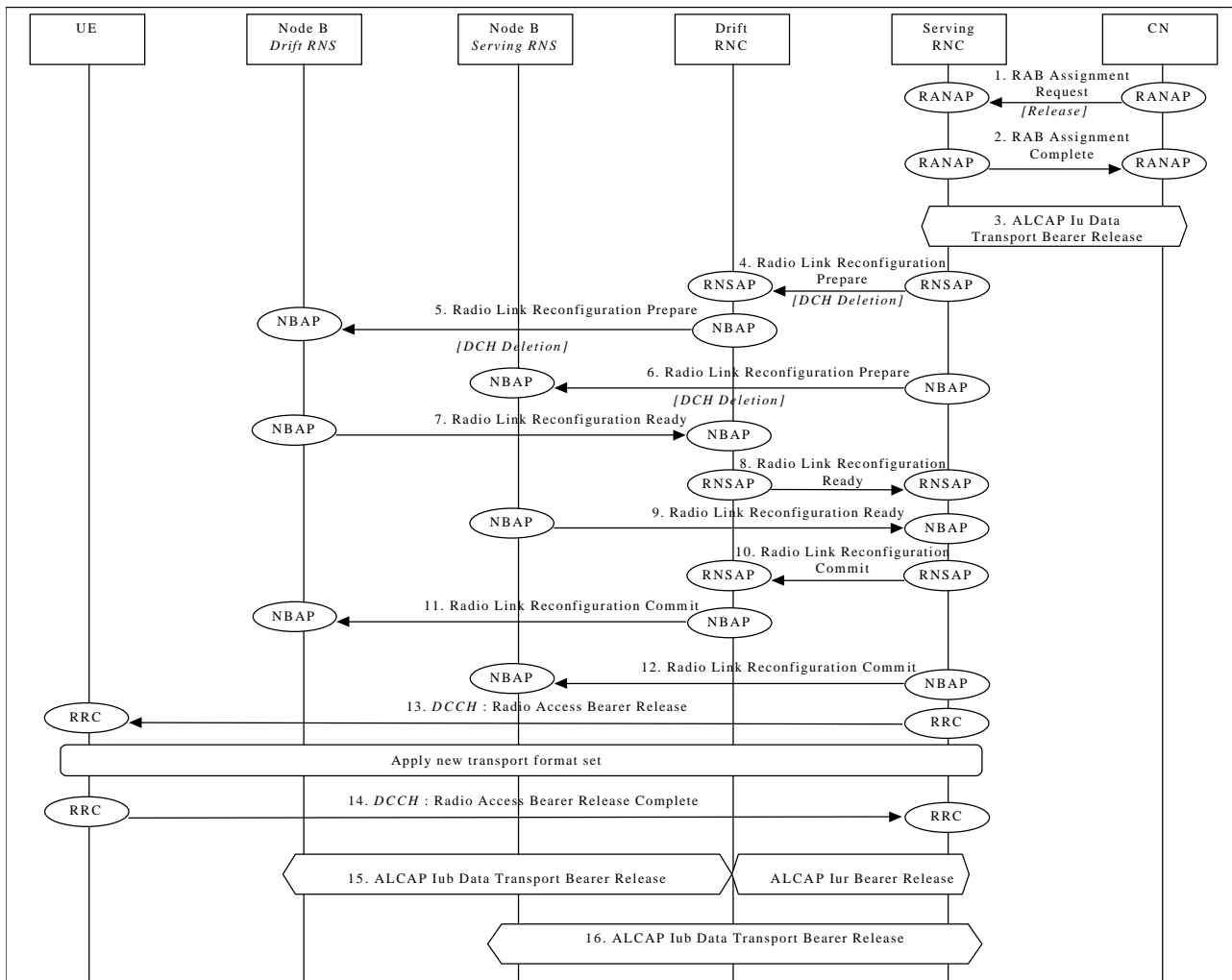

### Radio Access Bearer Release - DCH - DCH Release - Synchronized

1. CN initiates release of the radio access bearer with RANAP message **RAB Assignment Request**.
2. SRNC acknowledges the release of radio access bearer (**RAB Assignment Complete**).
3. SRNC initiates release of the Iu Data Transport bearer between the CN and the SRNC using the ALCAP protocol.
4. SRNC requests DRNC to prepare release of DCH carrying the RAB (**Radio Link Reconfiguration Request**).  
Parameters: Transport Format Combination Set, UL scrambling code.  
This step is applicable only when more Nodes B are involved.
5. DRNC requests its Node B to prepare release of DCH carrying the RAB (**Radio Link Reconfiguration Prepare**).  
Parameters: Transport Format Combination Set, UL scrambling code, DL channelisation code.  
This step is applicable only when more Nodes B are involved.
6. SRNC requests its Node B to prepare release of DCH carrying the RAB (**Radio Link Reconfiguration Prepare**).  
Parameters: Transport Format Combination Set, UL scrambling code (FDD only), Time Slots (TDD only), User Codes (TDD only).

7. Node B notifies DRNC that release preparation is ready (**Radio Link Reconfiguration Ready**).  
This step is applicable only when more Nodes B are involved.
8. DRNC notifies SRNC that release preparation is ready (**Radio Link Reconfiguration Proceed**).  
This step is applicable only when more Nodes B are involved.
9. Node B notifies SRNC that release preparation is ready (**Radio Link Reconfiguration Ready**).  
Parameters: DL channelisation code per cell (FDD only).
10. RNSAP message **Radio Link Reconfiguration Commit** is sent from SRNC to DRNC.  
This step is applicable only when more Nodes B are involved.
11. NBAP message **Radio Link Reconfiguration Commit** is sent from DRNC to Node B.  
This step is applicable only when more Nodes B are involved.
12. NBAP message **Radio Link Reconfiguration Commit** is sent from SRNC to Node B.  
Parameters:
13. RRC message **Radio Access Bearer Release** is sent by SRNC to UE.  
Parameters: Transport Format Set, Transport Format Combination Set, DL channelisation code per cell. (FDD only), Time Slots (TDD only), User Codes (TDD only).
14. UE sends RRC message **Radio Access Bearer Release Complete** to SRNC.
15. Not used resources in-DRNC and NodeB (Drift RNS) are released. DRNC initiates release of Iur and Iub (Drift RNS) Data Transport bearer using ALCAP protocol  
This step is applicable only when more Nodes B are involved.
16. Not used resources in SRNC and NodeB (Serving RNS, if any) are released. SRNC initiates release of Iub (Serving RNS) Data Transport bearer using ALCAP protocol.

## DCH - DCH Release - Unsynchronized

This example shows release of a radio access bearer on a dedicated channel (DCH) when the RRC connection still uses a dedicated channel (DCH) after the release. The UE communicates via two Nodes B. One Node B is controlled the SRNC, one Node B is controlled by DRNC. The reconfiguration does not require to be synchronised among Node-Bs, SRNC and UE.

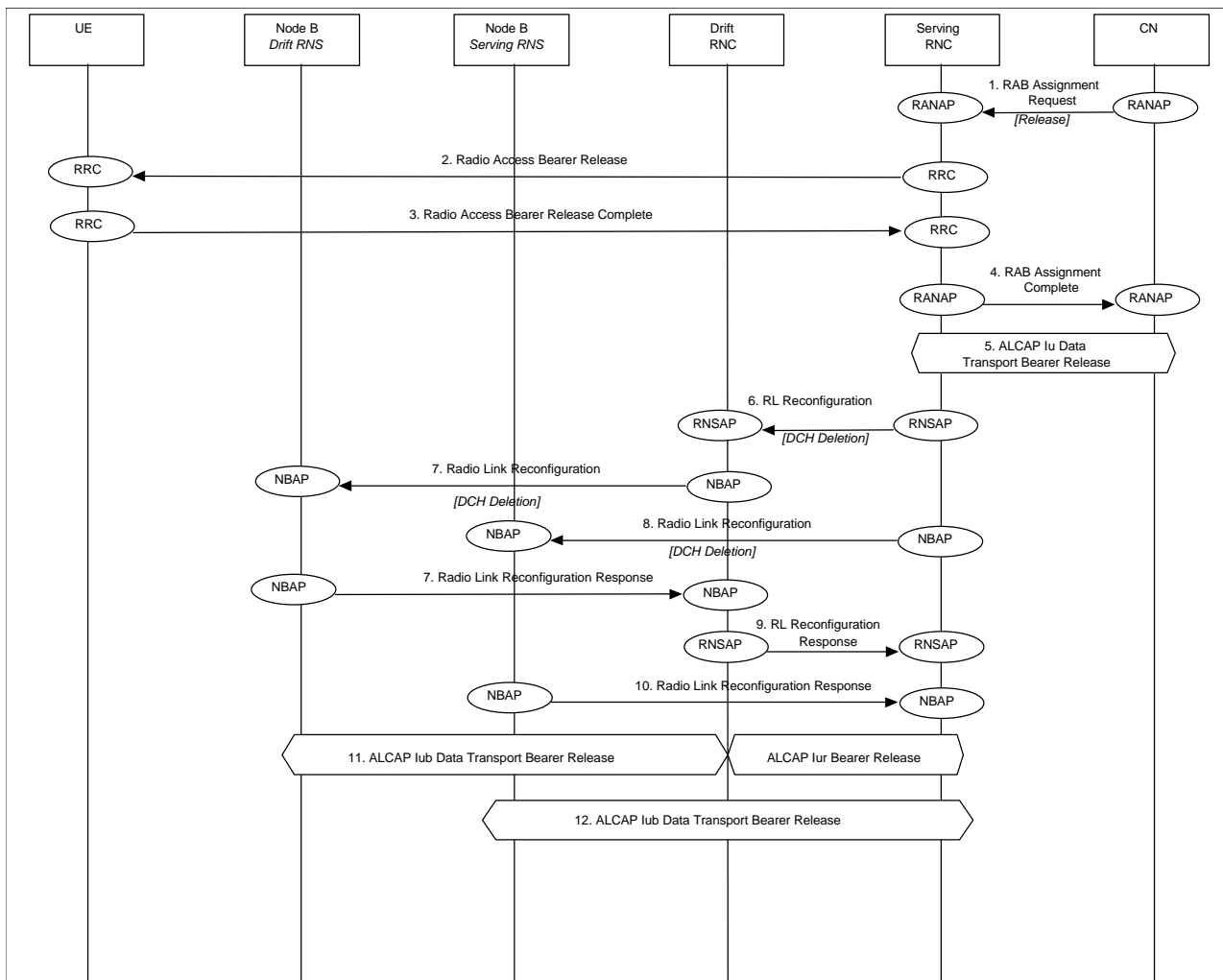

### Radio Access Bearer Release - DCH - DCH Release - Unsynchronised

1. CN initiates release of the radio access bearer with RANAP Radio Access Bearer Assignment Request message.
2. RRC message Radio Access Bearer Release is sent by SRNC to UE.
3. UE sends RRC message Radio Access Bearer Release Complete to SRNC.
4. SRNC acknowledges the release of radio access bearer to CN
5. SRNC initiates release of the Iu Data Transport bearer between the CN and the SRNC using the ALCAP protocol.
6. SRNC requests DRNC to release of DCH carrying the RAB.  
Parameters: Bearer ID, Unsynchronised, TFCS
7. DRNC requests its Node B to release of DCH carrying the RAB.  
Parameters: Bearer ID, Unsynchronised, TFCS
8. SRNC requests its Node B to prepare release of DCH carrying the RAB.  
Parameters: Bearer ID, Unsynchronised, TFCS
9. Node B acknowledges DRNC.
10. DRNC acknowledges SRNC.
11. Node B acknowledges SRNC

12. SRNC initiates release of Iur Data Transport bearer using ALCAP protocol. Note: the release of the Iur link may be done before step 10.

## DCH - RACH/FACH Release

This example shows release of a radio access bearer on a Dedicated channel (DCH) when the RRC connection still uses a Common transport channel (RACH/FACH) after the release (DCH to RACH/FACH).

Note this example shows case where the SRNC decides to perform SRNS Relocation directly at the channel switching.

NOTE: This procedure is FFS

### 4.1.4 RACH/FACH - RACH/FACH Release

This example shows release of a radio access bearer on a common transport channel (RACH/FACH) when the RRC connection still uses a common transport channel (RACH/FACH) after the release (RACH/FACH to RACH/FACH).

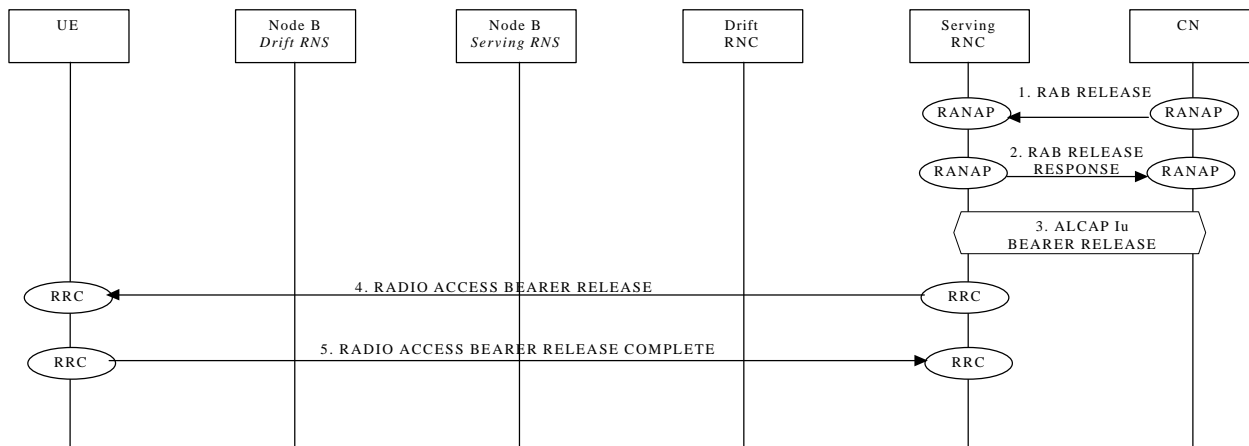

## Radio Access Bearer Re-establishment

The following examples show re-establishment of a radio access bearer either on a dedicated channel (DCH) or on a common transport channel (RACH/FACH) when the RRC connection already uses a dedicated channel (DCH) or a common transport channel (RACH/FACH).

### 4.1.4 DCH - DCH Re-establishment

This example shows re-establishment of a radio access bearer on a dedicated channel (RACH/FACH) when the RRC connection already uses a dedicated channel (DCH).

### 4.1.2 RACH/FACH - DCH Re-establishment

This example shows re-establishment of a radio access bearer on a dedicated channel (RACH/FACH) when the RRC connection already uses a common transport channel (RACH/FACH).

### 4.1.3 RACH/FACH - RACH/FACH Re-establishment

This example shows re-establishment of a radio access bearer on a common transport channel (RACH/FACH) when the RRC connection already uses a common transport channel (RACH/FACH).

## Radio Access Bearer Modification

The following examples show modification of a radio access bearer established either on a dedicated channel (DCH) or on a common transport channel (RACH/FACH).

## 4.1.4DCH to DCH Modification

This example shows modification of a radio access bearer on a dedicated channel (DCH)

### 4.1.2 RACH/FACH TO RACH/FACH Reconfiguration

This example shows reconfiguration of a radio access bearer on a common transport channel (RACH/FACH to RACH/FACH).

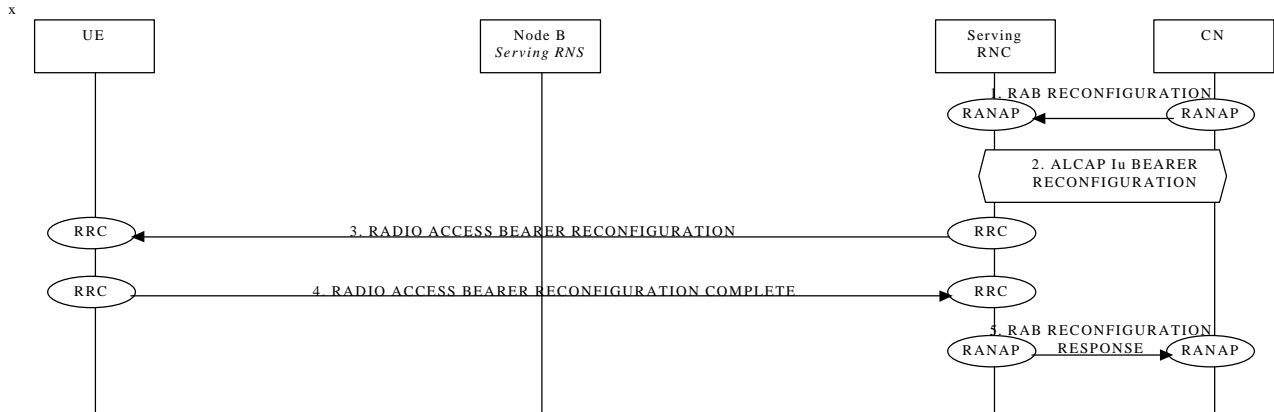

This procedure is FFS. It is not yet clear if the Bearer should be effectively reconfigured or should be removed and set up again

### 4.1.3 RACH/FACH TO DCH Reconfiguration

This example shows reconfiguration of a radio access bearer on a common transport channel (RACH/FACH to DCH)

This procedure is FFS. It is not yet clear if the Bearer should be effectively reconfigured or should be removed and set up again

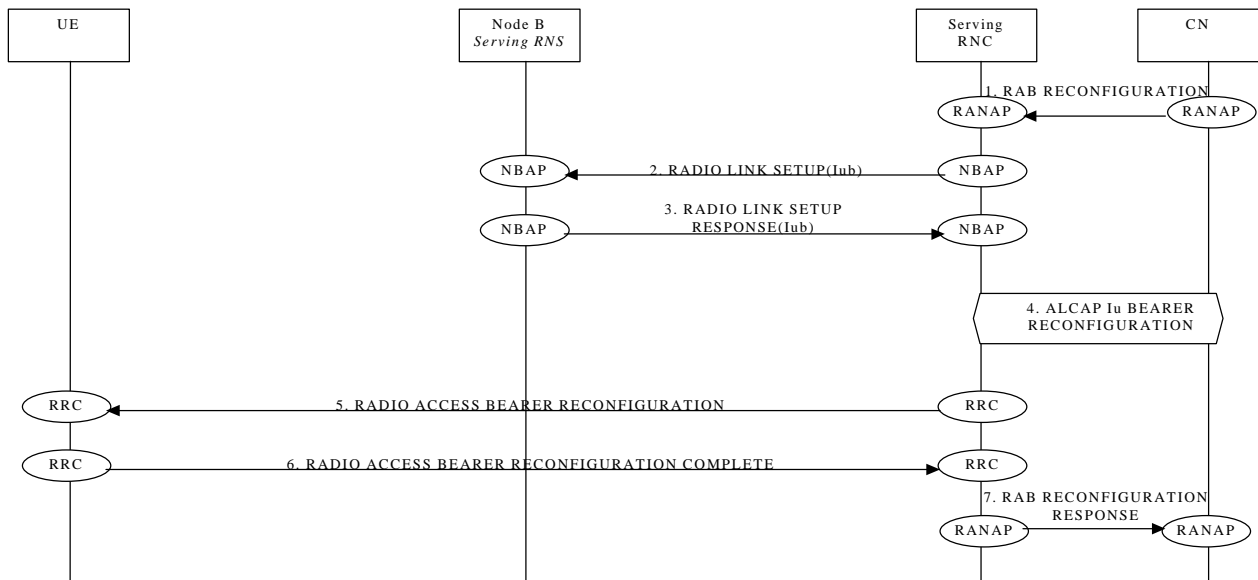



## 4.1.4DCH TO RACH/FACH RECONFIGURATION

This example shows reconfiguration of a radio access bearer on a dedicated channel (DCH to RACH/FACH).

Note: this example shows the case where the SRNC decides to perform SRNS Relocation immediately after the channel switching.

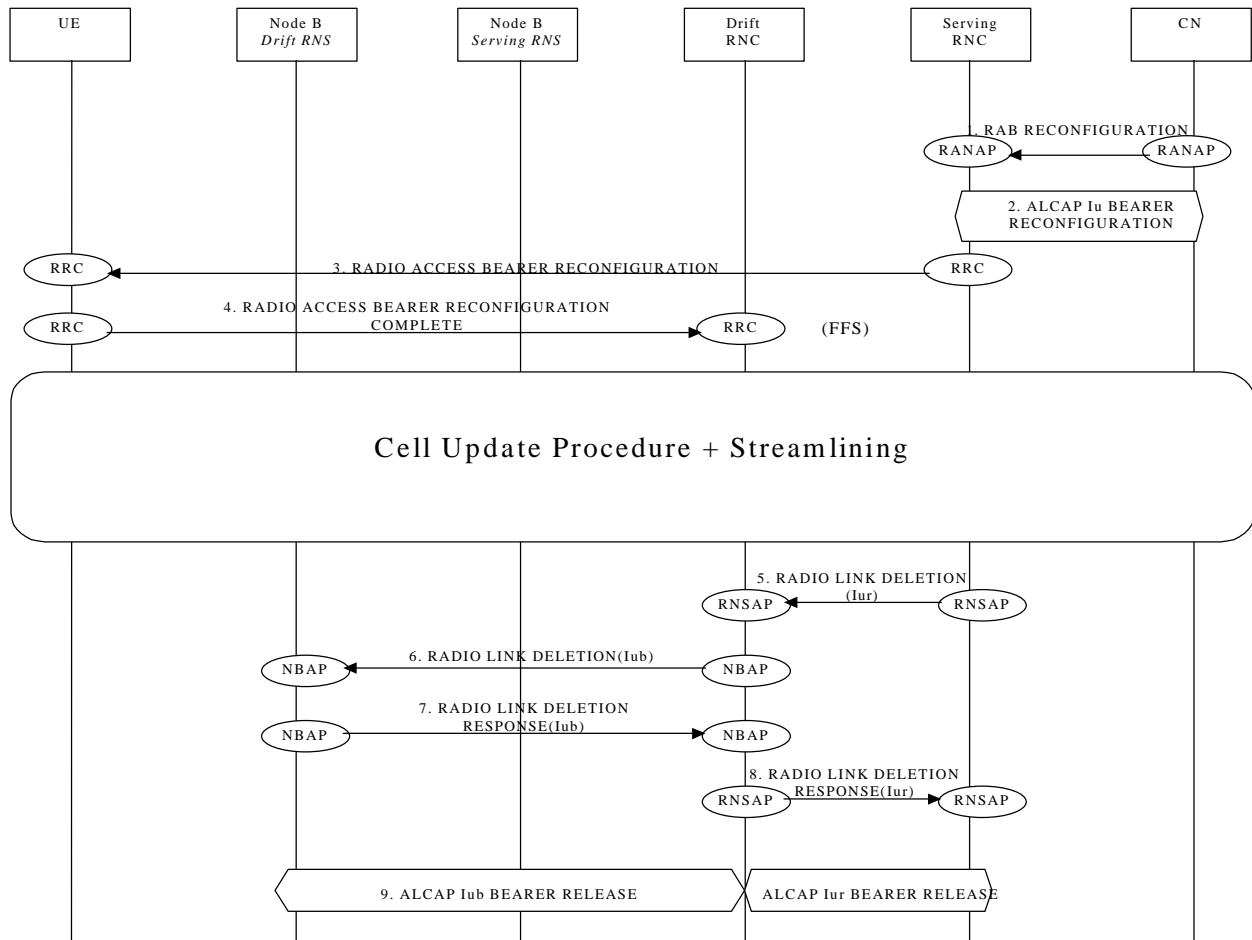

This procedure is FFS.

## Physical Channel Reconfiguration

### Physical Channel Reconfiguration (DCH)

The following example show the reconfiguration from one channel type to another (DCH to DCH) an example for the Physical Channel Reconfiguration procedure on a dedicated channel (DCH).

This procedure can be used, for example, to change the UL scrambling code of a UE.

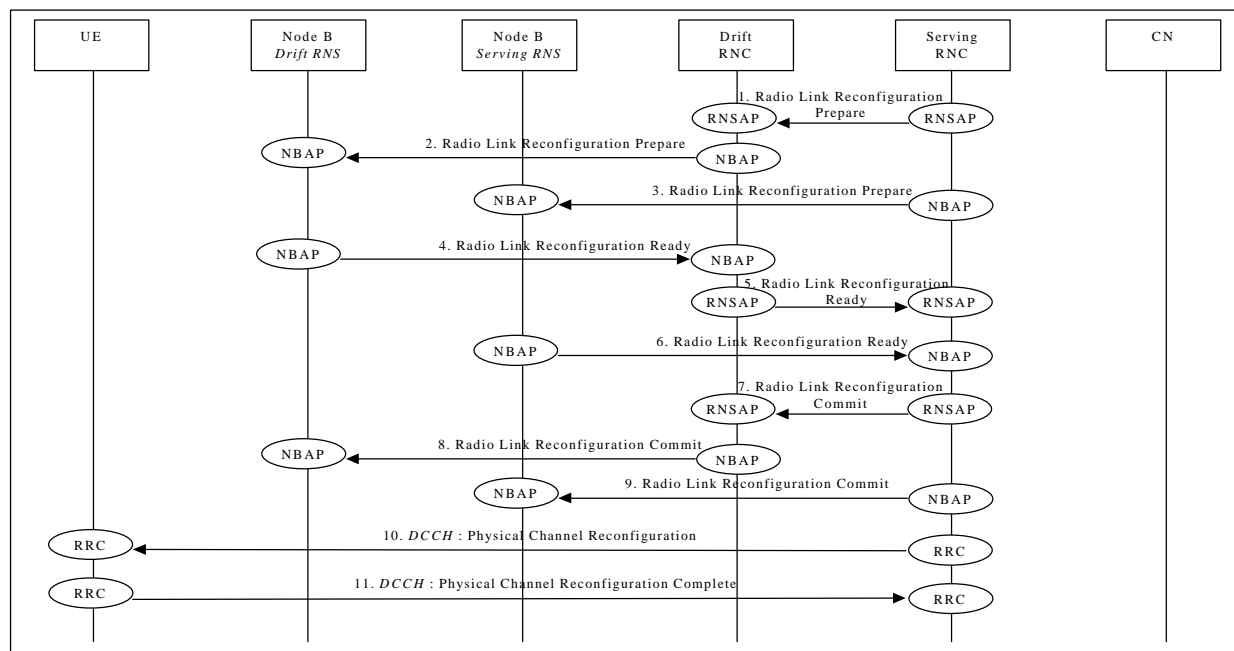

### Physical Channel Reconfiguration

1. SRNC decided that there is a need for a Physical Channel Reconfiguration and requests DRNC to prepare reconfiguration of DCH (**Radio Link Reconfiguration Prepare**).  
Parameters: UL scrambling code (FDD only), Power control information.
2. DRNC requests its Node B to prepare reconfiguration of physical channel (**Radio Link Reconfiguration Prepare**).  
Parameters: Power control information, UL scrambling code (FDD only), DL channelisation code (FDD only), Time Slots (TDD only), User Codes (TDD only).
3. SRNC requests its Node B to prepare reconfiguration of physical channel (**Radio Link Reconfiguration Prepare**).  
Parameters: Power control information, UL scrambling code (FDD only), DL channelisation code (FDD only), Time Slots (TDD only), User Codes (TDD only).
4. Node B allocates resources and notifies DRNC that the reconfiguration is ready (**Radio Link Reconfiguration Ready**).  
Parameters: Transport layer addressing information (AAL2 address, AAL2 Binding Id) for Iub Data Transport Bearer.
5. DRNC notifies SRNC that the reconfiguration is ready (**Radio Link Reconfiguration Ready**).  
Parameters: Transport layer addressing information (AAL2 address, AAL2 Binding Id) for Iur Data Transport Bearer.
6. Node B allocates resources and notifies SRNC that the reconfiguration is ready (**Radio Link Reconfiguration Ready**).

Parameters: Transport layer addressing information (AAL2 address, AAL2 Binding Id) for Iub Data Transport Bearer.

7. RNSAP message **Radio Link Reconfiguration Commit** is sent from SRNC to DRNC.

Parameters: CFN.

8. NBAP message **Radio Link Reconfiguration Commit** is sent from DRNC to Node B.

Parameters: CFN.

9. NBAP message **Radio Link Reconfiguration Commit** is sent from SRNC to Node B.

Parameters: CFN.

10. RRC message **Physical Channel Reconfiguration** is sent by SRNC to UE.

Parameters: UL scrambling code (FDD only), DL channelisation code per cell (FDD only), Time Slots (TDD only), User Codes (TDD only), CFN.

11. UE sends RRC message **Physical Channel Reconfiguration Complete** to SRNC.

## Physical Channel Reconfiguration (CRNC Controlled)

This procedure shall be used to reconfigure the Physical Channel in the CRNC; in case of FDD it corresponds to the Down Link Code Reconfiguration Procedure, while in TDD it allows to change either TS or User Code.

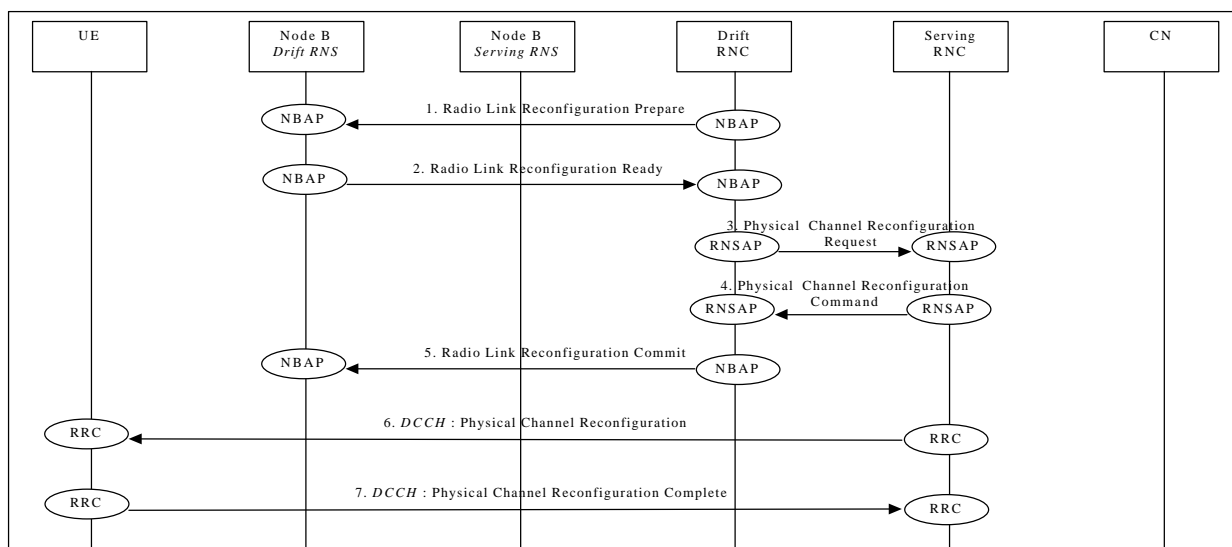

### Physical Channel Reconfiguration (CRNC Controlled)

1. DRNC requests its Node B to reconfigure the physical channel (**Radio Link Reconfiguration Prepare**).  
Parameters: Power control information, DL channelisation code per cell (FDD only), Time Slots (TDD only), User Codes (TDD only).
2. Node B allocates resources and notifies DRNC that the reconfiguration is ready (**Radio Link Reconfiguration Ready**).  
Parameters: Transport layer addressing information (AAL2 address, AAL2 Binding Id) for Iub Data Transport Bearer.

3. DRNC decides that a Physical Channel Reconfiguration is needed and sends the RNSAP message **Physical Channel Reconfiguration Request** to the SRNC.
4. SRNC determines the CFN in which to perform the physical channel reconfiguration and sends the message **Physical Channel Reconfiguration Command**.
5. NBAP message **Radio Link Reconfiguration Commit** is sent from DRNC to Node B.  
Parameters: CFN.
6. RRC message **Physical Channel Reconfiguration** is sent by SRNC to UE.  
Parameters: DL channelisation code per cell (FDD only), Time Slots (TDD only), User Codes (TDD only), CFN.
7. After the reconfiguration, the UE sends RRC message **Physical Channel Reconfiguration Complete** to SRNC.

## Channel Type Switching

The following examples show switching from one channel type to another.

### 4.1.1 RACH/PCH to RACH/FACH

This example shows channel switching from RACH/PCH to RACH/FACH (URA connected to CELL Connected).

Note: The case showed is for when SRNS decides to perform an SRNS relocation immediately after a channel type switching.

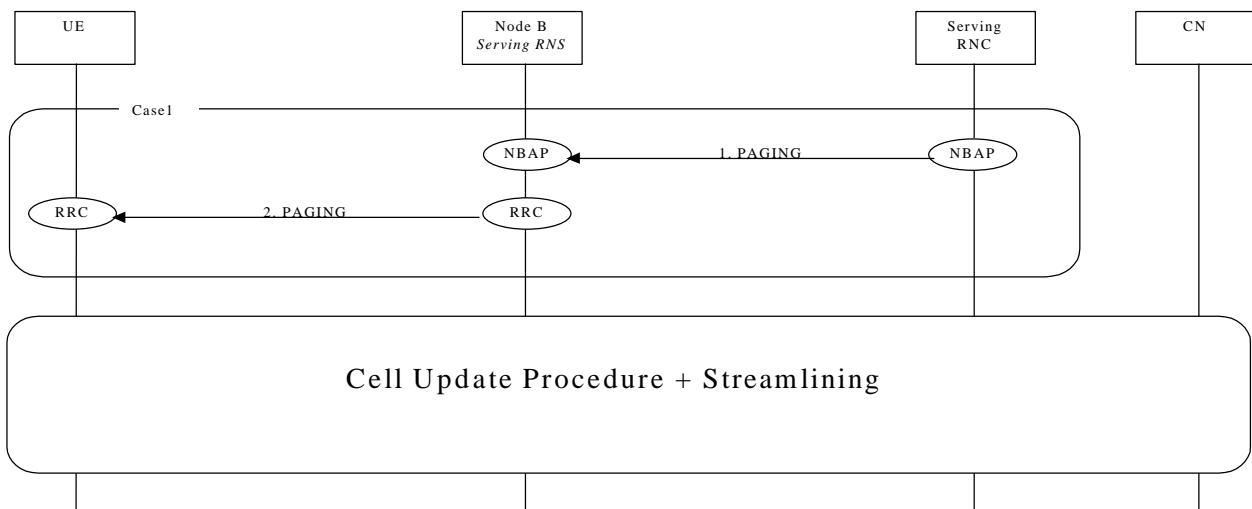

NOTE: The first and the second transition are included when the procedure is initiated by UTRAN

### 4.1.2 RACH/FACH to RACH/PCH

The procedure for channel switching from RACH/FACH to RACH/PCH (Cell Connected to URA connected) is described in [Editor note: appropriate reference to the WG2 documentation is needed].

### 4.1.3 RACH/FACH to DCH

This example shows channel switching from RACH/FACH to DCH.

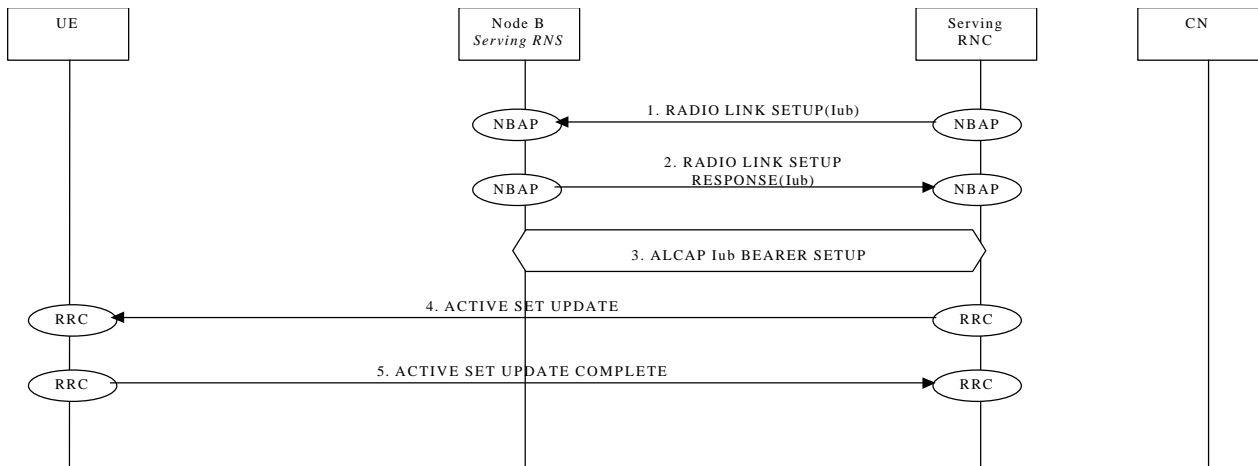

## 4.1.4DCH to RACH/FACH

This example shows channel switching from DCH to RACH/FACH.

### 4.1.1.4DCH to RACH/FACH (SRNS Relocation)

The case showed is for when SRNS decides to perform an SRNS relocation immediately after a channel type switching.

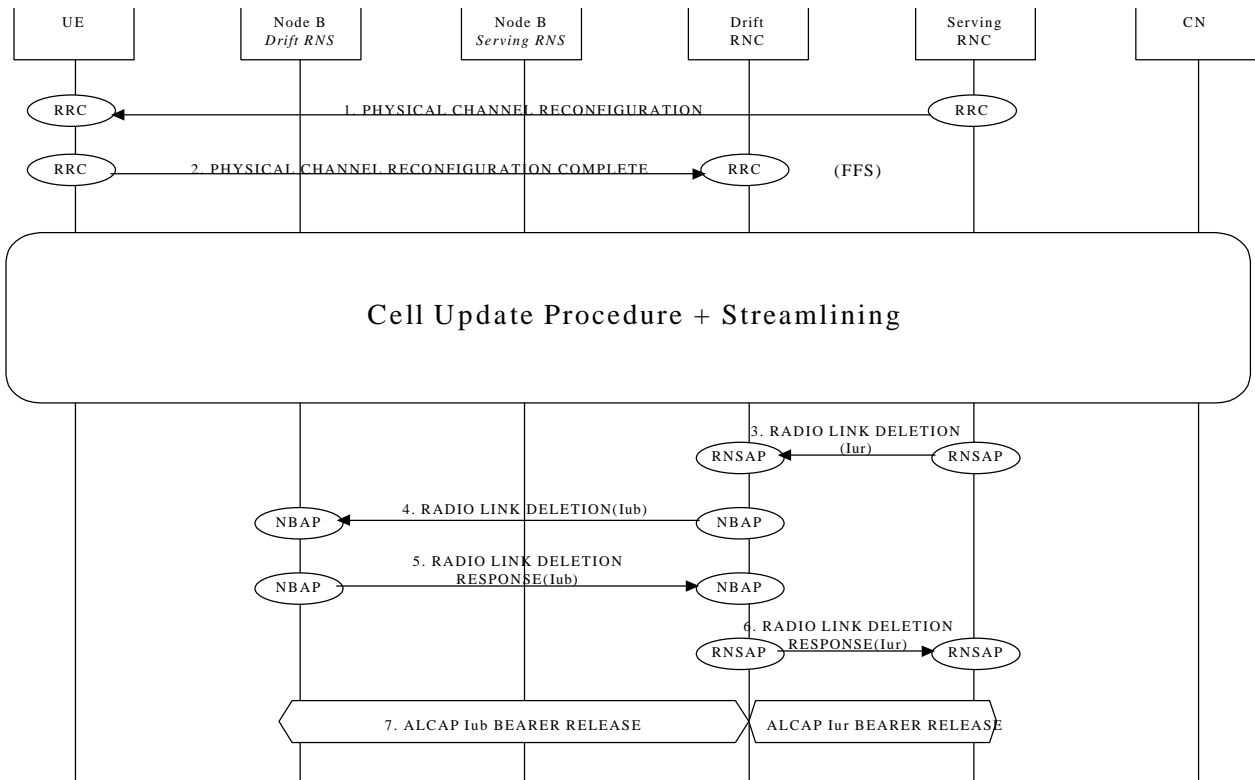

### 4.1.1.2DCH to RACH/FACH (without SRNS Relocation)

## Soft Handover

This section presents some examples of soft handover procedures. The following cases are considered:

- Radio Link Addition (Branch Addition);
- Radio link Deletion (Branch Deletion);
- Radio link Addition & Deletion (Branch Addition & Deletion - simultaneously).

Note that Soft Handover applies only to FDD mode.

### 4.1.4 Radio Link Addition (Branch Addition)

This example shows establishment of a radio link via a Node B controlled by another RNC than the serving RNC. This is the first radio link to be established via this RNS, thus macro-diversity combining/splitting with already existing radio links within DRNS is not possible.

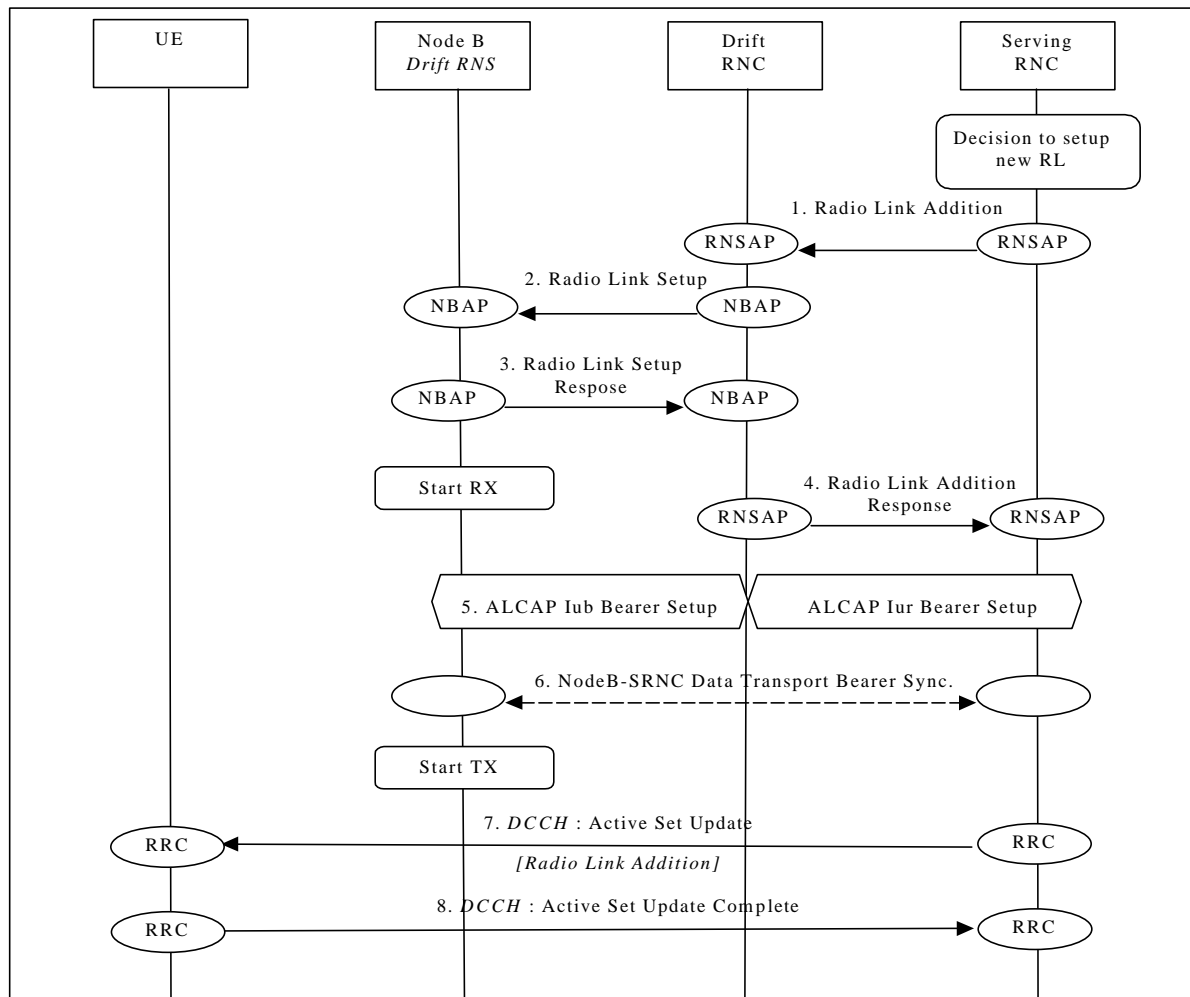

#### Soft Handover - Radio Link Addition (Branch Addition)

1. SRNC decides to setup a radio link via a new cell controlled by another RNC. SRNC requests DRNC for radio resources by sending RNSAP message **Radio Link Addition**. If this is the first radio link via the DRNC for this UE, a new Iur signalling connection is established. This Iur signalling connection will be used for all RNSAP signalling related to this UE.  
Parameters: Cell id, Transport Format Set per DCH, Transport Format Combination Set, frequency, UL scrambling code.
2. If requested resources are available, DRNC sends NBAP message **Radio Link Setup** to Node B.  
Parameters: Cell id, Transport Format Set per DCH, Transport Format Combination Set, frequency, UL scrambling code, DL channelisation code.
3. Node B allocates requested resources. Successful outcome is reported in NBAP message **Radio Link Setup Response**.  
Parameters: Signalling link termination, Transport layer addressing information (AAL2 address, AAL2 Binding Identitie(s)) for Data Transport Bearer(s).

Then Node B starts the UL reception.

4. DRNC sends RNSAP message **Radio Link Addition Response** to SRNC.  
Parameters: DL channelisation code, Transport layer addressing information (AAL2 address, AAL2 Binding Identity) for Data Transport Bearer(s), Neighbouring cell information.
5. SRNC initiates setup of Iur/Iub Data Transport Bearer using ALCAP protocol. This request contains the AAL2 Binding Identity to bind the Iub Data Transport Bearer to DCH.  
This may be repeated for each Iur/Iub Data Transport Bearer to be setup.
6. Node B and SRNC establish synchronism for the Data Transport Bearer(s), relative already existing radio link(s). Then Node B starts DL transmission.
7. SRNC sends RRC message **Active Set Update** (Radio Link Addition) to UE on DCCH.  
Parameters: Update type, Cell id, DL scrambling code, DL channelisation code, Power control information, Ncell information.
8. UE acknowledges with RRC message **Active Set Update Complete**.

## Radio link Deletion (Branch Deletion)

This example shows deletion of a radio link belonging to a Node B controlled by another RNC than the serving RNC.

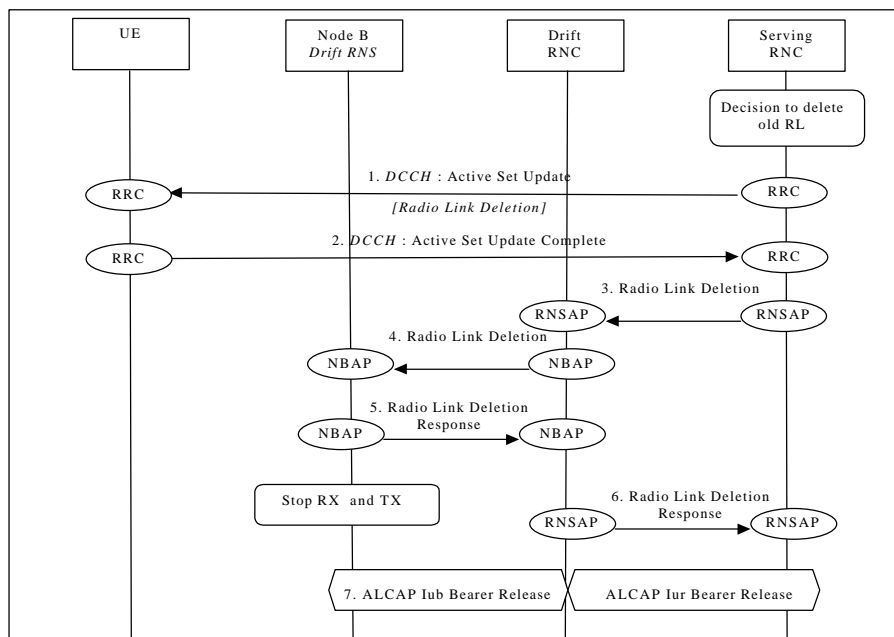

### Soft Handover - Radio Link Deletion (Branch Deletion)

1. SRNC decides to remove a radio link via an old cell controlled by another RNC. SRNC sends RRC message **Active Set Update** (Radio Link Deletion) to UE on DCCH.  
Parameters: Update type, Cell id.
2. UE deactivates DL reception via old branch, and acknowledges with RRC message **Active Set Update Complete**.
3. SRNC requests DRNC to deallocate radio resources by sending RNSAP message **Radio Link Deletion**.  
Parameters: Cell id, Transport layer addressing information.
4. DRNC sends NBAP message **Radio Link Deletion** to Node B.  
Parameters: Cell id, Transport layer addressing information.
5. Node B deallocates radio resources. Successful outcome is reported in NBAP message **Radio Link Deletion Response**.



6. DRNC sends RNSAP message **Radio Link Deletion Response** to SRNC.
7. SRNC initiates release of Iur/Iub Data Transport Bearer using ALCAP protocol.

### 4.4.3 Radio link Addition & Deletion (Branch Addition & Deletion - simultaneously)

This example shows simultaneous deletion of a radio link belonging to a Node B controlled by the serving RNC and the establishment of a radio link via a Node B controlled by another RNC than the serving RNC. This is the first radio link to be established via this RNS, thus macro-diversity combining/splitting with already existing radio links within DRNS is not possible.

This procedure is needed when the maximum number of branches allowed for the macrodiversity set has already been reached.

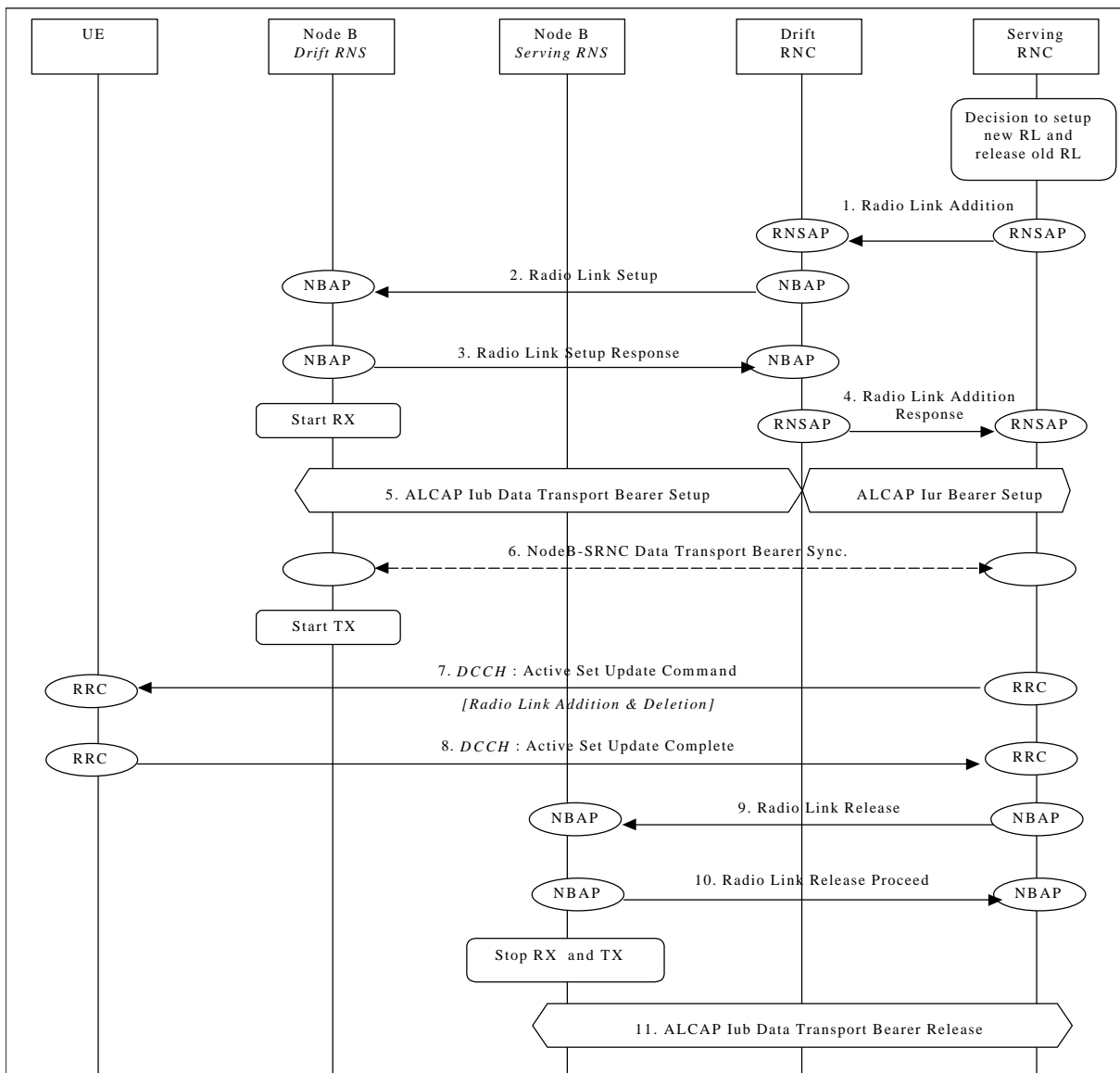

#### Soft Handover - Radio link Addition & Deletion (Branch Addition & Deletion - simultaneously)

1. ⇒ 6. See description 1. ⇒ 6. in Section 9.12.1.

7. SRNC sends RRC message **Active Set Update** (Radio Link Addition & Deletion) to UE on DCCH.  
Parameters: Update type, Cell id, DL scrambling code, DL channelisation code, Power control information, Ncell information.
8. UE deactivates DL reception via old branch, activates DL reception via new branch and acknowledges with RRC message **Active Set Update Complete**.
9. ⇒ 11. See description 3. ⇒ 7. in Section 9.12.2

## Hard Handover

This section presents some examples of hard handover procedures. These are procedures for both dedicated and common channels and may be applied in the following cases:

- intra-frequency Hard Handover (TDD mode);
- inter-frequency Hard Handover (FDD and TDD mode).

### 4.4.4 Backward Hard Handover

This section shows some examples of hard handover in the case of network initiated backward handovers

## 4.1.1.1 Intra Node B Hard Handover (DCH State)

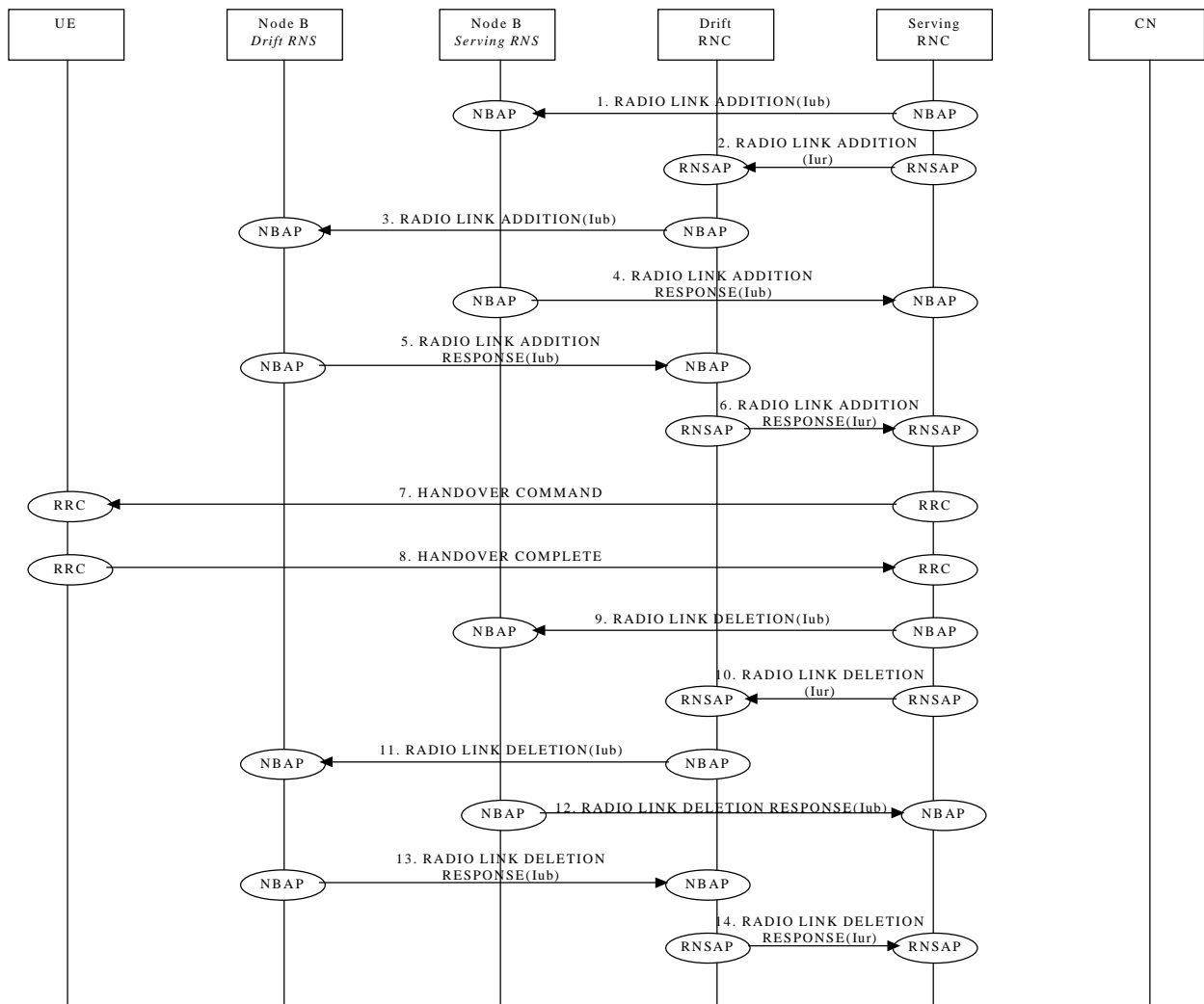

### 4.1.1.2 Hard Handover via Iur (DSCH/DCH State)

This section shows an example of Hard Handover via Iur.

Note: this procedure is for FFS.

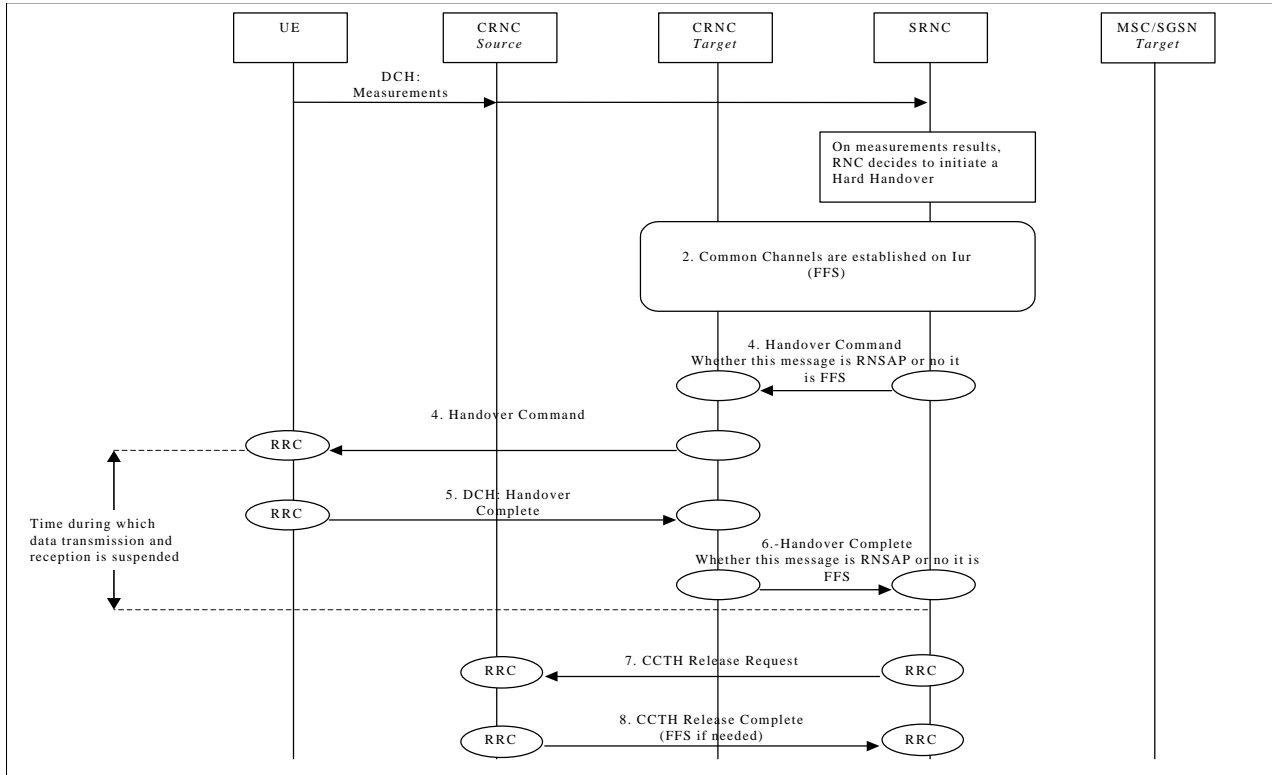

### Hard Handover via Iur

### 4.1.1.3 Hard Handover via Iur (DCH State)

This section shows an example of Hard Handover via Iur, when the mobile is in DCH state

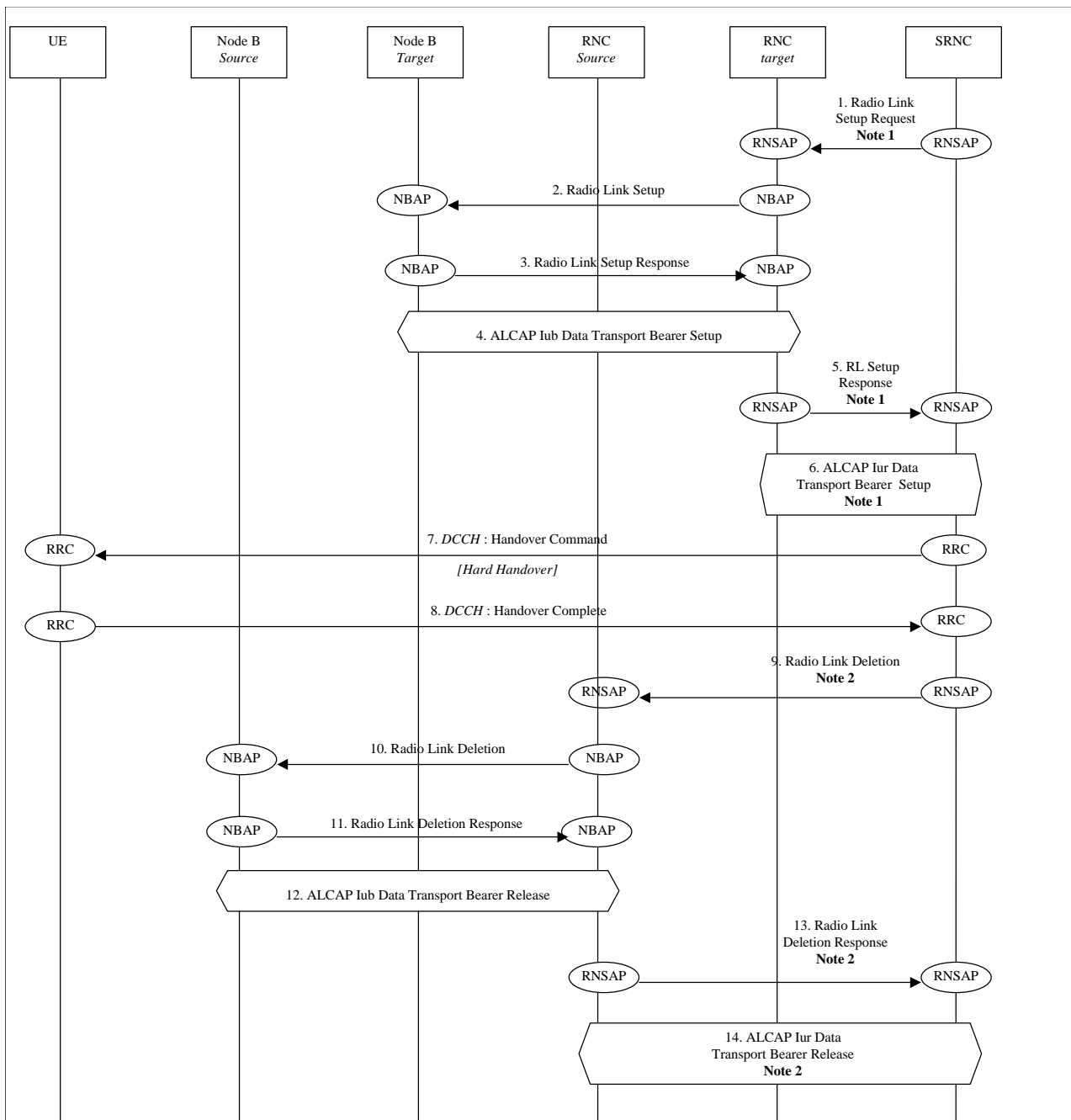

### Hard Handover via Iur (DCH on Iur)

- SRNC sends **Radio Link Setup Request** message to the target RNC.  
Parameters: target RNC identifier, s-RNTI, Cell id, Transport Format Set, Transport Format Combination Set. *Note 1: This message is not necessary when the target RNC is the SRNC.*
- The target RNC allocates RNTI and radio resources for the RRC connection (if possible), and sends the NBAP message **Radio Link Setup** to the target Node-B. Parameters: Cell id, Transport Format Set, Transport Format Combination Set, frequency, UL scrambling code (FDD only), Time Slots (TDD only), User Codes (TDD only), DL channelisation code (FDD only), Power control information.
- Node B allocates resources, starts PHY reception, and responds with NBAP message **Radio Link Setup Response**.  
Parameters: Signalling link termination, Transport layer addressing information for the Iub Data Transport Bearer.

4. Target RNC initiates set-up of Iub Data Transport bearer using ALCAP protocol. This request contains the AAL2 Binding Identity to bind the Iub Data Transport Bearer to the DCH. The request for set-up of Iub Data Transport bearer is acknowledged by Node B.
5. When the Target RNC has completed preparation phase, **Radio Link Setup Response** is sent to the SRNC. *Note 1: This message is not necessary when the target RNC is the SRNC.*
6. SRNC initiates set-up of Iur Data Transport bearer using ALCAP protocol. This request contains the AAL2 Binding Identity to bind the Iur Data Transport Bearer to the DCH. The request for set-up of Iur Data Transport bearer is acknowledged by Target RNC. *Note 1: This message is not necessary when the target RNC is the SRNC*
7. SRNC sends a RRC message **Handover Command** to the UE.
8. When the RRC connection is established with the target RNC and necessary radio resources have been allocated the UE sends RRC message **Handover Complete** to the SRNC.
9. The SRNC sends a RNSAP message **Radio Link Deletion** to the source RNC. *Note 2: This message is not necessary when the source RNC is the SRNC.*
10. The source RNC sends NBAP message **Radio Link Deletion** to the source Node B.  
Parameters: Cell id, Transport layer addressing information.
11. The source Node B de-allocates radio resources. Successful outcome is reported in NBAP message **Radio Link Deletion Response**.
12. The source RNC initiates release of Iub Data Transport bearer using ALCAP protocol.
13. When the source RNC has completed the release the RNSAP message Radio Link Deletion Response is sent to the SRNC. *Note 2: This message is not necessary when the source RNC is the SRNC.*
14. SRNC initiates release of Iur Data Transport bearer using ALCAP protocol. This request contains the AAL2 Binding Identity to bind the Iur Data Transport Bearer to the DCH. The request for release of Iur Data Transport bearer is acknowledged by the Source RNC. *Note 2: This message is not necessary when the source RNC is the SRNC.*

#### 4.1.1.4 Hard Handover with switching in the CN (UE connected to two CN nodes, DCH state)

This example shows Inter-RNS Hard Handover with switch in CN, in a situation in which the UE is connected to two CN nodes simultaneously and will be using one node B directly under the target RNC after the hard handover.

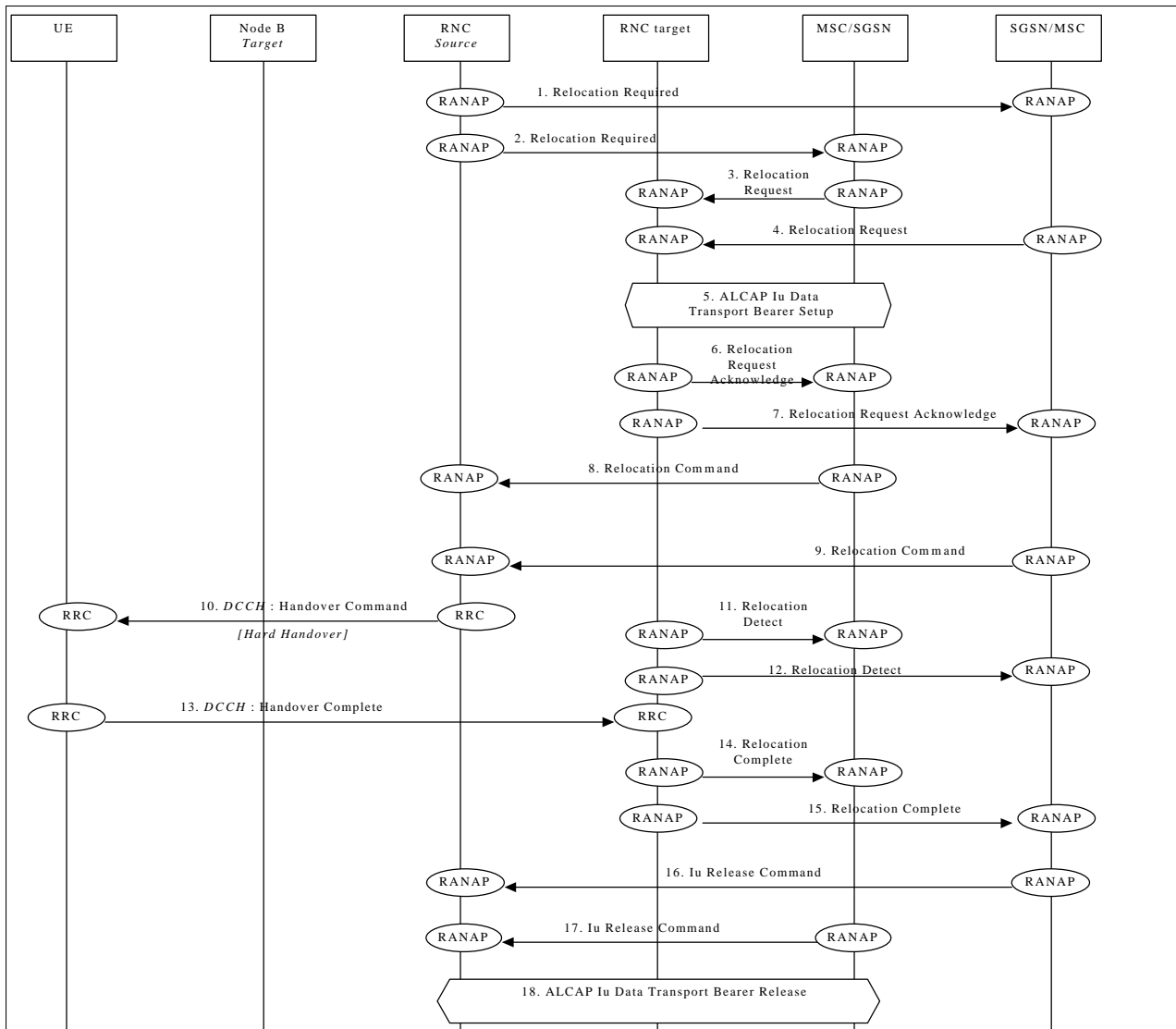

### Hard Handover with switching in the CN (UE connected to two CN nodes, DCH state)

Serving RNC makes the decision to perform the Hard Handover via CN. Serving RNC also decides into which RNC (Target RNC) the Serving RNC functionality is to be relocated.

- 1./2. SRNC sends **Relocation Required** messages to both CN nodes.  
Parameters: target RNC identifier, Information field transparent to the CN node and to be transmitted to the target RNC.  
Upon reception of **Relocation Required** message CN element prepares itself for the switch and may also suspend data traffic between UE and itself for some bearers.
- 3./4. When preparation is completed CN node conveys a **Relocation Request** message to the target RNC.  
Parameters: bearer ID's requested to be rerouted towards the CN node, from which the **Relocation Request** originated.  
CN indicates in the message whether it prefers point to multipoint type of connections within CN or hard switch in CN. In this example the latter is assumed.  
Target RNC allocates necessary resources within the UTRAN to support the radio links to be used after completion of the Hard Handover procedure.
- 5./6./7. Target RNC and CN node establish the new Iu transport bearers for each Radio Access Bearer related to the CN node. When RNC has completed preparation phase, **Relocation Request Acknowledge** is sent to the CN element.  
Parameters: transparent field to the CN which is to be transmitted to the Source RNS.

- .8./9. When CN is ready for the change of SRNC, CN node sends a **Relocation Command** to the RNC. Message contains the transparent field provided by Target RNC.  
Parameters: information provided in the Information field from the target RNC.
9. Source RNC sends a RRC message **Handover Command** (Hard Handover) to the UE.  
Parameters: Handover type.
- 11./12. When target RNC has detected the UE, **Relocation Detect** message is sent to the CN nodes. Target RNC switches also the connection towards the new Iu, when UE is detected. After the switch UL traffic from node-B's is routed via the newly established MDC to the new MAC/RLC entities and finally to the correct Iu transport bearer.  
DL data arriving from the new Iu link is routed to newly established RLC entities, to the MAC and to the MD-splitter and Nodes B.
13. When the RRC connection is established with the target RNC and necessary radio resources have been allocated the UE sends RRC message **Handover complete** to the target RNC.
- 14./15. After a successful switch and resource allocation at target RNC, RNC sends **Relocation Complete** messages to the involved CN nodes.  
  
At any phase, before the **Relocation Complete** message is sent, the old communication link between the CN and UE is all the time existing and working and the procedure execution can be stopped and original configuration easily restored. If any such unexceptional thing occurs a **Relocation Failure** message may be sent instead of any message numbered 3-10 and 13-14 described in this above.
- 16./17. The CN nodes initiates the release of the Iu connections to the source RNC by sending RANAP message **Iu Release Command**.
18. Upon reception of the release requests from the CN nodes the old SRNC executes all necessary procedures to release all visible UTRAN resources that were related to the RRC connection in question.

## 4.1.2 Forward Hard Handover

This sections shows some examples of hard handover in the case of mobile initiated forward handovers.

Some examples of Cell Update procedures are shown, i.e. those procedures that update the position of the UE when a RRC connection exists and the position of the UE is known on cell level in the UTRAN.

### Cell Update with SRNS relocation

This example shows Inter-RNS Cell Update with switching in the CN (with SRNS relocation).

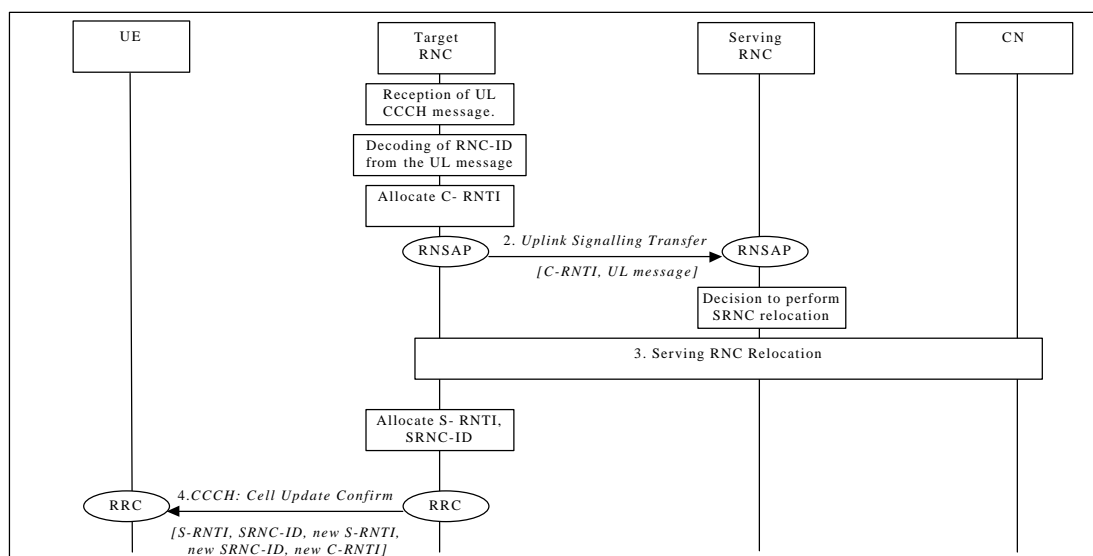

### Cell Update with SRNS Relocation

1. UE sends a RRC message Cell Update to the UTRAN, after having made cell re-selection. Upon reception of a CCCH message from a UE, controlling RNC allocates a C-RNTI for the UE.



2. Controlling RNC forward the received uplink CCCH message towards the SRNC by RNSAP Cell/URA Update Indication message. C-RNC includes the allocated C-RNTI to the RNSAP message, which is used as a UE identification within the C-RNC. Upon reception of the RNSAP message SRNC decides to perform a SRNS Relocation towards the target RNC.
3. Serving RNC relocation procedure is executed as defined in Chapter SRNS Relocation (UE connected to a single CN node). After completing SRNS Relocation, target RNC allocates new S-RNTI for the UE.
4. Serving RNC responds to UE by RRC Cell Update Confirm, including old S-RNTI and SRNC ID as UE identifiers. Message contains also the new S-RNTI, SRNC-ID and C-RNTI.

It is ffs. whether a Cell Update Complete is needed to confirm the successful reception of Cell Update Confirm. The decision is to be made by 3GPP RAN WG2.

### Cell Update via Iur without SRNS relocation

This example shows an Inter RNS cell update in DRNS without SRNS relocation when no Iur RACH/FACH transport bearer exists. In this example target RNS, source RNS and serving RNS are all located separately from each other. Other scenarios can be easily derived from this most comprehensive signalling procedure.

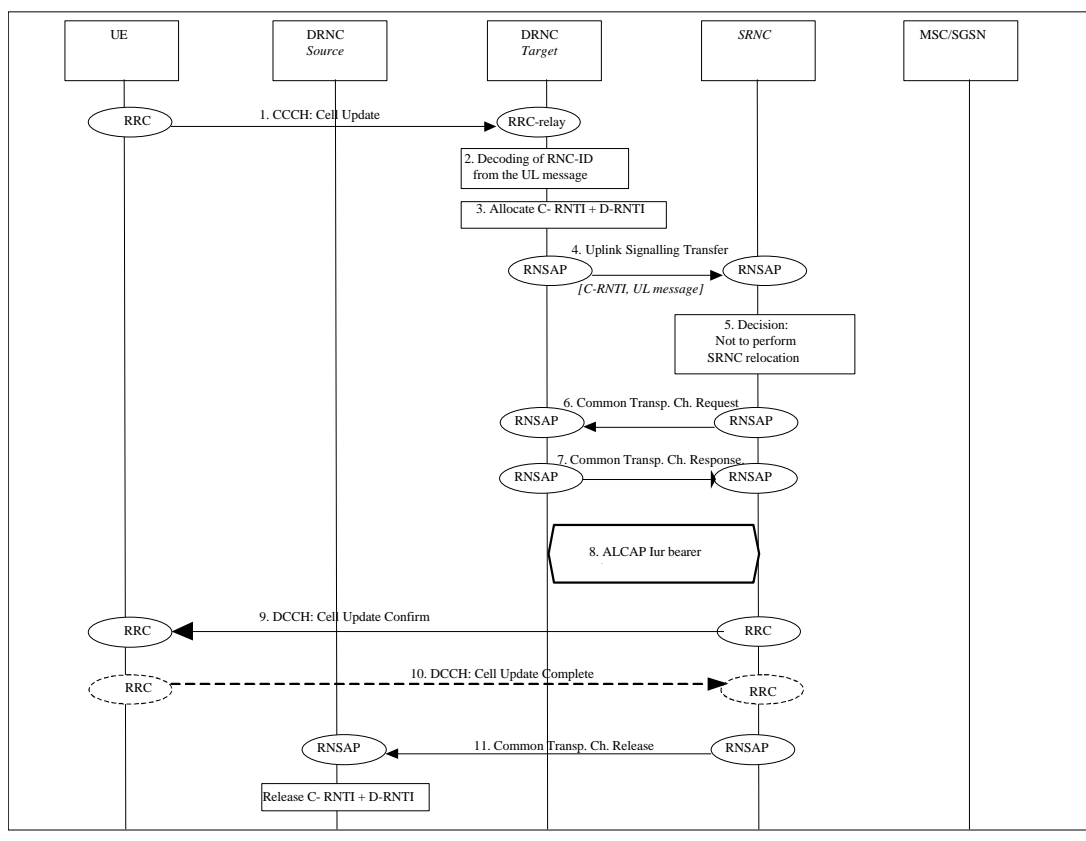

### Cell Update via Iur without SRNS Relocation

1. UE sends an RRC message Cell Update to the UTRAN, after having made cell re-selection.
2. Upon reception of a CCCH message from a UE, the target DRNC decodes the SRNC ID and the S-RNTI.
3. The UE is not registered in the target DRNC (RNC ID and SRNTI unknown), thus the target DRNC allocates a C-RNTI and a D-RNTI for the UE.

4. The target DRNC forwards the received uplink CCCH message towards the SRNC in the RNSAP Uplink Signalling Transfer message. The Uplink Signalling Transfer message includes also the cell-ID of the cell from which the CCCH message was received, the D-RNTI and the allocated C-RNTI.
5. Upon reception of the Uplink Signalling Transfer message the SRNC decides not to perform a SRNS Relocation towards the target RNC.
6. The SRNC initialises the UE context in the target RNC with the RNSAP Common Transport Channel Request message. The message includes the D-RNTI and the cell identity previously received in the Uplink Signalling Transfer message, as well as a request for transport layer address and binding identity if there exists no appropriate Iur transport bearer to be used for the UE.
7. The target DRNC sends the transport layer address, binding identity and optionally PHY parameters (FACH code, ...) to the SRNC with the RNSAP Common Transport Channel Response message.
8. If there does not already exist an appropriate Iur transport bearer to be used for the UE, a transport bearer is established from the SRNC.
9. The SRNC sends RRC Cell Update Confirm on DCCH to the UE. The message is sent in the Iur user plane. It will be sent by the target DRNC to the UE on the FACH coupled to the RACH. Subsequent FACH data may be sent on a different FACH if so decided by the target DRNC.
10. FFS in WG2 if needed: UE sends RRC Cell Update Complete on DCCH successful reception of Cell Update Confirm.
11. The SRNC releases the UE context in the source DRNC by sending a Common Transport Channel Release message. The source DRNC releases the D-RNTI.

~~This example shows an Inter RNS cell update in DRNS without SRNS relocation. In this example target RNS, source RNS and serving RNS are all located separately from each other. Other scenarios can be easily derived from this most comprehensive signalling procedure.~~

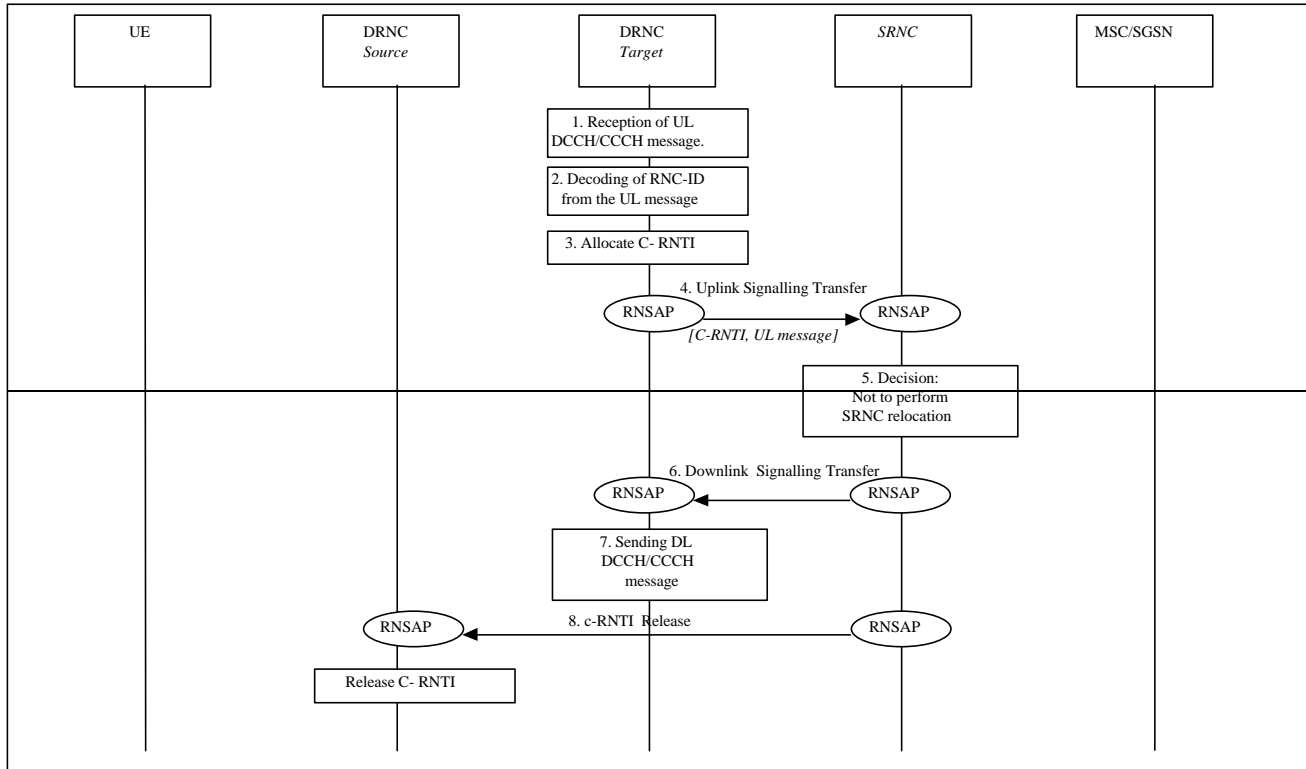

### ~~Cell Update via Iur without SRNS Relocation~~

- ~~1. UE sends a RRC message Cell Update to the UTRAN, after having made cell re-selection.~~

2. Upon reception of a CCCH/DCCH message from a UE, controlling RNC decodes the RNC ID and the S-RNTI.
3. The UE is not registered in the CRNC (RNC ID and SRNTI unknown), thus CRNC allocates C-RNTI for the UE.
4. Controlling RNC forward the received uplink CCCH/DCCH message towards the SRNC by RNSAP UPLINK SIGNALLING TRANSFER message. Message includes also the cell ID of the cell from which the message was received and the allocated C-RNTI.
5. Upon reception of the RNSAP message SRNC decides not to perform a SRNS Relocation towards the target RNC.
6. SRNC replies with the RNSAP DOWNLINK SIGNALLING TRANSFER message containing the DL RRC message to be sent to UE. Message includes also the C-RNTI and the Cell ID indicated in the proceeding CTCH Indication message.
7. The Cell Update Confirm is sent to the UE
8. SRNC send the C-RNTI Release to source RNC. Source RNC releases the C-RNTI.

Note: It is ffs. whether a Cell Update Complete is needed to confirm the successful reception of Cell Update Confirm. The decision is to be made by 3GPP RAN WG2.

### Cell Update via Iur without SRNS relocation (with C-RNTI reallocation)

This example shows a cell update in DRNS without SRNS relocation when an Iur RACH/FACH transport bearer exists and the UE is already known in the DRNS. In this example the DRNC decides to allocate a new C-RNTI for the UE.

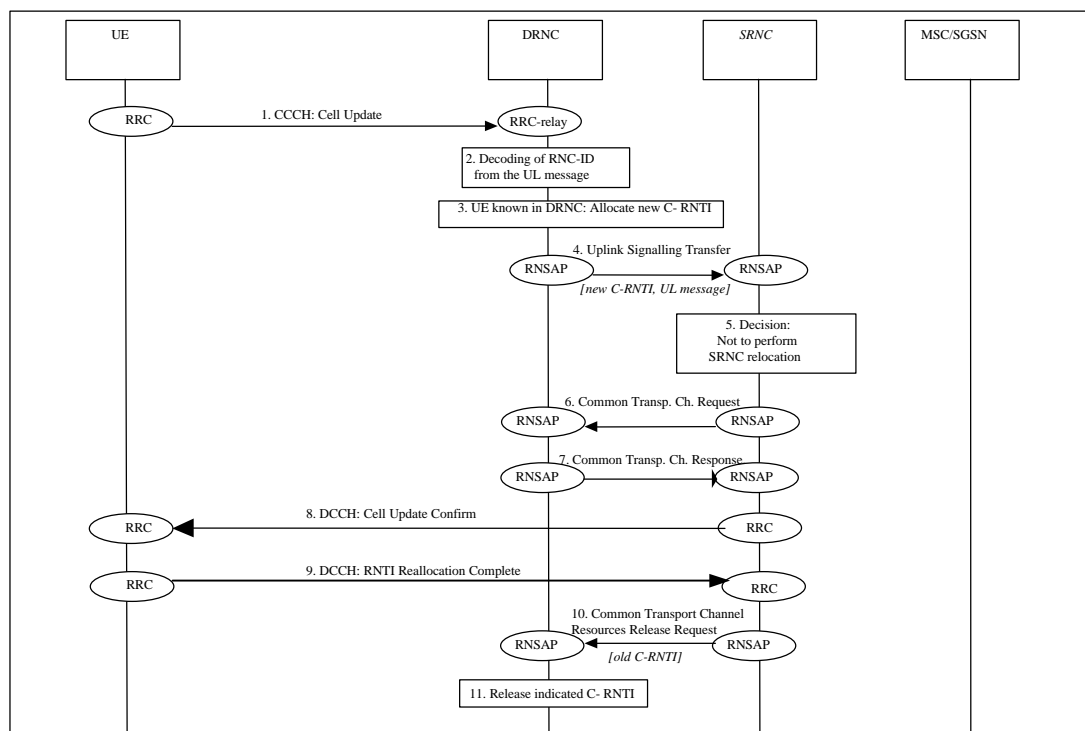

### Cell Update via Iur without SRNS Relocation (with C-RNTI reallocation)

1. UE sends an RRC message Cell Update to the UTRAN, after having made cell re-selection.
2. Upon reception of a CCCH message from a UE, the target DRNC decodes the SRNC ID and the S-RNTI.
3. The UE is already registered in the target DRNC (RNC ID and SRNTI unknown), thus the target DRNC only allocates a new C-RNTI for the UE.
4. The target DRNC forwards the received uplink CCCH message towards the SRNC in the RNSAP Uplink Signalling Transfer message. The Uplink Signalling Transfer message includes also the Cell-ID of the cell from which the CCCH message was received and the new C-RNTI.

5. Upon reception of the Uplink Signalling Transfer message the SRNC decides not to perform a SRNS Relocation towards the target RNC.
6. The SRNC initialises the UE context in the target RNC with the RNSAP Common Transport Channel Request message. The message includes the D-RNTI and the cell identity previously received in the Uplink Signalling Transfer message, as well as a request for transport layer address and binding identity if there exists no appropriate Iur transport bearer to be used for the UE.
7. The target DRNC sends the transport layer address, binding identity and optionally PHY parameters (FACH code, ...) to the SRNC with the RNSAP Common Transport Channel Response message.
8. The SRNC sends RRC Cell Update Confirm on DCCH to the UE. The message is sent in the Iur user plane. It will be sent by the target DRNC to the UE on the FACH coupled to the RACH. Subsequent FACH data may be sent on a different FACH if so decided by the target DRNC.
9. The UE sends RRC RNTI Re-allocation Complete on DCCH successful reception of Cell Update Confirm.
10. The SRNC releases the old C-RNTI in the DRNC by sending a Common Transport Channel Resources Release Request message.
11. The DRNC releases the indicated C-RNTI.

## URA Update

This section presents some examples of URA Update procedures, i.e. those procedures that update the UTRAN registration area of a UE when a RRC connection exists and the position of the UE is known on URA level in the UTRAN.

### 4.1.4 Inter-RNS URA Update with SRNS Relocation

This example shows Inter-RNS URA Update with switching in the CN.

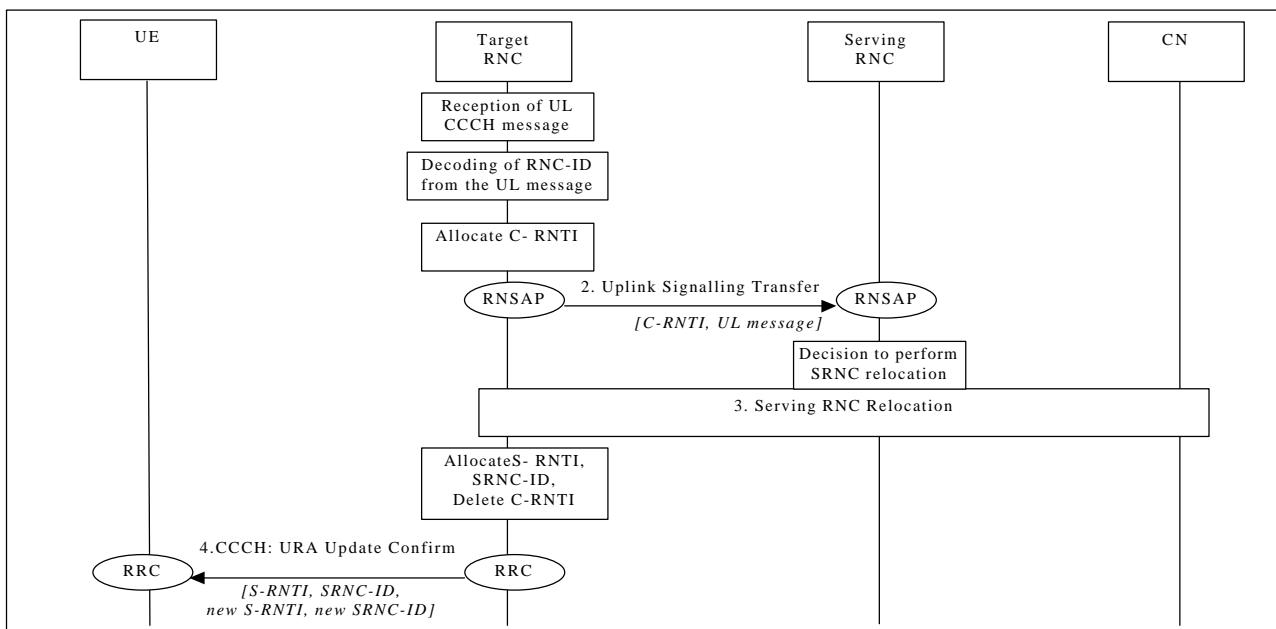

#### Inter RNS URA Update with switching in CN.

1. UE sends a RRC message URA Update to the UTRAN, after having made cell re-selection. Upon reception of a CCCH message from an unknown UE, controlling RNC allocates a new C-RNTI for the UE.
2. Controlling RNC forwards the received uplink CCCH message towards the SRNC by RNSAP by RNSAP UPLINK SIGNALLING TRANSFER message. Message includes also C-RNC includes the allocated C-RNTI,

which is to be used as a UE identification within the C-RNC. Upon reception of the RNSAP message SRNC decides to perform a SRNS Relocation towards the target RNC.

3. Serving RNC relocation procedure is executed as defined in Chapter 'SRNS Relocation (UE connected to a single CN node)'. After having completed SRNS Relocation, target RNC allocates new S-RNTI for the UE. New SRNC also deletes the allocated C-RNTI, since it is not needed for an UE in RACH/PCH state.
4. Serving RNC acknowledges the message by RRC URA Update Confirm, including old S-RNTI and SRNC ID as UE identifiers. Message contains also the new S-RNTI and RNC-ID.

It is ffs. whether a URA Update Complete is needed to confirm the successful reception of URA Update Confirm. The decision is to be made by 3GPP RAN WG2.

#### 4.1.2 Inter-RNS URA Update via Iur without SRNS relocation

This example shows an Inter RNS URA update in DRNS without SRNS relocation. In this example target RNS, source RNS and serving RNS are all located separately from each other. Other scenarios can be easily derived from this most comprehensive signalling procedure.

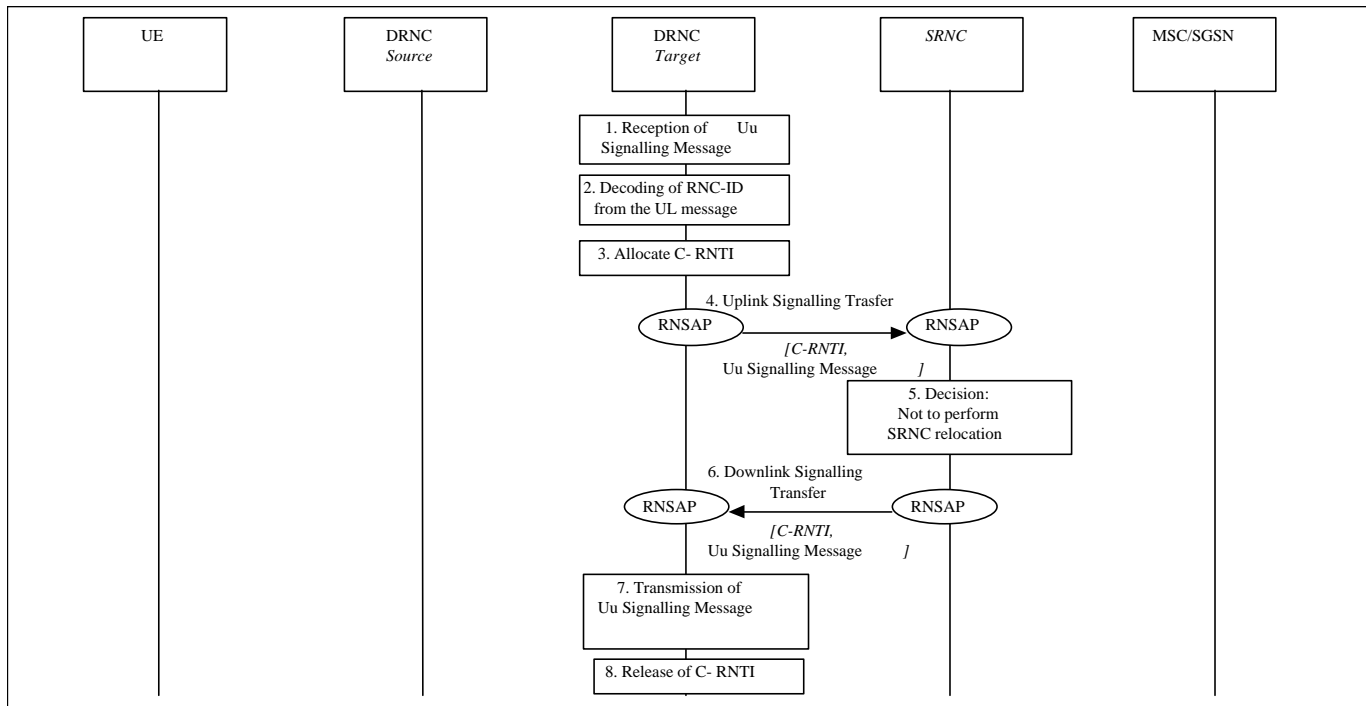

#### Inter-RNS URA Update via Iur without SRNS relocation

1. UE sends a RRC message URA Update to the UTRAN, after having made cell re-selection and URA has changed.
2. Upon reception of the message from a UE, controlling RNC decodes the RNC ID and the S-RNTI.
3. The UE is not registered in the CRNC (RNC ID and SRNTI unknown), thus CRNC allocates C-RNTI for the UE.
4. Controlling RNC forward the received Uu signalling message towards the SRNC by RNSAP UPLINK SIGNALLING TRANSFER message. Messages includes also the cell-ID from which the message was received and the allocated C-RNTI.

5. Upon reception of the RNSAP message SRNC decides not to perform a SRNS relocation towards the target RNC.
6. SRNC replies with the RNSAP DOWNLINK SIGNALLING TRANSFER message containing the DL Uu signalling message to be sent to UE. Message includes also the C-RNTI and the Cell-ID indicated in the preceding UPLINK SIGNALLING TRANSFER message.
7. The URA Update Confirm is sent to the UE
8. DRNC releases the allocated C-RNTI.

#### 4.1.3 SRNS Relocation (UE connected to two CN nodes)

This example shows SRNS Relocation, in situation in which the UE is connected to two CN nodes simultaneously. It is assumed that:

- all cells in the active set are in one DRNC;
- the CN performs hard switching of the user traffic.

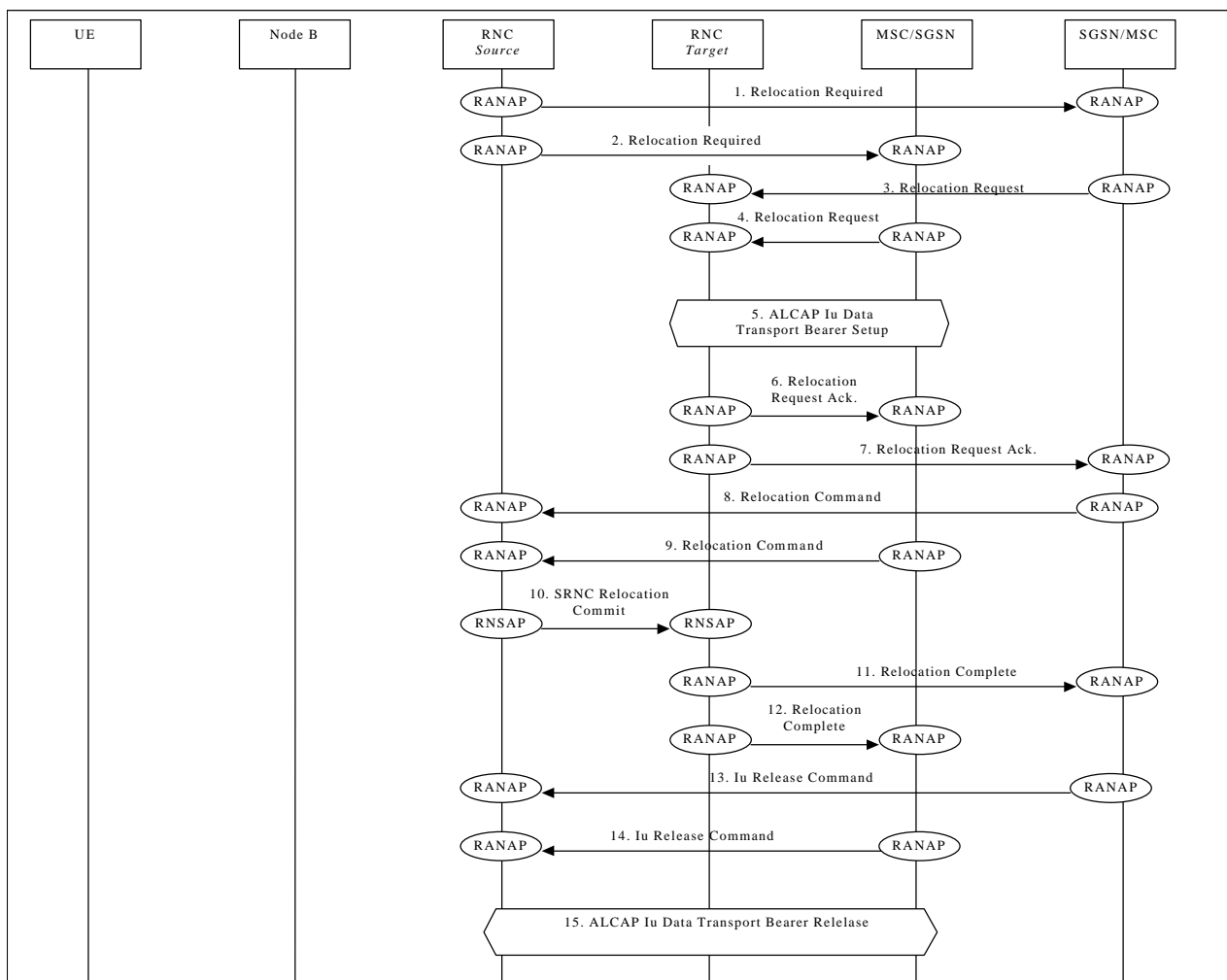

**SRNS Relocation (UE connected to two CN nodes)**

Note that the SRNC makes the decision to perform the Serving RNC relocation procedure. The Serving RNC also decides into which RNC (Target RNC) the Serving RNC functionality is to be relocated.

- 1./2. The source SRNC sends **Relocation Required** messages to both CN nodes.  
  
Parameters: target RNC identifier, Information field that the CN node(s) shall pass transparently to the target RNC. This transparent field contains the UE identifier, number of CN nodes and other TBD data.  
Upon reception of **Relocation Required** message the CN element prepares itself for the switch and may also suspend user data traffic and/or signalling between UE and itself for some bearers.
- 3./4. When preparation is completed the CN node conveys a **Relocation Request** message to the target RNC.  
  
Parameters: indication of which bearers should be routed towards this CN node, transparent information field sent by the source RNC, UE identifier.  
  
The target RNC uses the UE identifier to link the requests from multiple CN nodes to each other and to the resources (e.g. Iub links) that the UE is currently using.  
FFS: The target RNC allocates necessary Iur branches to be used after the SRNS Relocation switch will be made.
5. The target RNC and CN node establish the new Iu transport bearers for each Radio Access Bearer related to that CN node.
- 6./7. When the source RNC and the target RNC have completed its preparation phase, **Relocation Request Acknowledge** message is sent to CN.
- 8./9. When the CN node is ready for the SRNC move, the CN node indicates the completion of preparation phase at the CN side for the SRNS Relocation by sending the **Relocation Command** message. To the source RNC and the target RNC.
10. When the source RNC has received **Relocation Command** messages from all the CN nodes, the source RNC sends a **Relocation Commit** message to the target RNC. The target RNC executes both the DL and UL switch for all bearers at the earliest suitable time instance.  
After the switch UL traffic from node-B's is routed via the newly established Macro Diversity Combiner to the new MAC/RLC entities and finally to the correct Iu transport bearer. UL data transmission to the old Iur transport bearer is ceased.  
DL data arriving from the new Iu link is routed to newly established RLC entities, to the MAC and to the Macro Diversity Splitter and Nodes B. The DL data received from the old Iur is discarded.
- 11./12. Immediately after a successful switch at RNC, target RNC (=SRNC) sends **Relocation Complete** messages to the involved CN nodes.  
  
Upon reception of messages 9 and 10, the CN switches from the old Iu transport bearers to the new ones.
- 13./14. After a successful switch at the CN node, the CN node initiates the release of the Iu connection to the source RNC by sending the RANAP message **Iu Release Command**.
15. Upon reception of the release requests from the CN nodes the old SRNC executes all necessary procedures to release all visible UTRAN resources that were related to the RRC connection in question.

At any phase, before the **SRNS Relocation Complete** message is sent, the old communication link between the CN and UE is all the time existing and working and the procedure execution can be stopped and original configuration easily restored. If any such abnormal thing occurs a **SRNS Relocation Failure** may be sent instead of any message numbered 3-11 described.

## HO between UTRAN and GSM/BSS

This section presents some examples of handover procedure from UTRAN to GSM/BSS and vice versa.

The case of a UTRAN connected to UMTS CN connected to a 2G-MSC (i.e. via MAP/E interface) is shown, while the case of an UTRAN connected to a GSM CN through an IWF (where RANAP is interworked with BSSMAP) is not shown because is equivalent from the point of view of the UTRAN.

The case of HO between UTRAN and GPRS and viceversa are also considered.

4.

## UTRAN ⇒ GSM/BSS

This example shows how handover (Hard Handover) is performed from UTRAN to GSM/BSS between a UMTS CN and a 2G-MSC.

Note: Procedures between CN and MSC, and between MSC and BSC are out of the scope of WG3, and are only included for clarity.

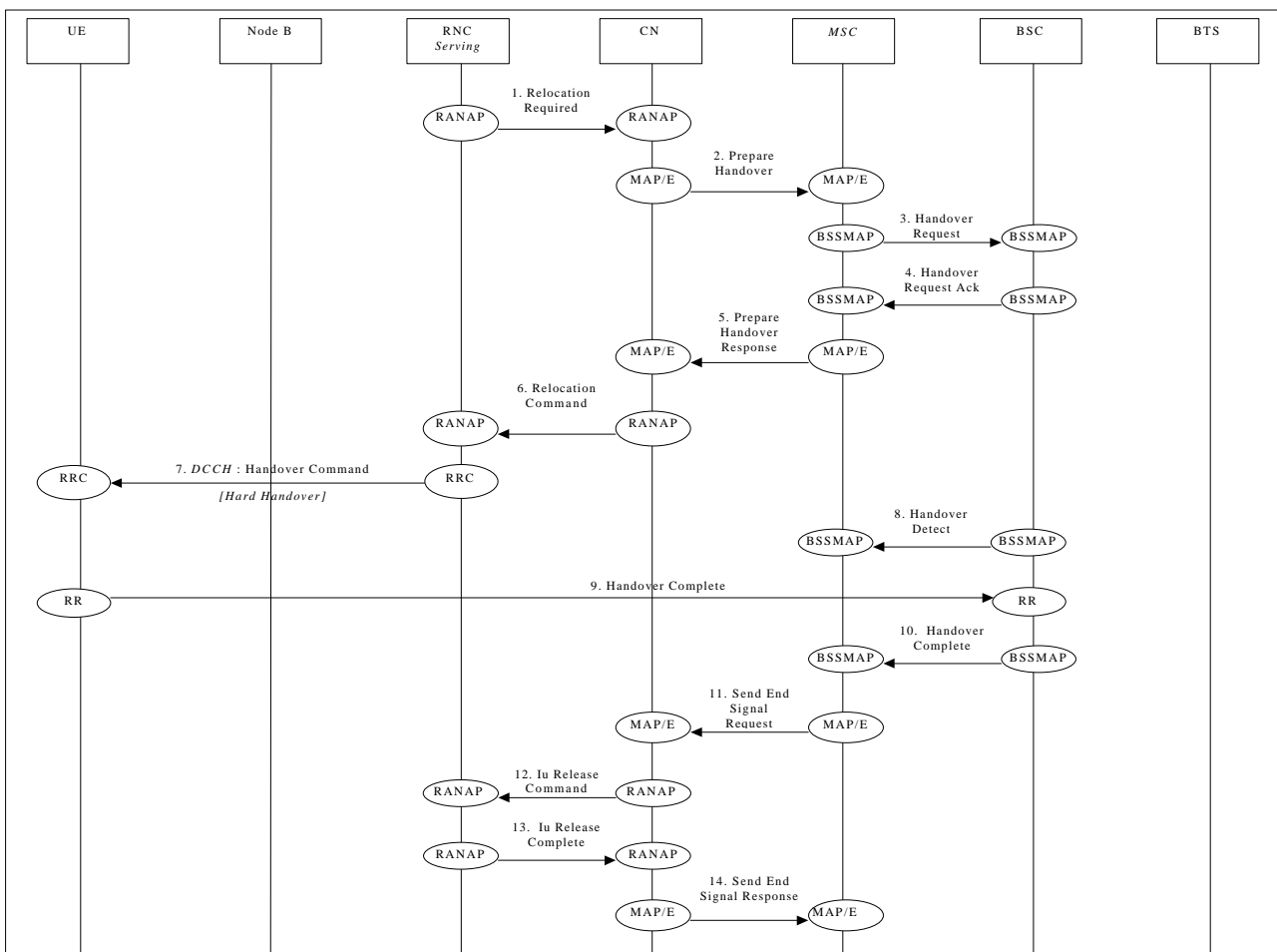

### UTRAN ⇒ GSM/BSS handover

1. Upon detection of a trigger SRNC sends RANAP message **Relocation Required** to the CN.
2. The UMTS CN will forward this request to the GSM MSC (indicated in the received message) over the MAP/E interface (MAP message **Prepare Handover**).

Note: Steps 3&4 follow the normal GSM procedures and are shown only for clarity.

5. Once initial procedures are complete in GSM MSC/BSS the MSC returns MAP/E message **Prepare Handover**.



6. CN responds to the initial request from SRNC by sending RANAP message **Relocation Command** to the SRNC.
7. Via existing RRC connection, SRNC sends RRC message **Handover Command** (Hard Handover) to the UE.  
Parameters: Handover type.

Note: Procedures related to synchronisation etc. to GSM BSS are not shown.

Note: Step 8&10 follow normal GSM procedures and are shown only for clarity.

11. Detection of the UE within the GSM coverage results in the MSC sending MAP/E message **Send End Signal Request** to the CN.
12. CN initiates release of resources allocated by the former SRNC (**Iu Release Command**).
13. Previously allocated bearer resources are released within UMTS (e.g. using RANAP and ALCAP protocols [ALCAP not shown]) (**Iu Release Complete**).
14. Procedure is concluded from UMTS point of view by CN sending MAP/E message **Send End Signal Response** (this message is not sent until the end of the call).

#### 4.1.2 GSM/BSS ⇒ UTRAN

This example shows how handover (Hard Handover) is performed from GSM/BSS to UMTS between a UMTS CN and a 2G-MSC.

Note: Procedures between CN and MSC, and between MSC and BSC are out of the scope of WG3, and are only included for clarity.

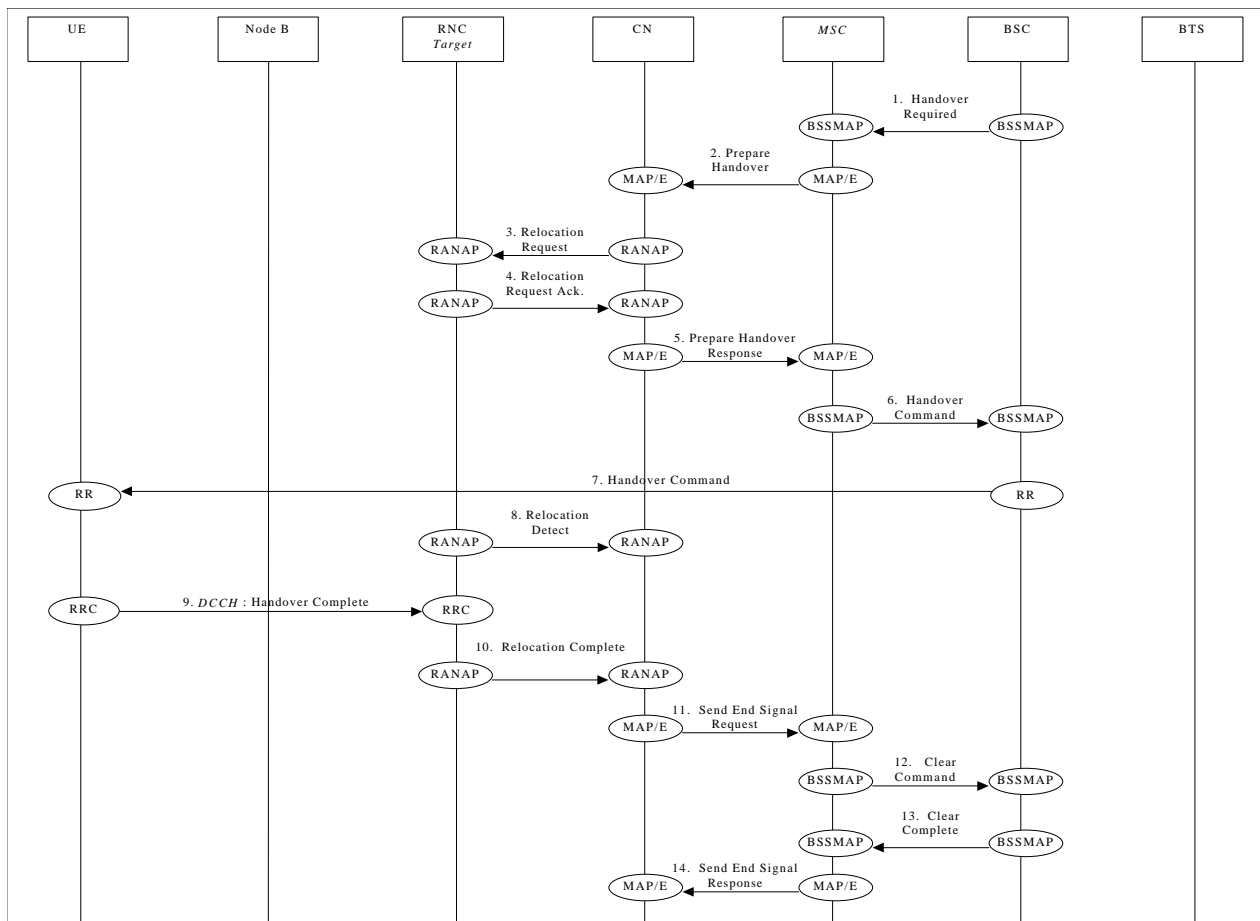

### GSM/BSS ⇒ UTRAN handover

1. The BSC sends **Handover Required** message to the GSM MSC.
2. The MSC sends MAP/E message **Prepare Handover** to the UMTS CN.
3. The CN sends RANAP message **Relocation Request** to the Target RNC.
4. Response **Relocation Request Acknowledge** is returned to the CN by the target RNC via RANAP.
5. MAP/E message **Prepare Handover Response** is sent by the UMTS CN to the MSC.

Note: Step 6&7 follow normal GSM procedures and are shown only for clarity.

8. When target RNC has detected the UE, **RelocationDetect** message is sent to the CN node.
9. When the RRC connection is established with the target RNC and necessary radio resources have been allocated the UE sends RRC message **Handover complete** to the target RNC.
10. Once complete the target RNC sends RANAP message **Relocation Complete** to the CN.
11. CN sends MAP/E message **Send End Signal Request** to the MSC.
12. The MSC sends **Clear Command** message to the BSC.
13. The BSC responds with **Clear Complete** message to the GSM
15. The MSC sends MAP/E message **Send End Signal Response** to the UMTS CN to conclude the procedure (this message is not sent until the end of the call).

Note: The possibility to perform handover from GSM/BSS=>UMTS going directly in macrodiversity state (i.e.establishing directly multiple macrodiversity paths) is FFS

### 4.1.3 GPRS ⇒ UTRAN

This section shows UTRAN signalling procedures for GPRS to UTRAN handover.

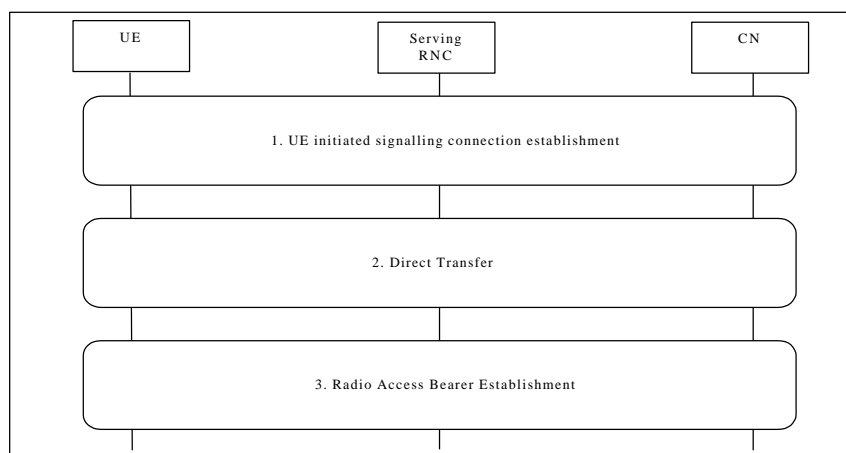

1. The UE selects a UTRAN cell, reads system information, and initiates establishment of a NAS signalling connection.  
See section UE Initiated Signalling Connection Establishment.
2. The NAS signalling connection between UE and CN can now be used for NAS message transfer (e.g. execution of security functions).  
See section Direct Transfer.
3. After necessary CN-GPRS preparations (e.g. UE context information retrieval), CN initiates establishment of RAB(s).  
See section Radio Access Bearer Establishment.

### UTRAN ⇒ GPRS, UE Initiated

This section shows UTRAN signalling procedures for UTRAN to GPRS handover initiated by UE cell reselection.

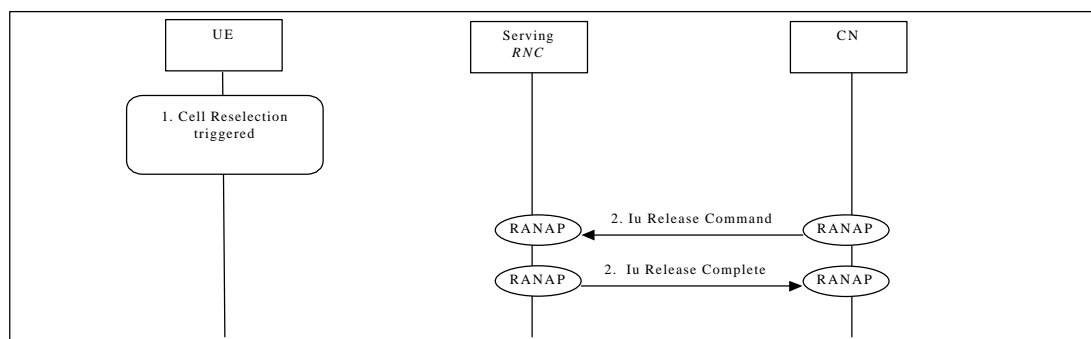

1. The UE selects a GPRS cell, reads system information, and initiates establishment of UE-GPRS connection.
2. After necessary CN-GPRS preparations (e.g. UE context information retrieval), CN initiates release of Iu connection. SRNC releases the RRC connection.

## UTRAN ⇒ GPRS, Network Initiated

This section shows UTRAN signalling procedures for UTRAN to GPRS handover triggered by Serving RNC.

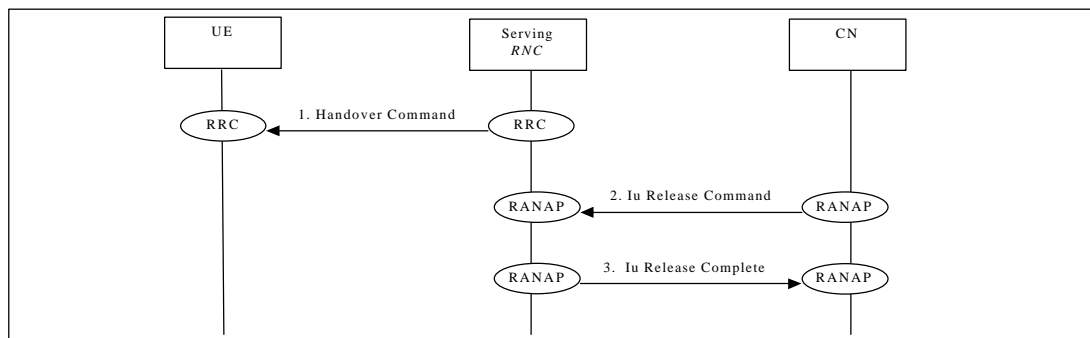

1. Based on UE measurements, SRNC triggers the handover to a GPRS cell by sending a Handover Command to the UE. UE initiates establishment of UE-GPRS connection.
2. After necessary CN-GPRS preparations (e.g. UE context information retrieval), CN initiates release of the RRC connection.
3. SRNC releases all resources reserved for the UE.

## Load Indication

This section shows examples of load indication reporting.

## Ciphering

This example shows ciphering procedure.

## Transport CH Reconfiguration

### Transport CH Reconfiguration (Dedicated CH to Dedicated CH)

#### Synchronised Transport Channel Reconfiguration

The procedure can be applied when the reconfiguration time requires being synchronised among Node-Bs, SRNC and UE.

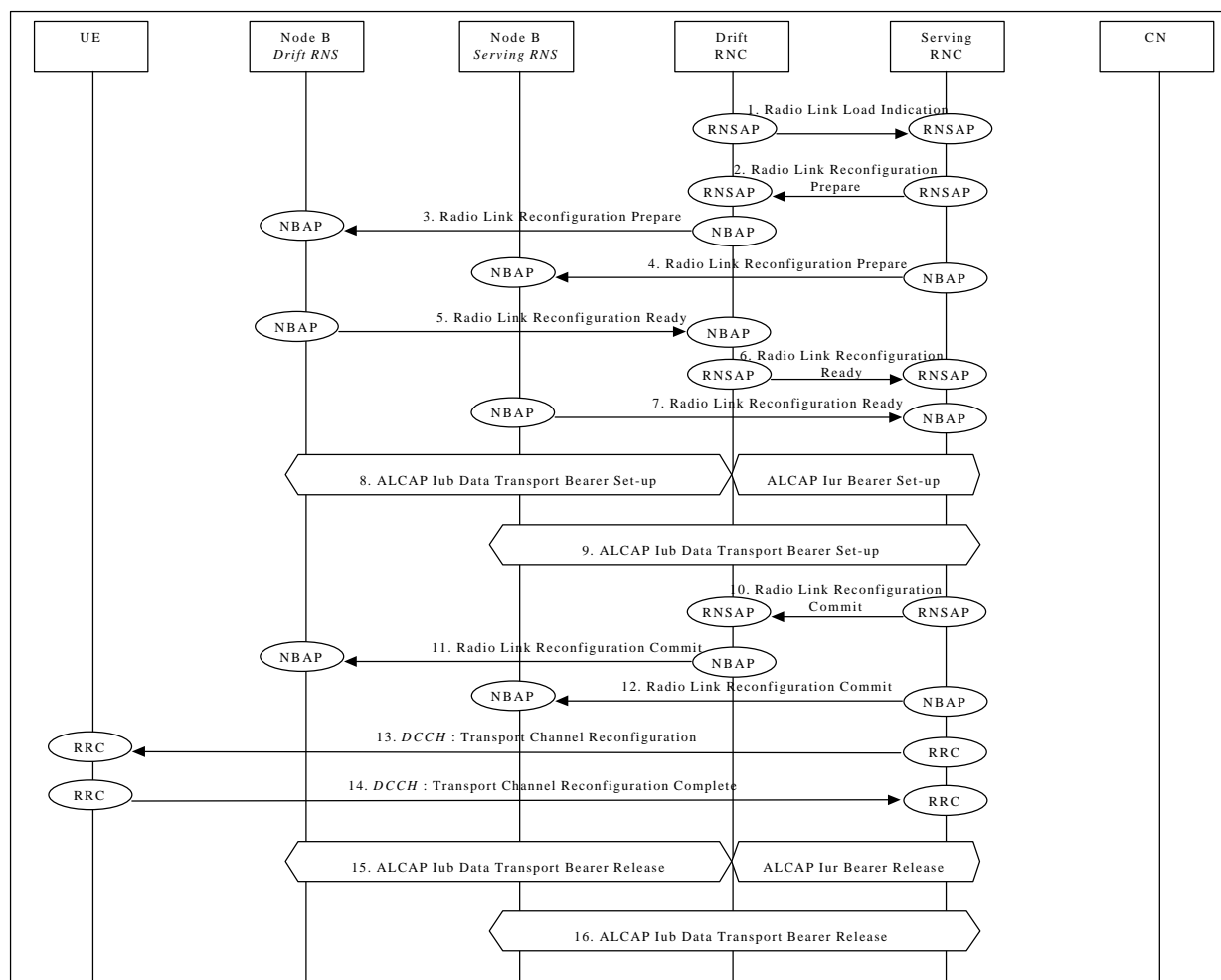

#### Synchronised Transport Channel Reconfiguration

2. DRNC detects the need for a Transport Channel Reconfiguration and sends the RNSAP message **Radio Link Load Indication** to the SRNC. This message is optional.
2. SRNC decided that there is a need for a synchronous Transport Channel Reconfiguration and requests DRNC to prepare reconfiguration of DCH **Radio Link Reconfiguration Prepare**.

Parameters: Transport Format Set, Transport Format Combination Set, Power control information, DL channelisation code (FDD only), Time Slots (TDD only), User Codes (TDD only).

3. DRNC requests its Node B to prepare reconfiguration of DCH to carry the RAB (**Radio Link Reconfiguration Prepare**).  
Parameters: Transport Format Set, Transport Format Combination Set, Power control information, DL channelisation code (FDD only), Time Slots (TDD only), User Codes (TDD only).

4. SRNC requests its Node B to prepare reconfiguration of DCH (**Radio Link Reconfiguration Prepare**).  
Parameters: Transport Format Set, Transport Format Combination Set, Power control information, DL channelisation code (FDD only), Time Slots (TDD only), User Codes (TDD only).
5. Node B allocates resources and notifies DRNC that the reconfiguration is ready (**Radio Link Reconfiguration Ready**).  
Parameters: Transport layer addressing information (AAL2 address, AAL2 Binding Id) for Iub Data Transport Bearer.
6. DRNC notifies SRNC that the reconfiguration is ready (**Radio Link Reconfiguration Ready**).  
Parameters: Transport layer addressing information (AAL2 address, AAL2 Binding Id) for Iur Data Transport Bearer.
7. Node B allocates resources and notifies SRNC that the reconfiguration is ready (**Radio Link Reconfiguration Ready**).  
Parameters: DL channelisation code Per Cell (FDD only), Transport layer addressing information (AAL2 address, AAL2 Binding Id) for Iub Data Transport Bearer.
8. SRNC initiates (if needed) establishment of new Iur/Iub Data Transport Bearers using ALCAP protocol. This request contains the AAL2 Binding Identity to bind the Iur/Iub Data Transport Bearer to DCH.
9. SRNC initiates (if needed) establishment of new Iub Data Transport Bearers using ALCAP protocol. This request contains the AAL2 Binding Identity to bind the Iub Data Transport Bearer to DCH.
10. RNSAP message **Radio Link Reconfiguration Commit** is sent from SRNC to DRNC.  
Parameters: CFN.
11. NBAP message **Radio Link Reconfiguration Commit** is sent from DRNC to Node B.  
Parameters: CFN.
12. NBAP message **Radio Link Reconfiguration Commit** is sent from SRNC to Node B.  
Parameters: CFN.
13. RRC message **Transport Channel Reconfiguration** is sent by SRNC to UE.
14. UE sends RRC message **Transport Channel Reconfiguration Complete** to SRNC.
15. Not used resources in-DRNC and NodeB (Drift RNS) are released. DRNC initiates release of Iur and Iub (Drift RNS) Data Transport bearer using ALCAP protocol.
16. Not used resources in SRNC and NodeB (Serving RNS) are released. SRNC initiates release of Iub (Serving RNS) Data Transport bearer using ALCAP protocol.

### Unsynchronised Transport Channel Reconfiguration

The procedure can be applied when the reconfiguration time does not require being synchronised among Node-Bs, SRNC and UE.

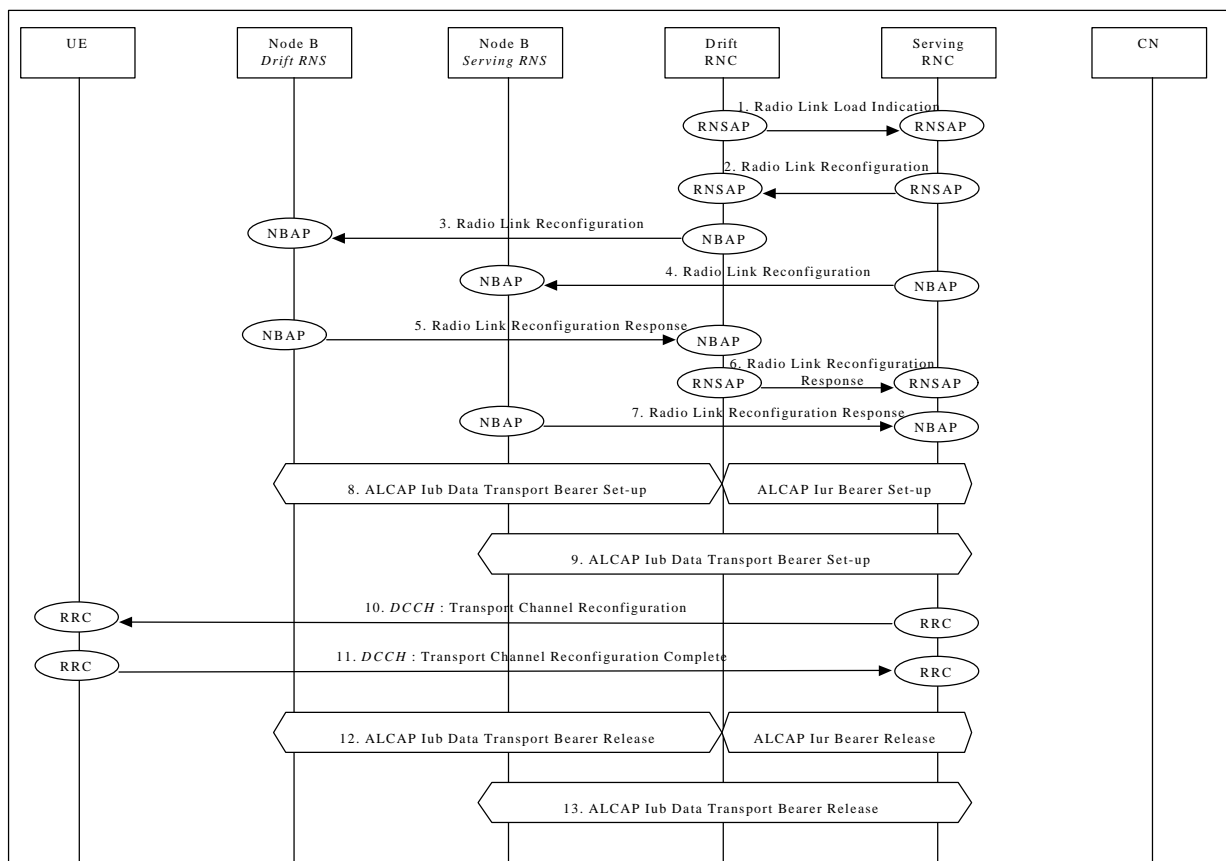

### Unsyncronised Transport Channel Reconfiguration

3. DRNC detects the need for a Transport Channel Reconfiguration and sends the RNSAP message **Radio Link Load Indication** to the SRNC. This message is optional.
18. SRNC decided that there are no need for a synchronised Transport Channel Reconfiguration, and requests DRNC to reconfigure the DCH. It includes in the message **Radio Link Reconfiguration** that the modification shall be done immediately without waiting for the commit message.  
Parameters: Transport Format Set, Transport Format Combination Set, Power control information, DL channelisation code (FDD only), Time Slots (TDD only), User Codes (TDD only).
19. DRNC requests its Node B to reconfigure the DCH in the existing Radio Link (**Radio Link Reconfiguration**).  
Parameters: Transport Format Set, Transport Format Combination Set, Power control information, DL channelisation code (FDD only), Time Slots (TDD only), User Codes (TDD only).
20. SRNC requests its Node B to reconfigure the DCH in the existing Radio Link (**Radio Link Reconfiguration**).  
Parameters: Transport Format Set, Transport Format Combination Set, Power control information, DL channelisation code (FDD only), Time Slots (TDD only), User Codes (TDD only).
21. Node B of the DRNC allocates resources and notifies DRNC that the reconfiguration is done (**Radio Link Reconfiguration Response**).  
Parameters: Transport layer addressing information (AAL2 address, AAL2 Binding Id) for Iub Data Transport Bearer.
22. DRNC notifies SRNC that the reconfiguration is done (**Radio Link Reconfiguration Response**).  
Parameters: Transport layer addressing information (AAL2 address, AAL2 Binding Id) for Iur Data Transport Bearer.
23. Node B of the SRNC allocates resources and notifies DRNC that the reconfiguration is done (**Radio Link Reconfiguration Response**).  
Parameters: Transport layer addressing information (AAL2 address, AAL2 Binding Id) for Iub Data Transport Bearer.

24. SRNC initiates (if needed) establishment of new Iur/Iub Data Transport Bearers using ALCAP protocol. This request contains the AAL2 Binding Identity to bind the Iur/Iub Data Transport Bearer to DCH.
25. SRNC initiates (if needed) establishment of new Iub Data Transport Bearers using ALCAP protocol. This request contains the AAL2 Binding Identity to bind the Iub Data Transport Bearer to DCH.
26. RRC message **Transport Channel Reconfiguration** is sent by SRNC to UE.
27. UE sends RRC message **Transport Channel Reconfiguration Complete** to SRNC.
28. Not used resources in-DRNC and NodeB (Drift RNS) are released. DRNC initiates release of Iur and Iub (Drift RNS) Data Transport bearer using ALCAP protocol
29. Not used resources in SRNC and NodeB (Serving RNS) are released. SRNC initiates release of Iub (Serving RNS) Data Transport bearer using ALCAP protocol.

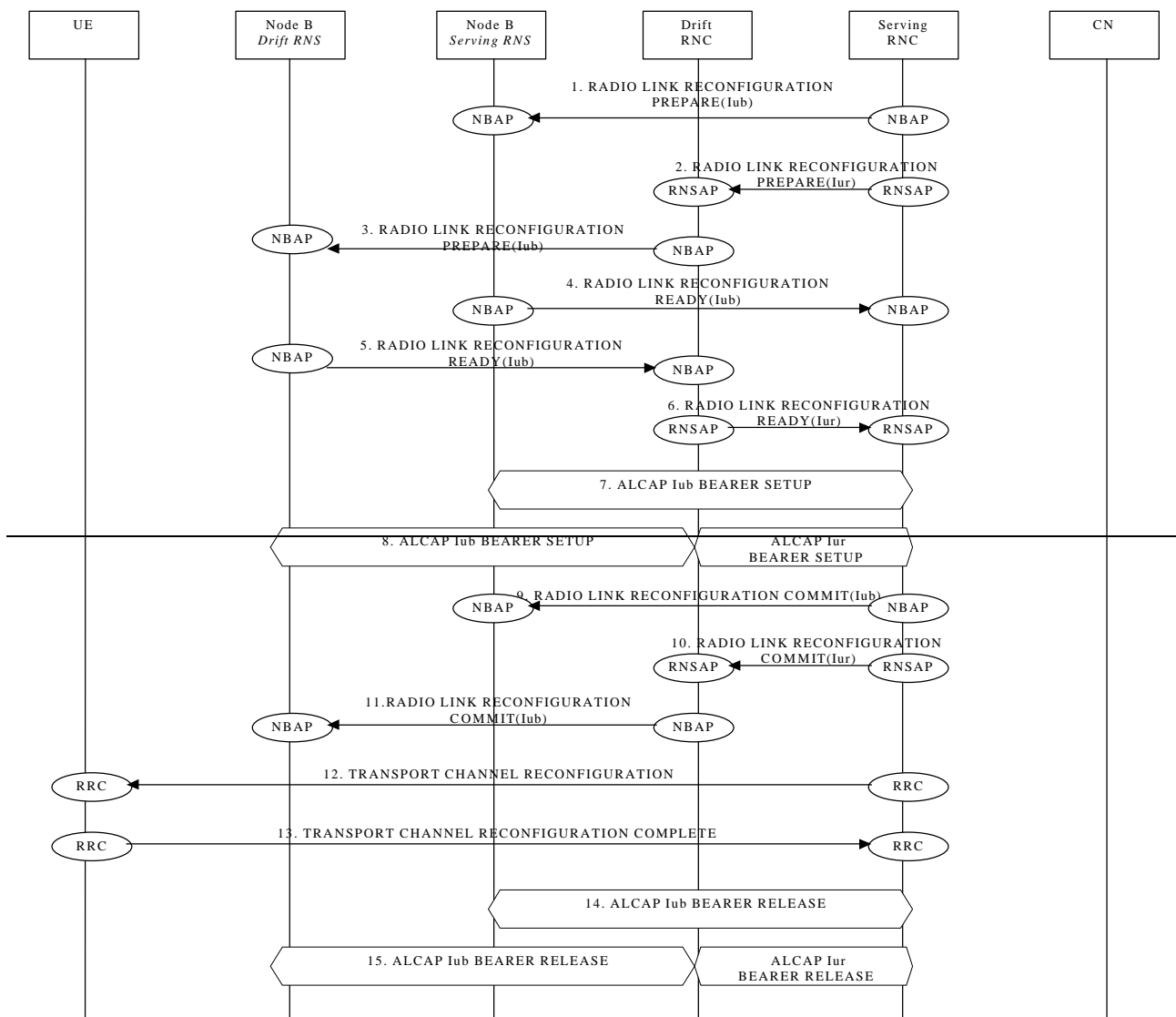



#### 4.1.2 Transport CH Reconfiguration (RACH/FACH to RACH/FACH)

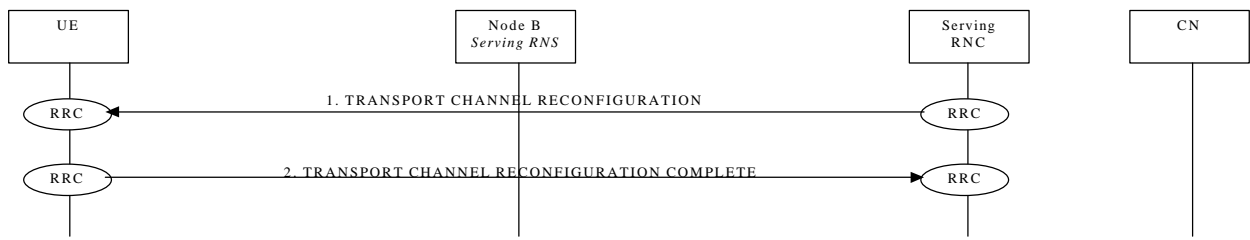

Note : this procedure is FFS

### 4.1.3 Transport CH Reconfiguration (RACH/FACH to Dedicated CH)

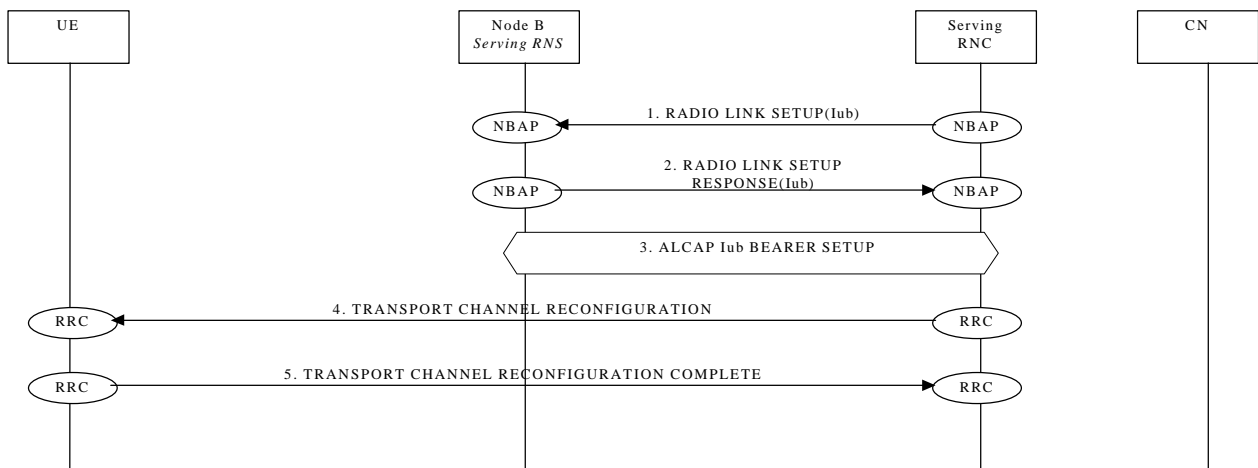

#### 4.1.4 Transport CH Reconfiguration (Dedicated CH to RACH/FACH)

Note: this example shows the case of Transport CH Reconfiguration (Dedicated CH to RACH/FACH) combined with a SRNS relocation.

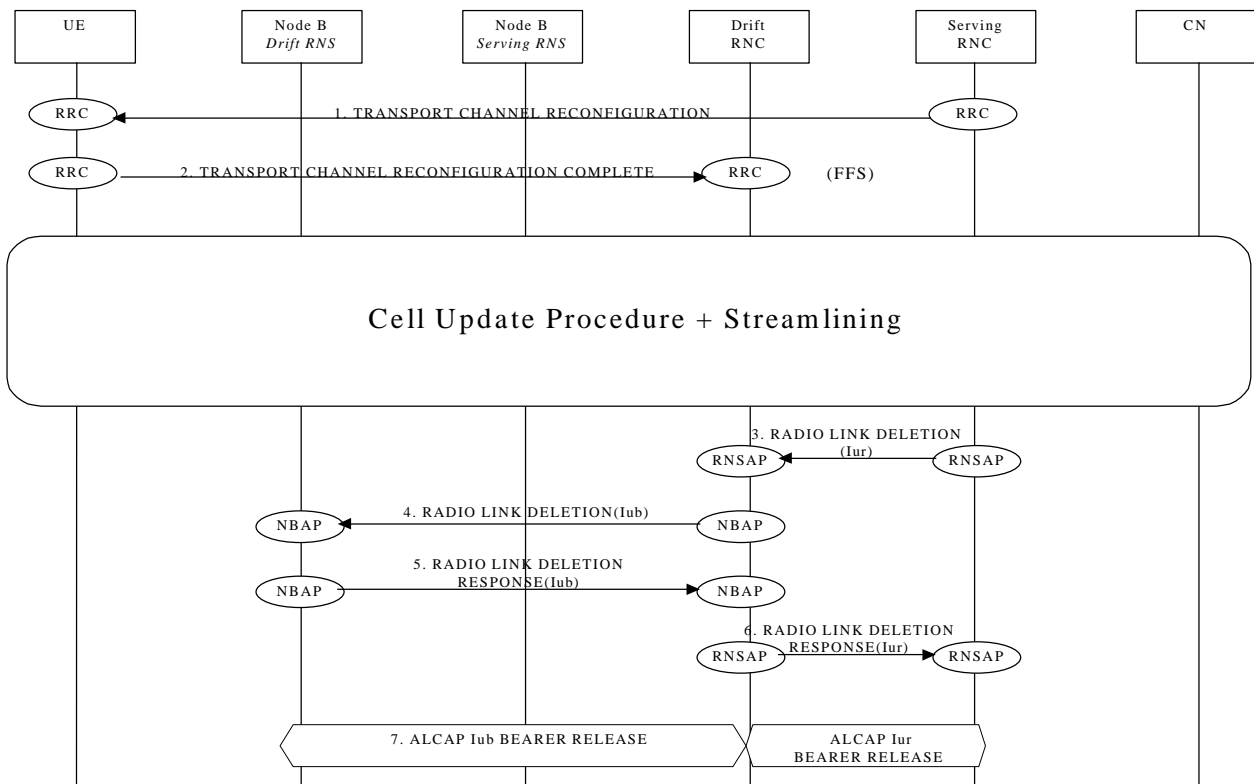

# Notification

NOTE: The whole procedure is FFS.

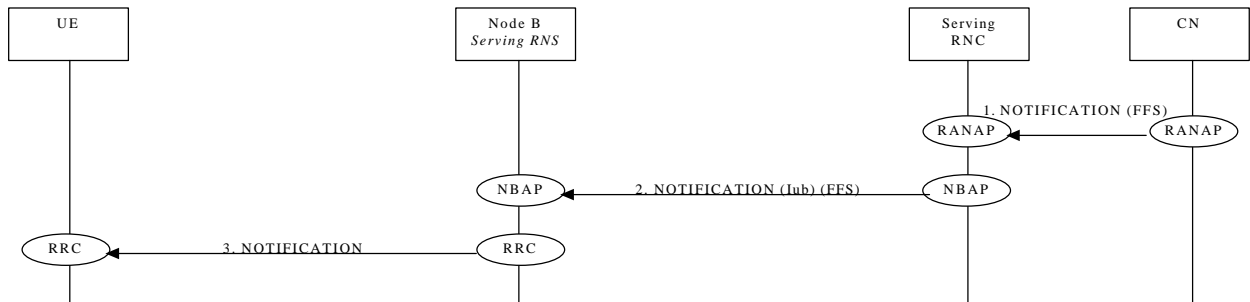

# DL Code Reconfiguration

NOTE: The whole procedure is FFS.

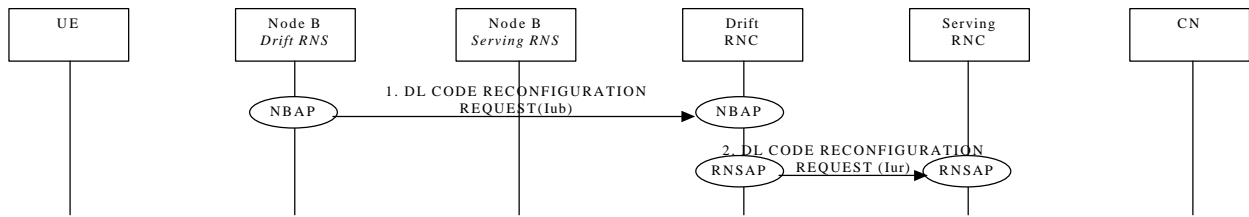

## Direct Transfer

### Uplink Direct Transfer

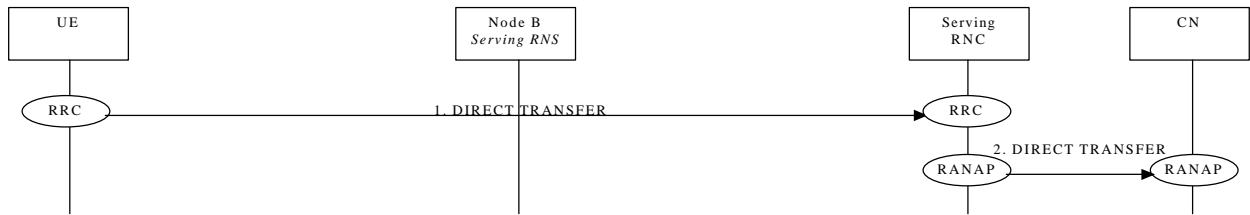

## Downlink Direct Transfer

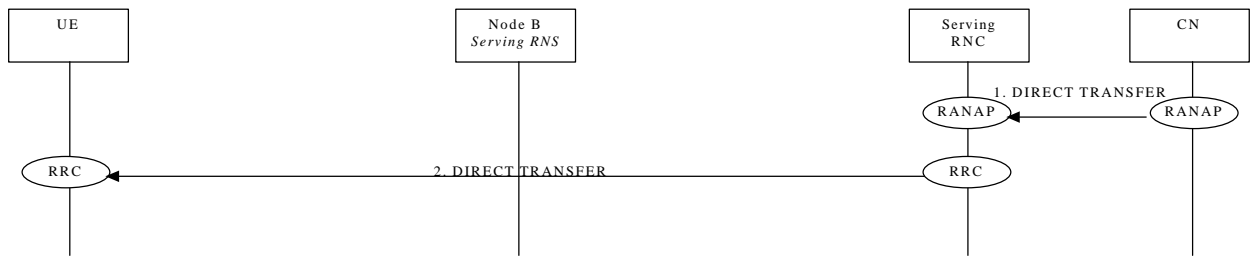

## 9.22 Downlink Power Control

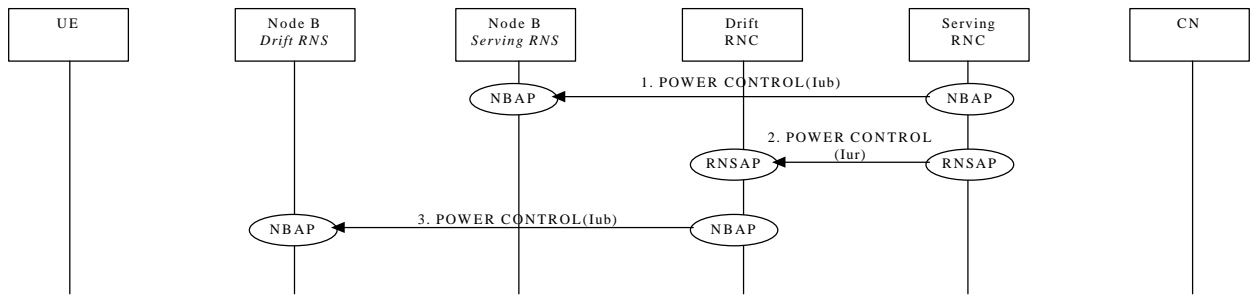



<b>Document history</b>		
<b>Date</b>	<b>Version</b>	<b>Comment</b>
<u>5 September 1999</u>	<u>1.2.1</u>	<p>The revision marks are reflecting the changes decided at the Sophia meeting (August 99) in addition to the one agreed at Helsinki meeting (July 99):</p> <ul style="list-style-type: none"> <li>• <u>New section 9.13.2.3 Cell Update via Iur without SRNS relocation (with C-RNTI reallocation) was added.</u></li> </ul>
<u>3 August 1999</u>	<u>1.2.0</u>	<p>Revisions accepted respect to version version 1.1.2</p> <p>Some strictly editorial updates are not shown as revision marks (style alignment, inclusion of pictures in frames, etc)</p> <p>The revision marks are reflecting the additional changes decided at the Helsinki meeting (July 99):</p> <ul style="list-style-type: none"> <li>• <u>The section 9.5.1 was renumbered 9.5.1.1</u> <u>A new section 9.5.1.2 RRC Connection Re-establishment with SRNC Relocation - DCH Re-establishment was added based on update contribution 696</u></li> <li>• <u>Content for new section 9.10.1 Physical Channel Reconfiguration (DCH) was included based on update contribution 692</u></li> <li>• <u>Content for new section 9.10.2 Reconfiguration (CRNC Controlled) was included based on updated contribution 693</u></li> <li>• <u>9.13.2.2 Cell Update via Iur without SRNS relocation was updated based on updated contribution 734</u></li> <li>• <u>The procedure shown in section 9.18.1 was updated and moved in new subsection 9.18.1.1 Synchronised Transport Channel Reconfiguration based on update contribution 694</u></li> <li>• <u>New section 9.18.1.2 Unsynchronised Transport Channel Reconfiguration was included based on update contribution 695</u></li> </ul>
<u>22 June 1999</u>	<u>1.1.2</u>	<u>same as 1.1.1, version presented at the Helsinki meeting (July 99)</u>
<u>13 June 1999</u>	<u>1.1.1</u>	<u>the same as 1.1.0, version presented at TSG RAN</u>
<u>2 June 1999</u>	<u>1.1.0</u>	<p>revisions accepted respect to version version 1.0.2</p> <p>The revision marks are reflecting the additional changes decided at the Warwick meeting</p>

30 May 1999	1.0.2	<p>This version presents some editorial updated and some proposals to cope with the decision taken at the last meeting (kawasaki, April 99).</p> <p>Major changes are derscribed in the following list:</p> <ul style="list-style-type: none"><li>• Updated figure for the protocol stack section 6.1</li><li>• Updated message list for section 6.2</li><li>• Modified figure and text in sections in order to allign it to the RANAP unified HO and SRNS relocation procedures agreedeed at the Kawasaki meeting (april 99)<ul style="list-style-type: none"><li>9.13.1.3 Hard HO with switching in the CN</li><li>9.14.3 SRNS Relocation</li><li>9.15.1 UTRAN =&gt; GSM/BSS HO</li><li>9.15.2 GSM/BSS =&gt; UTRAN HO</li></ul></li></ul>
-------------	-------	---------------------------------------------------------------------------------------------------------------------------------------------------------------------------------------------------------------------------------------------------------------------------------------------------------------------------------------------------------------------------------------------------------------------------------------------------------------------------------------------------------------------------------------------------------------------------------------------------------------------------------------------------------------------------------------------------------------------------------------------

24 May 1999	1.0.1	<p>This version includes the modification agreed at the TSG-RAN WG3 #3 in Kawasaki (Apr 99).</p> <p>The following three changes are not introduced, they will be presented as editor proposals:</p> <ul style="list-style-type: none"> <li>• A new section for Q.AAL example into a new section 6.4.</li> <li>• A new figure in the protocol stack section 6.1</li> <li>• The name of the messages for HO should be modified in order to cope with the unified procedures decided at the last meeting</li> </ul> <p>Major introduced changes are listed below (number referred to old numbering)</p> <ul style="list-style-type: none"> <li>• Q.aal2 flows were removed and the ALCAP boxes were put again in scenario 9.4.1</li> <li>• Section 6.6 and 6.7 were removed due to the fact that these sections are only related to WG2 issues.</li> <li>• Common channel and CCH were replaced with common transport channel and FACH/RACH</li> <li>• The term SRNC Relocation was replaced SRNS Relocation</li> <li>• Section 9.3.2 and 9.11.2 were replaced by a reference to the proper WG2 documents, due to the fact that these sections are only related to WG2 issues (Correct reference to be filled)</li> <li>• The section 9.13 was restructured and renamed (backward HO) and merged with 9.14 (cell update is forward HO).</li> <li>• Section 9.14.2 was replaced with the content of Tdoc 355 from Nokia, updated accordingly with the modification decided at the meeting</li> <li>• Section 9.17 was restructured and new section for HO between UMTS and GPRS were introduced</li> <li>• Section 9.25 was removed (inband mechanism, example not needed)</li> <li>• A temporary annex was added to summarize the status of the recommendation.</li> </ul>
April 99	1.0.0	Agreed at TSG RAN April 99 and promoted to version 1.0.0 (the same as 0.1.0)
April 16 <sup>th</sup> 1999	0.1.0	<p>Same as version 0.0.5, revision marks accepted</p> <p>This version was sent to TSG RAN April 1999 meeting for approval</p>

April 16 <sup>th</sup> 1999	0.0.5	<p>This version contains mainly editorial enhancements. Major changes are listed below</p> <ul style="list-style-type: none"> <li>• Section 6.1 SRNC Relocation Commit message was added</li> <li>• Section 9.17.2 Release Complete message was added</li> <li>• Section 9.2.1 Link Establishment and Link Establishment Acknowledge messages were added</li> </ul>
April 6 <sup>th</sup> 1999	0.0.4	<p>This version contains mainly editorial enhancements. Major changes are listed below:</p> <ul style="list-style-type: none"> <li>• section 7.1 and 7.2 were promoted to section 8 and 9 in order to limit the deep in the subsection numbering; subsection were promoted accordingly</li> <li>• Figure numberig was incomplete and also produces unclear revision marks due to a bug of word; Only the numbering of the first figures was left</li> <li>• Styles were aligned to make the document consistant</li> <li>• Hard Handover Proceeding 2 message was removed for alignment with RNSAP procedures (section 9.17.4)</li> </ul>
April 6 <sup>th</sup> 1999	0.0.3	<p>This version includes also the modification agreed at the TSG-RAN WG3 march 1999 meeting. Major changes summary follows:</p> <ul style="list-style-type: none"> <li>• section 7.2.13.2.1 (Inter-RNS hard HO with switching in the CN-single CN) was removed</li> <li>• section 7.2.14.2 (Inter-RNS cell Update via Iur) was added</li> <li>• section 7.2.15.2.1 (Inter-RNS URA Update via Iur) was added</li> <li>• section 7.2.13.2 (Inter-RNS Hard HO via Iur) was re-integrated and filled with new contributions</li> </ul>
March 1 <sup>st</sup> 1999	0.0.2	<p>The correct first pages common for 3GPP were introduced (first page, copyright, etc)</p> <p>Revision marks are referred to the modification introduced to the document AFTER the TSG-RAN WG3 first meeting – Bon February 99, based on the minor comments received in line with the decision of the previous meeting, (i.e. comments to the first draft merged version are identified)</p> <p>In this version the revision mark referred to version 0.0.0 were accepted</p>

February 15 <sup>th</sup> 1999	0.0.1	<p>This version includes also the modification agreed at the TSG-RAN WG3 first meeting based on new contributions</p> <p>Notes</p> <ul style="list-style-type: none"> <li>• The general information dealing with references and copyrights are not updated to the 3GPP ones (To be introduced when available)</li> <li>• The graphical look of the parts included from the TTC/ARIB document still to be aligned by the editor to the rest of the document (the content is supposed to be aligned)</li> </ul>
February 4 <sup>th</sup> 1999	0.0.0	<p>First draft version based on merge of the corresponding ETSI and TTC/ARIB document as agreed at the TSG-RAN WG3 first meeting – Bon February 99. (Revision marks are referred to the ETSI one).</p> <p>This version includes also the modification agreed at the TSG-RAN WG3 first meeting based on new contributions (except document 54 and 55, from which is expected an electronic version with the agreed modifications from the authors)</p> <p>Notes</p> <ul style="list-style-type: none"> <li>• The general information dealing with references and copyrights are not updated to the 3GPP ones (To be introduced when available)</li> <li>• Alignment of names of messages respect to the Iur and Iub ETSI/ARIB merged interfaces is not complete. (To be introduced/checked later when the correspondent documents will be available in order to limit misalignment)</li> <li>• The graphical look of the parts included from the TTC/ARIB document still to be aligned by the editor to the rest of the document (the content is supposed to be aligned)</li> </ul>
Reporter for I3.01 is:		
<p>Enrico Scarrone  CSELT  Tel. : +39 011 228 7084  Fax : +39 011 228 5520  Email : <a href="mailto:Enrico.Scarrone@cse.lt.it">Enrico.Scarrone@cse.lt.it</a></p>		
This document is written in Microsoft Word version 97.		

## ~~10.ANNEX: status of the document~~

- ~~1. Intellectual Property Rights ————— TO BE FILLED (BY STAFF?)~~
- ~~2. Foreword ————— TO BE FILLED (BY STAFF?)~~
- ~~3. Scope ————— TO BE UPDATED? (PRESENTLY IT IS A VERY SHORT DESCRIPTION)~~
- ~~4. References ————— TO BE UPDATED~~
- ~~5. Definitions, abbreviations and notation ————— TO BE UPDATED~~
  - ~~5.3 Notation for the signalling procedures ————— COMPLETED~~
- ~~6. UTRAN AND UE PROTOCOL ARC... ————— TO BE UPDATED~~
- ~~7. UTRAN Signaling Procedures ————— TO BE UPDATED (IT IS ONLY A FOREWORD FOR THE NEXT TWO CHAPTER)~~
- ~~8. Procedures not related to a specific UE (global procedures)~~
  - ~~8.1 System Information Broadcasting ————— STABLE,MISSING TEXT (CONTRIBUTION INVITED)~~
  - ~~8.2 Cell Broadcast ————— NOT STABLE (CONTRIBUTION INVITED)~~
- ~~9. Procedures related to a specific UE~~
  - ~~9.1 Paging~~
    - ~~9.1.1 Paging for a UE in RRC Idle Mode STABLE~~
    - ~~9.1.2 Paging for a UE in RRC Conn... ————— STABLE~~
  - ~~9.2 NAS Signalling Connection Establishment~~
    - ~~9.2.1 UE Initiated Signalling Connection Est.. — STABLE~~
    - ~~9.2.2 CN Initiated Signalling Connection Est.. — NOT STABLE,MISSING FLOW AND TEXT (CONTRIBUTION INVITED)~~
  - ~~9.3 RRC Connection Establishment~~
    - ~~9.3.1 DCH Establishment ————— STABLE~~
    - ~~9.3.2 RACH/FACH Establishment ————— STABLE (MISSING REFERENCE)~~
  - ~~9.4 RRC Connection Release —————~~
    - ~~9.4.1 DCH Release ————— STABLE,MISSING TEXT (CONTRIBUTION INVITED)~~
    - ~~9.4.2 Common Transport Channel Release — STABLE,MISSING TEXT (CONTRIBUTION INVITED)~~
  - ~~9.5 RRC Connection Re-establishment~~
    - ~~9.5.1 DCH Re-establishment ————— NOT STABLE (CONTRIBUTION INVITED)~~
    - ~~9.5.2 RACH/FACH Re-establishment ————— NOT STABLE (CONTRIBUTION INVITED)~~
  - ~~9.6 Radio Access Bearer Establishment —~~
    - ~~9.6.1 DCH DCH Establishment Sync.. — STABLE~~
    - ~~9.6.2 DCH DCH Establishment Unsyn.. STABLE~~
    - ~~9.6.3 RACH/FACH DCH Establishment — STABLE,MISSING TEXT (CONTRIBUTION INVITED)~~

- 9.6.4 RACH/FACH RACH/FACH Est.. STABLE,MISSING TEXT (CONTRIBUTION INVITED)
- 9.7 Radio Access Bearer Release
- 9.7.1 DCH DCH Release Synchronized SABLE
- 9.7.2 DCH DCH Release Unsynchronized STABLE
- 9.7.3 DCH RACH/FACH Release NOT STABLE (CONTRIBUTION INVITED)
- 9.7.4 RACH/FACH RACH/FACH Release STABLE,MISSING TEXT (CONTRIBUTION INVITED)
- 9.8 Radio Access Bearer Re-establishment NOT STABLE (CONTRIBUTION INVITED)
- 9.9 Radio Access Bearer Modification NOT STABLE (CONTRIBUTION INVITED)
- 9.10 Physical Channel Reconfiguration NOT STABLE (CONTRIBUTION INVITED)
- 9.11 Channel Type Switching
- 9.11.1 RACH/PCH to RACH/FACH STABLE, MISSING TEXT (CONTRIBUTION INVITED)
- 9.11.2 RACH/FACH to RACH/PCH STABLE (MISSING REFERENCE)
- 9.11.3 RACH/FACH to DCH STABLE, MISSING TEXT (CONTRIBUTION INVITED)
- 9.11.4 DCH to RACH/FACH NOT STABLE (CONTRIBUTION INVITED)
- 9.12 Soft Handover STABLE
- 9.13 Hard Handover
- 9.13.1 Backward Handover
- 9.13.1.1 Intra Node B Hard Handover STABLE, MISSING TEXT (CONTRIBUTION INVITED)
- 9.13.1.2 Hard Handover via .. NOT STABLE (CONTRIBUTION INVITED)
- 9.13.1.3 Hard Handover with swite.. NOT STABLE (CONTRIBUTION INVITED)
- 9.13.2 Forward Handover NOT STABLE (CONTRIBUTION INVITED)
- 9.15 HO between UTRAN and GSM/BSS
- 9.15.1 UTRAN to GSM/BSS STABLE
- 9.15.2 GSM/BSS to UTRAN STABLE
- 9.15.3 UTRAN to GPRS NOT STABLE (CONTRIBUTION INVITED)
- 9.15.4 UTRAN to GSM/BSS NOT STABLE (CONTRIBUTION INVITED)
- 9.16 Load Indication NOT STABLE (CONTRIBUTION INVITED)
- 9.17 Ciphering NOT STABLE (CONTRIBUTION INVITED)
- 9.18 Transport CH Reconfiguration
- 9.18.1 Transport CH Reconfiguration.. STABLE, MISSING TEXT (CONTRIBUTION INVITED)
- 9.18.2 Transport CH Reconfiguration.. NOT STABLE (CONTRIBUTION INVITED)
- 9.18.3 Transport CH Reconfiguration.. STABLE, MISSING TEXT (CONTRIBUTION INVITED)
- 9.18.4 Transport CH Reconfiguratio.. NOT STABLE (CONTRIBUTION INVITED)
- 9.19 Notification NOT STABLE (CONTRIBUTION INVITED)





<u>9.3.2</u>				<u>X</u>			<u>X</u>
<u>9.4.1</u>		<u>X</u>			<u>X</u>	<u>X</u>	
<u>9.4.2</u>		<u>X</u>			<u>X</u>	<u>X</u>	
<u>9.5.1.1</u>							<u>X</u>
<u>9.5.1.2</u>			<u>X</u>			<u>X</u>	
<u>9.5.2</u>	<u>X</u>						
<u>9.6.1</u>							<u>X</u>
<u>9.6.2</u>							<u>X</u>
<u>9.6.3</u>		<u>X</u>			<u>X</u>	<u>X</u>	
<u>9.6.4</u>		<u>X</u>			<u>X</u>	<u>X</u>	
<u>9.7.1</u>							<u>X</u>
<u>9.7.2</u>							<u>X</u>
<u>9.7.3</u>	<u>X</u>						
<u>9.7.4</u>		<u>X</u>			<u>X</u>	<u>X</u>	
<u>9.8</u>	<u>X</u>						
<u>9.9.1</u>	<u>X</u>						
<u>9.9.2</u>		<u>X</u>			<u>X</u>		
<u>9.9.3</u>		<u>X</u>			<u>X</u>		
<u>9.9.4</u>		<u>X</u>			<u>X</u>		
<u>9.10.1</u>			<u>X</u>			<u>X</u>	
<u>9.10.2</u>			<u>X</u>			<u>X</u>	
<u>9.11.1</u>		<u>X</u>			<u>X</u>	<u>X</u>	
<u>9.11.2</u>				<u>X</u>			<u>X</u>
<u>9.11.3</u>		<u>X</u>			<u>X</u>	<u>X</u>	
<u>9.11.4</u>	<u>X</u>						
<u>9.12.1</u>							<u>X</u>
<u>9.12.2</u>							<u>X</u>
<u>9.12.3</u>							<u>X</u>
<u>9.13.1.1</u>		<u>X</u>	<u>X</u>		<u>X</u>	<u>X</u>	
<u>9.13.1.2</u>		<u>X</u>			<u>X</u>		
<u>9.13.1.3</u>			<u>X</u>				<u>X</u>
<u>9.13.1.4</u>			<u>X</u>				<u>X</u>
<u>9.13.2.1</u>			<u>X</u>			<u>X</u>	

<u>9.13.2.2</u>			<u>X</u>			<u>X</u>	
<u>9.13.2.3</u>			<u>X</u>			<u>X</u>	
<u>9.14.1</u>			<u>X</u>				<u>X</u>
<u>9.14.2</u>			<u>X</u>				<u>X</u>
<u>9.14.3</u>			<u>X</u>				<u>X</u>
<u>9.15.1</u>							<u>X</u>
<u>9.15.2</u>							<u>X</u>
<u>9.15.3</u>			<u>X</u>			<u>X</u>	
<u>9.15.4</u>			<u>X</u>			<u>X</u>	
<u>9.15.5</u>			<u>X</u>			<u>X</u>	
<u>9.16</u>	<u>X</u>						
<u>9.17</u>	<u>X</u>						
<u>9.18.1.1</u>			<u>X</u>			<u>X</u>	
<u>9.18.1.2</u>			<u>X</u>			<u>X</u>	
<u>9.18.2</u>		<u>X</u>			<u>X</u>		
<u>9.18.3</u>		<u>X</u>			<u>X</u>	<u>X</u>	
<u>9.18.4</u>		<u>X</u>			<u>X</u>		
<u>9.19</u>		<u>X</u>			<u>X</u>		
<u>9.20</u>		<u>X</u>			<u>X</u>		
<u>9.21.1</u>		<u>X</u>			<u>X</u>	<u>X</u>	
<u>9.21.2</u>		<u>X</u>			<u>X</u>	<u>X</u>	
<u>9.22</u>		<u>X</u>			<u>X</u>	<u>X</u>	